

Optocoupler, Phototransistor Output (Dual, Quad Channel)

Dual Channel

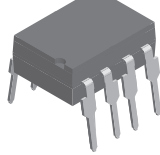

Quad Channel

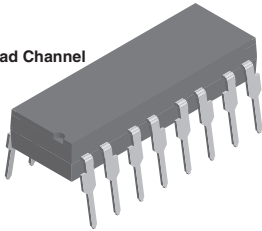

i179012-1

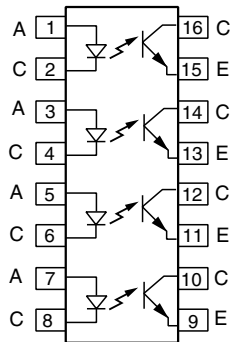
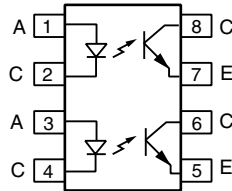

i179052-2



FEATURES

- Identical channel to channel footprint
- Dual and quad packages feature:
 - Reduced board space
 - Lower pin and parts count
 - Better channel to channel CTR match
 - Improved common mode rejection
- Isolation test voltage from double molded package, 5300 V_{RMS}
- Compliant to RoHS Directive 2002/95/EC and in accordance to WEEE 2002/96/EC

RoHS
COMPLIANT

AGENCY APPROVALS

- UL1577, file no. E52744 system code H, double protection
- CSA 93751
- BSI IEC 60950; IEC 60065
- DIN EN 60747-5-2 (VDE0884)/DIN EN 60747-5-5 pending, available with option 1

DESCRIPTION

The ILD615, ILQ615 are multi-channel phototransistor optocouplers that use GaAs IRLED emitters and high gain NPN phototransistors. These devices are constructed using over/under leadframe optical coupling and double molded insulation technology resulting a withstand test voltage of 7500 V_{ACPEAK} and a working voltage of 1700 V_{RMS}.

The binned min./max. and linear CTR characteristics make these devices well suited for DC or AC voltage detection. Eliminating the phototransistor base connection provides added electrical noise immunity from the transients found in many industrial control environments.

Because of guaranteed maximum non-saturated and saturated switching characteristics, the ILD615, ILQ615 can be used in medium speed data I/O and control systems. The binned min./max. CTR specification allow easy worst case interface calculations for both level detection and switching applications. Interfacing with a CMOS logic is enhanced by the guaranteed CTR at I_F = 1 mA.

ILD615, ILQ615



Vishay Semiconductors Optocoupler, Phototransistor Output
(Dual, Quad Channel)

ORDERING INFORMATION

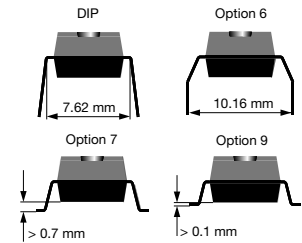
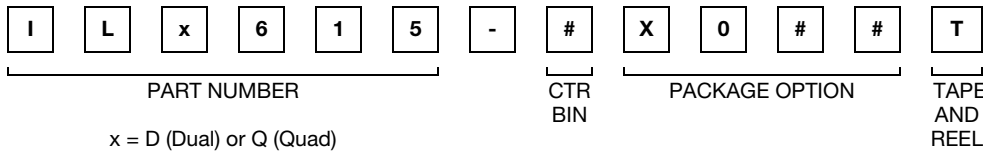

AGENCY CERTIFIED/PACKAGE	DUAL CHANNEL				QUAD CHANNEL			
	CTR (%)							
	10 mA							
UL, CSA, BSI, VDE	40 to 80	63 to 125	100 to 200	160 to 320	40 to 80	63 to 125	100 to 200	160 to 320
DIP-8	ILD615-1	ILD615-2	ILD615-3	ILD615-4	-	-	-	-
DIP-8, 400 mil, option 6	-	-	-	ILD615-4X006	-	-	-	-
SMD-8, option 7	ILD615-1X007T	-	-	-	-	-	-	-
SMD-8, option 9	ILD615-1X009	ILD615-2X009T ⁽¹⁾	ILD615-3X009T	ILD615-4X009T ⁽¹⁾	-	-	-	-
DIP-16	-	-	-	-	ILQ615-1	ILQ615-2	ILQ615-3	ILQ615-4
SMD-16, option 7	-	-	-	-	-	ILQ615-2X007	ILQ615-3X007T ⁽¹⁾	ILQ615-4X007
SMD-16, option 9	-	-	-	-	ILQ615-1X009	-	ILQ615-3X009T ⁽¹⁾	ILQ615-4X009T ⁽¹⁾
VDE	40 to 80	63 to 125	100 to 200	160 to 320	40 to 80	63 to 125	100 to 200	160 to 320
DIP-8	-	ILD615-2X001	-	ILD615-4X001	-	-	-	-
DIP-8, 400 mil, option 6	-	ILD615-2X016	ILD615-3X016	ILD615-4X016	-	-	-	-
SMD-8, option 7	-	-	ILD615-3X017T ⁽¹⁾	-	-	-	-	-
DIP-16	-	-	-	-	-	-	ILQ615-3X001	ILQ615-4X001
DIP-16, 400 mil, option 6	-	-	-	-	-	-	ILQ615-3X016	-
SMD-16, option 7	-	-	-	-	-	ILQ615-2X017	-	-

Notes

- Also available in tubes; do not add T to end.
- Additional options may be possible, please contact sales office.

ABSOLUTE MAXIMUM RATINGS (T_{amb} = 25 °C, unless otherwise specified)

PARAMETER	TEST CONDITION	SYMBOL	VALUE	UNIT
INPUT				
Reverse voltage		V _R	6	V
Forward current		I _F	60	mA
Surge current		I _{FSM}	1.5	A
Power dissipation		P _{diss}	100	mW
Derate linearly from 25 °C			1.33	mW/°C
OUTPUT				
Collector emitter breakdown voltage		BV _{CEO}	70	V
Emitter collector breakdown voltage		BV _{ECO}	7	V
Collector current		I _C	50	mA
	t < 1 ms	I _C	100	mA
Power dissipation		P _{diss}	150	mW
Derate linearly from 25 °C			2	mW/°C



ABSOLUTE MAXIMUM RATINGS ($T_{amb} = 25\text{ }^{\circ}\text{C}$, unless otherwise specified)				
PARAMETER	TEST CONDITION	SYMBOL	VALUE	UNIT
COUPLER				
Storage temperature		T_{stg}	- 55 to + 150	$^{\circ}\text{C}$
Operating temperature		T_{amb}	- 55 to + 100	$^{\circ}\text{C}$
Junction temperature		T_j	100	$^{\circ}\text{C}$
Soldering temperature ⁽¹⁾	2 mm distance from case bottom	T_{sld}	260	$^{\circ}\text{C}$
Package power dissipation ILD615			400	mW
Derate linearly from 25 $^{\circ}\text{C}$			5.33	mW/ $^{\circ}\text{C}$
Package power dissipation ILQ615			500	mW
Derate linearly from 25 $^{\circ}\text{C}$			6.67	mW/ $^{\circ}\text{C}$
Isolation test voltage	$t = 1\text{ s}$	V_{ISO}	5300	V_{RMS}
Isolation voltage		V_{IORM}	890	V_P
Total power dissipation		P_{tot}	250	mW
Creepage distance			≥ 7	mm
Clearance distance			≥ 7	mm
Isolation resistance	$V_{IO} = 500\text{ V}, T_{amb} = 25\text{ }^{\circ}\text{C}$	R_{IO}	$\geq 10^{12}$	Ω
	$V_{IO} = 500\text{ V}, T_{amb} = 100\text{ }^{\circ}\text{C}$	R_{IO}	$\geq 10^{11}$	Ω

Notes

- Stresses in excess of the absolute maximum ratings can cause permanent damage to the device. Functional operation of the device is not implied at these or any other conditions in excess of those given in the operational sections of this document. Exposure to absolute maximum ratings for extended periods of the time can adversely affect reliability.

⁽¹⁾ Refer to reflow profile for soldering conditions for surface mounted devices (SMD). Refer to wave profile for soldering conditions for through hole devices (DIP).

ELECTRICAL CHARACTERISTICS ($T_{amb} = 25\text{ }^{\circ}\text{C}$, unless otherwise specified)						
PARAMETER	TEST CONDITION	SYMBOL	MIN.	TYP.	MAX.	UNIT
INPUT						
Forward voltage	$I_F = 10\text{ mA}$	V_F	1	1.15	1.3	V
Breakdown voltage	$I_R = 10\text{ }\mu\text{A}$	V_{BR}	6	30		V
Reverse current	$V_R = 6\text{ V}$	I_R		0.01	10	μA
Capacitance	$V_R = 0\text{ V}, f = 1\text{ MHz}$	C_O		25		pF
Thermal resistance, junction to lead		R_{THJL}		750		K/W
OUTPUT						
Collector emitter capacitance	$V_{CE} = 5\text{ V}, f = 1\text{ MHz}$	C_{CE}		6.8		pF
Collector emitter leakage current, -1, -2	$V_{CE} = 10\text{ V}$	I_{CEO}		2	50	nA
Collector emitter leakage current, -3, -4	$V_{CE} = 10\text{ V}$	I_{CEO}		5	100	nA
Collector emitter breakdown voltage	$I_{CE} = 0.5\text{ mA}$	BV_{CEO}	70			V
Emitter collector breakdown voltage	$I_E = 0.1\text{ mA}$	BV_{ECO}	7			V
Thermal resistance, junction to lead		R_{THJL}		500		K/W
PACKAGE TRANSFER CHARACTERISTICS						
Channel/channel CTR match	$I_F = 10\text{ mA}, V_{CE} = 5\text{ V}$	CTR _X /CTR _Y	1 to 1		2 to 1	
COUPLER						
Capacitance (input to output)	$V_{IO} = 0\text{ V}, f = 1\text{ MHz}$	C_{IO}		0.8		pF
Insulation resistance	$V_{IO} = 500\text{ V}, T_A = 25\text{ }^{\circ}\text{C}$	R_S	10^{12}	10^{14}		Ω
Channel to channel isolation			500			VAC

Note

- Minimum and maximum values are tested requirements. Typical values are characteristics of the device and are the result of engineering evaluations. Typical values are for information only and are not part of the testing requirements.

CURRENT TRANSFER RATIO ($T_{amb} = 25\text{ }^{\circ}\text{C}$, unless otherwise specified)							
PARAMETER	TEST CONDITION	PART	SYMBOL	MIN.	TYP.	MAX.	UNIT
Current transfer ratio (collector emitter saturated)	$I_F = 10\text{ mA}$, $V_{CE} = 0.4\text{ V}$	ILD615-1	CTR_{CEsat}		25		%
		ILQ615-1					
		ILD615-2	CTR_{CEsat}				
		ILQ615-2					
		ILD615-3	CTR_{CEsat}				
		ILQ615-3					
		ILD615-4	CTR_{CEsat}				
		ILQ615-4					
Current transfer ratio (collector emitter)	$I_F = 1\text{ mA}$, $V_{CE} = 5\text{ V}$	ILD615-1	CTR_{CE}	13	30		%
		ILQ615-1					
		ILD615-2	CTR_{CE}				
		ILQ615-2					
		ILD615-3	CTR_{CE}				
		ILQ615-3					
		ILD615-4	CTR_{CE}				
		ILQ615-4					
	$I_F = 10\text{ mA}$, $V_{CE} = 5\text{ V}$	ILD615-1	CTR_{CE}	40	60	80	%
		ILQ615-1					
		ILD615-2	CTR_{CE}				
		ILQ615-2					
		ILD615-3	CTR_{CE}				
		ILQ615-3					
ILD615-4	CTR_{CE}						
ILQ615-4							

SAFETY AND INSULATION RATED PARAMETERS						
PARAMETER	TEST CONDITION	SYMBOL	MIN.	TYP.	MAX.	UNIT
Partial discharge test voltage - routine test	100 %, $t_{test} = 1\text{ s}$	V_{pd}	1.669			kV
Partial discharge test voltage - lot test (sample test)	$t_{Tr} = 60\text{ s}$, $t_{test} = 10\text{ s}$, (see figure 2)	V_{IOTM}	10			kV
		V_{pd}	1.424			kV
Insulation resistance	$V_{IO} = 500\text{ V}$	R_{IO}	10^{12}			Ω
	$V_{IO} = 500\text{ V}$, $T_{amb} = 100\text{ }^{\circ}\text{C}$	R_{IO}	10^{11}			Ω
	$V_{IO} = 500\text{ V}$, $T_{amb} = 175\text{ }^{\circ}\text{C}$ (construction test only)	R_{IO}	10^9			Ω
Forward current		I_{SI}			275	mA
Power dissipation		P_{SO}			400	mW
Rated impulse voltage		V_{IOTM}			10	kV
Safety temperature		T_{SI}			175	$^{\circ}\text{C}$

Note

- According to DIN EN 60747-5-2 (see figure 2). This optocoupler is suitable for safe electrical isolation only within the safety ratings. Compliance with the safety ratings shall be ensured by means of suitable protective circuits.

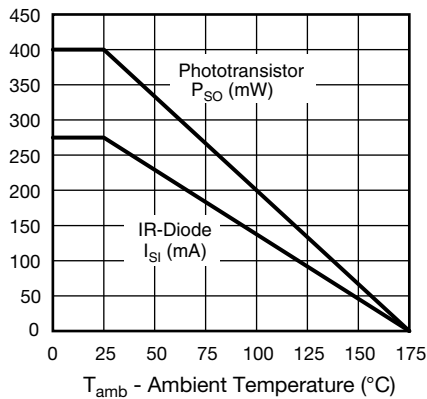
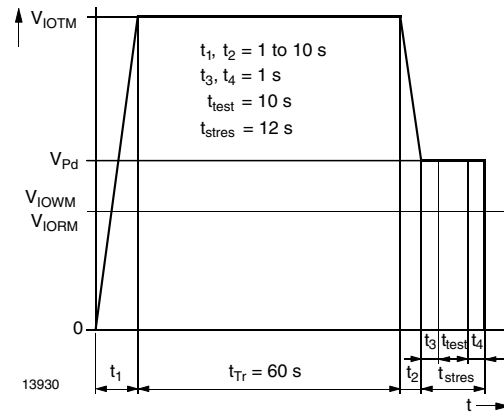

Fig. 1 - Derating Diagram

 Fig. 2 - Test Pulse Diagram for Sample Test according to
 DIN EN 60747-5-2 (VDE0884); IEC60747-5-5

SWITCHING CHARACTERISTICS ($T_{amb} = 25\text{ }^{\circ}\text{C}$, unless otherwise specified)							
PARAMETER	TEST CONDITION	PART	SYMBOL	MIN.	TYP.	MAX.	UNIT
NON-SATURATED							
Current	$V_{CC} = 5\text{ V}$, $R_L = 75\ \Omega$, 50 % of V_{PP}		I_F		10		mA
Turn-on time	$V_{CC} = 5\text{ V}$, $R_L = 75\ \Omega$, 50 % of V_{PP}		t_{on}		3		μs
Rise time	$V_{CC} = 5\text{ V}$, $R_L = 75\ \Omega$, 50 % of V_{PP}		t_r		2		μs
Turn-off time	$V_{CC} = 5\text{ V}$, $R_L = 75\ \Omega$, 50 % of V_{PP}		t_{off}		2.3		μs
Fall time	$V_{CC} = 5\text{ V}$, $R_L = 75\ \Omega$, 50 % of V_{PP}		t_f		2		μs
Propagation H to L	$V_{CC} = 5\text{ V}$, $R_L = 75\ \Omega$, 50 % of V_{PP}		t_{PHL}		1.1		μs
Propagation L to H	$V_{CC} = 5\text{ V}$, $R_L = 75\ \Omega$, 50 % of V_{PP}		t_{PLH}		2.5		μs
SATURATED							
Current	$V_{CC} = 5\text{ V}$, $R_L = 1\text{ k}\Omega$, $V_{TH} = 1.5\text{ V}$	ILD615-1	I_F		20		mA
		ILQ615-1					
		ILD615-2	I_F		10		mA
		ILQ615-2					
		ILD615-3	I_F		10		mA
		ILQ615-3					
ILD615-4	I_F		5		mA		
ILQ615-4							
Turn-on time	$V_{CC} = 5\text{ V}$, $R_L = 1\text{ k}\Omega$, $V_{TH} = 1.5\text{ V}$	ILD615-1	t_{on}		3		μs
		ILQ615-1					
		ILD615-2	t_{on}		4.3		μs
		ILQ615-2					
		ILD615-3	t_{on}		4.3		μs
		ILQ615-3					
ILD615-4	t_{on}		6		μs		
ILQ615-4							

SWITCHING CHARACTERISTICS ($T_{amb} = 25\text{ }^{\circ}\text{C}$, unless otherwise specified)							
PARAMETER	TEST CONDITION	PART	SYMBOL	MIN.	TYP.	MAX.	UNIT
SATURATED							
Rise time	$V_{CC} = 5\text{ V}$, $R_L = 1\text{ k}\Omega$, $V_{TH} = 1.5\text{ V}$	ILD615-1	t_r		2		μs
		ILQ615-1					
		ILD615-2	t_r		2.8		μs
		ILQ615-2					
		ILD615-3	t_r		2.8		μs
		ILQ615-3					
ILD615-4	t_r		4.6		μs		
ILQ615-4							
Turn-off time	$V_{CC} = 5\text{ V}$, $R_L = 1\text{ k}\Omega$, $V_{TH} = 1.5\text{ V}$	ILD615-1	t_{off}		18		μs
		ILQ615-1					
		ILD615-2	t_{off}		25		μs
		ILQ615-2					
		ILD615-3	t_{off}		25		μs
		ILQ615-3					
ILD615-4	t_{off}		25		μs		
ILQ615-4							
Fall time	$V_{CC} = 5\text{ V}$, $R_L = 1\text{ k}\Omega$, $V_{TH} = 1.5\text{ V}$	ILD615-1	t_f		11		μs
		ILQ615-1					
		ILD615-2	t_f		14		μs
		ILQ615-2					
		ILD615-3	t_f		14		μs
		ILQ615-3					
ILD615-4	t_f		15		μs		
ILQ615-4							
Propagation H to L	$V_{CC} = 5\text{ V}$, $R_L = 1\text{ k}\Omega$, $V_{TH} = 1.5\text{ V}$	ILD615-1	t_{PHL}		1.6		μs
		ILQ615-1					
		ILD615-2	t_{PHL}		2.6		μs
		ILQ615-2					
		ILD615-3	t_{PHL}		2.6		μs
		ILQ615-3					
ILD615-4	t_{PHL}		5.4		μs		
ILQ615-4							
Propagation L to H	$V_{CC} = 5\text{ V}$, $R_L = 1\text{ k}\Omega$, $V_{TH} = 1.5\text{ V}$	ILD615-1	t_{PLH}		8.6		μs
		ILQ615-1					
		ILD615-2	t_{PLH}		7.2		μs
		ILQ615-2					
		ILD615-3	t_{PLH}		7.2		μs
		ILQ615-3					
ILD615-4	t_{PLH}		7.4		μs		
ILQ615-4							

COMMON MODE TRANSIENT IMMUNITY ($T_{amb} = 25\text{ }^{\circ}\text{C}$, unless otherwise specified)							
PARAMETER	TEST CONDITION	SYMBOL	MIN.	TYP.	MAX.	UNIT	
Common mode rejection output high	$V_{CM} = 50\text{ V}_{P-P}$, $R_L = 1\text{ k}\Omega$, $I_F = 0\text{ mA}$	CM_H		5000		$\text{V}/\mu\text{s}$	
Common mode rejection output low	$V_{CM} = 50\text{ V}_{P-P}$, $R_L = 1\text{ k}\Omega$, $I_F = 0\text{ mA}$	CM_L		5000		$\text{V}/\mu\text{s}$	
Common mode coupling capacitance		C_{CM}		0.01		pF	

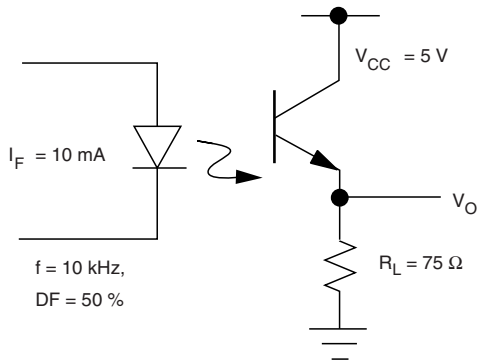
TYPICAL CHARACTERISTICS ($T_{amb} = 25\text{ }^{\circ}\text{C}$, unless otherwise specified)

iild615_01

Fig. 3 - Non-Saturated Switching Timing

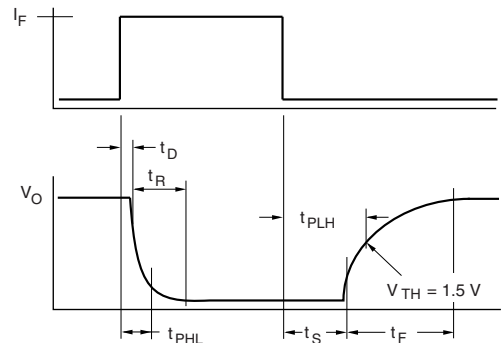

iild615_04

Fig. 6 - Saturated Switching Timing

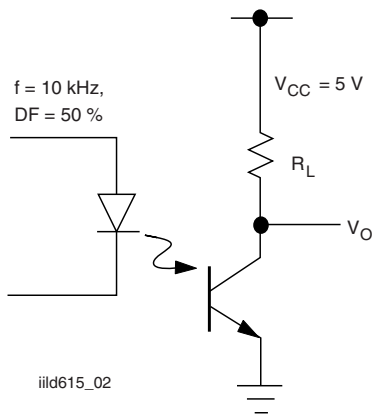

iild615_02

Fig. 4 - Saturated Switching Timing

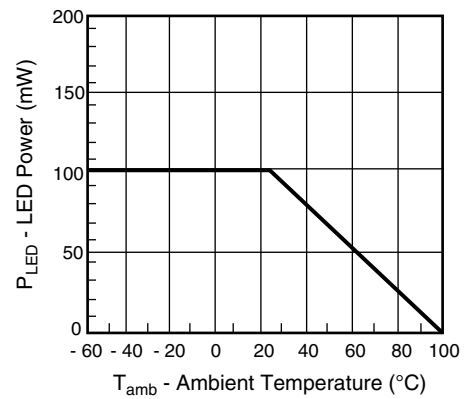
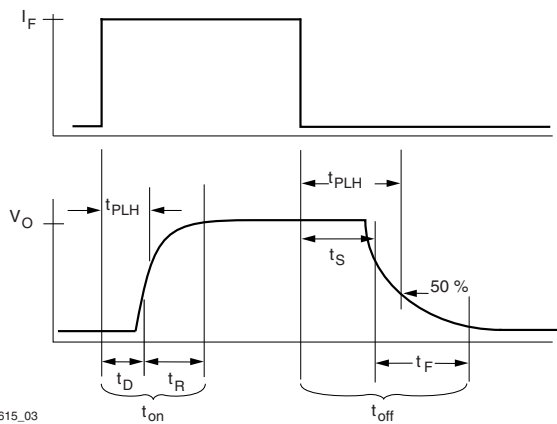
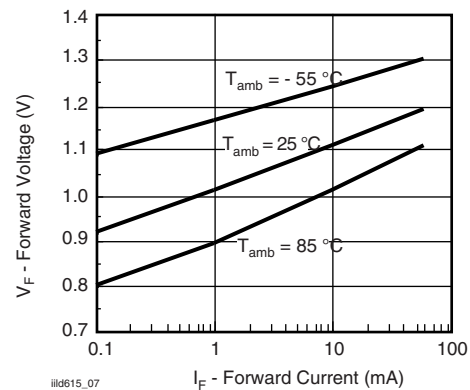

Fig. 7 - Maximum LED Power Dissipation



iild615_03

Fig. 5 - Non-Saturated Switching Timing



iild615_07

Fig. 8 - Forward Voltage vs. Forward Current

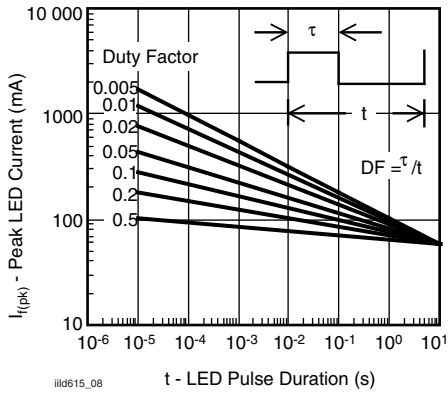

Fig. 9 - Peak LED Current vs. Pulse Duration, τ

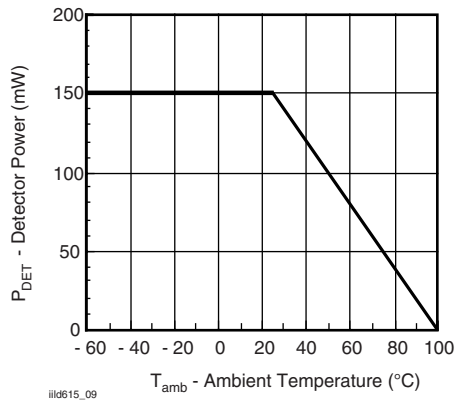

Fig. 10 - Maximum Detector Power Dissipation

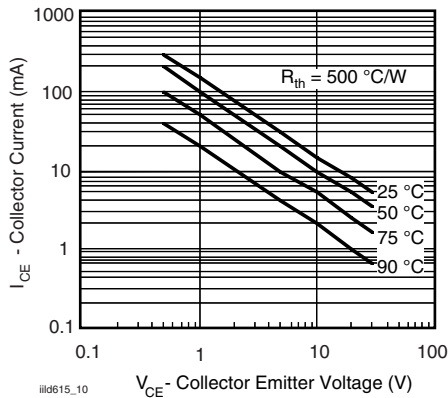

Fig. 11 - Maximum Collector Current vs. Collector Voltage

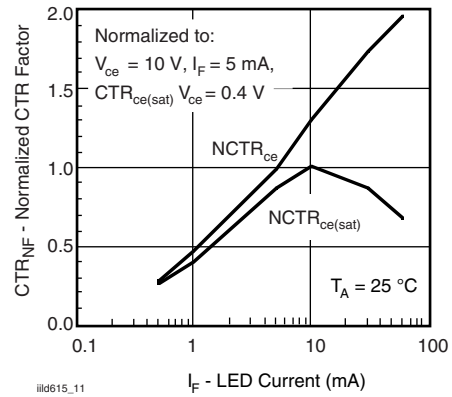

Fig. 12 - Normalization Factor for Non-Saturated and Saturated CTR vs. I_F

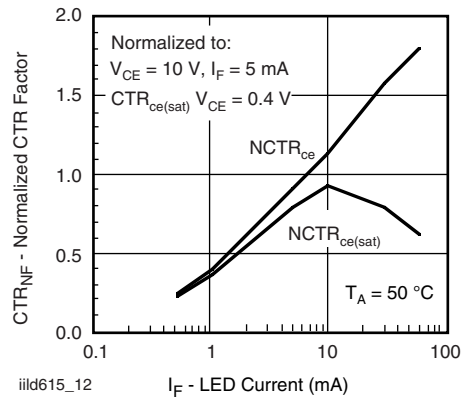

Fig. 13 - Normalization Factor for Non-Saturated and Saturated CTR vs. I_F

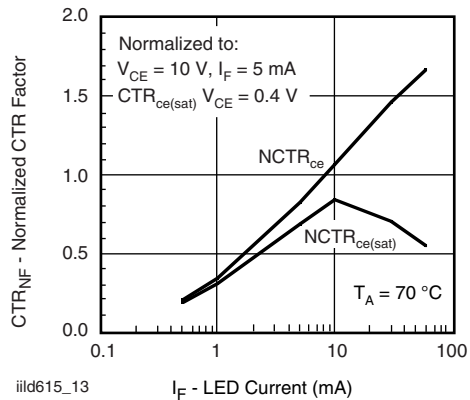

Fig. 14 - Normalization Factor for Non-Saturated and Saturated CTR vs. I_F

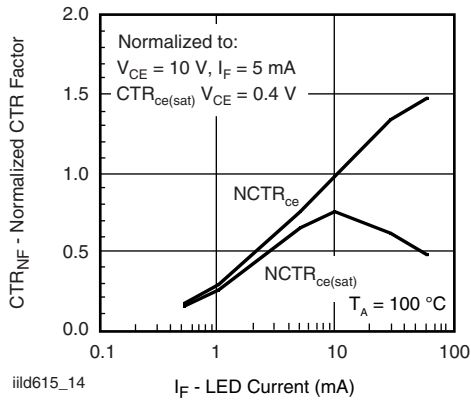

Fig. 15 - Normalization Factor for Non-Saturated and Saturated CTR vs. I_F

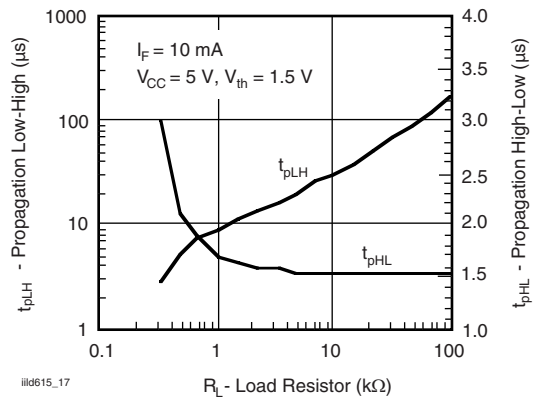

Fig. 18 - -1, Propagation Delay vs. Collector Load Resistor

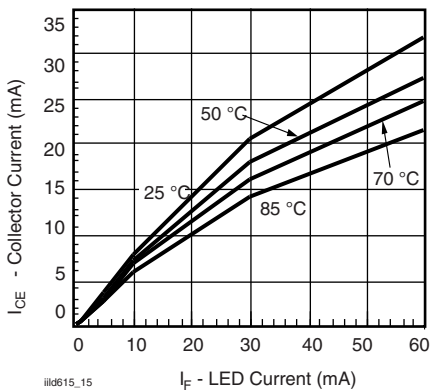

Fig. 16 - Collector Emitter Current vs. Temperature and LED Current

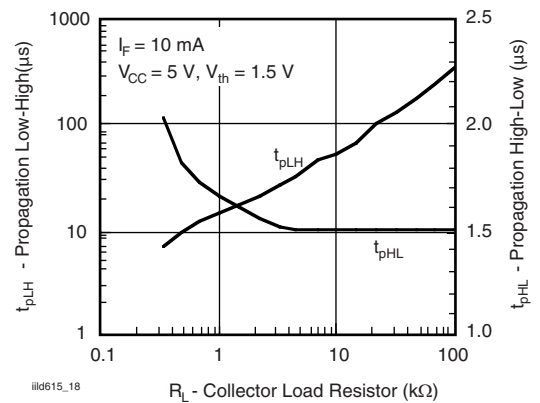

Fig. 19 - -2, -3, Propagation Delay vs. Collector Load Resistor

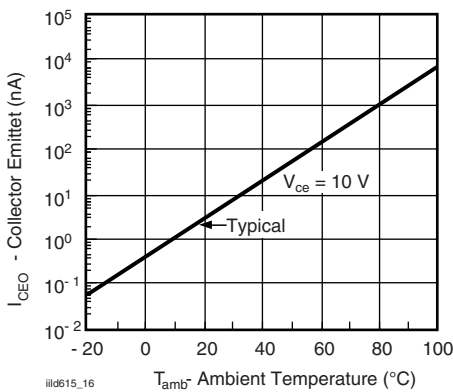

Fig. 17 - Collector Emitter Leakage vs. Temperature

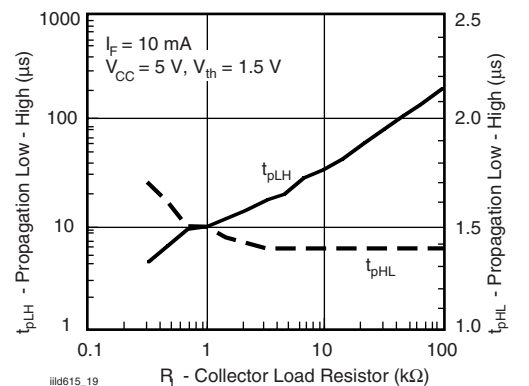

Fig. 20 - -4, Propagation Delay vs. Collector Load Resistor

ILD615, ILQ615



Vishay Semiconductors Optocoupler, Phototransistor Output
(Dual, Quad Channel)

PACKAGE DIMENSIONS in millimeters

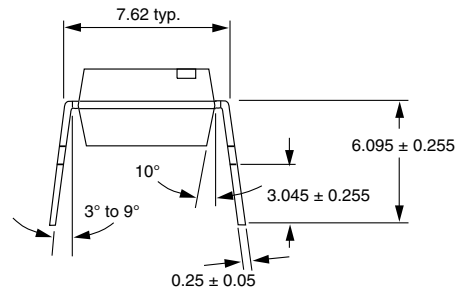
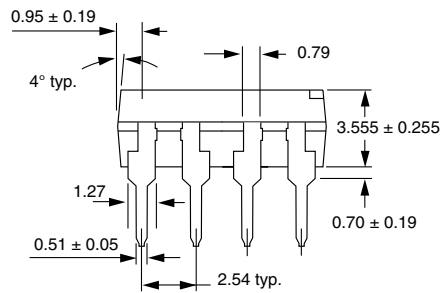
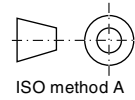
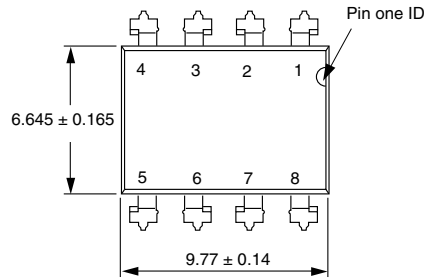

i178006

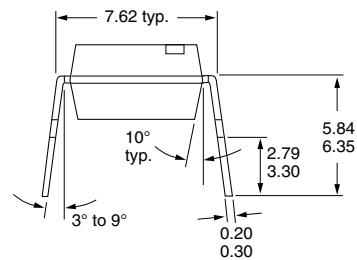
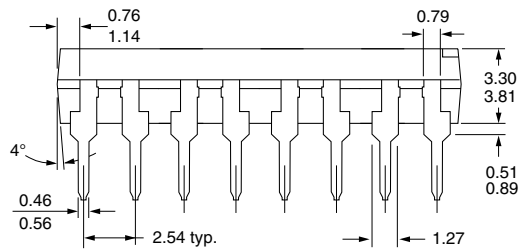
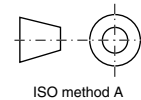
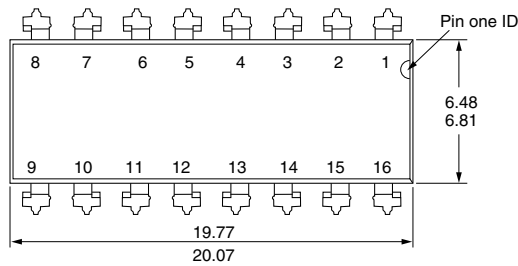

i178007

Option 6

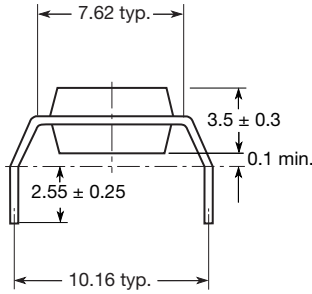

Option 7

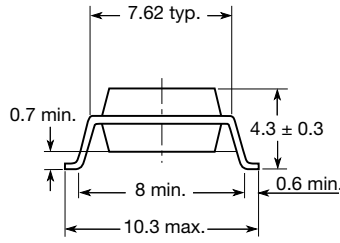

Option 9

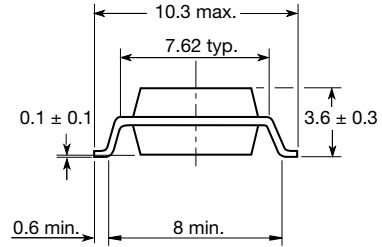

20802-22

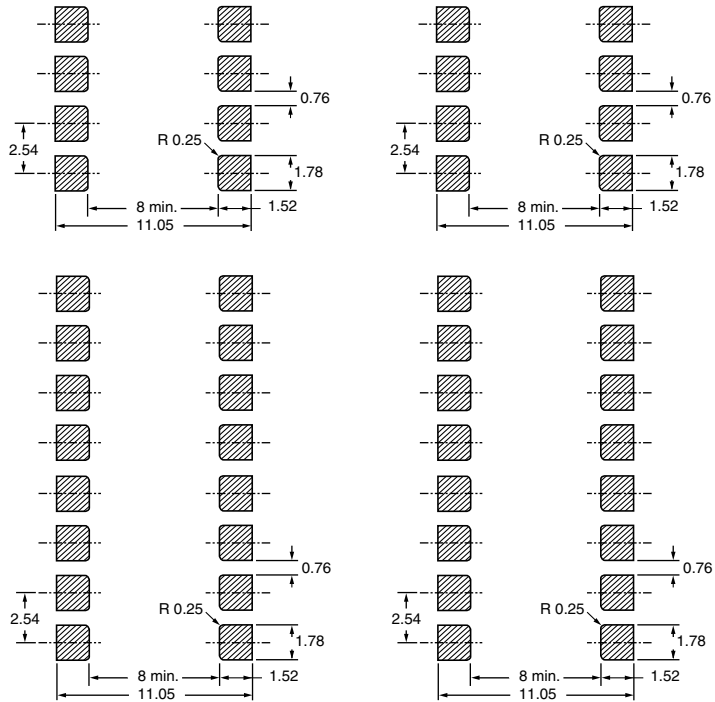

PACKAGE MARKING

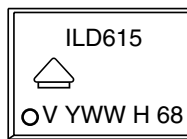

21764-88

Notes

- Only options 1 and 7 reflected in the package marking.
- The VDE Logo is only marked on option1 parts.
- Tape and reel suffix (T) is not part of the package marking.



Disclaimer

ALL PRODUCT, PRODUCT SPECIFICATIONS AND DATA ARE SUBJECT TO CHANGE WITHOUT NOTICE TO IMPROVE RELIABILITY, FUNCTION OR DESIGN OR OTHERWISE.

Vishay Intertechnology, Inc., its affiliates, agents, and employees, and all persons acting on its or their behalf (collectively, "Vishay"), disclaim any and all liability for any errors, inaccuracies or incompleteness contained in any datasheet or in any other disclosure relating to any product.

Vishay makes no warranty, representation or guarantee regarding the suitability of the products for any particular purpose or the continuing production of any product. To the maximum extent permitted by applicable law, Vishay disclaims (i) any and all liability arising out of the application or use of any product, (ii) any and all liability, including without limitation special, consequential or incidental damages, and (iii) any and all implied warranties, including warranties of fitness for particular purpose, non-infringement and merchantability.

Statements regarding the suitability of products for certain types of applications are based on Vishay's knowledge of typical requirements that are often placed on Vishay products in generic applications. Such statements are not binding statements about the suitability of products for a particular application. It is the customer's responsibility to validate that a particular product with the properties described in the product specification is suitable for use in a particular application. Parameters provided in datasheets and/or specifications may vary in different applications and performance may vary over time. All operating parameters, including typical parameters, must be validated for each customer application by the customer's technical experts. Product specifications do not expand or otherwise modify Vishay's terms and conditions of purchase, including but not limited to the warranty expressed therein.

Except as expressly indicated in writing, Vishay products are not designed for use in medical, life-saving, or life-sustaining applications or for any other application in which the failure of the Vishay product could result in personal injury or death. Customers using or selling Vishay products not expressly indicated for use in such applications do so at their own risk. Please contact authorized Vishay personnel to obtain written terms and conditions regarding products designed for such applications.

No license, express or implied, by estoppel or otherwise, to any intellectual property rights is granted by this document or by any conduct of Vishay. Product names and markings noted herein may be trademarks of their respective owners.

Material Category Policy

Vishay Intertechnology, Inc. hereby certifies that all its products that are identified as RoHS-Compliant fulfill the definitions and restrictions defined under Directive 2011/65/EU of The European Parliament and of the Council of June 8, 2011 on the restriction of the use of certain hazardous substances in electrical and electronic equipment (EEE) - recast, unless otherwise specified as non-compliant.

Please note that some Vishay documentation may still make reference to RoHS Directive 2002/95/EC. We confirm that all the products identified as being compliant to Directive 2002/95/EC conform to Directive 2011/65/EU.

Vishay Intertechnology, Inc. hereby certifies that all its products that are identified as Halogen-Free follow Halogen-Free requirements as per JEDEC JS709A standards. Please note that some Vishay documentation may still make reference to the IEC 61249-2-21 definition. We confirm that all the products identified as being compliant to IEC 61249-2-21 conform to JEDEC JS709A standards.

X-ON Electronics

Largest Supplier of Electrical and Electronic Components

Click to view similar products for [Transistor Output Optocouplers](#) category:

Click to view products by [Vishay](#) manufacturer:

Other Similar products are found below :

[LTV-814S-TA](#) [LTV-824HS](#) [LTV-852S](#) [66095-001](#) [6N136-X017T](#) [MCT6-X007](#) [MOC8101-X017T](#) [PS2561A-1-W-A](#) [PS2561B-1-L-A](#)
[PS2561L-1-V-A](#) [MRF658](#) [IL755-1X007](#) [ILD74-X001](#) [ILQ615-2X017](#) [ILQ615-3X016](#) [LDA102S](#) [LDA110S](#) [PS2561-1-V-W-A](#) [PS2561AL-1-V-A](#) [PS2561L1-1-L-A](#) [PS2701A-1-F3-P-A](#) [PS2801-1-F3-P-A](#) [PS2911-1-L-AX](#) [CNY17-2X017](#) [CNY17-4X001](#) [CNY17-4X017](#) [CNY17F-1X007](#) [CNY17F-2X017](#) [CNY17F-4X001](#) [CNY17G-1](#) [LTV-214](#) [LTV-702VB](#) [LTV-733S](#) [LTV-816S-TA](#) [LTV-825S](#) [TCET1113](#) [TCET2100](#)
[4N25-X007T](#) [IL215AT](#) [ILD615-1X007](#) [ILQ2-X007](#) [VOS615A-2T](#) [WPPC-A11066AA](#) [WPPC-A11066AD](#) [WPPC-A11084ASS](#) [WPPC-A21068AA](#) [WPPC-D11066AA](#) [WPPC-D21068ED](#) [WPPC-D410616EA](#) [WPPC-D410616ED](#)