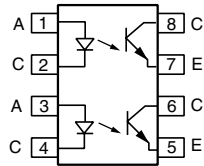
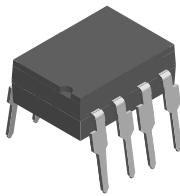
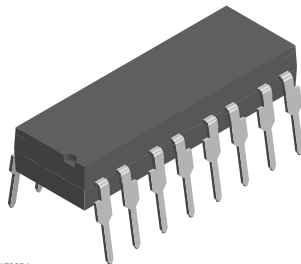
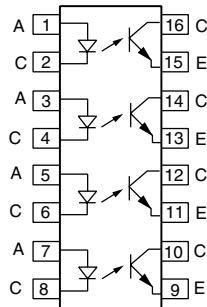

## Optocoupler, Phototransistor Output (Dual, Quad Channel)

**Dual Channel**

**Quad Channel**

H79054

**FEATURES**

- Alternate source to TLP621-2/-4 and TLP621GB-2/-4
- High collector emitter voltage,  $BV_{CEO} = 70\text{ V}$
- Dual and quad packages feature:
  - Lower pin and parts count
  - Better channel to channel CTR match
  - Improved common mode rejection
- Isolation test voltage,  $5300\text{ V}_{RMS}$
- Lead (Pb)-free component
- Component in accordance to RoHS 2002/95/EC and WEEE 2002/96/EC

**RoHS**  
COMPLIANT

**AGENCY APPROVALS**

- UL1577, file no. E52744 system code H or J, double protection
- DIN EN 60747-5-2 (VDE 0884)/DIN EN 60747-5-5 pending available with option 1
- BSI IEC 60950; IEC 60065
- FIMKO

**DESCRIPTION**

The ILD621/ILQ621 and ILD621GB/ILQ621GB are multi-channel phototransistor optocouplers that use GaAs IRLED emitters and high gain NPN silicon phototransistors. These devices are constructed using double molded insulation technology. This assembly process offers a withstand test voltage of 7500 VDC.

The ILD621/ILQ621GB is well suited for CMOS interfacing given the  $CTR_{CEsat}$  of 30 % minimum at  $I_F$  of 1.0 mA. High gain linear operation is guaranteed by a minimum  $CTR_{CE}$  of 100 % at 5.0 mA. The ILD/Q621 has a guaranteed  $CTR_{CE}$  50 % minimum at 5.0 mA. The transparent ion shield insures stable DC gain in applications such as power supply feedback circuits, where constant DC  $V_{IO}$  voltages are present.

**ORDER INFORMATION**

PART	REMARKS
ILD621	CTR > 50 %, dual, DIP-8
ILD621GB	CTR > 100 %, dual, DIP-8
ILQ621	CTR > 50 %, quad, DIP-16
ILQ621GB	CTR > 100 %, quad, DIP-16
ILD621-X006	CTR > 50 %, dual, DIP-8 400 mil

# ILD621/ILD621GB/ILQ621/ILQ621GB



Vishay Semiconductors

Optocoupler, Phototransistor Output  
(Dual, Quad Channel)

ORDER INFORMATION	
PART	REMARKS
ILD621-X007	CTR > 50 %, dual, SMD-8 (option 7)
ILD621-X009	CTR > 50 %, dual, SMD-8 (option 9)
ILD621GB-X007	CTR > 100 %, dual, SMD-8 (option 7)
ILQ621-X006	CTR > 50 %, quad, DIP-16 400 mil
ILQ621-X007	CTR > 50 %, quad, SMD-16 (option 7)
ILQ621-X009	CTR > 50 %, quad, SMD-16 (option 9)
ILQ621GB-X006	CTR > 100 %, quad, DIP-16 400 mil
ILQ621GB-X007	CTR > 100 %, quad, SMD-16 (option 7)
ILQ621GB-X009	CTR > 100 %, quad, SMD-16 (option 9)

**Note**

For additional information on the available options refer to option information.

ABSOLUTE MAXIMUM RATINGS (1)					
PARAMETER	TEST CONDITION	PART	SYMBOL	VALUE	UNIT
<b>INPUT</b>					
Reverse voltage			$V_R$	6.0	V
Forward current			$I_F$	60	mA
Surge current			$I_{FSM}$	1.5	A
Power dissipation			$P_{diss}$	100	mW
Derate from 25 °C				1.33	mW/°C
<b>OUTPUT</b>					
Collector emitter reverse voltage			$V_{ECO}$	70	V
Collector current			$I_C$	50	mA
	$t < 1.0$ ms		$I_C$	100	mA
Power dissipation			$P_{diss}$	150	mW
Derate from 25 °C				- 2.0	mW/°C
<b>COUPLER</b>					
Isolation test voltage	$t = 1.0$ s		$V_{ISO}$	5300	$V_{RMS}$
Package dissipation		ILD621		400	mW
		ILD621GB		400	mW
Derate from 25 °C				5.33	mW/°C
Package dissipation		ILQ621		500	mW
		ILQ621GB		500	mW
Derate from 25 °C				6.67	mW/°C
Creepage distance				$\geq 7.0$	mm
Clearance distance				$\geq 7.0$	mm
Isolation resistance	$V_{IO} = 500$ V, $T_{amb} = 25$ °C		$R_{IO}$	$\geq 10^{12}$	$\Omega$
	$V_{IO} = 500$ V, $T_{amb} = 100$ °C		$R_{IO}$	$\geq 10^{11}$	$\Omega$
Storage temperature			$T_{stg}$	- 55 to + 150	°C
Operating temperature			$T_{amb}$	- 55 to + 100	°C
Junction temperature			$T_j$	100	°C
Soldering temperature (2)	2.0 mm from case bottom		$T_{sld}$	260	°C

**Notes**

(1)  $T_{amb} = 25$  °C, unless otherwise specified.

Stresses in excess of the absolute maximum ratings can cause permanent damage to the device. Functional operation of the device is not implied at these or any other conditions in excess of those given in the operational sections of this document. Exposure to absolute maximum ratings for extended periods of the time can adversely affect reliability.

(2) Refer to reflow profile for soldering conditions for surface mounted devices (SMD). Refer to wave profile for soldering conditions for through hole devices (DIP).



# ILD621/ILD621GB/ILQ621/ILQ621GB

Optocoupler, Phototransistor Output  
(Dual, Quad Channel)

Vishay Semiconductors

ELECTRICAL CHARACTERISTICS							
PARAMETER	TEST CONDITION	PART	SYMBOL	MIN.	TYP.	MAX.	UNIT
<b>INPUT</b>							
Forward voltage	$I_F = 10 \text{ mA}$		$V_F$	1.0	1.15	1.3	V
Reverse current	$V_R = 6.0 \text{ V}$		$I_R$		0.01	10	$\mu\text{A}$
Capacitance	$V_R = 0 \text{ V}, f = 1.0 \text{ MHz}$		$C_O$		40		pF
Thermal resistance, junction to lead			$R_{THJL}$		750		K/W
<b>OUTPUT</b>							
Collector emitter capacitance	$V_{CE} = 5.0 \text{ V}, f = 1.0 \text{ MHz}$		$C_{CE}$		6.8		pF
Collector emitter leakage current	$V_{CE} = 24 \text{ V}$		$I_{CEO}$		10	100	nA
			$I_{CEO}$		20	50	$\mu\text{A}$
Thermal resistance, junction to lead			$R_{THJL}$		500		K/W
<b>COUPLER</b>							
Capacitance (input to output)	$V_{IO} = 0 \text{ V}, f = 1.0 \text{ MHz}$		$C_{IO}$	0.8			pF
Insulation resistance	$V_{IO} = 500 \text{ V}$			$10^{12}$			$\Omega$
Channel to channel insulation				500			VAC
Collector emitter saturation voltage	$I_F = 8.0 \text{ mA}, I_{CE} = 2.4 \text{ mA}$	ILD621	$V_{CEsat}$			0.4	V
		ILQ621					
Collector emitter saturation voltage	$I_F = 1.0 \text{ mA}, I_{CE} = 0.2 \text{ mA}$	ILD621GB	$V_{CEsat}$			0.4	V
		ILQ621GB					

**Note**

$T_{amb} = 25 \text{ }^\circ\text{C}$ , unless otherwise specified.

Minimum and maximum values are testing requirements. Typical values are characteristics of the device and are the result of engineering evaluation. Typical values are for information only and are not part of the testing requirements.

CURRENT TRANSFER RATIO							
PARAMETER	TEST CONDITION	PART	SYMBOL	MIN.	TYP.	MAX.	UNIT
Channel/channel CTR match	$I_F = 5.0 \text{ mA}, V_{CE} = 5.0 \text{ V}$		CTR <sub>X</sub> / CTR <sub>Y</sub>	1 to 1		3 to 1	%
Current transfer ratio (collector emitter saturated)	$I_F = 1.0 \text{ mA}, V_{CE} = 0.4 \text{ V}$	ILD621	CTR <sub>CEsat</sub>		60		%
		ILQ621	CTR <sub>CEsat</sub>		60		%
		ILD621GB	CTR <sub>CEsat</sub>	30			%
		ILQ621GB	CTR <sub>CEsat</sub>	30			%
Current transfer ratio (collector emitter)	$I_F = 5.0 \text{ mA}, V_{CE} = 5.0 \text{ V}$	ILD621	CTR <sub>CE</sub>	50	80	600	%
		ILQ621	CTR <sub>CE</sub>	50	80	600	%
		ILD621GB	CTR <sub>CE</sub>	100	200	600	%
		ILQ621GB	CTR <sub>CE</sub>	100	200	600	%

SWITCHING CHARACTERISTICS							
PARAMETER	TEST CONDITION	SYMBOL	MIN.	TYP.	MAX.	UNIT	
<b>NON-SATURATED</b>							
On time	$I_F = \pm 10 \text{ mA}, V_{CC} = 5.0 \text{ V}, R_L = 75 \Omega, 50 \% \text{ of } V_{PP}$	$t_{on}$		3.0		$\mu\text{s}$	
Rise time	$I_F = \pm 10 \text{ mA}, V_{CC} = 5.0 \text{ V}, R_L = 75 \Omega, 50 \% \text{ of } V_{PP}$	$t_r$		2.0		$\mu\text{s}$	
Off time	$I_F = \pm 10 \text{ mA}, V_{CC} = 5.0 \text{ V}, R_L = 75 \Omega, 50 \% \text{ of } V_{PP}$	$t_{off}$		2.3		$\mu\text{s}$	
Fall time	$I_F = \pm 10 \text{ mA}, V_{CC} = 5.0 \text{ V}, R_L = 75 \Omega, 50 \% \text{ of } V_{PP}$	$t_f$		2.0		$\mu\text{s}$	
Propagation H to L	$I_F = \pm 10 \text{ mA}, V_{CC} = 5.0 \text{ V}, R_L = 75 \Omega, 50 \% \text{ of } V_{PP}$	$t_{PHL}$		1.1		$\mu\text{s}$	
Propagation L to H	$I_F = \pm 10 \text{ mA}, V_{CC} = 5.0 \text{ V}, R_L = 75 \Omega, 50 \% \text{ of } V_{PP}$	$t_{PLH}$		2.5		$\mu\text{s}$	

SWITCHING CHARACTERISTICS						
PARAMETER	TEST CONDITION	SYMBOL	MIN.	TYP.	MAX.	UNIT
<b>SATURATED</b>						
On time	$I_F = \pm 10 \text{ mA}$ , $V_{CC} = 5.0 \text{ V}$ , $R_L = 1 \text{ k}\Omega$ , $V_{TH} = 1.5 \text{ V}$	$t_{on}$		4.3		$\mu\text{s}$
Rise time	$I_F = \pm 10 \text{ mA}$ , $V_{CC} = 5.0 \text{ V}$ , $R_L = 1 \text{ k}\Omega$ , $V_{TH} = 1.5 \text{ V}$	$t_r$		2.8		$\mu\text{s}$
Off time	$I_F = \pm 10 \text{ mA}$ , $V_{CC} = 5.0 \text{ V}$ , $R_L = 1 \text{ k}\Omega$ , $V_{TH} = 1.5 \text{ V}$	$t_{off}$		2.5		$\mu\text{s}$
Fall time	$I_F = \pm 10 \text{ mA}$ , $V_{CC} = 5.0 \text{ V}$ , $R_L = 1 \text{ k}\Omega$ , $V_{TH} = 1.5 \text{ V}$	$t_f$		11		$\mu\text{s}$
Propagation H to L	$I_F = \pm 10 \text{ mA}$ , $V_{CC} = 5.0 \text{ V}$ , $R_L = 1 \text{ k}\Omega$ , $V_{TH} = 1.5 \text{ V}$	$t_{PHL}$		2.6		$\mu\text{s}$
Propagation L to H	$I_F = \pm 10 \text{ mA}$ , $V_{CC} = 5.0 \text{ V}$ , $R_L = 1 \text{ k}\Omega$ , $V_{TH} = 1.5 \text{ V}$	$t_{PLH}$		7.2		$\mu\text{s}$

COMMON MODE TRANSIENT IMMUNITY						
PARAMETER	TEST CONDITION	SYMBOL	MIN.	TYP.	MAX.	UNIT
Common mode rejection, output high	$V_{CM} = 50 \text{ V}_{P-P}$ , $R_L = 1.0 \text{ k}\Omega$ , $I_F = 0 \text{ mA}$	$CM_H$		5000		$\text{V}/\mu\text{s}$
Common mode rejection, output low	$V_{CM} = 50 \text{ V}_{P-P}$ , $R_L = 1.0 \text{ k}\Omega$ , $I_F = 10 \text{ mA}$	$CM_L$		5000		$\text{V}/\mu\text{s}$

### TYPICAL CHARACTERISTICS

$T_{amb} = 25 \text{ }^\circ\text{C}$ , unless otherwise specified

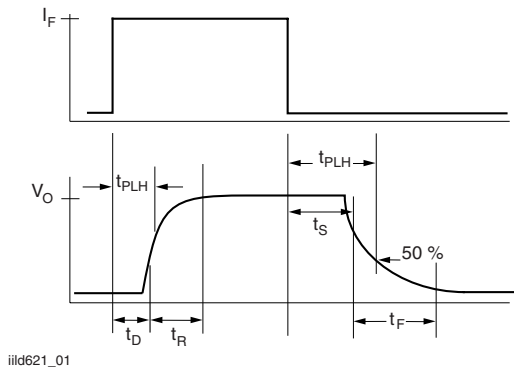

Fig. 1 - Non-Saturated Switching Timing

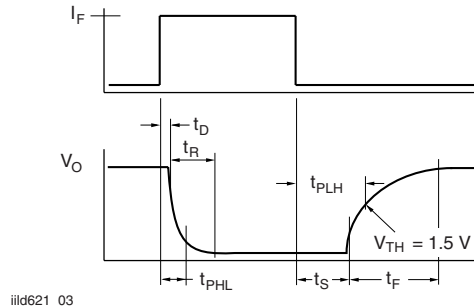

Fig. 3 - Saturated Switching Timing

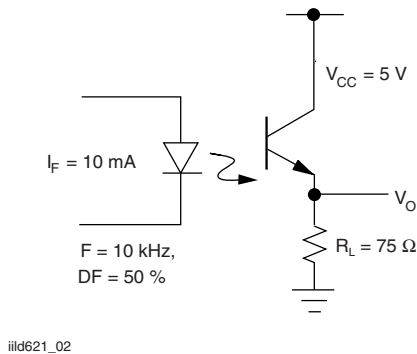

Fig. 2 - Non-Saturated Switching Timing

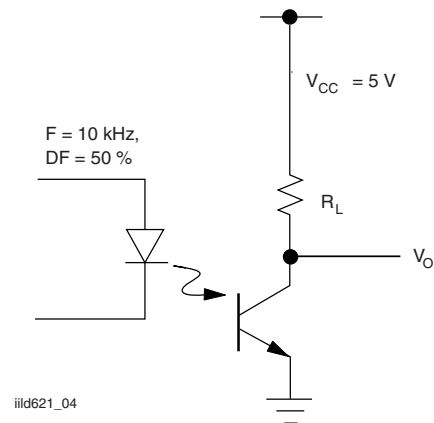

Fig. 4 - Saturated Switching Timing



# ILD621/ILD621GB/ILQ621/ILQ621GB

Optocoupler, Phototransistor Output  
(Dual, Quad Channel)

Vishay Semiconductors

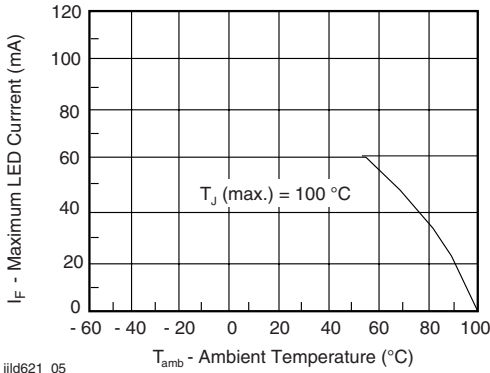

Fig. 5 - Maximum LED Current vs. Ambient Temperature

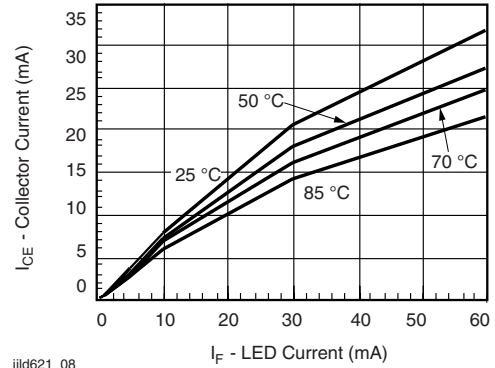

Fig. 8 - Collector Emitter Current vs. Temperature and LED Current

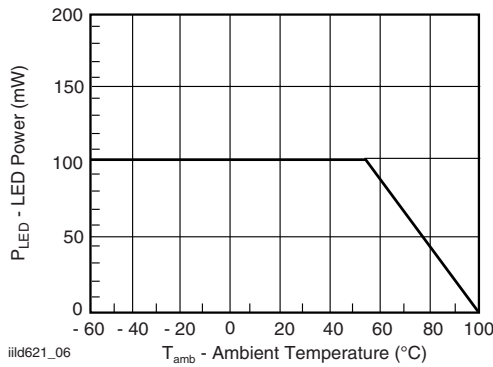

Fig. 6 - Maximum LED Power Dissipation

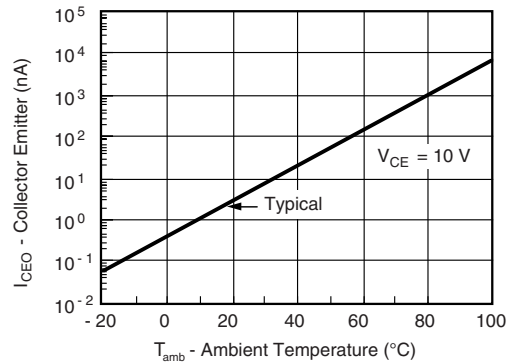

Fig. 9 - Collector Emitter Leakage vs. Temperature

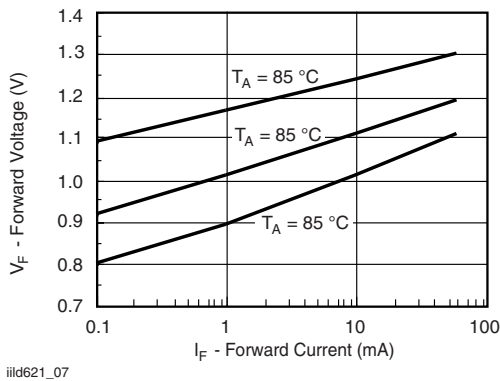

Fig. 7 - Forward Voltage vs. Forward Current

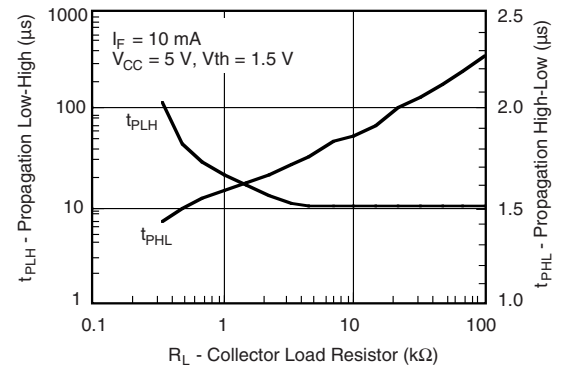

Fig. 10 - Propagation Delay vs. Collector Load Resistor

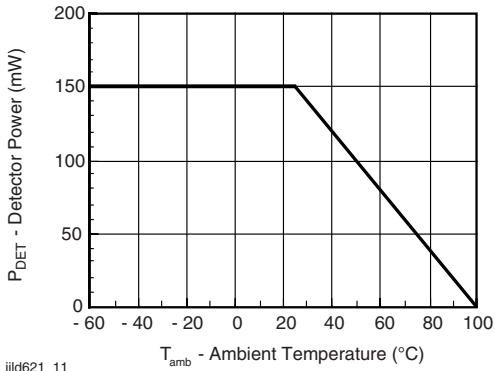

Fig. 11 - Maximum Detector Power Dissipation

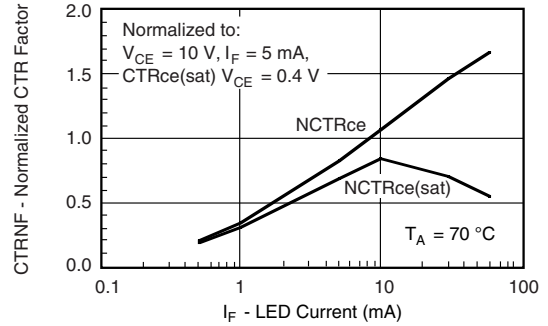

Fig. 14 - Normalization Factor for Non-Saturated and Saturated CTR vs.  $I_F$

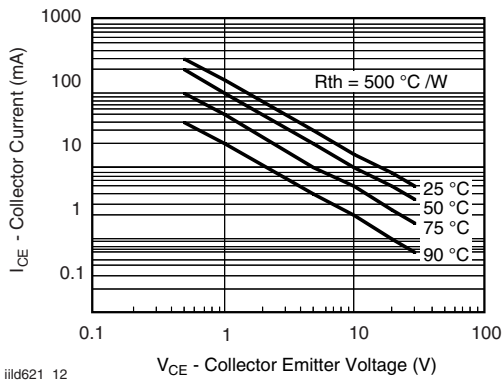

Fig. 12 - Maximum Collector Current vs. Collector Voltage

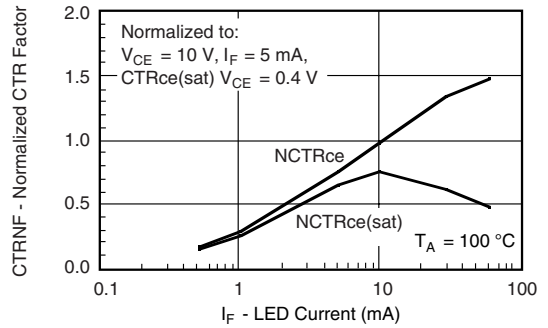

Fig. 15 - Normalization Factor for Non-Saturated and Saturated CTR vs.  $I_F$

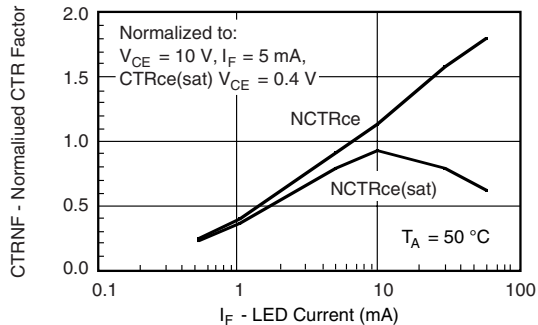

Fig. 13 - Normalization Factor for Non-Saturated and Saturated CTR vs.  $I_F$



# ILD621/ILD621GB/ILQ621/ILQ621GB

Optocoupler, Phototransistor Output  
(Dual, Quad Channel)

Vishay Semiconductors

## PACKAGE DIMENSIONS in inches (millimeters)

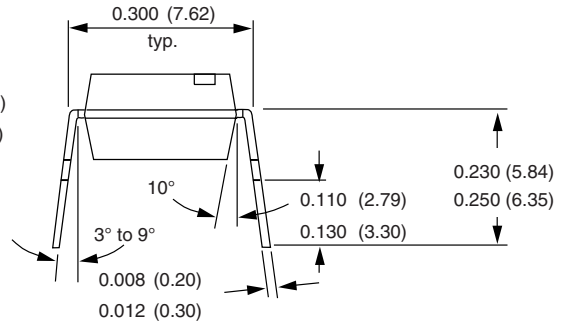
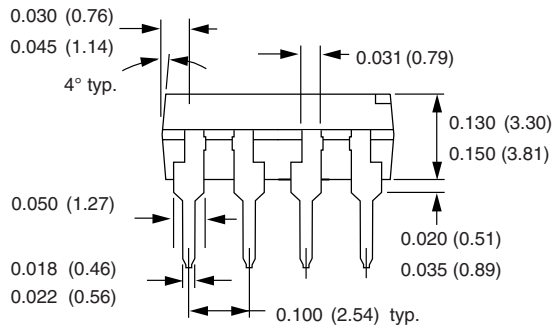
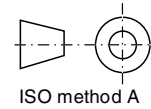
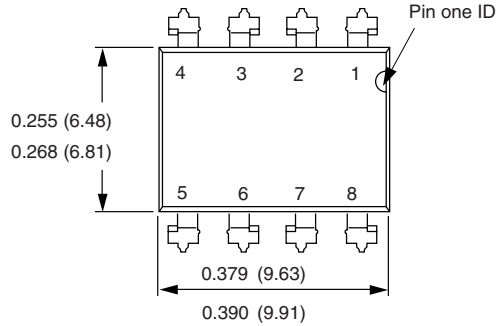

i178006

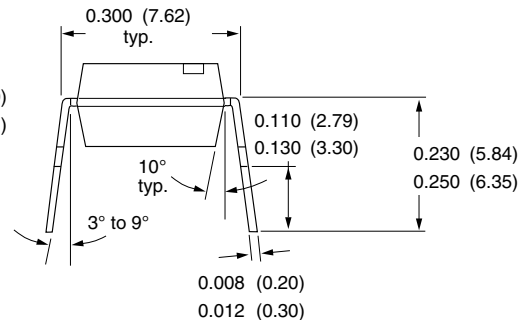
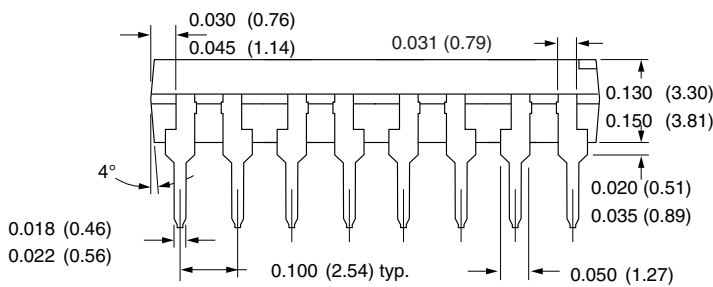
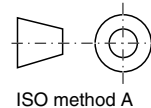
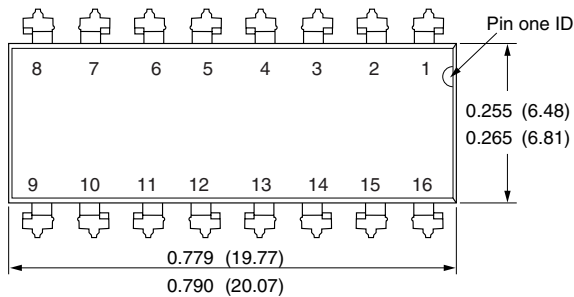

i178007

# ILD621/ILD621GB/ILQ621/ILQ621GB



Vishay Semiconductors

Optocoupler, Phototransistor Output  
(Dual, Quad Channel)

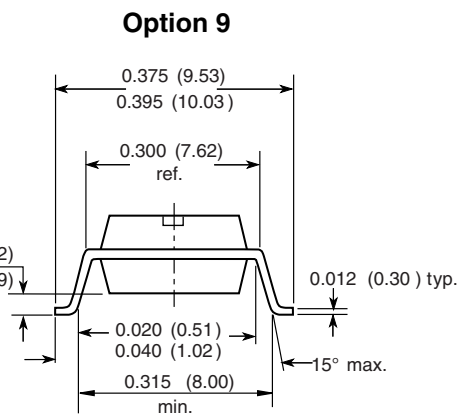
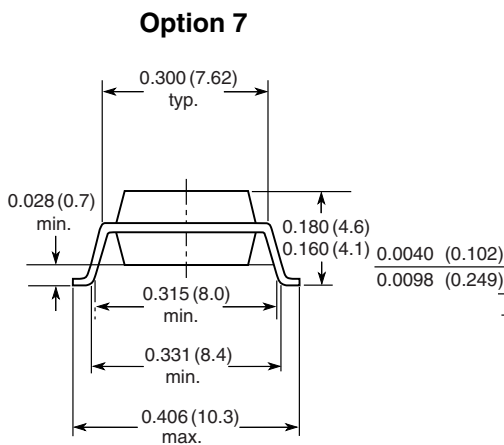
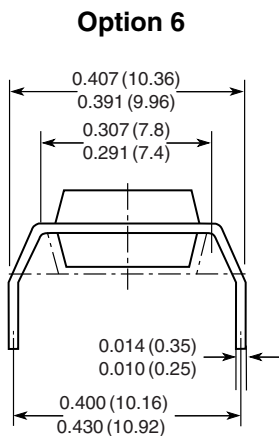

18450



**OZONE DEPLETING SUBSTANCES POLICY STATEMENT**

It is the policy of Vishay Semiconductor GmbH to

1. Meet all present and future national and international statutory requirements.
2. Regularly and continuously improve the performance of our products, processes, distribution and operating systems with respect to their impact on the health and safety of our employees and the public, as well as their impact on the environment.

It is particular concern to control or eliminate releases of those substances into the atmosphere which are known as ozone depleting substances (ODSs).

The Montreal Protocol (1987) and its London Amendments (1990) intend to severely restrict the use of ODSs and forbid their use within the next ten years. Various national and international initiatives are pressing for an earlier ban on these substances.

Vishay Semiconductor GmbH has been able to use its policy of continuous improvements to eliminate the use of ODSs listed in the following documents.

1. Annex A, B and list of transitional substances of the Montreal Protocol and the London Amendments respectively.
2. Class I and II ozone depleting substances in the Clean Air Act Amendments of 1990 by the Environmental Protection Agency (EPA) in the USA.
3. Council Decision 88/540/EEC and 91/690/EEC Annex A, B and C (transitional substances) respectively.

Vishay Semiconductor GmbH can certify that our semiconductors are not manufactured with ozone depleting substances and do not contain such substances.

We reserve the right to make changes to improve technical design  
and may do so without further notice.

Parameters can vary in different applications. All operating parameters must be validated for each customer application by the customer. Should the buyer use Vishay Semiconductors products for any unintended or unauthorized application, the buyer shall indemnify Vishay Semiconductors against all claims, costs, damages, and expenses, arising out of, directly or indirectly, any claim of personal damage, injury or death associated with such unintended or unauthorized use.

Vishay Semiconductor GmbH, P.O.B. 3535, D-74025 Heilbronn, Germany



## Disclaimer

All product specifications and data are subject to change without notice.

Vishay Intertechnology, Inc., its affiliates, agents, and employees, and all persons acting on its or their behalf (collectively, "Vishay"), disclaim any and all liability for any errors, inaccuracies or incompleteness contained herein or in any other disclosure relating to any product.

Vishay disclaims any and all liability arising out of the use or application of any product described herein or of any information provided herein to the maximum extent permitted by law. The product specifications do not expand or otherwise modify Vishay's terms and conditions of purchase, including but not limited to the warranty expressed therein, which apply to these products.

No license, express or implied, by estoppel or otherwise, to any intellectual property rights is granted by this document or by any conduct of Vishay.

The products shown herein are not designed for use in medical, life-saving, or life-sustaining applications unless otherwise expressly indicated. Customers using or selling Vishay products not expressly indicated for use in such applications do so entirely at their own risk and agree to fully indemnify Vishay for any damages arising or resulting from such use or sale. Please contact authorized Vishay personnel to obtain written terms and conditions regarding products designed for such applications.

Product names and markings noted herein may be trademarks of their respective owners.



## **Disclaimer**

ALL PRODUCT, PRODUCT SPECIFICATIONS AND DATA ARE SUBJECT TO CHANGE WITHOUT NOTICE TO IMPROVE RELIABILITY, FUNCTION OR DESIGN OR OTHERWISE.

Vishay Intertechnology, Inc., its affiliates, agents, and employees, and all persons acting on its or their behalf (collectively, "Vishay"), disclaim any and all liability for any errors, inaccuracies or incompleteness contained in any datasheet or in any other disclosure relating to any product.

Vishay makes no warranty, representation or guarantee regarding the suitability of the products for any particular purpose or the continuing production of any product. To the maximum extent permitted by applicable law, Vishay disclaims (i) any and all liability arising out of the application or use of any product, (ii) any and all liability, including without limitation special, consequential or incidental damages, and (iii) any and all implied warranties, including warranties of fitness for particular purpose, non-infringement and merchantability.

Statements regarding the suitability of products for certain types of applications are based on Vishay's knowledge of typical requirements that are often placed on Vishay products in generic applications. Such statements are not binding statements about the suitability of products for a particular application. It is the customer's responsibility to validate that a particular product with the properties described in the product specification is suitable for use in a particular application. Parameters provided in datasheets and / or specifications may vary in different applications and performance may vary over time. All operating parameters, including typical parameters, must be validated for each customer application by the customer's technical experts. Product specifications do not expand or otherwise modify Vishay's terms and conditions of purchase, including but not limited to the warranty expressed therein.

Except as expressly indicated in writing, Vishay products are not designed for use in medical, life-saving, or life-sustaining applications or for any other application in which the failure of the Vishay product could result in personal injury or death. Customers using or selling Vishay products not expressly indicated for use in such applications do so at their own risk. Please contact authorized Vishay personnel to obtain written terms and conditions regarding products designed for such applications.

No license, express or implied, by estoppel or otherwise, to any intellectual property rights is granted by this document or by any conduct of Vishay. Product names and markings noted herein may be trademarks of their respective owners.

## X-ON Electronics

Largest Supplier of Electrical and Electronic Components

*Click to view similar products for [Transistor Output Optocouplers](#) category:*

*Click to view products by [Vishay](#) manufacturer:*

Other Similar products are found below :

[LTV-814S-TA](#) [LTV-824HS](#) [LTV-852S](#) [66095-001](#) [6N136-X017T](#) [MCT6-X007](#) [MOC8101-X017T](#) [PS2561-1-A](#) [PS2561A-1-W-A](#)  
[PS2561B-1-L-A](#) [PS2561L-1-V-A](#) [MRF658](#) [IL755-1X007](#) [ILD74-X001](#) [ILQ615-2X017](#) [ILQ615-3X016](#) [LDA102S](#) [LDA110S](#) [PS2561-1-V-](#)  
[W-A](#) [PS2561AL-1-V-A](#) [PS2561L1-1-L-A](#) [PS2701A-1-F3-P-A](#) [PS2801-1-F3-P-A](#) [PS2911-1-L-AX](#) [CNY17-2X017](#) [CNY17-4X001](#) [CNY17-](#)  
[4X017](#) [CNY17F-1X007](#) [CNY17F-2X017](#) [CNY17F-4X001](#) [CNY17G-1](#) [LTV-214](#) [LTV-702VB](#) [LTV-733S](#) [LTV-816S-TA](#) [LTV-825S](#)  
[TCET1113](#) [TCET2100](#) [4N25-X007T](#) [IL215AT](#) [ILQ2-X007](#) [VOS615A-2T](#) [WPPC-A11066AA](#) [WPPC-A11066AD](#) [WPPC-A11084ASS](#)  
[WPPC-A21068AA](#) [WPPC-D11066AA](#) [WPPC-D21068ED](#) [WPPC-D410616EA](#) [WPPC-D410616ED](#)