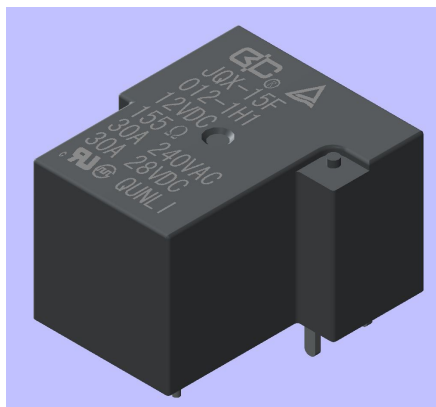

JQX-15F**小型大功率通用继电器****MINIATURE HIGH POWER GENERAL RELAY****特 性 Features**

- ◆最大 40A 触点切换能力
Max 40A switching capability
- ◆触点形式：一组动合、一组转换
Contact arrangement: 1 Form A、1 Form C
- ◆标准印制板引出脚
Standard PCB layout
- ◆塑封型
Plastic sealed
- ◆环保产品（符合 RoHS）
Environmental friendly product (RoHS compliant)

触点参数 CONTACT DATA

触点形式 Contact Form	1H	1D	1Z
接触电阻 Contact Resistance	100mΩ (1A 6VDC)		
触点材料 Contact Material	银合金 Silver alloy		
触点负载（阻性） Contact Rating (Resistive load)	30A 28VDC/20A 240VAC 40A 28VDC/40A 220VAC (40A 只针对 1H6 规格)	15A 28VDC 15A 240VAC	NO:20A 28VDC 20A 240VAC NC:10A 28VDC 10A 240VAC
最大切换电压 Max Switching Voltage	30VDC 300VAC		
最大切换电流 Max Switching Current	30A/40A	20A	NO:20A NC:10A
最大切换功率 Max Switching Power	900W/ 9000VA (30A) 1200W /12000VA (40A)	600W/6000VA	NO:600W/6000VA NC:300W/3000VA

陕西群力电工有限责任公司**Shaanxi Qunli Electric Co., Ltd.**

地址：陕西省宝鸡市陈仓区群力路 1 号

ADDRESS: NO.1, QUNLI ROAD, BAOJI, SHAANXI Prov.

邮政编码：721300

POSTAL CODE: 721300

电话/传真：0917-6293906/6293729

TAX/ FAX: 0917-6293906/6293729

机械耐久性 Mechanical Life Expectancy		1×10 ⁶ ops
电耐久性 Electrical Life Expectancy		40A:1×10 ⁴ ops; 其余 1×10 ⁵ ops

性能参数 CHARACTERISTICS DATA

绝缘电阻 Insulation resistance		1000MΩ (500VDC)
介质耐压 Dielectric withstanding Voltage	线圈与触点间 Between coil & contacts	引出端形式为 1:1500VAC 1min 引出端形式为 6:2500VAC 1min 引出端形式为 7:1500VAC 1min
	断开触点间 Between open contacts	1500VAC 1min
动作时间 (额定电压下) Operate time (at nomi. volt.)		≤15ms
释放时间 (额定电压下) Release time (at nomi. volt.)		≤10ms
冲击 Shock resistance	稳定性 Functional	98m/s ²
	强度 Destructive	980m/s ²
振动 Vibration resistance		10~55Hz, 1.65mm 双振幅 10~55Hz, 1.65mm DA
相对湿度 Relative Humidity		At 40°C, to 98%
温度范围 Temperature Range		-55°C~85°C
引出端方式 Termination		印制电路板式 PCB
重量 Weight		≤34g
封装方式 Construction		塑封型 Plastic sealed

备注: 对于塑封型产品试验时, 应打开外壳上的透气孔。

Notes: For sealed type, the vent-hole cover should be excised.

线圈 COIL

陕西群力电工有限责任公司

Shaanxi Qunli Electric Co., Ltd.

地址: 陕西省宝鸡市陈仓区群力路 1 号

ADDRESS: NO.1, QUNLI ROAD, BAOJI, SHAANXI Prov.

邮政编码: 721300

POSTAL CODE: 721300

电话/传真: 0917-6293906/6293729

TAX/ FAX: 0917-6293906/6293729

线圈功率 Coil power	0.9W
--------------------	------

线圈参数 COIL DATA 20℃

额定电压(VDC) Nominal Voltage (VDC)	动作电压(VDC) Operate Voltage(VDC)	释放电压(VDC) Release Voltage(VDC)	线圈电阻(Ω) Coil Resistance(Ω)
5	3.75	0.5	27 × (1±10%)
6	4.5	0.6	40 × (1±10%)
9	6.75	0.9	97 × (1±10%)
12	9.0	1.2	155 × (1±10%)
15	11.25	1.5	256 × (1±10%)
18	13.5	1.8	380 × (1±10%)
24	18	2.4	660 × (1±10%)
48	36	4.8	2560 × (1±10%)
110	82.5	11	13450 × (1±10%)

安全认证 SAFETY APPROVAL RATINGS

UL	TUV	CQC
----	-----	-----

陕西群力电工有限责任公司

Shaanxi Qunli Electric Co., Ltd.

地址：陕西省宝鸡市陈仓区群力路1号

ADDRESS: NO.1, QUNLI ROAD, BAOJI, SHAANXI Prov.

邮政编码：721300

POSTAL CODE: 721300

电话/传真：0917-6293906/6293729

TAX/ FAX: 0917-6293906/6293729

订货示例 ORDERING INFORMATION

JQX-15F / 024 - 1H 64 - 40A

40A: 触点负载为, 只针对 1H6 规格

40A : The contact load only for 1H6 40A specifications

引出端形式 1: 触点负荷输出端与线圈输入端位于同侧

Termination: 1: The contact load and the output end of the coil input end is positioned at the same side.

6: 触点负荷输出端与线圈输入端位于两侧

6: The contact load and the output end of the coil input end is located on the both sides of the coil.

64: 低高度 (触点负荷输出端同 6)

64 : Low height (The contact load output terminal with 6)

7: 触点负荷输出端与线圈输入端位于同侧, 线圈输入端为插片式

7: The contact load and the output end of the coil input end is positioned at the same side, coil input end is inserted type.

触点形式: 1H: 一组动合; 1D: 1 组动断; 1Z: 一组转换

Contact arrangement: 1H: 1 Form A; 1D:

1 Form B; 1Z: 1 Form C

线圈电压

Coil voltage

产品型号

Relay Type

陕西群力电工有限责任公司

Shaanxi Qunli Electric Co., Ltd.

地址: 陕西省宝鸡市陈仓区群力路 1 号

ADDRESS: NO.1, QUNLI ROAD, BAOJI, SHAANXI Prov.

邮政编码: 721300

POSTAL CODE: 721300

电话/传真: 0917-6293906/6293729

TAX/ FAX: 0917-6293906/6293729

外形图、接线图 OUTLINE DIMENSIONS, WIRING DIAGRAM

JQX-15F/XXX-1Z64

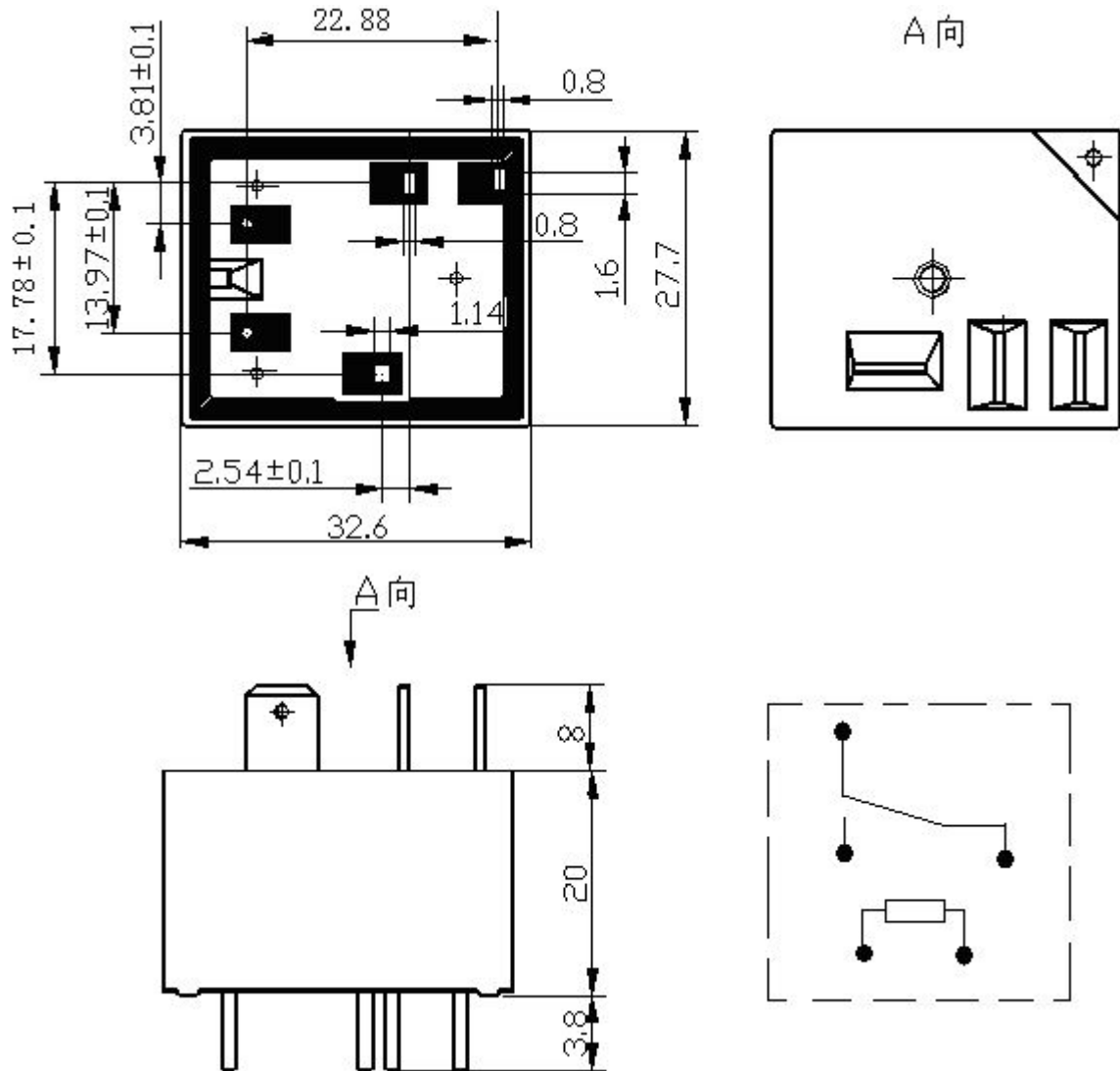

外形图

Outline Dimensions

接线图 (底视图)

Wiring Diagram (Bottom)

陕西群力电工有限责任公司

Shaanxi Qunli Electric Co., Ltd.

地址: 陕西省宝鸡市陈仓区群力路 1 号

ADDRESS: NO.1, QUNLI ROAD, BAOJI, SHAANXI Prov.

邮政编码: 721300

POSTAL CODE: 721300

电话/传真: 0917-6293906/6293729

TAX/ FAX: 0917-6293906/6293729

JQX-15F/XXX-1H6 (40A)

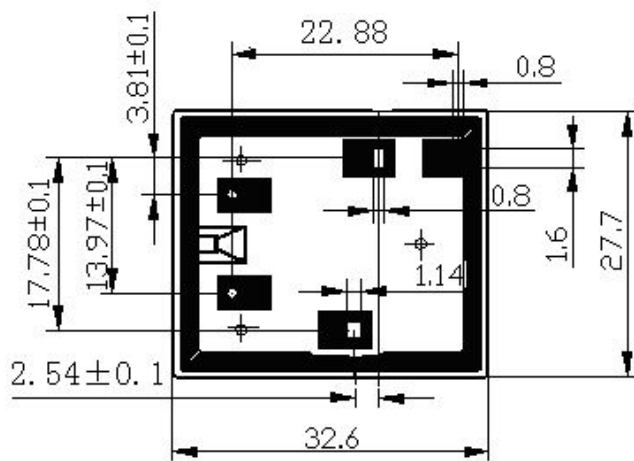

A向

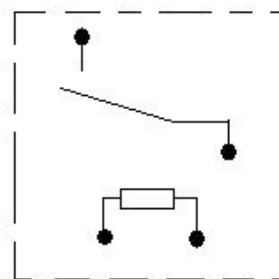
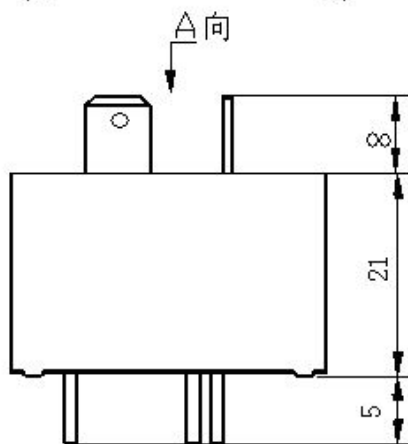
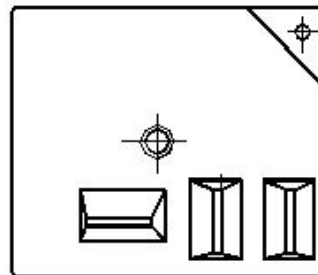

外形图

Outline Dimensions

接线图 (底视图)

Wiring Diagram (Bottom)

JQX-15F/XXX-1Z1

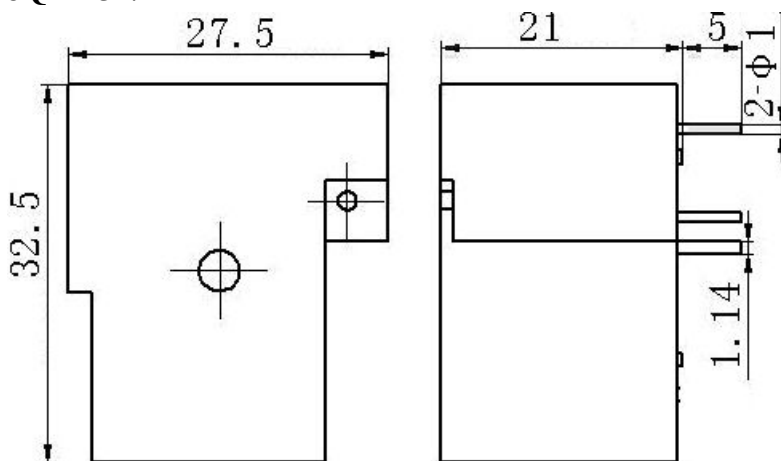

外形图

Outline Dimensions

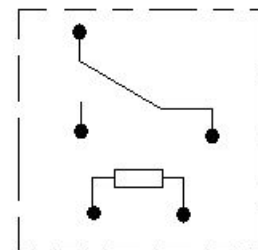

接线图 (底视图)

Wiring Diagram (Bottom)

陕西群力电工有限责任公司

Shaanxi Qunli Electric Co., Ltd.

地址: 陕西省宝鸡市陈仓区群力路1号

ADDRESS: NO.1, QUNLI ROAD, BAOJI, SHAANXI Prov.

邮政编码: 721300

POSTAL CODE: 721300

电话/传真: 0917-6293906/6293729

TAX/ FAX: 0917-6293906/6293729

JQX-15F/XXX-1Z7

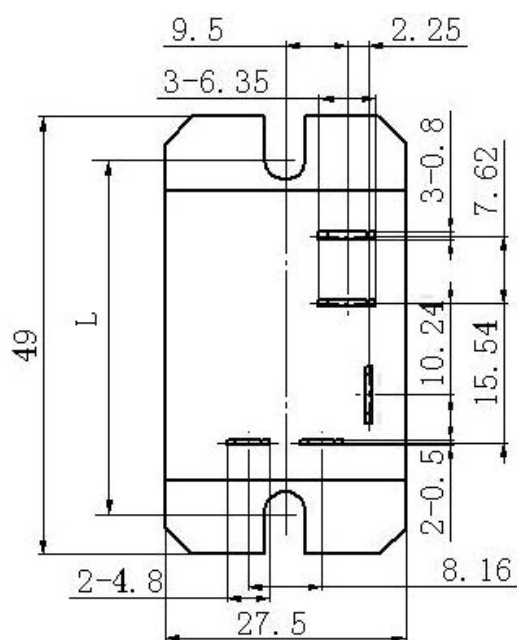

L=39.5±0.1 或 43.5±0.1

外形图

Outline Dimensions

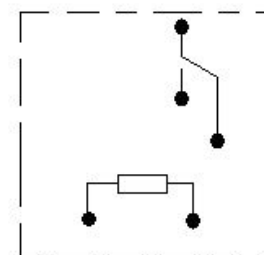
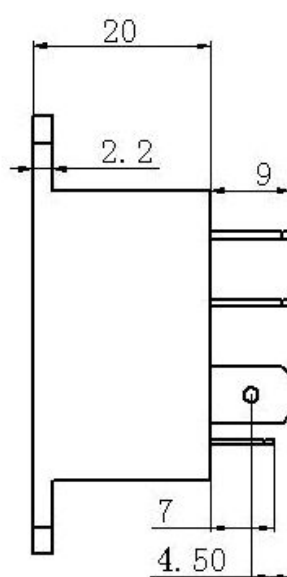

接线图 (底视图)

Wiring Diagram (Bottom)

- 备注: (1) 产品部分外形尺寸未注尺寸公差, 当外形尺寸 $\leq 1\text{mm}$, 公差为 $\pm 0.2\text{mm}$; 当外形尺寸在 $(1\sim 5)\text{mm}$ 之间时, 公差为 $\pm 0.3\text{mm}$; 当外形尺寸 $> 5\text{mm}$, 公差为 $\pm 0.5\text{mm}$;
 (2) 安装孔尺寸中未注尺寸公差为 $\pm 0.1\text{mm}$ 。

- Notes: (1) In case of no tolerance shown in outline dimension; outline dimension $\leq 1\text{mm}$, tolerance should be $\pm 0.2\text{mm}$; outline dimension between 1mm and 5mm , tolerance should be $\pm 0.3\text{mm}$; outline dimension $> 5\text{mm}$, tolerance should be $\pm 0.5\text{mm}$.
 (2) The tolerance without indicating for PCB layout is always $\pm 0.1\text{mm}$.

陕西群力电工有限责任公司

Shaanxi Qunli Electric Co., Ltd.

地址: 陕西省宝鸡市陈仓区群力路1号

ADDRESS: NO.1, QUNLI ROAD, BAOJI, SHAANXI Prov.

邮政编码: 721300

POSTAL CODE: 721300

电话/传真: 0917-6293906/6293729

TAX/ FAX: 0917-6293906/6293729

X-ON Electronics

Largest Supplier of Electrical and Electronic Components

Click to view similar products for [General Purpose Relays](#) category:

Click to view products by [Vishay](#) manufacturer:

Other Similar products are found below :

[PCN-105D3MH,000](#) [59641F200](#) [5JO-1000CD-SIL](#) [5X827E](#) [5X837F](#) [5X840F](#) [5X842F](#) [5X848E](#) [LY2N-AC120](#) [LY2-US-AC120](#) [M115C60](#)
[M115N010](#) [M115N0150](#) [603-12D](#) [60HE1-5DC](#) [60HE2S-12DC](#) [61211T0B4](#) [61212T400](#) [61222Q400](#) [61243B600](#) [61243C500](#) [61243Q400](#)
[61311BOA2](#) [61311BOA6](#) [61311BOA8](#) [61311C0A2](#) [61311COA1](#) [61311COA6](#) [61311F0A2](#) [61311QOA1](#) [61311QOA4](#) [61311T0D6](#)
[61311TOA6](#) [61311TOA7](#) [61311TOB3](#) [61311TOB4](#) [61311U0A6](#) [61312Q600](#) [61312T400](#) [61312T600](#) [61313U200](#) [61313U400](#) [61322T400](#)
[61332C400](#) [61343C200](#) [61343C600](#) [61343Q200](#) [61343T100](#) [61343T200](#) [61343T400](#)