

## QPL MIL-PRF-55342 Qualified Thin Film Resistor, Surface Mount Chip

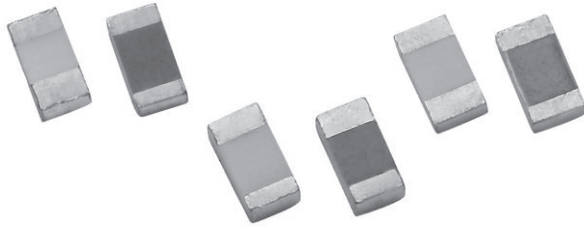

Thin Film Mil chip resistors feature all sputtered wraparound termination for excellent adhesion and dimensional uniformity. They are ideal in applications requiring stringent performance requirements. Established reliability is assured through 100 % screening and extensive environmental lot testing.

### CONSTRUCTION

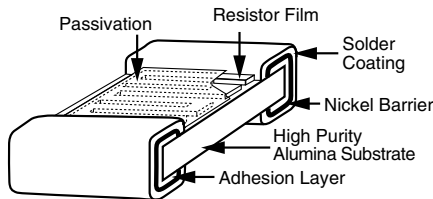

### FEATURES

- Established reliability, “S” and “V” failure rate level (10 ppm), C = 2
- High purity alumina substrate
- Wraparound termination featuring a tenacious adhesion layer covered with an electroplated nickel barrier layer for +150 °C operating conditions
- Very low noise and voltage coefficient (< -25 dB, 0.5 ppm/V)
- Non-inductive
- Laser-trimmed tolerances ± 0.1 %
- Wraparound resistance less than 0.010 Ω typical
- In-lot tracking less than 5 ppm/°C
- Complete MIL-testing available in-house
- Antistatic waffle pack or tape and reel packaging available
- Military / aerospace / QPL

### TYPICAL PERFORMANCE

	ABSOLUTE
TCR	25
TOL.	0.1

### STANDARD ELECTRICAL SPECIFICATIONS

TEST	SPECIFICATIONS	CONDITIONS
Material	Tamelox resistor film (passivated nichrome)	-
Resistance Range	10 Ω to 6.19 MΩ	-
TCR: Absolute	± 25 ppm/°C to ± 300 ppm/°C	-55 °C to +125 °C
Tolerance: Absolute	± 0.1 % to ± 10 %	+25 °C
Stability: Absolute	ΔR ± 0.02 %	2000 h at +70 °C
Stability: Ratio	-	-
Voltage Coefficient	0.1 ppm/V	-
Working Voltage	30 V to 200 V	-
Operating Temperature Range	-55 °C to +150 °C	-
Storage Temperature Range	-55 °C to +150 °C	-
Noise	< - 25 dB	-
Shelf Life Stability: Absolute	ΔR ± 0.01 %	1 year at +25 °C

### COMPONENT RATINGS

CASE SIZE	POWER RATING (mW)	WORKING VOLTAGE (V)	RESISTANCE RANGE (Ω) BY CHARACTERISTICS TOLERANCE			
			E (0.1 %, 0.25 %, 0.5 %)	E (1 %, 2 %, 5 %)	H, K, L, M (0.1 %, 0.25 %, 0.5 %)	H, K, L, M (1 %, 2 %, 5 %)
M55342/01	50	40	49.9 to 150K	49.9 to 150K	20 to 150K	20 to 150K
M55342/02	125	40	49.9 to 301K	49.9 to 301K	20 to 301K	20 to 301K
M55342/03	200	75	49.9 to 649K	49.9 to 649K	10 to 649K	10 to 649K
M55342/04	150	125	49.9 to 1.69M	49.9 to 1.69M	10 to 1.69M	10 to 1.69M
M55342/05	225	175	49.9 to 3.16M	49.9 to 3.16M	10 to 3.16M	10 to 3.16M
M55342/06	150	50	49.9 to 475K	49.9 to 475K	10 to 475K	10 to 475K
D55342/07	250	100	49.9 to 1.5M	49.9 to 1.5M	10 to 1.5M	10 to 1.5M
M55342/08	800	150	49.9 to 4.02M	49.9 to 4.02M	10 to 4.02M	10 to 4.02M
M55342/09	1000	200	49.9 to 6.19M	49.9 to 6.19M	10 to 6.19M	10 to 6.19M
M55342/10	500	75	49.9 to 1M	49.9 to 1M	49.9 to 1M	49.9 to 1M
M55342/11	50	30	49.9 to 100K	49.9 to 100K	20 to 100K	20 to 100K
M55342/12	100	50	49.9 to 258K	49.9 to 261K	10 to 258K	10 to 261K

#### Note

- Values listed are a guide, refer to MIL spec for value/tolerance allowance



**DIMENSIONS** in inches

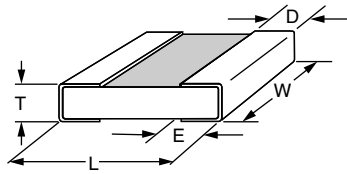

CASE SIZE	TERM.	L	W	T	D	E
M55342/01	B	0.055 ± 0.006	0.025 ± 0.005	0.010 to 0.033	0.010 ± 0.005	0.015 ± 0.005
M55342/02	B	0.055 ± 0.006	0.050 ± 0.005	0.010 to 0.033	0.010 ± 0.005	0.015 ± 0.005
M55342/03	B	0.105 ± 0.007	0.050 ± 0.005	0.010 to 0.033	0.015 ± 0.005	0.015 ± 0.005
M55342/04	B	0.155 ± 0.007	0.050 ± 0.005	0.015 to 0.033	0.015 ± 0.005	0.015 ± 0.005
M55342/05	B	0.230 ± 0.007	0.075 ± 0.005	0.010 to 0.033	0.020 ± 0.005	0.020 ± 0.005
M55342/06	B	0.080 ± 0.006	0.050 ± 0.005	0.010 to 0.033	0.016 ± 0.008	0.015 ± 0.005
D55342/07	B	0.126 ± 0.008	0.063 ± 0.005	0.010 to 0.033	0.020 + 0.005/- 0.010	0.020 + 0.005/- 0.010
M55342/08	B	0.209 + 0.009/- 0.018	0.098 ± 0.005	0.010 to 0.033	0.020 ± 0.005	0.020 ± 0.005
M55342/09	B	0.259 + 0.009/- 0.015	0.124 ± 0.005	0.010 to 0.033	0.020 ± 0.005	0.020 ± 0.005
M55342/10	B	0.105 ± 0.007	0.100 ± 0.005	0.010 to 0.033	0.015 ± 0.005	0.015 ± 0.005
M55342/11	B	0.040 ± 0.005	0.025 ± 0.005	0.010 to 0.033	0.010 ± 0.005	0.015 ± 0.005
M55342/12	B	0.064 ± 0.006	0.032 ± 0.005	0.010 to 0.033	0.012 ± 0.005	0.015 ± 0.005

**ENVIRONMENTAL TESTS**

ENVIRONMENTAL TEST	MIL-PRF-55342 LIMITS (ΔR ±)	VISHAY PERFORMANCE (ΔR ±)
Thermal Shock	0.1 %	0.020 %
Low Temperature Operation	0.1 %	0.025 %
Short Time Overload	0.1 %	0.050 %
High Temperature Exposure	0.1 %	0.009 %
Resistance to Bonding	0.2 %	0.006 %
Moisture Resistance	0.2 %	0.004 %
TCR	± 25 ppm/°C	< 15 ppm/°C
Life (2000 h at + 70 °C)	0.5 %	0.02 %
Life (10 000 h at + 70 °C)	2.0 %	0.04 %

**MECHANICAL SPECIFICATIONS**

Resistive Element	Tamelox
Substrate Material	Alumina
Chip Terminations	Solder over nickel
Fused Solder	Plated solder 90/10

**FSCM CAGE # - 57489**

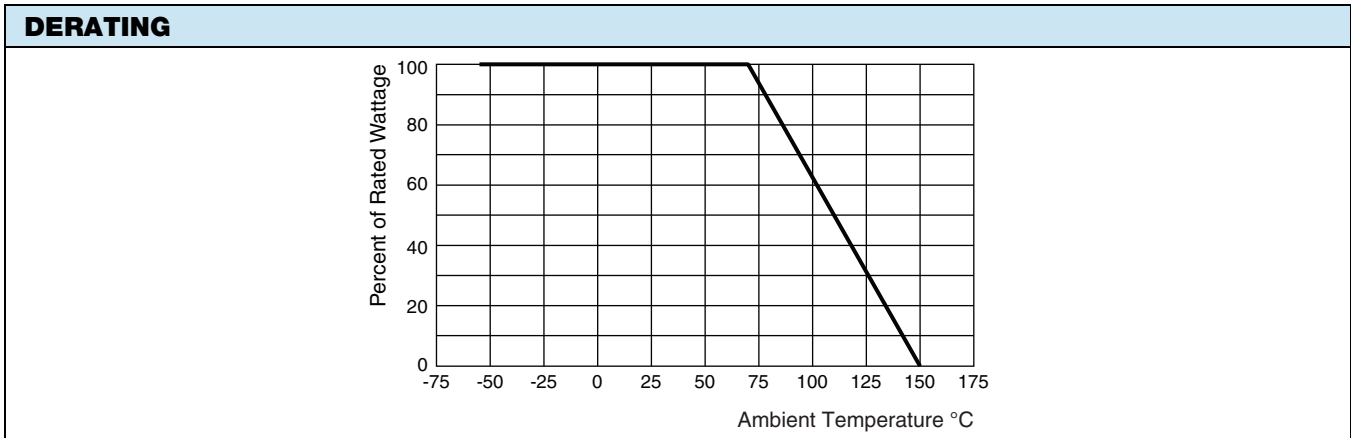

### GLOBAL PART NUMBER INFORMATION

New Global Part Numbering: **M55342E06B1C00RTS V**

GLOBAL MODEL	TCR CHARACTERISTIC	CASE SIZE	TERMINATION	OHMIC VALUE	FAILURE RATE	PACKAGING	THIN FILM CODE (1)
M55342 or D55342 (/07 size only)	E = 25 ppm/°C H = 50 ppm/°C K = 100 ppm/°C L = 200 ppm/°C M = 300 ppm/°C	01 = 0502 02 = 0505 03 = 1005 04 = 1505 05 = 2208 06 = 0705 07 = 1206 08 = 2010 09 = 2512 10 = 1010 11 = 0402 12 = 0603	B = Solderable	Three digits and a letter. Letter identifies tolerance, acts as multiplier and decimal locator.  MULTIPLIER Tolerance 1 Ω 1 kΩ 1 MΩ 0.1 % A B C 0.25 % R U V 0.5 % W Y Z 1 % D E F 2 % G H T 5 % J K L 10 % M N P	M = 1.0 % per 1000 h P = 0.1 % per 1000 h R = 0.01 % per 1000 h U = 0.01 % per 1000 h (3) S = 0.001 % per 1000 h V = 0.001 % per 1000 h (3) C = Non ER version	<b>Standard Packaging:</b> BS = BULK 100 min., 1 mult WS = WAFFLE 100 min., 1 mult WO = WAFFLE 100 min., 100 mult TAPE AND REEL TO = 100 min., 100 mult T1 = 1000 min., 1000 mult T3 = 300 min., 300 mult T5 = 500 min., 500 mult TF = Full reel ( 2K, 4K, or 5K dependent on case size ) per tape and reel document 60034 TS = 100 min., 1 mult <b>Special Packaging:</b> WAFFLE WI = 100 min., 1 mult (item single lot date code) WP = 100 min., 1 mult (package unit single lot date code) TAPE AND REEL TI = 100 min., 1 mult (item single lot date code) TP = 100 min., 1 mult (package unit single lot date code)	V for K, L and M TCR W/tolerance ≥ 1 % M = Part marked (2)

Historical Part Number example: **M55342K06B5E60R** (for reference purposes only)

M55342	K	06	B	5E60	R
SERIES	TCR CHARACTERISTIC	CASE SIZE	TERMINATION	VALUE AND TOLERANCE	FAILURE RATE

**Notes**

- (1) Only add a V at the end of part number to specify Vishay Dale Thin Film for K, L and M TCR and tolerance 1 % and higher.
- (2) Option 1 marking only. Case sizes 01, 02, 11, and 12 not available due to size.
- (3) Failure Rate U and V require Group A and B testing on a Production Lot Basis.



### Vishay Dale Thin Film Land Patterns

#### 1. Scope

This technical note provides sample land patterns for Vishay Dale Thin Film SMT resistive products. The following drawings are based on IPC-SM-782 Surface Mount Design and Land Pattern Standard. These drawings are for reference only Vishay Thin Film recommends that the user contacts their PC board supplier for actual land patterns required. The pads are intended for lead (Pb)-free and tin / lead solder types.

#### 2. Product Series

Thin Film Surface Mount Chip Resistors (FC, L, P, PTN, PLT, PLTT, PLTU, PAT, PATT, PNM, M/D55342 QPL Series)

**0402 Land Pattern**

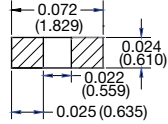

**0502 Land Pattern**

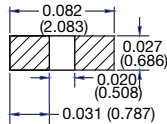

**0505 Land Pattern**

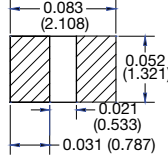

**0603 Land Pattern**

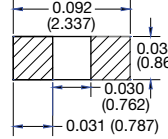

**0705 Land Pattern**

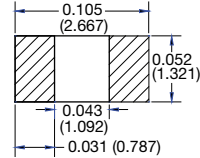

**1005 Land Pattern**

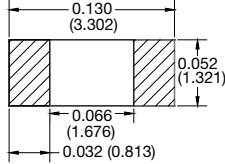

**1010 Land Pattern**

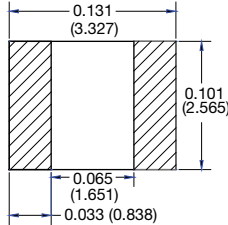

**1206 Land Pattern**

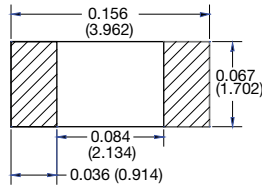

**1505 Land Pattern**

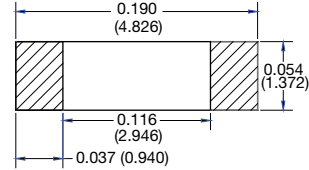

**2010 Land Pattern**

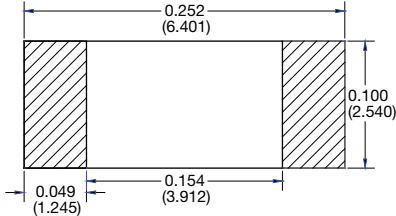

**2208 Land Pattern**

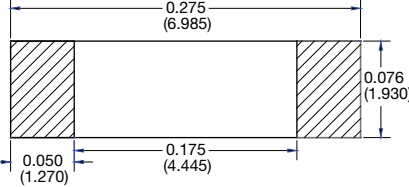

**2512 Land Pattern**

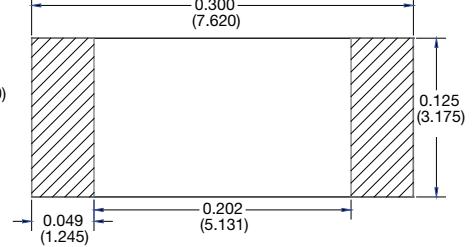



### Thin Film Surface Mount Chip Resistors (PHP, PCAN Series)

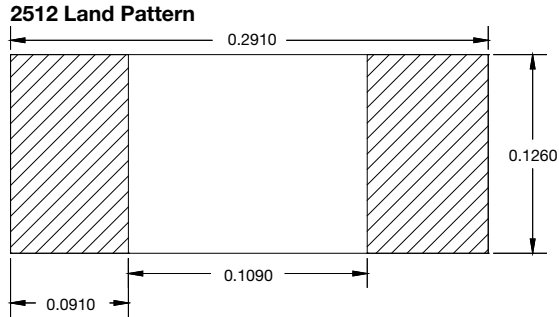
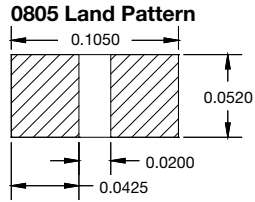
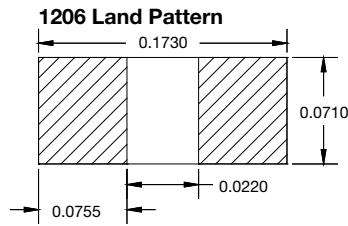
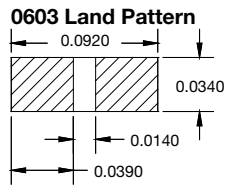

### Thin Film Surface Mount Chip Resistors Long Axis Termination (L Series)

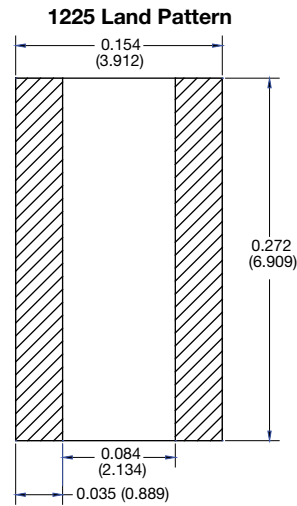
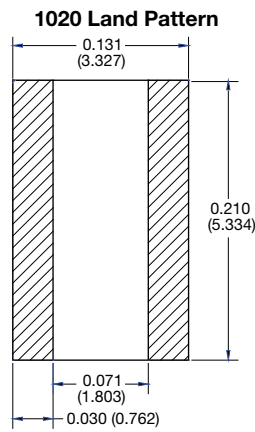
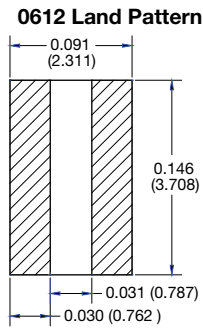
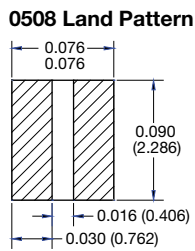



### Surface Mount Networks (MPM, MP3, MP4 Series)

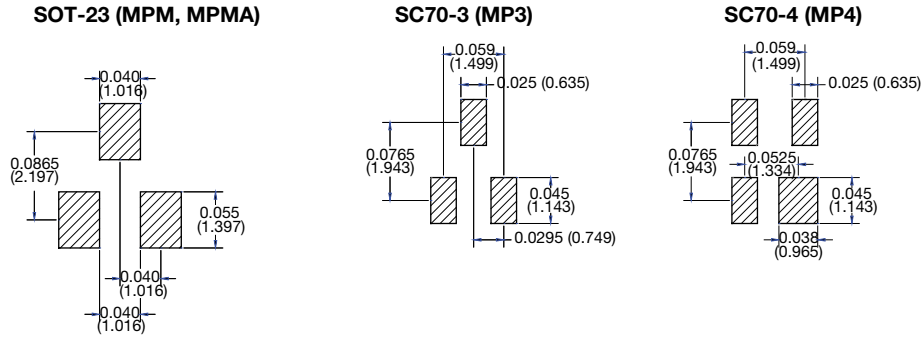

### Surface Mount Networks SOIC Narrow Body 150 mils (ORN, CSO, MOMC, HTRN, AORN, MORN Series)

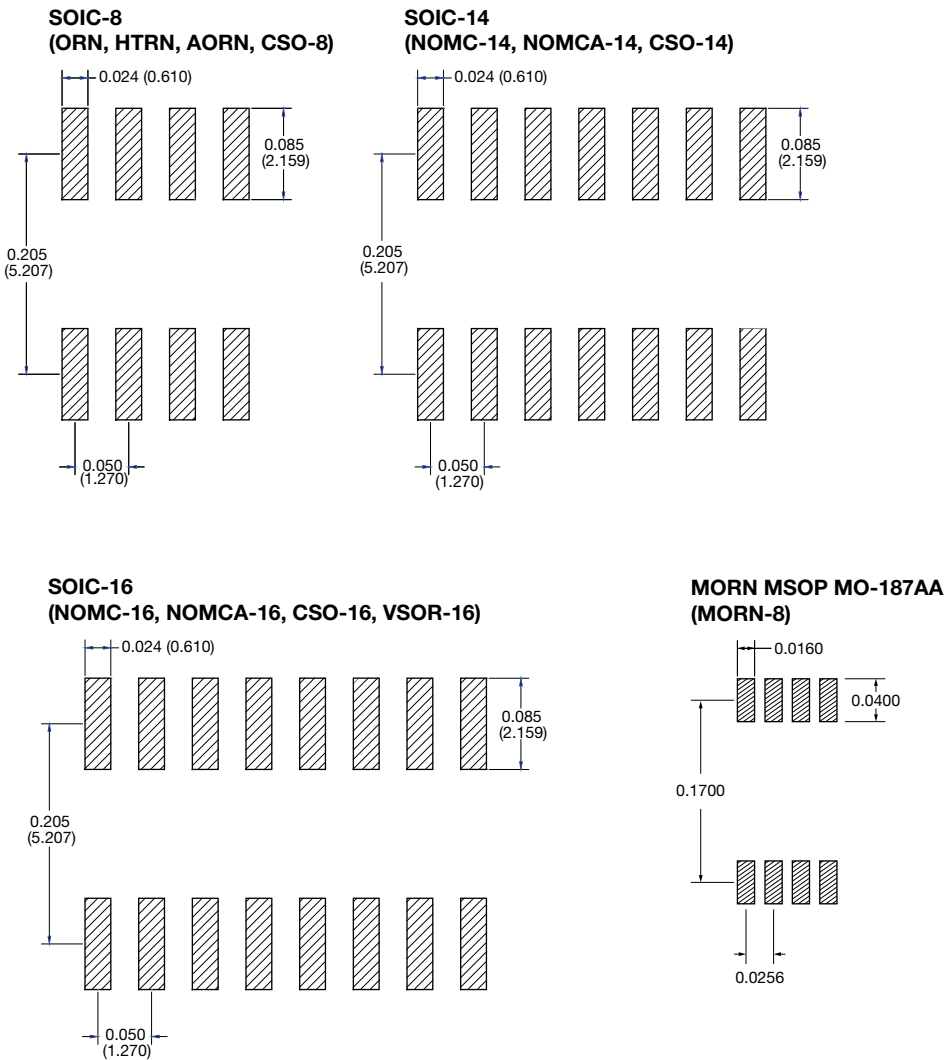



### Surface Mount Networks SOIC Medium Body 220 mils (TOMC Series)

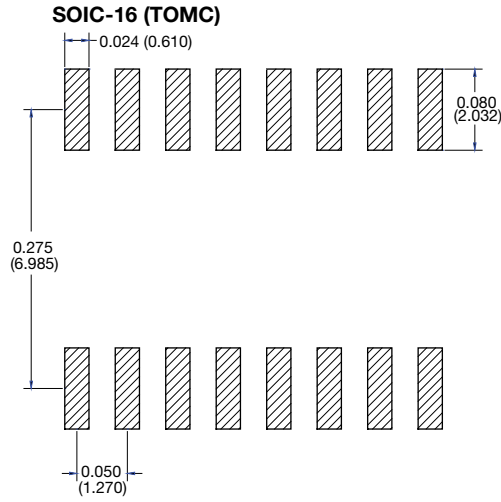

### Surface Mount Networks SOIC Wide Body 300 mils (WOMC Series)

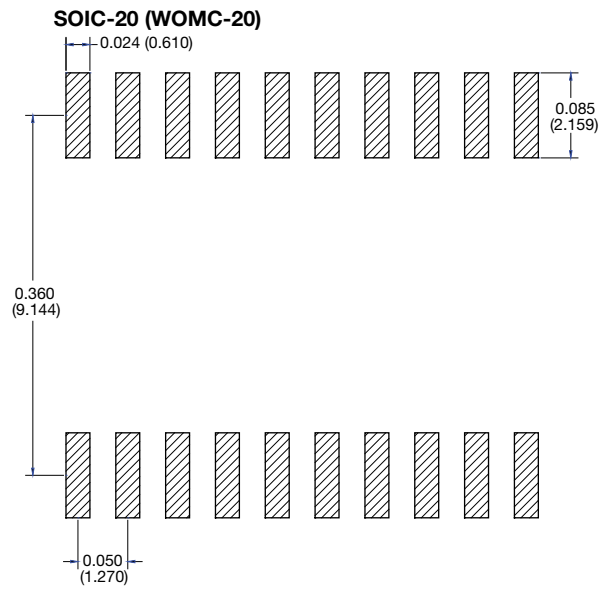
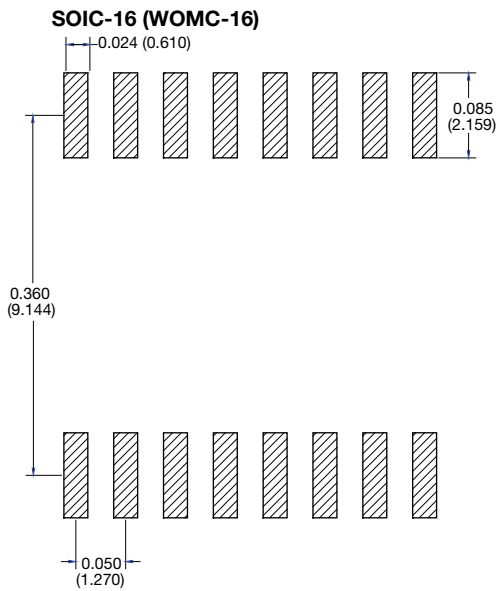



### Surface Mount Networks High Density SSOP, TSOP (VSSR, VTSR Series)

#### SSOP MO-137

##### OSOP-16, VSSR-16

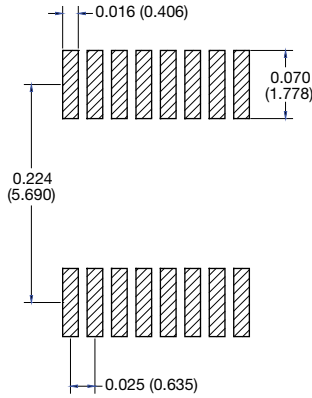

##### OSOP-20, VSSR-20

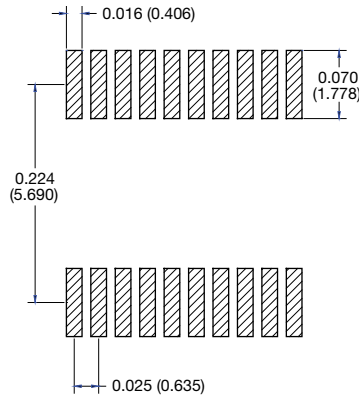

##### OSOP-24, VSSR-24, HD-CSO-24

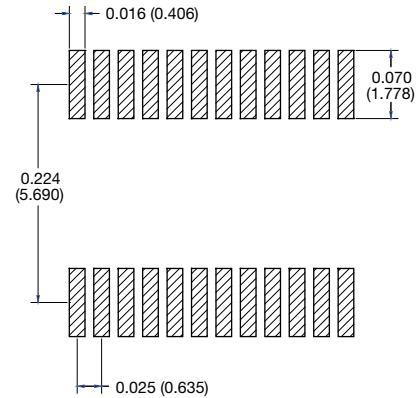

#### TSSOP MO-153

##### VTSR-16

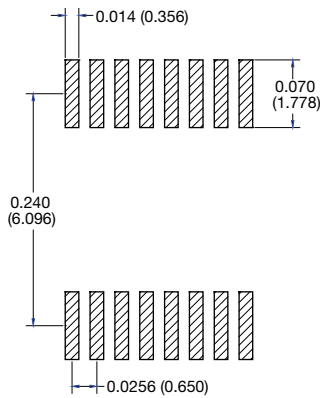

##### VTSR-20

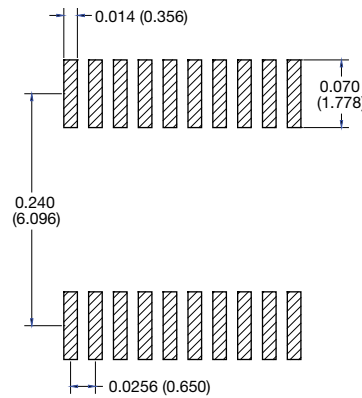

##### VTSR-24

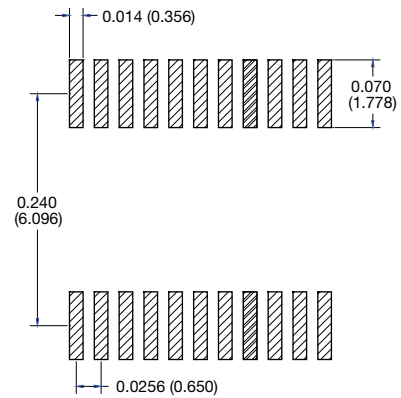



Surface Mount Leadless Networks (LCC Series)

**16 Pin LCC**

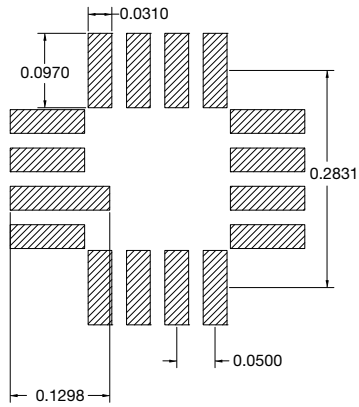

**20 Pin LCC**

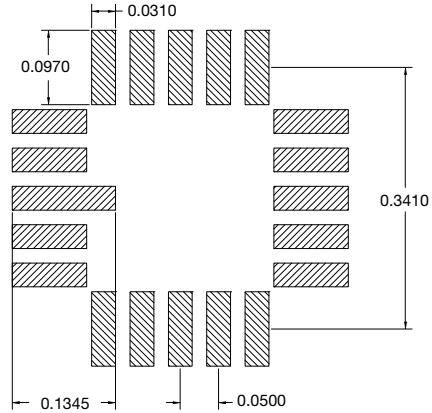

Surface Mount Leadless Networks (MPH Series)

**4 Pin LCC**

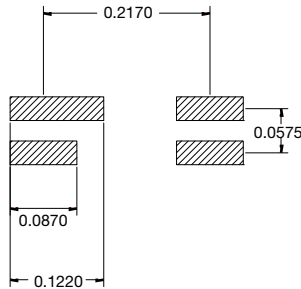

Surface Mount Leadless Packages DUAL/ QUAD Flat No Lead (DFN, QFN Series)

**DFN MLP**

**DFN-8 4 x 5 mm Sq**

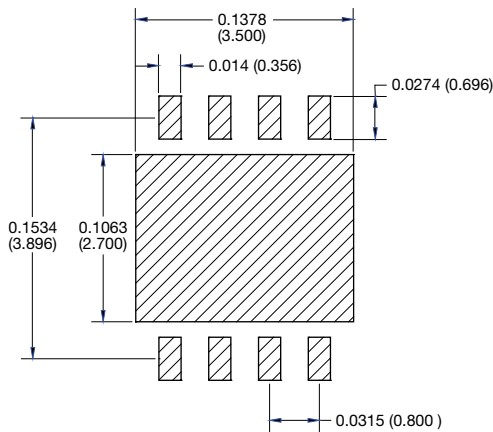

**QFN MLP**

**QFN-20 5 x 5 mm Sq**

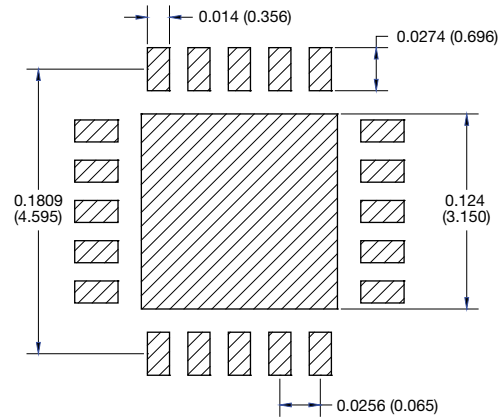

### Surface Mount Leadless Resistor Arrays (PR Series)

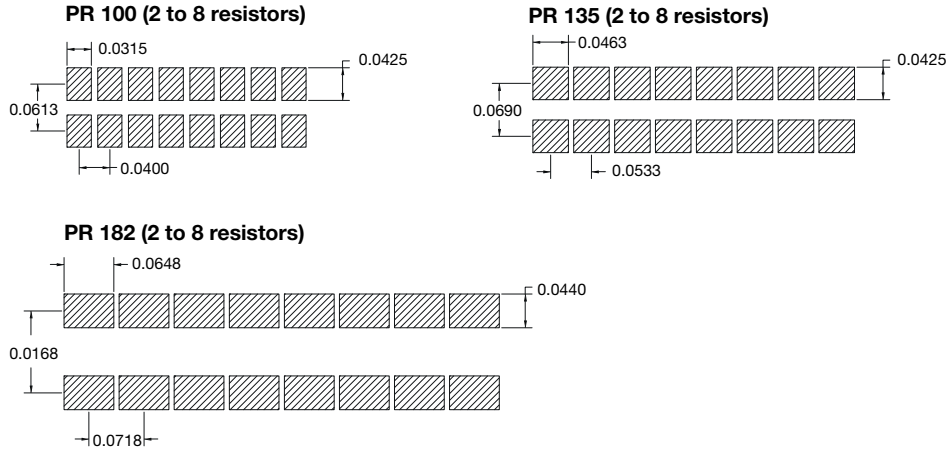

**Note**

- All dimensions in inches (mm)

### Flatpack

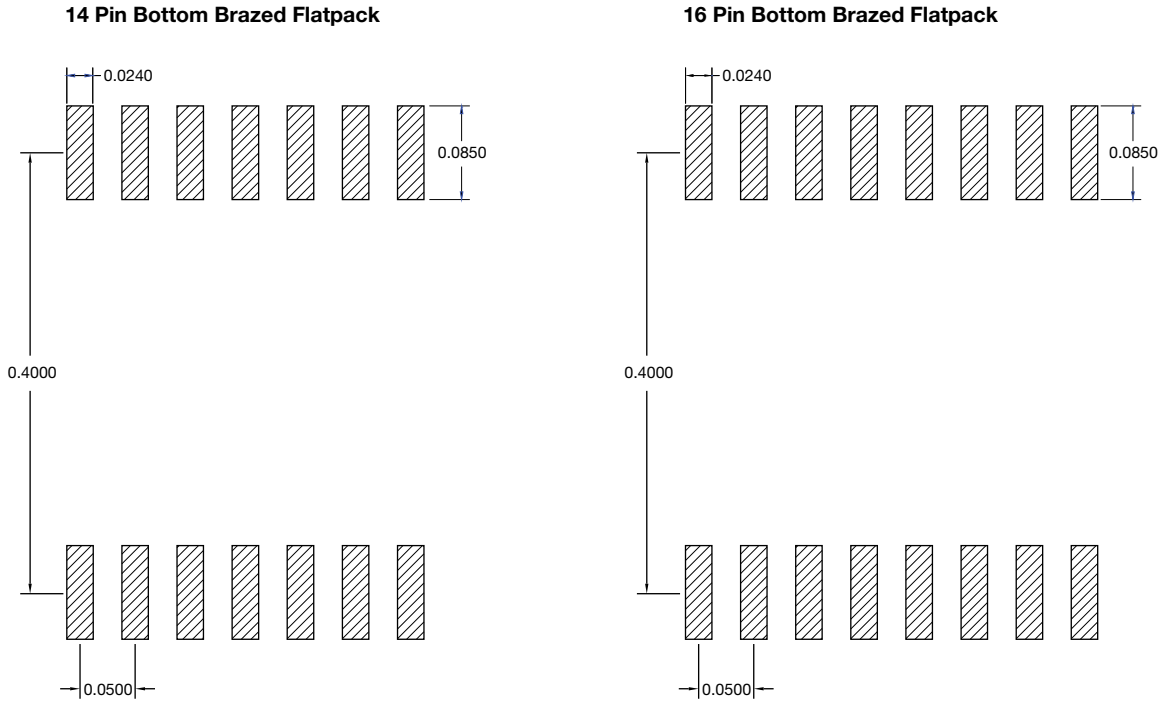



## **Disclaimer**

ALL PRODUCT, PRODUCT SPECIFICATIONS AND DATA ARE SUBJECT TO CHANGE WITHOUT NOTICE TO IMPROVE RELIABILITY, FUNCTION OR DESIGN OR OTHERWISE.

Vishay Intertechnology, Inc., its affiliates, agents, and employees, and all persons acting on its or their behalf (collectively, "Vishay"), disclaim any and all liability for any errors, inaccuracies or incompleteness contained in any datasheet or in any other disclosure relating to any product.

Vishay makes no warranty, representation or guarantee regarding the suitability of the products for any particular purpose or the continuing production of any product. To the maximum extent permitted by applicable law, Vishay disclaims (i) any and all liability arising out of the application or use of any product, (ii) any and all liability, including without limitation special, consequential or incidental damages, and (iii) any and all implied warranties, including warranties of fitness for particular purpose, non-infringement and merchantability.

Statements regarding the suitability of products for certain types of applications are based on Vishay's knowledge of typical requirements that are often placed on Vishay products in generic applications. Such statements are not binding statements about the suitability of products for a particular application. It is the customer's responsibility to validate that a particular product with the properties described in the product specification is suitable for use in a particular application. Parameters provided in datasheets and / or specifications may vary in different applications and performance may vary over time. All operating parameters, including typical parameters, must be validated for each customer application by the customer's technical experts. Product specifications do not expand or otherwise modify Vishay's terms and conditions of purchase, including but not limited to the warranty expressed therein.

Except as expressly indicated in writing, Vishay products are not designed for use in medical, life-saving, or life-sustaining applications or for any other application in which the failure of the Vishay product could result in personal injury or death. Customers using or selling Vishay products not expressly indicated for use in such applications do so at their own risk. Please contact authorized Vishay personnel to obtain written terms and conditions regarding products designed for such applications.

No license, express or implied, by estoppel or otherwise, to any intellectual property rights is granted by this document or by any conduct of Vishay. Product names and markings noted herein may be trademarks of their respective owners.

## X-ON Electronics

Largest Supplier of Electrical and Electronic Components

*Click to view similar products for [Current Sense Resistors - SMD category](#):*

*Click to view products by [Vishay manufacturer](#):*

Other Similar products are found below :

[5112](#) [65709-330JE](#) [PF2512FKF7W0R007L](#) [PR2512FKF7W0R003L](#) [PR2512FKF7W0R005L](#) [RCWL0603R500JNEA](#) [ERJ-3BQF1R1V](#) [ERJ-L14UJ42MU](#) [2-2176088-5](#) [PF2512FKF7W0R006L](#) [PF2512FKF7W0R033L](#) [2-2176089-4](#) [CD2015FC-0.10-1%](#) [PR2512FKF7W0R004L](#) [CGSSL1R01J](#) [CGSSL1R047J](#) [RC1005F124CS](#) [RCWE2512R110FKEA](#) [RCWL0805R330JNEA](#) [RL73H3AR47FTE](#) [RL73K3AR56JTDF](#) [RL7520WT-R001-F](#) [RL7520WT-R009-G](#) [RL7520WT-R020-F](#) [RLP73N1ER43JTD](#) [TL3AR01FTDG](#) [TLR3A20DR0005FTDG](#) [LRC-LR2512LF-01-R820J](#) [ERJ-3BQF4R3V](#) [ERJ-L14UF68MU](#) [TLR3A20DR001FTDG](#) [TLR3A30ER0005FTDG](#) [WR06X104JGLJ](#) [RLP73K1ER82JTD](#) [TL2BR01F](#) [TLR3A20DR01FTDG](#) [WSR3R0600FEA32](#) [ERJ-14BQF1R6U](#) [ERJ-14BQJR30U](#) [SP1220RJT](#) [SP1R12J](#) [ERJ-14BQF6R2U](#) [RL7520WT-R039-G](#) [PF1206FRF7W0R02L](#) [RL7520WT-R002-F](#) [RL7520WT-R047-F](#) [RLP73N2BR068FTDF](#) [RL7520WT-R005-F](#) [RCWE2512R220FKEA](#) [RCWE120625L0FMEA](#)