

Aluminum Electrolytic Capacitors Axial High Temperature, DIN-Based

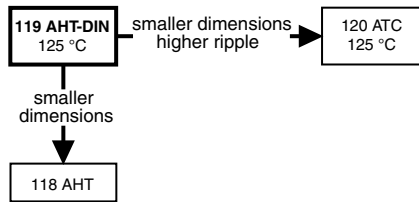


Fig. 1

QUICK REFERENCE DATA	
DESCRIPTION	VALUE
Nominal case sizes (\varnothing D x L in mm)	6.5 x 18 to 10 x 25 10 x 30 to 21 x 38
Rated capacitance range, C_R	4.7 μ F to 4700 μ F
Tolerance on C_R	-10 % / +50 %
Rated voltage range, U_R	10 V to 100 V
Category temperature range	-55 °C to +125 °C
Endurance test at 150 °C	500 h 500 h
Endurance test at 125 °C	2000 h 4000 h
Useful life at 125 °C	4000 h 8000 h
Useful life at 40 °C, 1.8 x I_R applied	500 000 h 1 000 000 h
Shelf life at 0 V, 125 °C: $U_R = 10$ V to 63 V $U_R = 100$ V	500 h 100 h
Based on sectional specification	IEC 60384-4 / EN 130300
Climatic category IEC 60068	55 / 125 / 56

FEATURES

- Extra long useful life: up to 8000 h at 125 °C
- High stability, high reliability
- Extended temperature range: 125 °C (usable up to 150 °C)
- High ripple current capability
- Taped versions up to case \varnothing 15 mm x 30 mm available for automatic insertion
- Polarized aluminum electrolytic capacitors, non-solid electrolyte
- Axial leads, cylindrical aluminum case, insulated with a blue sleeve
- Mounting ring version not available in insulated form
- Charge and discharge proof
- Material categorization: for definitions of compliance please see www.vishay.com/doc?99912


**RoHS
COMPLIANT**

APPLICATIONS

- Military, industrial control, EDP and telecommunication
- Smoothing, filtering, buffering in SMPS; coupling, decoupling
- For use where low mounting height is important; vibration and shock resistant

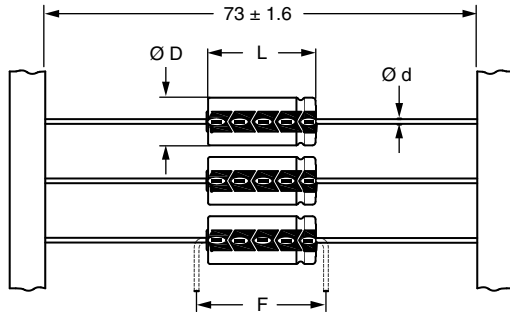
MARKING

The capacitors are marked (where possible) with the following information:

- Rated capacitance (in μ F)
- Tolerance on rated capacitance, code letter in accordance with IEC 60062 (T for -10 % to +50 %)
- Rated voltage (in V) at 125 °C and 85 °C
- Date code, in accordance with IEC 60062
- Code for factory of origin
- Name of manufacturer
- Negative terminal identification
- Series number (119)

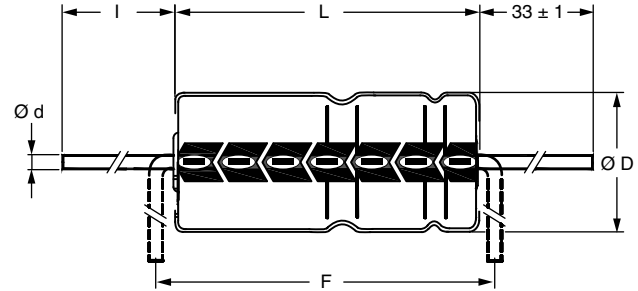
SELECTION CHART FOR C_R , U_R , AND RELEVANT NOMINAL CASE SIZES (\varnothing D x L in mm)						
C_R (μ F)	U_R (V)					
	10	16	25	40	63	100
4.7	-	-	-	-	-	6.5 x 18
10	-	-	-	-	6.5 x 18	-
22	-	-	6.5 x 18	-	8 x 18	-
47	-	6.5 x 18	-	8 x 18	10 x 18	10 x 25
	-	-	-	-	-	10 x 30
68	-	-	-	-	10 x 30	12.5 x 30
100	6.5 x 18	8 x 18	10 x 18	10 x 25	10 x 30	15 x 30
150	-	-	-	12.5 x 30	15 x 30	15 x 30

SELECTION CHART FOR C_R, U_R, AND RELEVANT NOMINAL CASE SIZES ($\varnothing D \times L$ in mm)						
C_R (μF)	U_R (V)					
	10	16	25	40	63	100
220	10 x 18	10 x 25	10 x 25	12.5 x 30	15 x 30	18 x 30
	-	-	12.5 x 30	-	-	-
330	-	12.5 x 30	12.5 x 30	15 x 30	18 x 30	18 x 38
470	10 x 25	12.5 x 30	12.5 x 30	15 x 30	18 x 38	21 x 38
	12.5 x 30	-	-	-	-	-
680	12.5 x 30	15 x 30	18 x 30	18 x 30	21 x 38	-
1000	15 x 30	15 x 30	18 x 30	18 x 38	21 x 38	-
1500	18 x 30	18 x 30	18 x 38	21 x 38	-	-
2200	18 x 30	18 x 38	21 x 38	21 x 38	-	-
3300	18 x 38	21 x 38	-	-	-	-
4700	21 x 38	21 x 38	-	-	-	-

DIMENSIONS in millimeters AND AVAILABLE FORMS


Form BR: Taped on reel
 Case $\varnothing D \times L = 6.5 \text{ mm} \times 18 \text{ mm}$ to $15 \text{ mm} \times 30 \text{ mm}$
Form BA: Taped in box (ammopack)
 Case $\varnothing D \times L = 6.5 \text{ mm} \times 18 \text{ mm}$ to $10 \text{ mm} \times 25 \text{ mm}$

Fig. 2 - Forms BA and BR



Form AA: Axial in box
 Case $\varnothing D \times L = 10 \text{ mm} \times 30 \text{ mm}$ to $21 \text{ mm} \times 38 \text{ mm}$

Fig. 3 - Form AA

Table 1

AXIAL; DIMENSIONS in millimeters, MASS, AND PACKAGING QUANTITIES										
NOMINAL CASE SIZE $\varnothing D \times L$	CASE CODE	AXIAL FORM AA, BA, AND BR					MASS (g)	PACKAGING QUANTITIES		
		$\varnothing d$	l	$\varnothing D_{max.}$	$L_{max.}$	$F_{min.}$		FORM AA	FORM BA	FORM BR
6.5 x 18	4	0.8	-	6.9	18.5	25	≈ 1.3	-	1000	1000
8 x 18	5	0.8	-	8.5	18.5	25	≈ 1.7	-	500	500
10 x 18	6	0.8	-	10.5	18.5	25	≈ 2.5	-	500	500
10 x 25	7	0.8	-	10.5	25.5	30	≈ 3.3	-	500	500
10 x 30	00	0.8	55 ± 1	10.5	30.5	35	≈ 4.8	340	-	500
12.5 x 30	01	0.8	55 ± 1	13.0	30.5	35	≈ 7.4	260	-	400
15 x 30	02	0.8	55 ± 1	15.5	30.5	35	≈ 11.7	200	-	250
18 x 30	03	0.8	55 ± 1	18.5	30.5	35	≈ 12.9	120	-	-
18 x 38	04	0.8	34 ± 1	18.5	39.5	44	≈ 19.0	125	-	-
21 x 38	05	0.8	34 ± 1	21.5	39.5	44	≈ 24.0	100	-	-

Note

- For detailed tape dimensions please see www.vishay.com/doc?28361

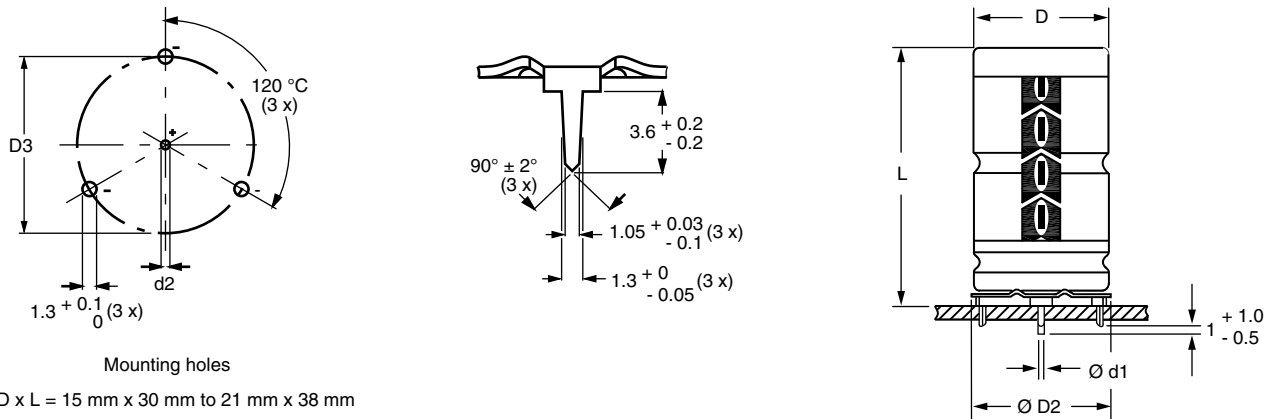

 Fig. 4 - Mounting hole diagram and outline; **form MR:** With mounting ring and pins

Table 2

MOUNTING RING; DIMENSIONS in millimeters, MASS, AND PACKAGING QUANTITIES									
NOMINAL CASE SIZE $\varnothing D \times L$	CASE CODE	MOUNTING RING: FORM MR						MASS (g)	PACKAGING QUANTITIES
		$\varnothing d1$	$\varnothing d2$	$\varnothing D_{max.}$	$\varnothing D2_{max.}$	D3	$L_{max.}$		
15 x 30	02	0.8	1.0 + 0.4	15.5	17.5	16.5 ± 0.2	33	≈ 8.6	200
18 x 30	03	0.8	1.0 + 0.4	18.5	19.5	18.5 ± 0.2	33	≈ 11.5	240
18 x 38	04	0.8	1.0 + 0.4	18.5	19.5	18.5 ± 0.2	42	≈ 14.0	100
21 x 38	05	0.8	1.0 + 0.4	21.5	22.5	21.5 ± 0.2	42	≈ 19.2	100

ELECTRICAL DATA	
SYMBOL	DESCRIPTION
C_R	Rated capacitance at 100 Hz, tolerance -10 % / +50 %
I_R	Rated RMS ripple current at 100 Hz, 125 °C
I_{L1}	Max. leakage current after 1 min at U_R
I_{L5}	Max. leakage current after 5 min at U_R
$\tan \delta$	Max. dissipation factor at 100 Hz
ESR	Equivalent series resistance at 100 Hz (calculated from $\tan \delta_{max.}$ and C_R)
Z	Max. impedance at 10 kHz

Note

- Unless otherwise specified, all electrical values in Table 3 apply at $T_{amb} = 20 \text{ °C}$, $P = 86 \text{ kPa}$ to 106 kPa , $RH = 45 \text{ %}$ to 75 % .

ORDERING EXAMPLE

Electrolytic capacitor 119 series

 470 μF / 16 V; -10 % / +50 %

 Nominal case size: $\varnothing 12.5 \text{ mm} \times 30 \text{ mm}$; form BR

Ordering code: MAL211925471E3

Former 12NC: 2222 119 25471



Table 3

ELECTRICAL DATA AND ORDERING INFORMATION													
U _R (V)	C _R 100 Hz (µF)	NOMINAL CASE SIZE Ø D x L (mm)	CASE CODE	I _R 100 Hz 125 °C (mA)	I _{L1} 1 min (µA)	I _{L5} 5 min (µA)	tan δ 100 Hz	ESR 100 Hz (Ω)	Z 10 kHz (Ω)	ORDERING CODE MAL2119.....			
										IN BOX FORM AA	TAPED ON REEL FORM BR	TAPED IN BOX FORM BA	MOUNTING RING FORM MR
10	100	6.5 x 18	4	130	10	6	0.20	3.50	2.20	-	24101E3	34101E3	-
	220	10 x 18	6	240	17	8.4	0.18	1.30	1.00	-	24221E3	34221E3	-
	470	10 x 25	7	380	32	13	0.18	0.61	0.49	-	90501E3	90502E3	-
	470	12.5 x 30	01	550	32	13	0.16	0.54	0.38	14471E3	24471E3	-	-
	680	12.5 x 30	01	640	45	18	0.20	0.47	0.38	14681E3	24681E3	-	-
	1000	15 x 30	02	830	64	24	0.20	0.32	0.24	14102E3	24102E3	-	44102E3
	1500	18 x 30	03	1100	94	34	0.22	0.23	0.17	14152E3	-	-	44152E3
	2200	18 x 30	03	1190	136	48	0.26	0.19	0.17	14222E3	-	-	44222E3
	3300	18 x 38	04	1550	202	70	0.27	0.13	0.10	14332E3	-	-	44332E3
	4700	21 x 38	05	1700	286	90	0.30	0.10	0.09	14472E3	-	-	44472E3
16	47	6.5 x 18	4	110	10	5.5	0.13	4.40	2.20	-	25479E3	35479E3	-
	100	8 x 18	5	170	14	7.2	0.13	2.10	1.30	-	25101E3	35101E3	-
	220	10 x 25	7	300	25	11	0.13	0.94	0.55	-	25221E3	35221E3	-
	330	12.5 x 30	01	560	36	15	0.13	0.63	0.38	15331E3	25331E3	-	-
	470	12.5 x 30	01	570	50	19	0.15	0.51	0.38	15471E3	25471E3	-	-
	680	15 x 30	02	750	69	26	0.15	0.35	0.24	15681E3	25681E3	-	45681E3
	1000	15 x 30	02	850	100	36	0.19	0.30	0.24	15102E3	25102E3	-	45102E3
	1500	18 x 30	03	1120	148	52	0.20	0.21	0.17	15152E3	-	-	45152E3
	2200	18 x 38	04	1440	215	74	0.20	0.14	0.10	15222E3	-	-	45222E3
	3300	21 x 38	05	1650	321	110	0.22	0.11	0.09	15332E3	-	-	45332E3
4700	21 x 38	05	1710	455	154	0.28	0.09	0.09	15472E3	-	-	45472E3	
25	22	6.5 x 18	4	85	10	5.1	0.10	7.20	3.20	-	26229E3	36229E3	-
	100	10 x 18	6	210	19	9	0.10	1.60	1.00	-	26101E3	36101E3	-
	220	10 x 25	7	350	37	15	0.10	0.72	0.58	-	90503E3	90504E3	-
	220	12.5 x 30	01	500	37	15	0.09	0.65	0.38	16221E3	26221E3	-	-
	330	12.5 x 30	01	580	54	21	0.11	0.53	0.38	16331E3	26331E3	-	-
	470	12.5 x 30	01	630	75	28	0.13	0.44	0.38	16471E3	26471E3	-	-
	680	18 x 30	03	990	106	38	0.13	0.30	0.17	16681E3	-	-	46681E3
	1000	18 x 30	03	1090	154	54	0.13	0.21	0.17	16102E3	-	-	46102E3
	1500	18 x 38	04	1420	229	79	0.13	0.14	0.10	16152E3	-	-	46152E3
	2200	21 x 38	05	1550	334	114	0.13	0.11	0.09	16222E3	-	-	46222E3
40	47	8 x 18	5	150	15	7.8	0.08	2.70	1.50	-	27479E3	37479E3	-
	100	10 x 25	7	260	28	12	0.08	1.30	0.70	-	27101E3	37101E3	-
	150	12.5 x 30	01	440	40	16	0.08	0.85	0.51	17151E3	27151E3	-	-
	220	12.5 x 30	01	500	57	22	0.09	0.65	0.48	17221E3	27221E3	-	-
	330	15 x 30	02	630	83	30	0.09	0.43	0.37	17331E3	27331E3	-	47331E3
	470	15 x 30	02	720	117	42	0.12	0.41	0.37	17471E3	27471E3	-	47471E3
	680	18 x 30	03	970	167	58	0.12	0.28	0.22	17681E3	-	-	47681E3
	1000	18 x 38	04	1250	244	84	0.12	0.19	0.14	17102E3	-	-	47102E3
	1500	21 x 38	05	1410	364	124	0.14	0.15	0.12	17152E3	-	-	47152E3
	2200	21 x 38	05	1550	532	180	0.18	0.13	0.11	17222E3	-	-	47222E3



ELECTRICAL DATA AND ORDERING INFORMATION													
U _R (V)	C _R 100 Hz (μF)	NOMINAL CASE SIZE Ø D x L (mm)	CASE CODE	I _R 100 Hz 125 °C (mA)	I _{L1} 1 min (μA)	I _{L5} 5 min (μA)	tan δ 100 Hz	ESR 100 Hz (Ω)	Z 10 kHz (Ω)	ORDERING CODE MAL2119.....			
										IN BOX FORM AA	TAPED ON REEL FORM BR	TAPED IN BOX FORM BA	MOUNTING RING FORM MR
63	10	6.5 x 18	4	68	20	5.3	0.07	11.0	5.60	-	28109E3	38109E3	-
	22	8 x 18	5	110	20	6.7	0.07	5.10	2.80	-	28229E3	38229E3	-
	47	10 x 18	6	180	22	9.9	0.07	2.40	1.30	-	28479E3	38479E3	-
	68	10 x 25	7	230	30	13	0.07	1.60	1.00	-	90505E3	90506E3	-
	68	10 x 30	00	300	30	13	0.07	1.60	0.92	18689E3	28689E3	-	-
	100	10 x 30	00	360	42	17	0.08	1.30	0.75	18101E3	28101E3	-	-
	150	15 x 30	02	560	61	23	0.08	0.85	0.37	18151E3	28151E3	-	48151E3
	220	15 x 30	02	640	87	32	0.08	0.58	0.37	18221E3	28221E3	-	48221E3
	330	18 x 30	03	880	129	46	0.09	0.43	0.23	18331E3	-	-	48331E3
	470	18 x 38	04	1130	182	63	0.09	0.30	0.15	18471E3	-	-	48471E3
	680	21 x 38	05	1290	261	90	0.09	0.21	0.12	18681E3	-	-	48681E3
1000	21 x 38	05	1430	382	130	0.10	0.16	0.11	18102E3	-	-	48102E3	
100	4.7	6.5 x 18	4	44	20	10	0.08	27.00	10.0	-	29478E3	39478E3	-
	47	10 x 25	7	178	32	13	0.08	2.70	2.00	-	90518E3	90519E3	-
	47	10 x 30	00	240	32	13	0.08	2.70	2.00	19479E3	29479E3	-	-
	68	12.5 x 30	01	330	45	18	0.08	1.90	1.20	19689E3	29689E3	-	-
	100	15 x 30	02	440	64	24	0.09	1.40	0.96	19101E3	29101E3	-	49101E3
	150	15 x 30	02	520	94	34	0.10	1.10	0.78	19151E3	29151E3	-	49151E3
	220	18 x 30	03	710	136	48	0.10	0.72	0.55	19221E3	-	-	49221E3
	330	18 x 38	04	920	202	70	0.10	0.48	0.37	19331E3	-	-	49331E3
470	21 x 38	05	1070	286	98	0.10	0.34	0.28	19471E3	-	-	49471E3	

ADDITIONAL ELECTRICAL DATA		
PARAMETER	CONDITIONS	VALUE
		AXIAL
Voltage		
Surge voltage		$U_s \leq 1.15 \times U_R$
Reverse voltage		$U_{rev} \leq 1 V$
Current		
Leakage current	After 1 min: $U_R = 10 V$ to $40 V$ $U_R = 63 V$ to $100 V$	$I_{L1} \leq 0.006 C_R \times U_R + 4 \mu A$, or $10 \mu A$ (whichever is greater) $I_{L1} \leq 0.006 C_R \times U_R + 4 \mu A$, or $20 \mu A$ (whichever is greater)
	After 5 min: $U_R = 10 V$ to $63 V$ $U_R = 100 V$	$I_{L5} \leq 0.002 C_R \times U_R + 4 \mu A$ $I_{L5} \leq 0.002 C_R \times U_R + 4 \mu A$, or $10 \mu A$ (whichever is greater)

ADDITIONAL ELECTRICAL DATA			
PARAMETER	CONDITIONS	VALUE	
		AXIAL	MOUNTING RING
Inductance			
Equivalent series inductance (ESL)	Case Ø D x L mm:		
	6.5 x 18	Typ. 15 nH	-
	8 x 18	Typ. 35 nH	-
	10 x 18	Typ. 69 nH	-
	10 x 25	Typ. 38 nH	-
	10 x 30	Typ. 38 nH	-
	12.5 x 30	Typ. 46 nH	-
	15 x 30	Typ. 48 nH	Typ. 39 nH
	18 x 30	Typ. 50 nH	Typ. 39 nH
	18 x 38	Typ. 54 nH	Typ. 39 nH
21 x 38	Typ. 59 nH	Typ. 39 nH	

Table 4

OPERATING VALUES AT REDUCED AMBIENT TEMPERATURE								
SYMBOL	CONDITIONS	VALUES						UNIT
U_R	$T_{amb} > 85\text{ °C}$ to 125 °C	10	16	25	40	63	100	V
U_{R2}	$T_{amb} \leq 85\text{ °C}$	16	25	40	63	100	125	

Note

- For applications at ambient temperatures of $\leq 85\text{ °C}$, the rated voltage (U_R) may be raised to U_{R2} .

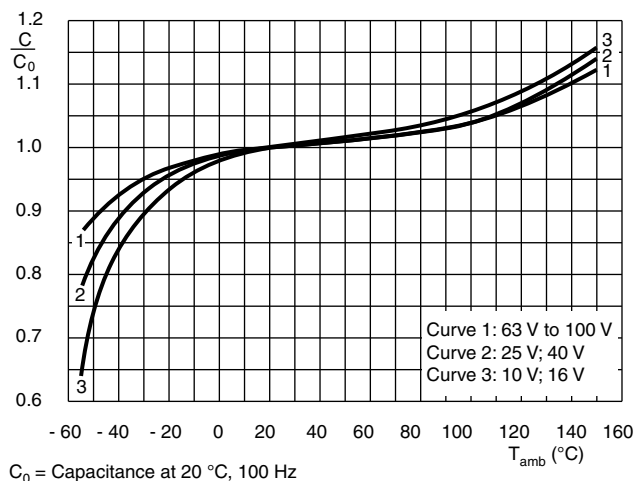
CAPACITANCE (C)


Fig. 5 - Typical multiplier of capacitance as a function of ambient temperature

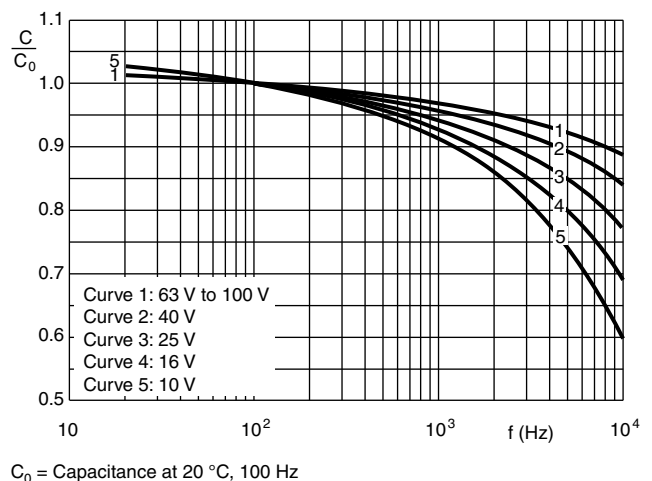
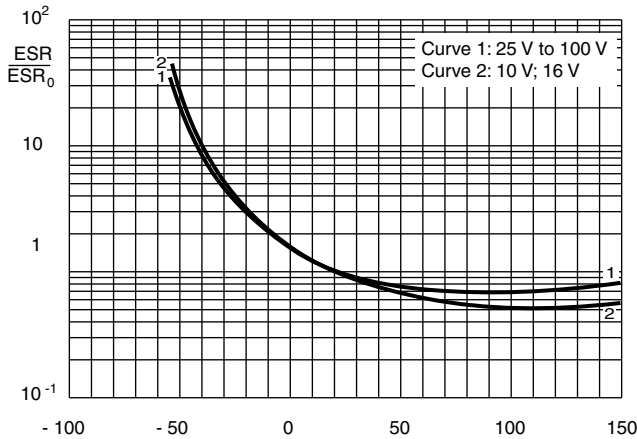


Fig. 6 - Typical multiplier of capacitance as a function of ambient temperature

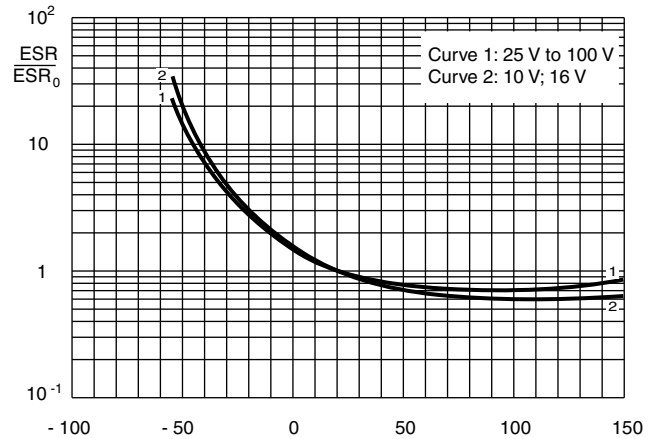


EQUIVALENT SERIES RESISTANCE (ESR)



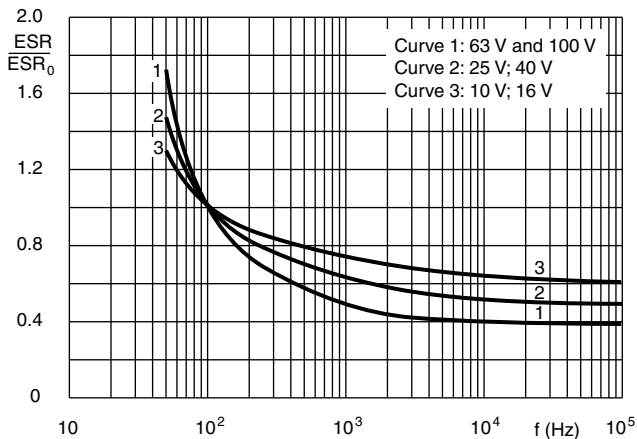
Case Ø D x L = 6.5 mm x 18 mm to 15 mm x 30 mm
ESR₀ = Typical at 20 °C, 100 Hz

Fig. 7 - Typical multiplier of ESR as a function of ambient temperature



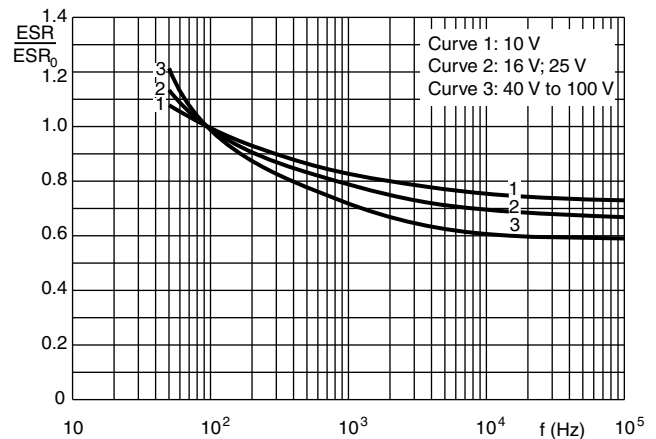
Case Ø D x L = 18 mm x 30 mm to 21 mm x 38 mm
ESR₀ = Typical at 20 °C, 100 Hz

Fig. 8 - Typical multiplier of ESR as a function of ambient temperature



Case Ø D x L = 6.5 mm x 18 mm to 10 mm x 25 mm
ESR₀ = Typical at 20 °C, 100 Hz

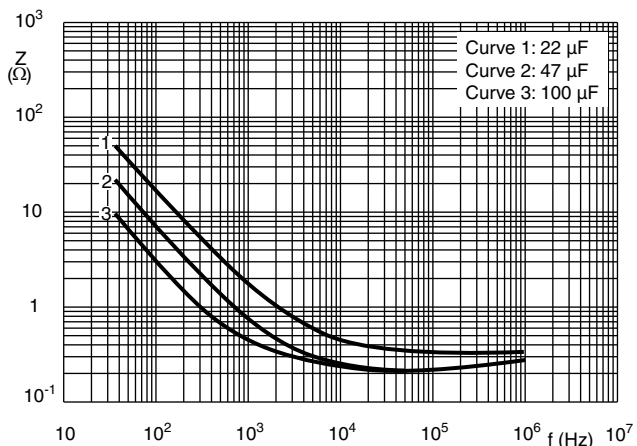
Fig. 9 - Typical multiplier of ESR as a function of frequency



Case Ø D x L = 10 mm x 30 mm to 21 mm x 38 mm
ESR₀ = Typical at 20 °C, 100 Hz

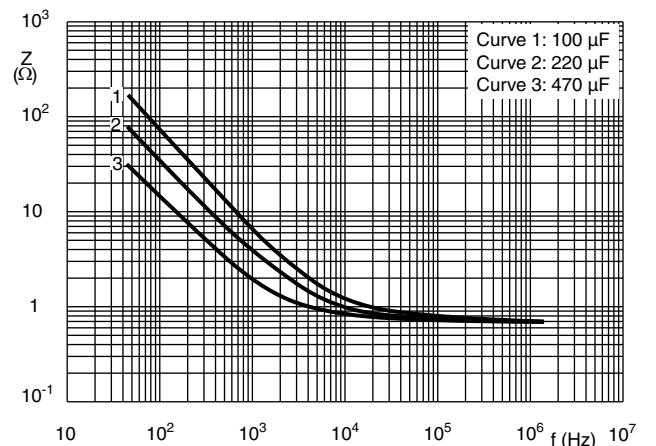
Fig. 10 - Typical multiplier of ESR as a function of frequency

IMPEDANCE (Z)



Case Ø D x L = 8 mm x 18 mm

Fig. 11 - Typical impedance as a function of frequency



Case Ø D x L = 8 mm x 18 mm

Fig. 12 - Typical impedance as a function of frequency
T_{amb} (°C)



IMPEDANCE (Z)

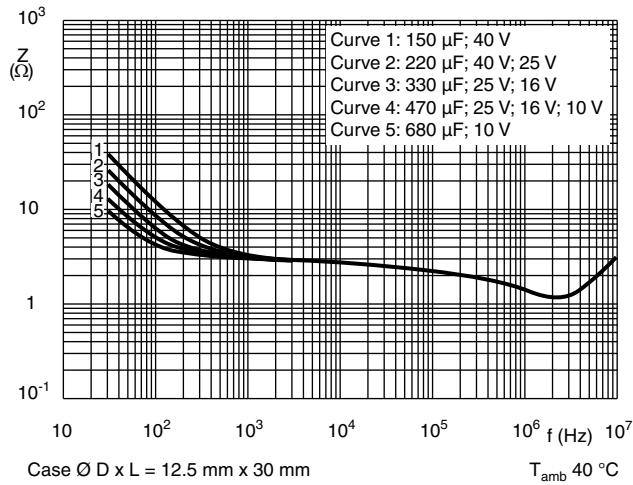


Fig. 13 - Typical impedance as a function of frequency

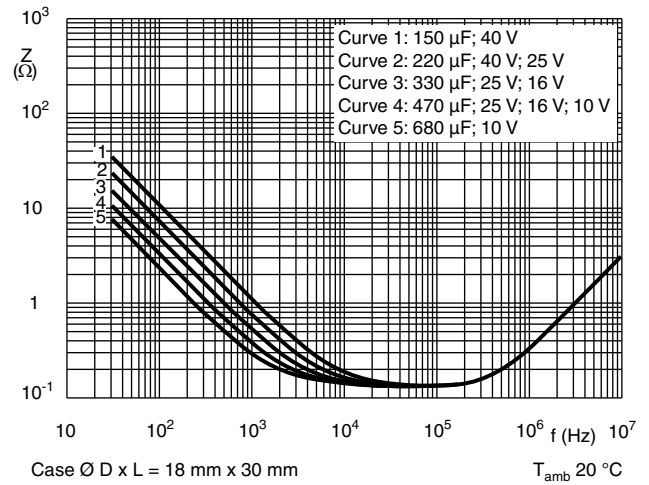


Fig. 14 - Typical impedance as a function of frequency

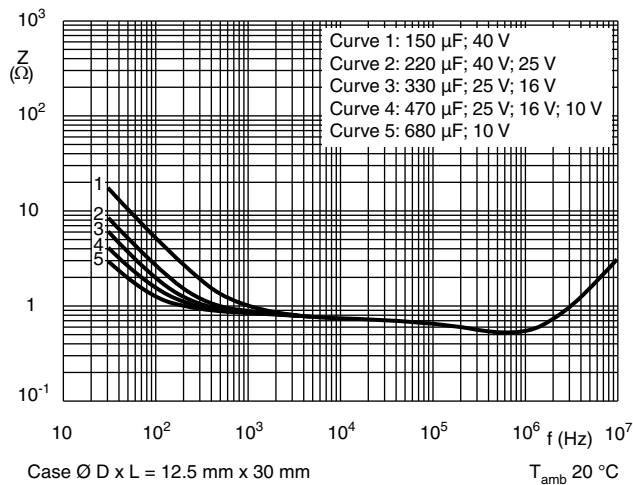


Fig. 15 - Typical impedance as a function of frequency

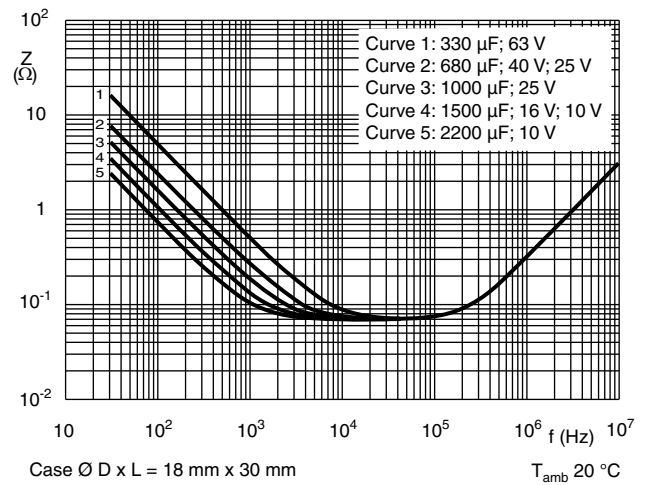


Fig. 16 - Typical impedance as a function of frequency

RIPPLE CURRENT AND USEFUL LIFE

Table 5

ENDURANCE TEST DURATION AND USEFUL LIFE		
NOMINAL CASE SIZE Ø D x L (mm)	ENDURANCE AT 125 °C (h)	USEFUL LIFE AT 125 °C (h)
6.5 x 18	2000	4000
8 x 18	2000	4000
10 x 18	2000	4000
10 x 25	2000	4000
10 x 30	4000	8000
12.5 x 30	4000	8000
15 x 30	4000	8000
18 x 30	4000	8000
18 x 38	4000	8000
21 x 38	4000	8000

Note

- Multiplier of useful life code: MBC242

MBC242

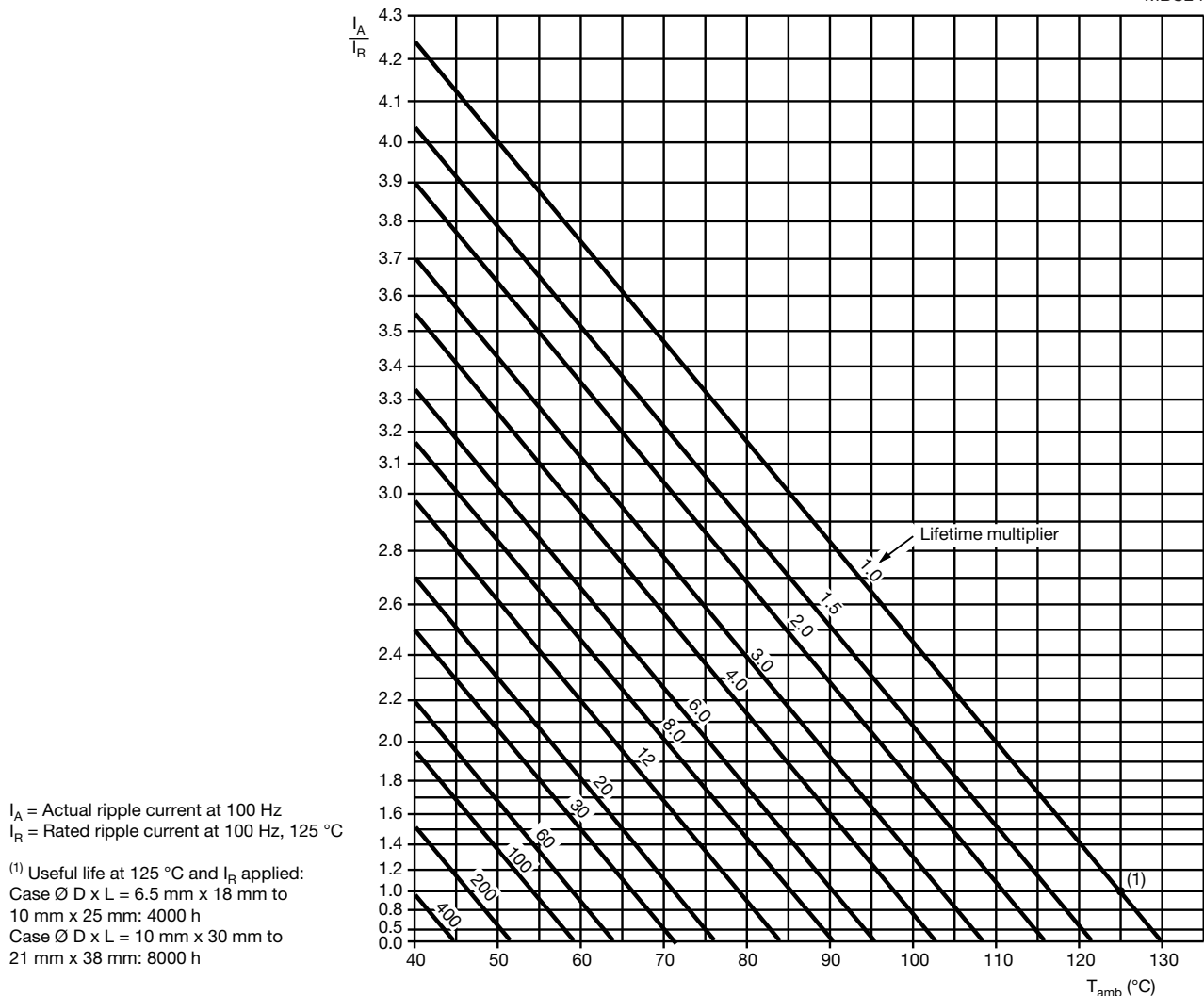


Fig. 17 - Multiplier of useful life as a function of ambient temperature and ripple current load

Table 6

MULTIPLIER OF RIPPLE CURRENT (I_R) AS A FUNCTION OF FREQUENCY						
U_R (V)	FREQUENCY (Hz)					
	50	100	300	1000	3000	$\geq 10\ 000$
	I_R MULTIPLIER					
10	0.95	1.00	1.07	1.12	1.15	1.20
16	0.95	1.00	1.07	1.12	1.15	1.20
25	0.90	1.00	1.12	1.20	1.25	1.30
40	0.90	1.00	1.12	1.20	1.25	1.30
63	0.85	1.00	1.20	1.30	1.35	1.40
100	0.85	1.00	1.20	1.30	1.35	1.40

Table 7

TEST PROCEDURES AND REQUIREMENTS			
TEST		PROCEDURE (quick reference)	REQUIREMENTS
NAME OF TEST	REFERENCE		
Endurance	IEC 60384-4 / EN 130300 subclause 4.13	$T_{amb} = 125\ ^\circ\text{C}$; U_R applied; Case $\varnothing D \times L = 6.5\ \text{mm} \times 18\ \text{mm}$ to 10 mm x 25 mm: 2000 h; Case $\varnothing D \times L = 10\ \text{mm} \times 30\ \text{mm}$ to 21 mm x 38 mm: 4000 h	$\Delta C/C: \pm 15\ \%$ $\tan \delta \leq 1.3 \times \text{spec. limit}$ $Z \leq 2 \times \text{spec. limit}$ $I_{L5} \leq \text{spec. limit}$
Useful life	CECC 30301 subclause 1.8.1	$T_{amb} = 125\ ^\circ\text{C}$; U_R and I_R applied; Case $\varnothing D \times L = 6.5\ \text{mm} \times 18\ \text{mm}$ to 10 mm x 25 mm: 4000 h; Case $\varnothing D \times L = 10\ \text{mm} \times 30\ \text{mm}$ to 21 mm x 38 mm: 8000 h	$\Delta C/C: \pm 45\ \%$ $\tan \delta \leq 3 \times \text{spec. limit}$ $Z \leq 3 \times \text{spec. limit}$ $I_{L5} \leq \text{spec. limit}$ no short or open circuit total failure percentage: $\leq 1\ \%$
Shelf life (storage at high temperature)	IEC 60384-4 / EN 130300 subclause 4.17	$T_{amb} = 125\ ^\circ\text{C}$; no voltage applied; $U_R = 10\ \text{V}$ to 63 V: 500 h; $U_R = 100\ \text{V}$: 100 h After test: U_R to be applied for 30 min, 24 h to 48 h before measurement	$\Delta C/C, \tan \delta, Z$: for requirements see "Endurance test" above $I_{L5} \leq 2 \times \text{spec. limit}$
Reverse voltage	IEC 60384-4 / EN 130300 subclause 4.15	$T_{amb} = 125\ ^\circ\text{C}$: 125 h at $U = -1\ \text{V}$ followed by 125 h at U_R	$\Delta C/C: \pm 20\ \%$ $\tan \delta \leq \text{spec. limit}$ $I_{L5} \leq \text{spec. limit}$

Statements about product lifetime are based on calculations and internal testing. They should only be interpreted as estimations. Also due to external factors, the lifetime in the field application may deviate from the calculated lifetime. In general, nothing stated herein shall be construed as a guarantee of durability.



Disclaimer

ALL PRODUCT, PRODUCT SPECIFICATIONS AND DATA ARE SUBJECT TO CHANGE WITHOUT NOTICE TO IMPROVE RELIABILITY, FUNCTION OR DESIGN OR OTHERWISE.

Vishay Intertechnology, Inc., its affiliates, agents, and employees, and all persons acting on its or their behalf (collectively, "Vishay"), disclaim any and all liability for any errors, inaccuracies or incompleteness contained in any datasheet or in any other disclosure relating to any product.

Vishay makes no warranty, representation or guarantee regarding the suitability of the products for any particular purpose or the continuing production of any product. To the maximum extent permitted by applicable law, Vishay disclaims (i) any and all liability arising out of the application or use of any product, (ii) any and all liability, including without limitation special, consequential or incidental damages, and (iii) any and all implied warranties, including warranties of fitness for particular purpose, non-infringement and merchantability.

Statements regarding the suitability of products for certain types of applications are based on Vishay's knowledge of typical requirements that are often placed on Vishay products in generic applications. Such statements are not binding statements about the suitability of products for a particular application. It is the customer's responsibility to validate that a particular product with the properties described in the product specification is suitable for use in a particular application. Parameters provided in datasheets and / or specifications may vary in different applications and performance may vary over time. All operating parameters, including typical parameters, must be validated for each customer application by the customer's technical experts. Product specifications do not expand or otherwise modify Vishay's terms and conditions of purchase, including but not limited to the warranty expressed therein.

Except as expressly indicated in writing, Vishay products are not designed for use in medical, life-saving, or life-sustaining applications or for any other application in which the failure of the Vishay product could result in personal injury or death. Customers using or selling Vishay products not expressly indicated for use in such applications do so at their own risk. Please contact authorized Vishay personnel to obtain written terms and conditions regarding products designed for such applications.

No license, express or implied, by estoppel or otherwise, to any intellectual property rights is granted by this document or by any conduct of Vishay. Product names and markings noted herein may be trademarks of their respective owners.

X-ON Electronics

Largest Supplier of Electrical and Electronic Components

Click to view similar products for [Aluminum Electrolytic Capacitors - Leaded](#) category:

Click to view products by [Vishay](#) manufacturer:

Other Similar products are found below :

[LXY50VB4.7M-5X11](#) [MAL203125221E3](#) [MAL204216159E3](#) [ESMG101ETD100MF11S](#) [RBC-25V-10UF-4X7](#) [RE3-35V222MJ6#](#) [RFO-100V471MJ7P#](#) [B41041A2687M8](#) [B41041A7226M8](#) [B41044A7157M6](#) [EKRG250ELL100MD07D](#) [EKXG201EC3101ML20S](#)
[EKXG351ETD6R8MJ16S](#) [EKZM160ETD471MHB5D](#) [EPA-201ELL151MM25S](#) [NCD681K10KVY5PF](#) [NRLF103M25V35X20F](#)
[KM4700/16](#) [KME50VB100M-8X11.5](#) [RXJ222M1EBK-1625](#) [SG220M1CSA-0407](#) [ES5107M016AE1DA](#) [ESX472M16B](#) [MAL211929479E3](#)
[40D506F050DF5A](#) [TE1202E](#) [36DA273F050BB2A](#) [KME25VB100M-6.3X11](#) [511D336M250EK5D](#) [511D337M035CG4D](#)
[515D477M035CG8PE3](#) [052687X](#) [EKMA500ELL4R7ME07D](#) [EKRG100ETC221MF09D](#) [NRE-S560M16V6.3X7TBSTF](#)
[ERZA630VHN182UP54N](#) [MAL214099813E3](#) [MAL211990518E3](#) [MAL204281229E3](#) [NEV680M35EF](#) [686KXM050M](#) [ERS1VM222L30OT](#)
[EGW2GM150W16OT](#) [EGS2GM6R8G12OC](#) [EHS2GM220W20OT](#) [ERF1VM222L30OT](#) [ERF1KM151G20OT](#) [EKZE500ELL101MHB5D](#)
[EKMM251VSN221MP25S](#) [RGA221M1HBK-1016G](#)