

Molded, 50 mil Pitch, Dual-In-Line Thin Film Divider, Surface Mount Resistor Network

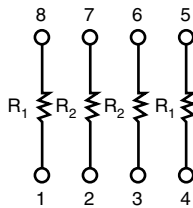

Vishay Dale Thin Film ORN series Dividers provide optimum ratio precision, small size and exceptional stability for most applications. They offer a wide ratio range that is listed in the selection guide and are available for immediate delivery. The tight ratio tolerance offered on the standard ratios will provide exceptional performance throughout life.

SCHEMATIC



FEATURES

- 0.068" (1.73 mm) maximum seated height
- Rugged molded case construction with no internal solder (JEDEC MS-012 variation AA package)
- Low TCR tracking ± 5 ppm/ $^{\circ}\text{C}$
- Compliant to RoHS Directive 2002/95/EC
- Halogen-free according to IEC 61249-2-21 definition



RoHS*
COMPLIANT
HALOGEN
FREE

Note

* Pb containing terminations are not RoHS compliant, exemptions may apply

TYPICAL PERFORMANCE

	ABSOLUTE	TRACKING
TCR	25	5
	ABSOLUTE	RATIO
TOL.	0.1	0.05

STANDARD RESISTANCE OFFERING (R_1/R_2)

RATIO	R_1	R_2
100:1	100K	1K
50:1	50K	1K
25:1	25K	1K
20:1	20K	1K
10:1	10K	1K
5:1	10K	2K
2:1	10K	5K

STANDARD ELECTRICAL SPECIFICATIONS

TEST	SPECIFICATIONS	CONDITIONS
Material	Passivated nichrome	-
Pin/Lead Number	8	-
Resistance Range	1000 Ω to 100 k Ω per resistor	-
TCR: Absolute	± 25 ppm/ $^{\circ}\text{C}$	- 55 $^{\circ}\text{C}$ to + 125 $^{\circ}\text{C}$
TCR: Tracking	± 5 ppm/ $^{\circ}\text{C}$	- 55 $^{\circ}\text{C}$ to + 125 $^{\circ}\text{C}$
Tolerance: Absolute	± 0.1 %	+ 25 $^{\circ}\text{C}$
Tolerance: Ratio	± 0.05 %	+ 25 $^{\circ}\text{C}$
Power Rating: Resistor	100 mW	Maximum at + 70 $^{\circ}\text{C}$
Power Rating: Package	400 mW	Maximum at + 70 $^{\circ}\text{C}$
Stability: Absolute	$\Delta R \pm 0.05$ %	2000 h at + 70 $^{\circ}\text{C}$
Stability: Ratio	$\Delta R \pm 0.015$ %	2000 h at + 70 $^{\circ}\text{C}$
Voltage Coefficient	< 0.1 ppm/V	-
Working Voltage	100 V max. not to exceed $\sqrt{P \times R}$	-
Operating Temperature Range	- 55 $^{\circ}\text{C}$ to + 125 $^{\circ}\text{C}$	-
Storage Temperature Range	- 55 $^{\circ}\text{C}$ to + 150 $^{\circ}\text{C}$	-
Noise	< - 30 dB	-
Thermal EMF	0.08 $\mu\text{V}/^{\circ}\text{C}$	-
Shelf Life Stability: Absolute	$\Delta R \pm 0.01$ %	1 year at + 25 $^{\circ}\text{C}$
Shelf Life Stability: Ratio	$\Delta R \pm 0.002$ %	1 year at + 25 $^{\circ}\text{C}$

Note

- Tantalum nitride film is custom, consult factory

DIMENSIONS AND IMPRINTING in inches and millimeters			
	DIMENSION	INCHES	MILLIMETERS
	A	0.157	3.99
	B	0.0165 ± 0.005	0.4 ± 0.06
	C	0.050	1.27
	D	0.195 max.	4.93
	E	0.008 ± 0.001	0.20 ± 0.03
	F	0.028 ± 0.001	0.71 ± 0.02
	G	0.239 ± 0.005	6.07 ± 0.13
	H	0.068 max.	1.73
	I	0.008 ± 0.002	0.22 ± 0.06
Ø	2° to 6°	2° to 6°	

Note

- Marking - Vishay symbol, part number from ordering information

MECHANICAL SPECIFICATIONS	
Resistive Element	Passivated nichrome
Substrate Material	Silicon
Body	Molded epoxy
Terminals	Copper alloy
Lead (Pb)-free Option	100 % matte tin
Tin Lead Option	Sn90
Tin Lead and Lead (Pb)-free Finish	Plated



GLOBAL PART NUMBER INFORMATION												
New Global Part Numbering: ORNA5-1UF												
	O	R	N	A		5	-	1		U	F	
	O	R	N	T	A	1	0	0	-	1	U	F
GLOBAL MODEL (4 or 5 digits)	RESISTANCE (3, 4 or 5 digits)				PACKAGING							
ORNA (Tin/lead)	2-1 5-1 10-1 20-1 25-1 50-1 100-1				TAPE AND REEL T0 = 100 min., 100 mult T1 = 1000 min., 1000 mult T3 = 300 min., 300 mult T5 = 500 min., 500 mult TF = Full reel 3000 TS = 100 min., 1 mult UF = TUBED							
ORNTA (Lead (Pb)-free) (e3)												
Historical Part Number example: ORNA2-1 (for reference purposes only)												
ORNA2-1	2:1	10K	5K	2								
PART NUMBER	DIVIDER NETWORK	R ₁ VALUE	R ₂ VALUE	R ₁ /R ₂ RATIO								



Vishay Dale Thin Film Land Patterns

1. Scope

This technical note provides sample land patterns for Vishay Dale Thin Film SMT resistive products. The following drawings are based on IPC-SM-782 Surface Mount Design and Land Pattern Standard. These drawings are for reference only Vishay Thin Film recommends that the user contacts their PC board supplier for actual land patterns required. The pads are intended for lead (Pb)-free and tin / lead solder types.

2. Product Series

Thin Film Surface Mount Chip Resistors (FC, L, P, PTN, PLT, PLTT, PLTU, PAT, PATT, PNM, M/D55342 QPL Series)

0402 Land Pattern

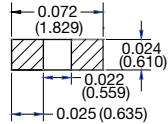

0502 Land Pattern

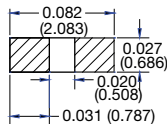

0505 Land Pattern

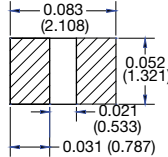

0603 Land Pattern

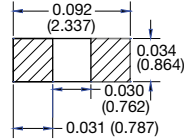

0705 Land Pattern

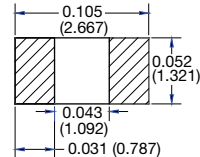

1005 Land Pattern

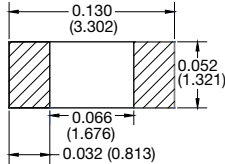

1010 Land Pattern

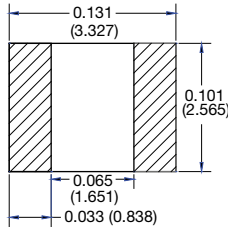

1206 Land Pattern

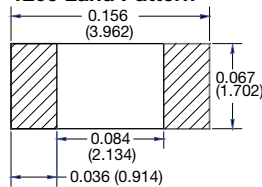

1505 Land Pattern

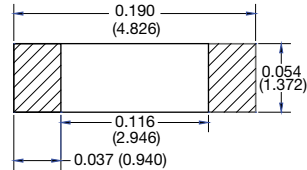

2010 Land Pattern

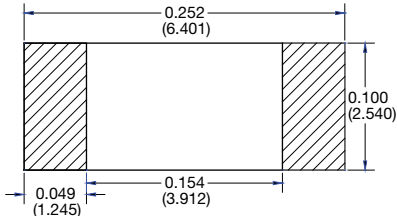

2208 Land Pattern

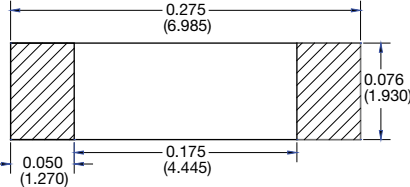

2512 Land Pattern

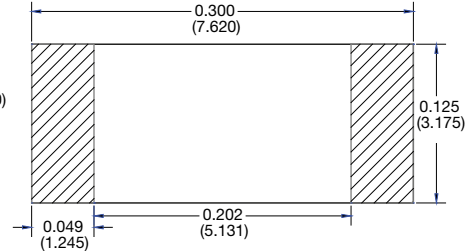



Thin Film Surface Mount Chip Resistors (PHP, PCAN Series)

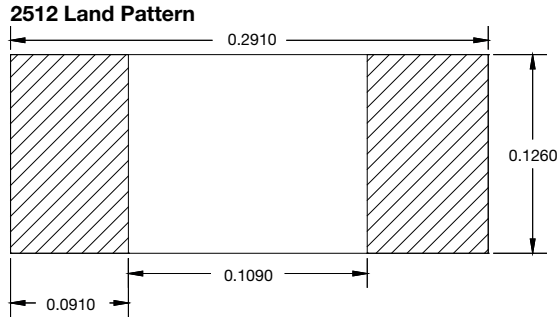
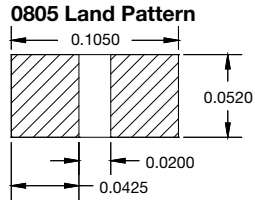
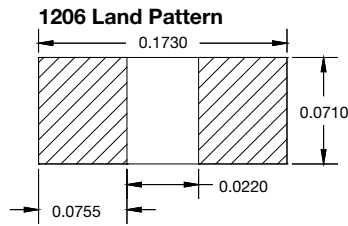
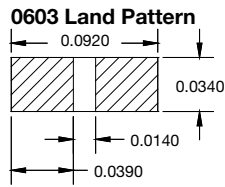

Thin Film Surface Mount Chip Resistors Long Axis Termination (L Series)

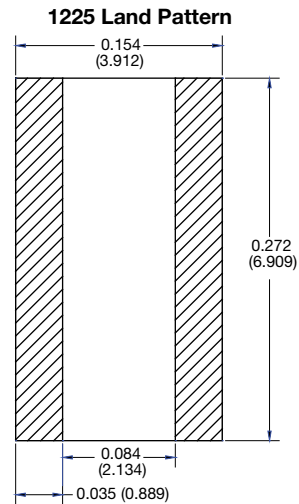
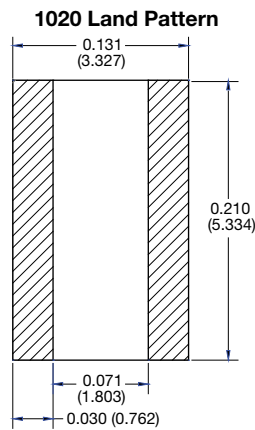
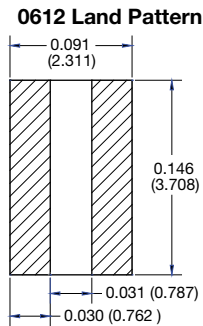
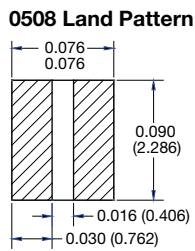



Surface Mount Networks (MPM, MP3, MP4 Series)

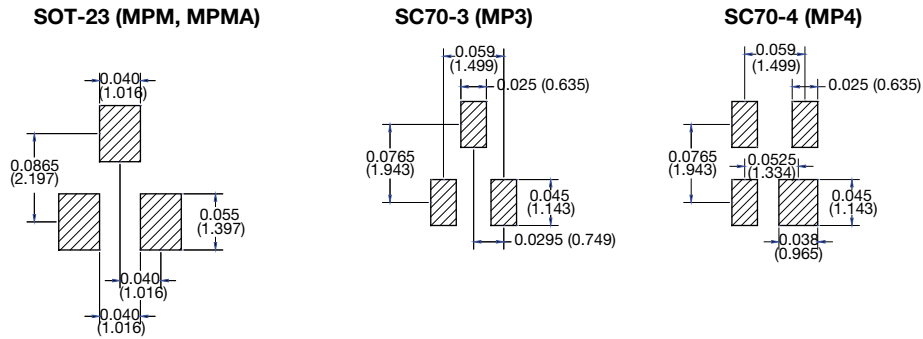

Surface Mount Networks SOIC Narrow Body 150 mils (ORN, CSO, MOMC, HTRN, AORN, MORN Series)

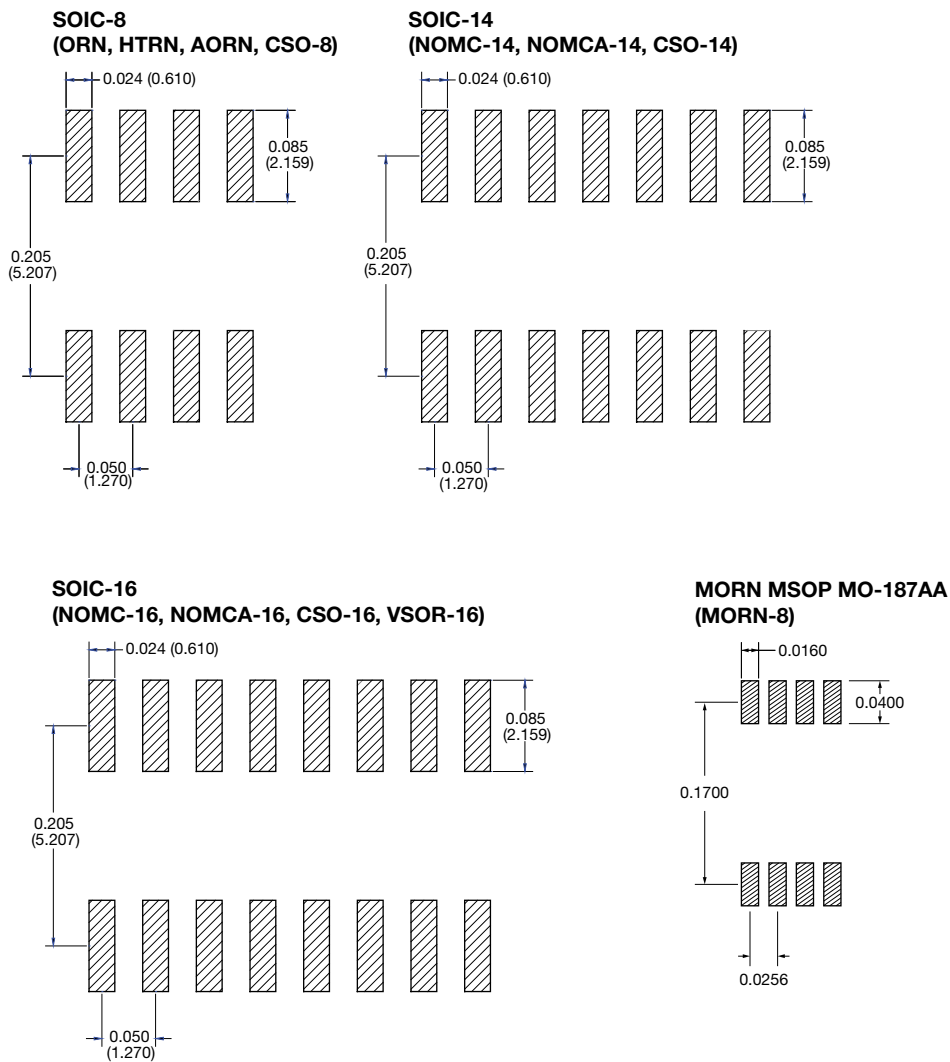



Surface Mount Networks SOIC Medium Body 220 mils (TOMC Series)

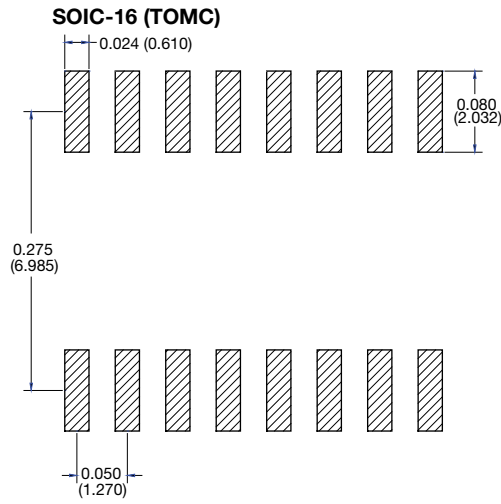

Surface Mount Networks SOIC Wide Body 300 mils (WOMC Series)

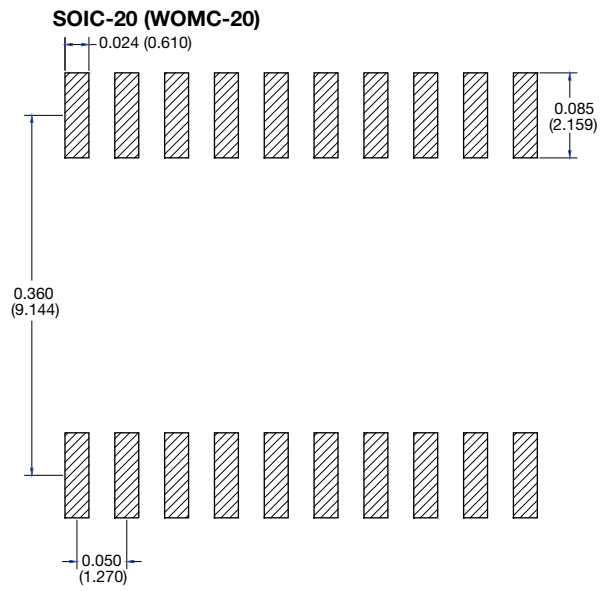
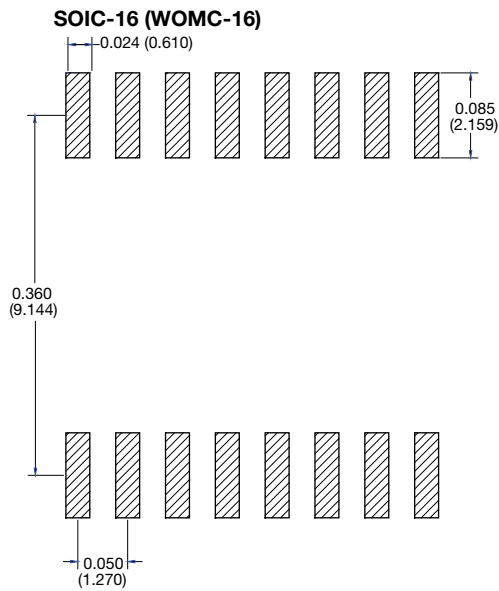



Surface Mount Networks High Density SSOP, TSOP (VSSR, VTSR Series)

SSOP MO-137

OSOP-16, VSSR-16

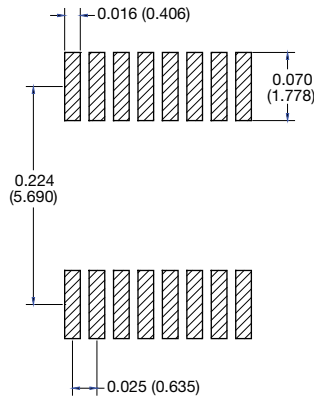

OSOP-20, VSSR-20

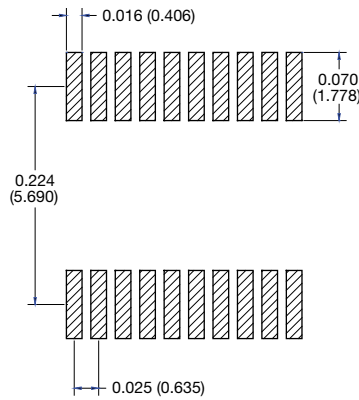

OSOP-24, VSSR-24, HD-CSO-24

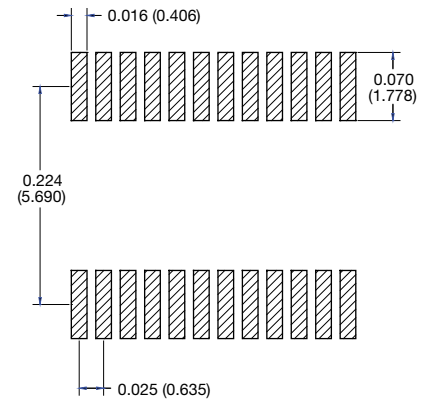

TSSOP MO-153

VTSR-16

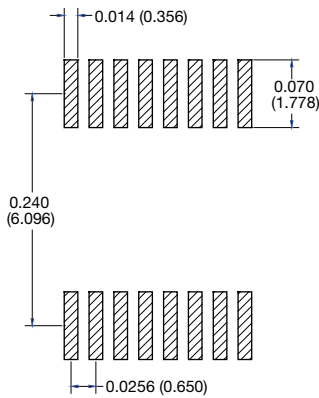

VTSR-20

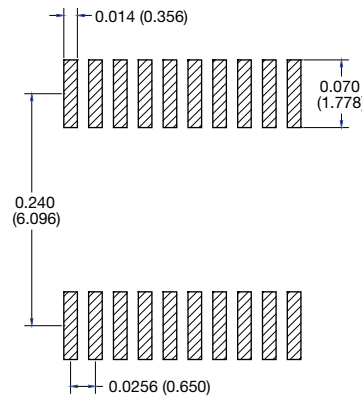

VTSR-24

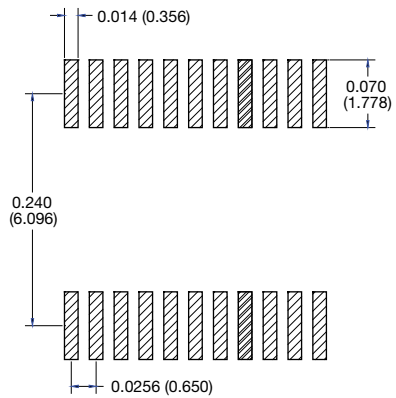

Surface Mount Leadless Networks (LCC Series)

16 Pin LCC

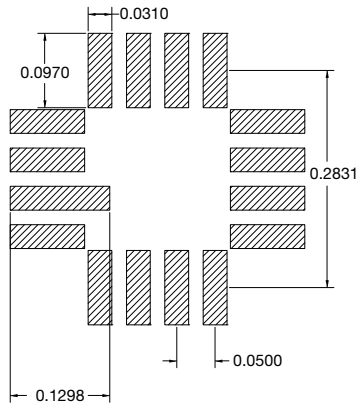

20 Pin LCC

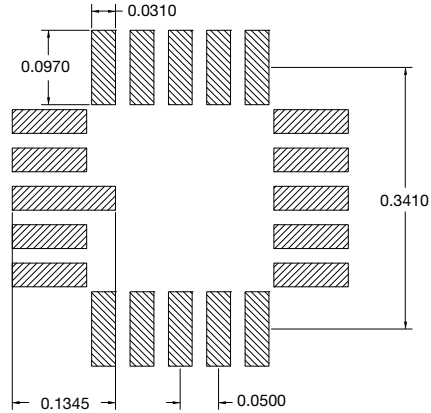

Surface Mount Leadless Networks (MPH Series)

4 Pin LCC

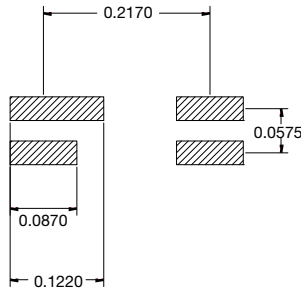

Surface Mount Leadless Packages DUAL/ QUAD Flat No Lead (DFN, QFN Series)

DFN MLP

DFN-8 4 x 5 mm Sq

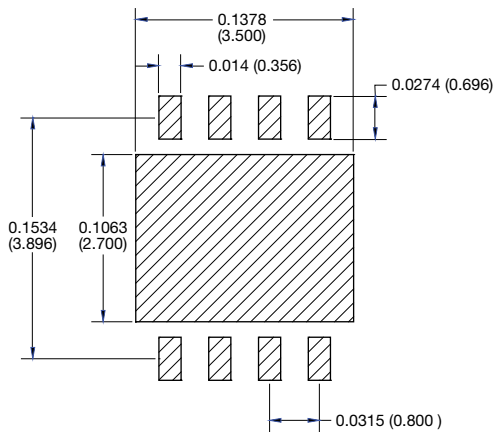

QFN MLP

QFN-20 5 x 5 mm Sq

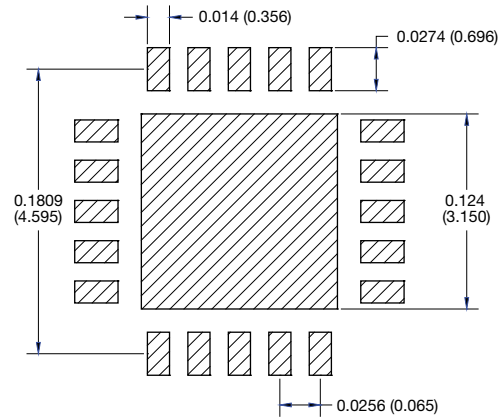

Surface Mount Leadless Resistor Arrays (PR Series)

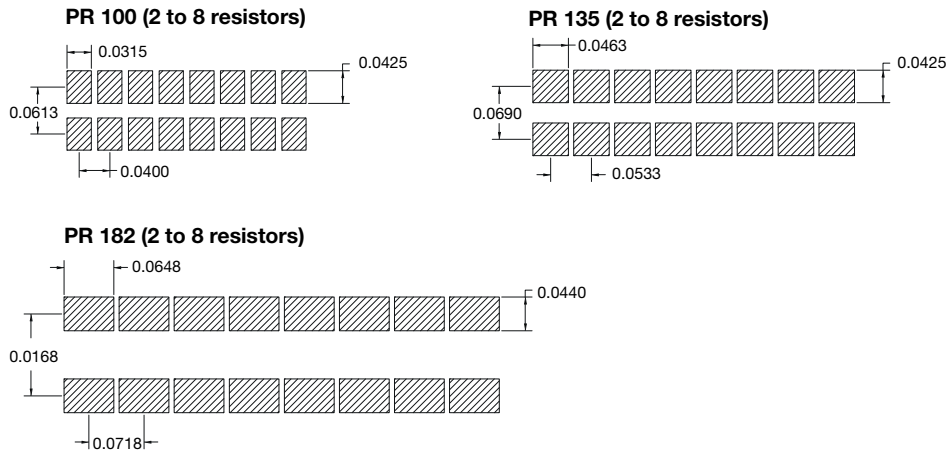

Note

- All dimensions in inches (mm)

Flatpack

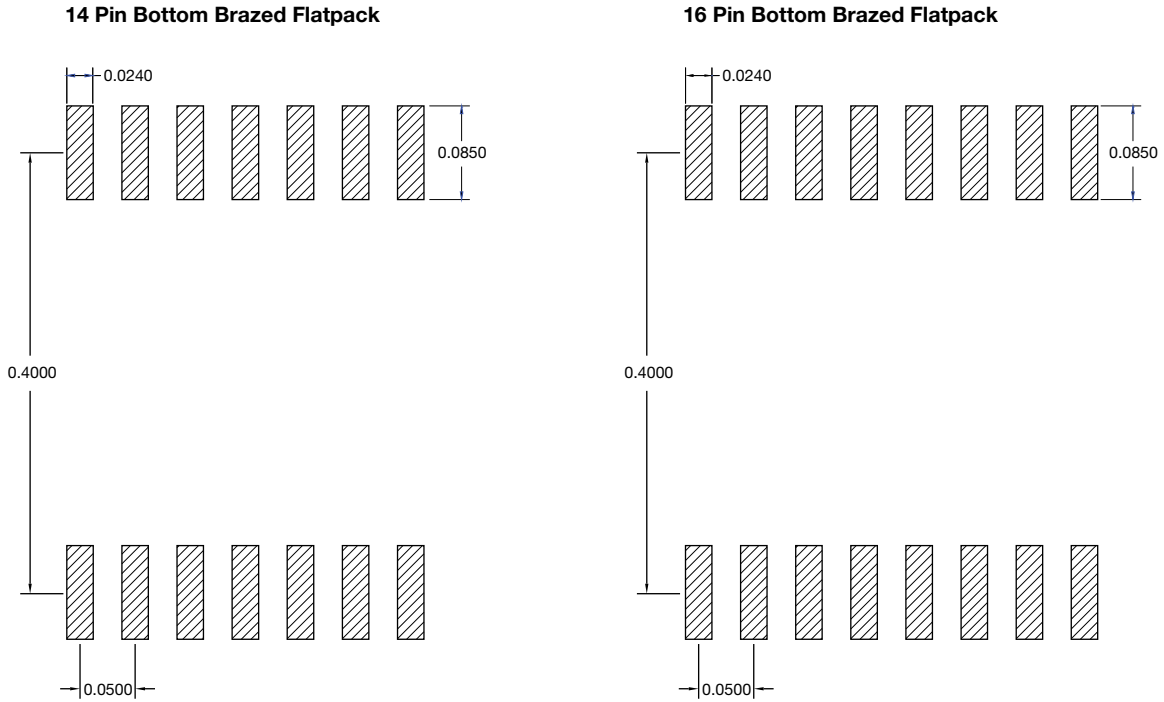



Disclaimer

ALL PRODUCT, PRODUCT SPECIFICATIONS AND DATA ARE SUBJECT TO CHANGE WITHOUT NOTICE TO IMPROVE RELIABILITY, FUNCTION OR DESIGN OR OTHERWISE.

Vishay Intertechnology, Inc., its affiliates, agents, and employees, and all persons acting on its or their behalf (collectively, "Vishay"), disclaim any and all liability for any errors, inaccuracies or incompleteness contained in any datasheet or in any other disclosure relating to any product.

Vishay makes no warranty, representation or guarantee regarding the suitability of the products for any particular purpose or the continuing production of any product. To the maximum extent permitted by applicable law, Vishay disclaims (i) any and all liability arising out of the application or use of any product, (ii) any and all liability, including without limitation special, consequential or incidental damages, and (iii) any and all implied warranties, including warranties of fitness for particular purpose, non-infringement and merchantability.

Statements regarding the suitability of products for certain types of applications are based on Vishay's knowledge of typical requirements that are often placed on Vishay products in generic applications. Such statements are not binding statements about the suitability of products for a particular application. It is the customer's responsibility to validate that a particular product with the properties described in the product specification is suitable for use in a particular application. Parameters provided in datasheets and / or specifications may vary in different applications and performance may vary over time. All operating parameters, including typical parameters, must be validated for each customer application by the customer's technical experts. Product specifications do not expand or otherwise modify Vishay's terms and conditions of purchase, including but not limited to the warranty expressed therein.

Except as expressly indicated in writing, Vishay products are not designed for use in medical, life-saving, or life-sustaining applications or for any other application in which the failure of the Vishay product could result in personal injury or death. Customers using or selling Vishay products not expressly indicated for use in such applications do so at their own risk. Please contact authorized Vishay personnel to obtain written terms and conditions regarding products designed for such applications.

No license, express or implied, by estoppel or otherwise, to any intellectual property rights is granted by this document or by any conduct of Vishay. Product names and markings noted herein may be trademarks of their respective owners.

X-ON Electronics

Largest Supplier of Electrical and Electronic Components

Click to view similar products for [Resistor Networks & Arrays](#) category:

Click to view products by [Vishay](#) manufacturer:

Other Similar products are found below :

[M8340105K1002FGD03](#) [M8340105K3301JCD03](#) [M8340106M2002GCD03](#) [M8340107K1471FGD03](#) [M8340107K2002GCD03](#)
[M8340107K2261FGD03](#) [M8340107M1501GGD03](#) [M8340108K1001FCD03](#) [M8340108K2402GGD03](#) [M8340108K3240FGD03](#)
[M8340108K4991FGD03](#) [M8340108K6192FGD03](#) [M8340109K2872FCD03](#) [M8340109MA010GHD03](#) [EXB-24N121JX](#) [EXB-24N330JX](#)
[EXB-24N470JX](#) [744C083101JTR](#) [EXB-U14360JX](#) [EXB-U18390JX](#) [744C083270JTR](#) [745C102472JP](#) [767161104G](#) [MDP1603100KGE04](#)
[770101223](#) [ACAS06S0830339P100](#) [ACAS06S0830343P100](#) [ACAS06S0830344P100](#) [RM2012A-102/104-PBVW10](#) [RM2012A-102503-](#)
[PBVW10](#) [8B472TR4](#) [268-15K](#) [ACAS06S0830341P100](#) [ACAS06S0830342P100](#) [ACAS06S0830345P100](#) [EXB-U14470JX](#) [EXB-U18330JX](#)
[266-10K](#) [M8340102K1051FBD04](#) [M8340105M1001JCD03](#) [M8340106K4701GGD03](#) [M8340107K1004GGD03](#) [M8340108K1000GGD03](#)
[M8340108K1202GGD03](#) [M8340108K3901GGD03](#) [M8340108K4992FGD03](#) [M8340108K5111FGD03](#) [M8340109K2202GCD03](#)
[RKC8BD104J](#) [DFNA100-1TS](#)