

PTC Thermistors Motor Start Packages



FEATURES

- Large diameter ceramic pellets for high starting current
- Various package sizes for optimum inrush current and switching time
- Rugged mechanical construction for reliable long life operation
- UL approved packages
- Plastic case mold UL 94 V-0 approved
- Adapted accessories for easy mounting
- Material categorization: for definitions of compliance please see www.vishay.com/doc?99912

RoHS
COMPLIANT

QUICK REFERENCE DATA		
PARAMETER	VALUE	UNIT
Resistance value at 25 °C	15 to 75	Ω
Tolerance on resistance value	± 30	%
Maximum current ratings	6 to 36	A _{RMS}
Switching temperature	110 to 120	°C
Switching times (typical)	0.25 to 1.0	s
Maximum voltage rating	410, 500	V _{RMS}
Operating temperature range	-10 to +80	°C
Storage temperature range	-25 to +105	°C

APPLICATIONS

- Single phase motor start assist in
 - Refrigerator systems
 - Air-conditioning systems
 - Heat-pumps
 - Small compressors

PTC MOTOR START SELECTION CHART								
VISHAY CERA-MITE PART NUMBER	CASE STYLE	R _{DYN} (Ω) ± 20 %	R ₂₅ (Ω) ± 30 %	SWITCH TIME t (s) at 230 V	CURRENT RATING (A _{RMS})	MAX. VOLTAGE RATING (V _{RMS})	COMPRESSOR RANGE (BTU 000)	COMPRESSOR RANGE (HP)
PTC305C20	C	25	35	0.25	10	410	10 to 28	0.75 to 2.0
PTC305C21	C	35	50	0.35	8	410	8 to 18	0.5 to 1.5
PTC305C22	C	50	75	0.50	6	410	5 to 12	0.25 to 1.0
PTC305C19	B	20	30	0.50	18	500	20 to 50	1.5 to 4.0
PTC305C12	B	25	40	0.60	15	500	18 to 42	1.5 to 3.5
PTC305C2	B	50	85	1.00	12	500	10 to 25	1.0 to 2.5
PTC305C9	A	10	15	0.50	36	500	28 to 68	3.0 to 7.0
PTC305C11	A	12.5	20	0.60	30	500	28 to 62	3.0 to 6.0
PTC305C1	A	25	42.5	1.00	24	500	14 to 36	1.5 to 3.5

PTC MOTOR START ACCESSORY SELECTION CHART	
ACCESSORY PART NUMBER	DESCRIPTION
PTCAUX36-520M	Round mounting bracket for case style C
PTCAUX36-520H	Round mounting bracket for case style A and B
PTCAUX7-36-5C	U-shaped mounting bracket for case style B
PTCAUX7-36-4C	U-shaped mounting bracket for case style A
PTCAUX50-1278	Jumper wire for case style A

ECONOMICAL SOLID STATE TORQUE ASSIST FOR HEAT PUMPS, ROOM AIR, COMMERCIAL AND RESIDENTIAL AIR CONDITIONING AND REFRIGERATION SYSTEMS

Positive Temperature Coefficient Thermistors (PTC) have been used for many years in millions of HVAC applications to provide starting torque assistance to Permanent Split Capacitor (PSC) single phase compressor motors.

Sizes are available to cover the full range of 120 V/240 V PSC compressor motors.

Safety Agency Recognition

Vishay Cera-Mite motor start PTC thermistors are recognized by Underwriter Laboratories file E97640 in accordance with standard for controllers and refrigeration components UL 873 or UL 60730; and Canadian Standard C22.2 No. 24. All packages and accessories are RoHS-compliant.

RELATIVE COMPARISON OF VARIOUS MOTOR STARTING METHODS

Three methods have historically been employed to generate starting torque for PSC motors. All are well-proven technologies and may be compared relative to one another based upon categories shown below.

The importance of each category is dependent upon the motor application and industry sector.

In general, if the PTC starter produces sufficient starting torque, it is considered the simplest and most economical choice.

Table 1

STARTING METHOD	MECHANICAL			ELECTRICAL					FINANCIAL		
	EASE OF WIRING	PANEL SPACE REQUIRED	SENSITIVE TO MOUNTING DIRECTION	ACCELERATION TORQUE PRODUCED	ACCELERATION (SWITCH) TIME	RESET TIME REQUIRED	EMI/RFI GENERATED	TECHNOLOGY	INVENTORY MIX REQUIRED	RELIABILITY	PURCHASED COST
PTC starter	Simple 2 wire	Lowest	No	Lowest	Fixed	3 min to 5 min	No	Solid State	Lowest	Highest	Lowest
Start cap with PTC acting as a current relay	Moderate 2 wire or 3 wire	Medium	Yes	Medium	Fixed	2 min to 5 min	No	Solid State	Medium	Medium	Medium
Start cap used with potential or current relay	Difficult 4 wire or 5 wire	Highest	Yes	Highest	Variable based on motor speed	None	Yes	Electro Mechanical	Highest	Lowest	Highest

SIMPLIFIED PTC STARTING DIAGRAM

Start Sequence

When starting the compressor, contactor (M) closes; the PTC, which is at low resistance, provides starting current to the motor's auxiliary winding. After time delay (t), the current passing through the PTC causes it to heat and "switch" to a very high resistance. At this point the motor is up to speed and the run capacitor (C_R) determines the current in the auxiliary winding. The PTC remains hot and at high resistance as long as voltage remains on the circuit. When contactor (M) opens, shutting off voltage to the compressor, the PTC cools to its initial low resistance and is again ready to provide torque assist on the next startup.

Fig T-2

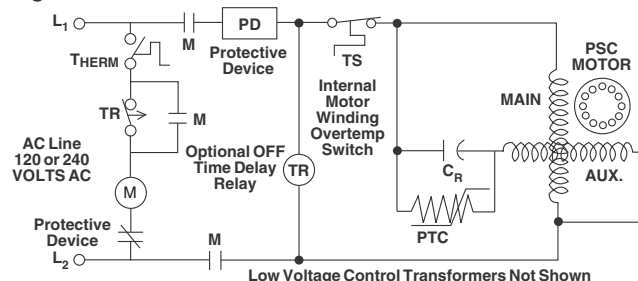

Restart

It is important to provide time between motor starts to allow the PTC to cool to near its initial temperature. This time is usually 3 min to 5 min and is determined by the thermostat (THERM) or separate time-delay relay (TR). Attempts to restart in less time may be successful depending on compressor equalization, line voltage, temperature, and other conditions. If the motor were to stall in a locked-rotor state, overload device (PD or TS) would open the line and a further time delay would occur until the motor overload is reset. Motor start PTCs are applied to compressors having means to equalize pressure during shutdown.

TYPICAL PTC CHARACTERISTICS AS A MOTOR START DEVICE

Fig T-3

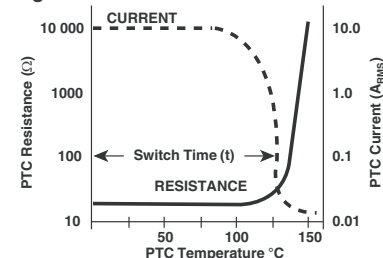

START AND ACCELERATION TORQUES SINGLE PHASE PSC HIGH EFFICIENCY COMPRESSORS

The use of a PTC start assist insures sufficient acceleration torque to overcome not only breakaway friction, but also parasitic asynchronous torques associated with the 5th and 7th motor harmonics or lamination slot harmonics.

Acceleration Time Considerations

The time to accelerate a rotating machine is:

$$\text{accelerating time (s)} = \frac{\text{RPM} \times \text{WK}^2 \text{ (lb ft}^2\text{)}}{\text{average torque (lb ft)} \times 308}$$

(average torque = curve B - curve A)

1. If (curve B - curve A) is zero or less, the motor may stall.
2. In calculating torque available from curve B, allowance should be made for cusps in the torque curve due to harmonics. The time needed to accelerate from rest to 1/2 speed is critical, as the average torque available in this region is limited. Select a PTC with sufficient switching time (t) to accelerate the compressor.
3. Scroll and rotary compressors may have less breakaway torque than shown.
4. A compressor with no equalization may require over 100 % starting torque and time as long as several seconds. PTC starters not recommended.

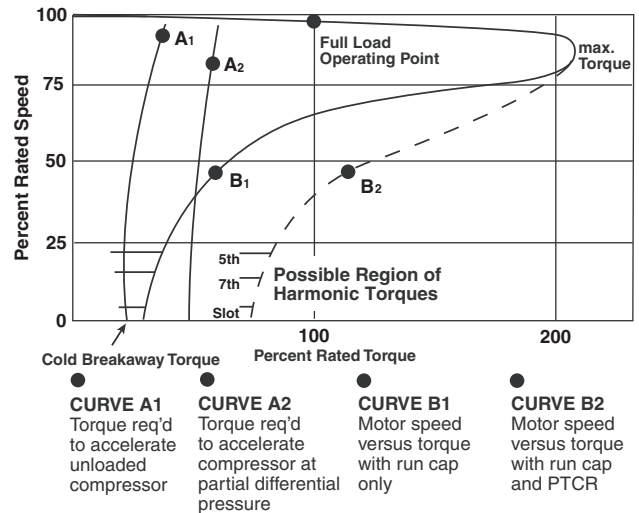

CONSIDERATIONS FOR CURRENT IN PTC APPROXIMATE EQUIVALENT CIRCUIT PSC MOTOR AT ZERO SPEED

$$I_L \text{ (run)} = \frac{\text{HP} \times 746}{V_M \times \text{pf} \times \text{eff}} \times I_L \text{ (start)} \approx I_L \text{ run}$$

For running conditions:

$$\text{If } V_{aux} = V_M \text{ then } I_M \text{ and } I_{aux} = \frac{I_L}{\sqrt{2}}$$

$$\text{If } (V_{aux} \neq V_M) \text{ then } I_{aux} = \frac{I_L}{\sqrt{2}} \times \frac{V_M}{V_{aux}} \text{ and } Z_{aux} = \frac{V_M}{I_{aux}}$$

For the greatest starting torque, PTC should be chosen to make:

$V_M \times I_M = V_{aux} \times I_{aux}$. In many cases the auxiliary Volt-Amperes are limited to about 50 % of the main winding Volt-Amperes to get 50 % to 70 % rated torque.

Then at start, with PTC in series:

$$Z'_{aux} = R_{PTC} + Z_{aux}$$

$$I_{Rstart} \text{ through PTC} = \frac{V_M}{Z_{aux}}$$

$$I_{Cstart} \text{ through Run Cap} = \frac{V_M}{X_C}; X_C = \frac{1}{2\pi fC} \Omega$$

$$I_{aux start} = I_{R start} + I_{C start}$$

If Z_{aux} is low impedance, less than 10 % of R_{PTC}

$$\text{then it can be ignored and } I_{PTC} \text{ at start} = \frac{V_M}{R_{PTCR}}$$

This closely approximates the condition for motors over 1/2 HP

Fig. T-5

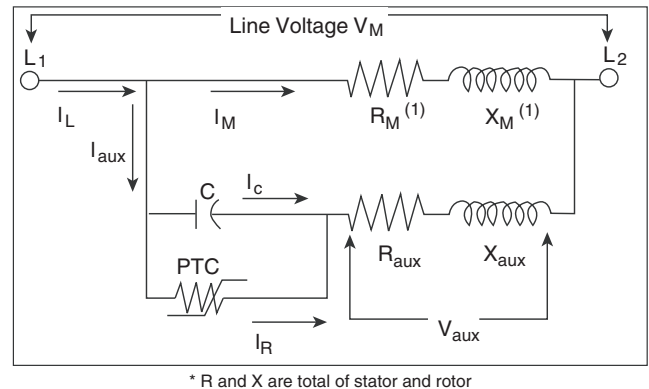

* R and X are total of stator and rotor

Fig T-6

Simplified voltage diagram of the PSC motor at operating speed.

Note

(1) I_A (auxiliary current) leads I_M (main current) by 80° to 90° when C (run capacitor) is chosen for balanced operation at 3/4 to full load. Line Power Factor = sine 2θ

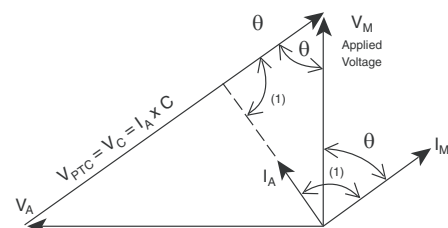

EFFECT OF PTC RESISTANCE ON STARTING TORQUE OF PSC MOTORS

Table 2

MOTOR HP (TABLE 4) (NOTE 7)	LOCKED ROTOR TORQUE WITH RUN CAP ONLY % RATED TORQUE (SEE A)	STARTING TORQUE WITH RUN CAP AND PTC (% RATED TORQUE) (SEE B) RESISTANCE (R _{DYN})				
		50 Ω	25 Ω	20 Ω	12.5 Ω	10 Ω
0.5	25 % to 35 %	70 % to 100 %	80 % to 100 %	NA	NA	NA
1	25 % to 35 %	50 % to 70 %	70 % to 100 %	NA	NA	NA
2	20 % to 30 %	40 % to 60 %	60 % to 90 %	70 % to 100 %	70 % to 100 %	80 % to 100 %
3.5	20 % to 30 %	NA	40 % to 60 %	50 % to 85 %	60 % to 90 %	70 % to 100 %
5	15 % to 25 %	NA	NA	40 % to 60 %	50 % to 75 %	60 % to 90 %
6.5	15 % to 25 %	NA	NA	NA	40 % to 70 %	50 % to 80 %

A. Rated torque is the torque at full speed rated load.

It is calculated as:

$$\text{Torque (lb - ft)} = \frac{\text{HP} \times 5250}{\text{RPM}}$$

The range shown includes both normal slip and high efficiency low slip motors. Starting torque varies as:

$$(\text{Line Voltage})^2$$

B. Figure T-4 shows effect of using PTC to increase starting torque. For reciprocating compressors, it is advised to choose a resistance value that gives at least 50 % rated torque at locked rotor. Scroll and rotary compressors may require less torque.

TYPICAL PTC CURRENT VS. TIME SHOWING DEFINITION OF RDYN AND SWITCH TIME (t)

Fig T-7

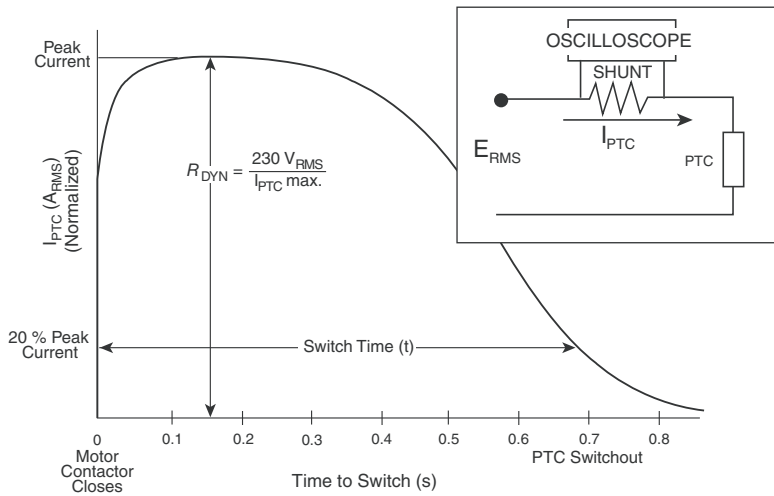

$$\text{Time (t)} \approx KM (130^\circ\text{C} - T_0) \frac{R_{DYN}}{V_{PTC}^2}$$

M = PTC mass (g)

T₀ = PTC temp at time 0

K = 0.75 J/g/°C

START CAPACITOR REPLACEMENT

Capacitor Starting Comparison

Some PSC motors have historically been started with a capacitor and relay. To deliver the same starting current as a start capacitor, a PTC resistance is available for approximately equal ohms. Table 3 can be used for conversion.

Even though the start current may be the same, the start torques may differ depending on the motor design. The PTC has a fixed time built in. The start capacitor will stay in the circuit until a relay switches it out. The longer time provided by the capacitor and relay may be needed on applications where equalization is not present or adequate reset time is not available.

STARTING CURRENT APPROXIMATION BASED ON

$$X_C = \frac{1}{2\pi fC}$$

Table 3

START CAPACITOR	PTC VALUE
50 μF	50 Ω
75 μF	37.5 Ω
100 μF	25 Ω
125 μF	20 Ω
200 μF	12.5 Ω
250 μF	10 Ω



PTC SELECTION

- Choosing the best PTC for an application is a simple matter. See Table 4 and Table 2. Vishay Cera-Mite PTCs are available in three case sizes (A, B, and C)
- Table 4 indicates the correct case size for the application. Table 2 shows how to choose the correct resistance value
- Using a device too small or resistance too high will give inadequate starting performance. An oversize device will

not harm the motor, but may not be optimum with regards to acceleration dynamics, or power dissipation

- The PTC is generally self protecting when applied within the voltage and current ratings
- All PTC305C Series starters and accessories are RoHS compliant

Table 4

PTC MOTOR START SELECTION CHART									
VISHAY CERA-MITE PART NUMBER (2)	CASE STYLE (2)	RESISTANCE (Ω) (3)		SWITCH TIME (4) (t) s AT 230 V	CURRENT RATING (5) (A _{RMS})	MAX. VOLTAGE RATING (6) (V _{RMS})	AVG. POWER DISSIPATION (7) (W)	COMPRESSOR RANGE (8)	
		R _{DYN} ± 20 %	R ₂₅ ± 30 %					BTU (000)	HP
PTC305C20 (1)	C	25	35	0.25	10	410	3.5	10 to 28	0.75 to 2.0
PTC305C21	C	35	50	0.35	8	410	3.5	8 to 18	0.5 to 1.5
PTC305C22 (1)	C	50	75	0.50	6	410	3.5	5 to 12	0.25 to 1.0
PTC305C19 (1)	B	20	30	0.50	18	500	7	20 to 50	1.5 to 4.0
PTC305C12 (1)	B	25	40	0.60	15	500	7	18 to 42	1.5 to 3.5
PTC305C2	B	50	85	1.00	12	500	7	10 to 25	1.0 to 2.5
PTC305C9 (1)	A	10	15	0.50	36	500	9	28 to 68	3.0 to 7.0
PTC305C11	A	12.5	20	0.60	30	500	9	28 to 62	3.0 to 6.0
PTC305C1 (1)	A	25	42.5	1.00	24	500	9	14 to 36	1.5 to 3.5

UL File E97640

Notes

- (1) Preferred values.
- (2) Part number is stamped on the device for UL recognition. The customer part number can also include 1 or 3 character alpha-numeric suffix to designate specific customer marking and accessory furnished. The suffix is not marked on the part. Certified outline drawing and complete part number will be furnished on request for specific applications.(Example: PTC305C19K01.) Mounting brackets and other accessories are to be ordered separately.
- (3) RDYN is nominal resistance equal to U/I when 230 V, 50 Hz/60 Hz is applied (see Fig T-7). This resistance determines current and maximum starting torque at the moment of application of voltage to the motor and can be measured with an oscilloscope. For receiving inspection or routine trouble shooting, the DC resistance at 25 °C (R₂₅) as measured with an ohmmeter is approximately 50 % greater. For example: PTC305C20 measured with an ohmmeter would be 35 Ω ± 30 % tolerance.
- (4) Resistance values are duplicated in several case sizes (i.e.: PTC305C20, C12, and C1) to provide longer switch time (t) and higher current ratings (see Fig. T-7). Larger parts may be needed for more difficult starting conditions (voltage or temperature) or may be used for accelerating fans against back pressure.
- (5) Maximum current in the PTC is determined by

$$\frac{\text{Maximum Line Voltage}}{\text{Minimum } R_{DYN}}$$

Motor auxiliary winding impedance is usually small compared to PTC resistance, and does not materially affect PTC current. Current in PTC is a percentage of the full motor inrush (locked rotor) current; usually 30 % to 50 % (see Fig T-5).

- (6) In application, the maximum voltage is the voltage that appears across the run capacitor at rated speed, high line, light load. This is not the applied line voltage (see Fig T-6). THESE DEVICES ARE INTENDED FOR APPLICATION ON 240 VOLT LINES OR SYSTEMS WITH MAXIMUM LINE VOLTAGE UP TO 265 V. The PTC305C20, 21 and 22 are also used on 120 V systems where the motor is designed to use same run capacitor and PTC as equivalent 230 V compressor.
- (7) This is the power used to keep the PTC switched in a high impedance state under full load running conditions at typical ambient temperature.
- (8) BTU and horsepower ranges are for reference only. PTC may be applied outside those ranges as long as maximum voltage and maximum current are not exceeded. Scroll and rotary compressors may require less starting assistance allowing use of smaller devices.

DIMENSIONS FOR PTC MOTOR START DEVICES in inches (millimeters)

• **PACKAGED MOTOR START PTCs ARE OFFERED IN THREE DIFFERENT CASE SIZES TO ACCOMMODATE THE RANGE OF PSC COMPRESSOR MOTORS SERVED**

Case Style C

Case Style C is a 2-terminal single pellet device with current carrying capacity up to 10 A. For proper mounting a bracket has to be ordered separately.

Fig T-8

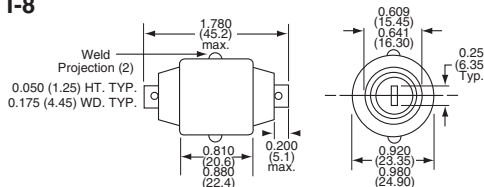

SAP ORDERING PART NUMBER	
CASE C	MOUNTING BRACKET
PTC305C20 PTC305C21 PTC305C22	PTCAUX36-520M (Round)

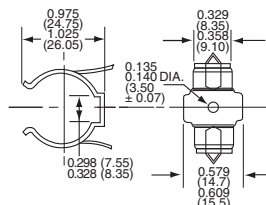

Round Bracket - Spring Steel Phosphate & Oil Finish. Accepts #6 Sheet Metal Screw

Case Style B

Case Style B is a 2-terminal single pellet unit with current carrying capacity up to 18 A. For proper mounting a U shaped or round bracket has to be ordered separately.

Fig T-9

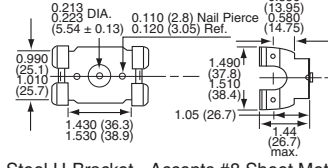
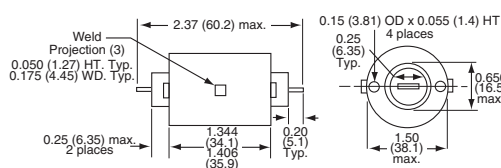

Steel U-Bracket - Accepts #8 Sheet Metal Screw

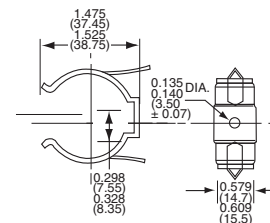

Round Bracket - Spring Steel Phosphate & Oil Finish. Accepts #6 Sheet Metal Screw

SAP ORDERING PART NUMBER	
CASE B	MOUNTING BRACKET
PTC305C2 PTC305C12 PTC305C19	PTCAUX7-36-5C (U-shaped) PTCAUX36-520H (Round)

Case Style A

Case Style A is a 3-terminal device that incorporates two pellets to be connected in parallel, resulting in lower resistance values and current carrying capacity up to 36 A. For proper mounting a U shaped or round bracket has to be ordered separately. To connect the two PTC pellets in parallel, a jumper wire can be ordered separately.

Fig T-10

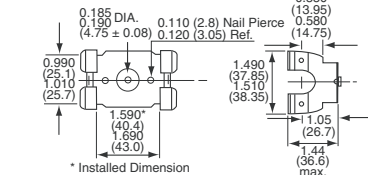
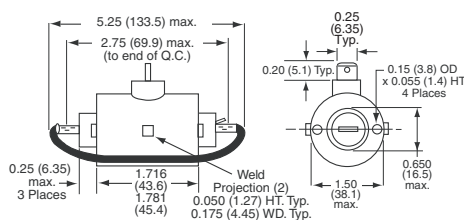

Steel U-Bracket - Accepts #8 Sheet Metal Screw

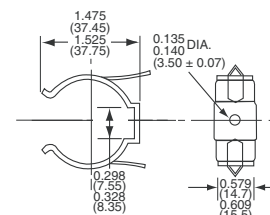

Round Bracket - Spring Steel Phosphate & Oil Finish. Accepts #6 Sheet Metal Screw

SAP ORDERING PART NUMBER		
CASE A	MOUNTING BRACKET	WIRE JUMPER
PTC305C1 PTC305C9 PTC305C11	PTCAUX7-36-4C (U-shaped) PTCAUX36-520H (Round)	PTCAUX50-1278 (9.75" (248) Long 105 °C wire)

OPERATING TEMPERATURE

Under normal operation, the ceramic pellet inside the case can reach a temperature of 150 °C. The plastic case material has been recognized by UL for operation up to this temperature. The actual temperature on the outside of the case will be approximately 100 °C while the motor is running. An appropriate mounting location and 105 °C, 600 V wiring are recommended.

CONNECTION DIAGRAMS

PTC Thermistors Motor Start units are connected directly across the PSC motor's "run" capacitor. Case style A is a 3-terminal device and uses an external jumper wire to connect the two internal pellets in parallel. A special "piggyback" terminal on the jumper wire provides for two connections on one side of the A-style case.

Fig T-11

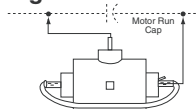

A Style
3-Terminal Case

Fig T-12

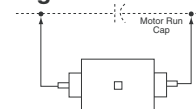

B & C Style
2-Terminal Case



VISHAY CERA-MITE MOTOR START FEATURES

ADVANCED CERAMIC ENGINEERING FOR HVAC

Vishay Cera-Mite's capability in large diameter ceramic pellets, unique formulations tailored to motor starting, and heavy duty electrode systems, have been developed and proven with the cooperation of HVAC industry experts over a period of more than 30 years.

INHERENT PERFORMANCE

Large diameter pellets make possible low resistance start devices needed to match torque requirements of high efficiency compressor motors.

Various package sizes offer selection of timing intervals, providing optimum switching time without dependence on sensing speed, counter EMF, or current.

RUGGED MECHANICAL CONSTRUCTION

Vishay Cera-Mite PTC cases are molded from a UL 94 V-0 high temperature, engineered plastic/glass composite.

Heavy duty aluminum contact plates and stainless steel force springs are scaled to the pellet sizes and current ratings to insure no internal arcing and to enhance quick reset time.

Unbreakable metal mounting brackets, sold separately, attach securely with a single screw. The "U" - brackets developed by Vishay Cera-Mite feature lower power consumption and greater reliability by maximizing case to ground thermal impedance.

SIMPLE AND ECONOMICAL

A solid state device requiring only 2 quick connect wires and one bracket screw to install. Compared to the alternative start capacitor and relay, PTC start devices save several wires, occupy less panel space, mount more easily, and cost less.

OUTSTANDING RELIABILITY

Over a twenty year period, with an installed base of millions of Vishay Cera-Mite PTC start devices, experience has demonstrated reliability at 1.0 FIT or less. Users have benefited from very low warranty expense.

RESTART CONSIDERATIONS

A properly sized PTC will provide adequate starting current and starting time with a cool down time of 3 min to 5 min, coordinating perfectly with standard "off delay" equalization timers restart characteristics of the three case sizes are shown.

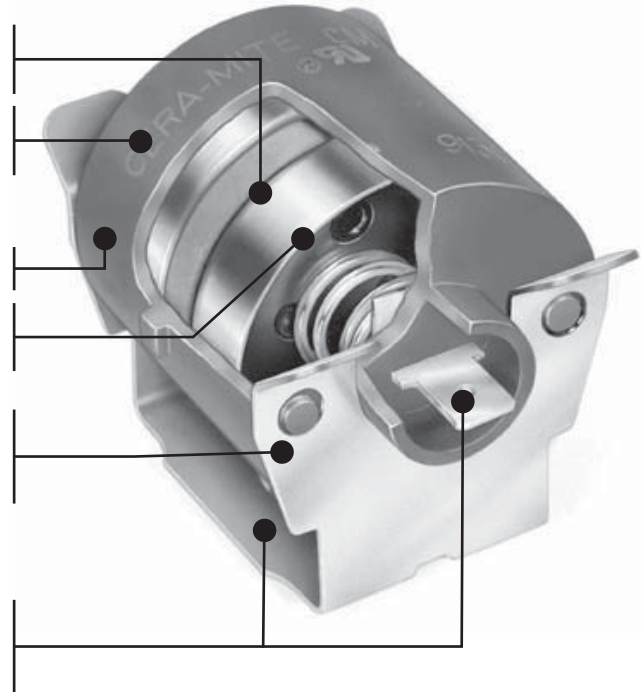
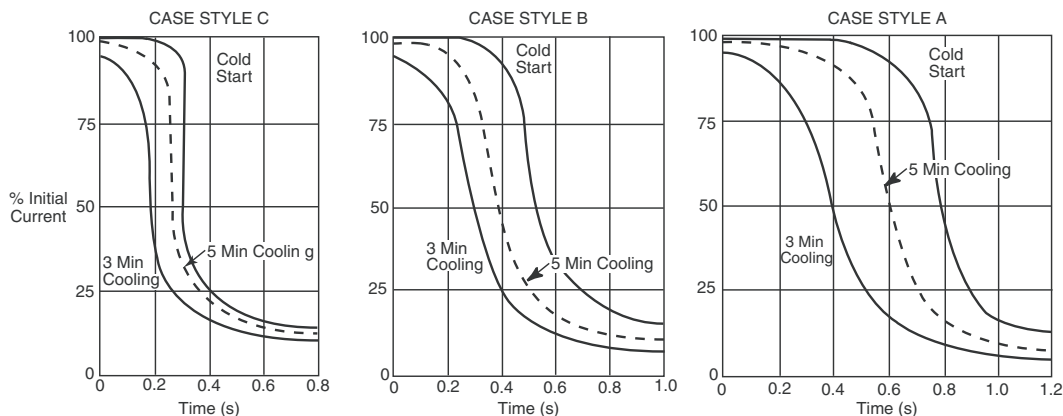

Fig T-13

Fig T-14

Fig T-15





Disclaimer

ALL PRODUCT, PRODUCT SPECIFICATIONS AND DATA ARE SUBJECT TO CHANGE WITHOUT NOTICE TO IMPROVE RELIABILITY, FUNCTION OR DESIGN OR OTHERWISE.

Vishay Intertechnology, Inc., its affiliates, agents, and employees, and all persons acting on its or their behalf (collectively, "Vishay"), disclaim any and all liability for any errors, inaccuracies or incompleteness contained in any datasheet or in any other disclosure relating to any product.

Vishay makes no warranty, representation or guarantee regarding the suitability of the products for any particular purpose or the continuing production of any product. To the maximum extent permitted by applicable law, Vishay disclaims (i) any and all liability arising out of the application or use of any product, (ii) any and all liability, including without limitation special, consequential or incidental damages, and (iii) any and all implied warranties, including warranties of fitness for particular purpose, non-infringement and merchantability.

Statements regarding the suitability of products for certain types of applications are based on Vishay's knowledge of typical requirements that are often placed on Vishay products in generic applications. Such statements are not binding statements about the suitability of products for a particular application. It is the customer's responsibility to validate that a particular product with the properties described in the product specification is suitable for use in a particular application. Parameters provided in datasheets and / or specifications may vary in different applications and performance may vary over time. All operating parameters, including typical parameters, must be validated for each customer application by the customer's technical experts. Product specifications do not expand or otherwise modify Vishay's terms and conditions of purchase, including but not limited to the warranty expressed therein.

Except as expressly indicated in writing, Vishay products are not designed for use in medical, life-saving, or life-sustaining applications or for any other application in which the failure of the Vishay product could result in personal injury or death. Customers using or selling Vishay products not expressly indicated for use in such applications do so at their own risk. Please contact authorized Vishay personnel to obtain written terms and conditions regarding products designed for such applications.

No license, express or implied, by estoppel or otherwise, to any intellectual property rights is granted by this document or by any conduct of Vishay. Product names and markings noted herein may be trademarks of their respective owners.

X-ON Electronics

Largest Supplier of Electrical and Electronic Components

Click to view similar products for [vishay](#) manufacturer:

Other Similar products are found below :

[RER75F2260PCSL](#) [M39006/22-0577H](#) [Y00892K49000BR13L](#) [VSKT250-16PBF](#) [M8340109M6801GGD03](#) [RER60F2430RC02](#)
[NTCALUG01A103F291L](#) [ITU1341SM3](#) [VS-MBRB1545CTPBF](#) [1KAB100E](#) [1KAB20E](#) [CP0005150R0JE1490](#) [S472M69Z5UR84K0R](#)
[MKP1848C65090JY5L](#) [562R5GAD47RR](#) [CRCW1210360RFKEA](#) [VSMF4720-GS08](#) [TSOP34438SS1V](#) [CRCW04024021FRT7](#) [001789X](#)
[LTO050FR0500JTE3](#) [CRCW08054K00FKTA](#) [LVR10R0200FE03](#) [009923A](#) [CRCW2010331JR02](#) [CS6600552K000B8768](#)
[CSC07A0110K0GPA](#) [M34C156K100BZSS](#) [M39003/01-2289](#) [M39003/01-2784](#) [M39006/25-0133](#) [M39006/25-0228](#) [M64W101KB40](#)
[M64Z501KB40](#) [CW001R5000JS73](#) [CW0055R000JE12](#) [CW0056K800JB12](#) [CW0106K000JE73](#) [672D826H075EK5C](#) [CWR06JC105KC](#)
[CWR06NC475JC](#) [MAL219699001E3](#) [MCRL007035R00JHB00](#) [92MT80KPBF](#) [PTF56100K00QYEK](#) [PTN0805H1502BBTR1K](#)
[RCWL1210R130JNEA](#) [RH00515R80FC02](#) [RH005220R0FE02](#) [RH005330R0FC02](#)