

## Commercial Thin Film Chip Resistor, Surface Mount Chip

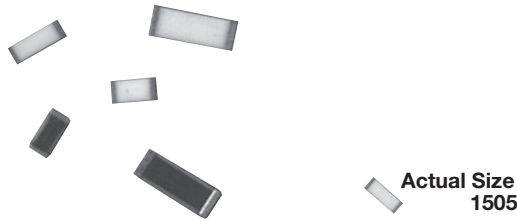

These chip resistors are available in both “top side” and “wraparound” termination styles in a variety of sizes. They incorporate self passivated, enhanced Tantalum Nitride films, to give superior performance on moisture resistance, voltage coefficient, power handling and resistance stability. The terminations consist of an adhesion layer, a leach resistant nickel barrier, and solder coating. This product will out-perform all requirements of characteristic E of MIL-PRF-55342.

### CONSTRUCTION

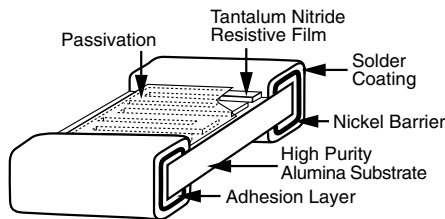

### FEATURES

- Moisture resistant
- High purity alumina substrate
- Non-standard values available
- Will pass +85 °C, 85 % relative humidity and 10 % rated power
- 100 % visual inspected per MIL-PRF-55342
- Non-inductive
- Very low noise and voltage coefficient (< -30 dB)
- Laser-trimmed tolerances to  $\pm 0.05$  %
- Wraparound resistance less than 10 m $\Omega$
- Epoxy bondable termination available
- Sulfur resistant (per ASTM B809-95 humid vapor test)
- Material categorization: for definitions of compliance please see [www.vishay.com/doc?99912](http://www.vishay.com/doc?99912)

**RoHS\***  
Available

**HALOGEN  
FREE**  
Available

**GREEN  
(5-2008)**  
Available

### Note

\* This datasheet provides information about parts that are RoHS-compliant and / or parts that are non-RoHS-compliant. For example, parts with lead (Pb) terminations are not RoHS-compliant. Please see the information / tables in this datasheet for details.

### TYPICAL PERFORMANCE

	ABSOLUTE
TCR	10
TOL.	0.05

### STANDARD ELECTRICAL SPECIFICATIONS

TEST	SPECIFICATIONS	CONDITIONS
Material	Tantalum nitride	-
Resistance Range	1.0 $\Omega$ to 3 M $\Omega$	-
TCR: Absolute	$\pm 10$ ppm/ $^{\circ}$ C to $\pm 100$ ppm/ $^{\circ}$ C	-55 $^{\circ}$ C to +125 $^{\circ}$ C
Tolerance: Absolute	$\pm 0.05$ % to $\pm 5$ %	+25 $^{\circ}$ C
Stability: Absolute	$\Delta R \pm 0.03$ %	2000 h at 70 $^{\circ}$ C
Stability: Ratio	-	-
Voltage Coefficient	0.1 ppm/V	-
Working Voltage	75 V to 200 V	-
Operating Temperature Range	-55 $^{\circ}$ C to +155 $^{\circ}$ C	-
Storage Temperature Range	-55 $^{\circ}$ C to +155 $^{\circ}$ C	-
Noise	< -30 dB	-
Shelf Life Stability: Absolute	-	-

### COMPONENT RATINGS

CASE SIZE <sup>(1)</sup>	POWER RATING (mW)	WORKING VOLTAGE (V)	RESISTANCE RANGE ( $\Omega$ )
0402	50	75	1.5 to 51.1K
0502	100	75	1.5 to 65K
0505	150	75	10 to 130K
0603	150	75	1.5 to 130K
0705	200	100	1.0 to 310K
0805	200	100	1.0 to 310K
1005	250	100	1.5 to 360K
1010	500	150	1.0 to 600K
1206	400	200	1.5 to 1M
1505	400	150	1.25 to 1M
2208	750	150	2.0 to 1.75M
2010	800	200	1.0 to 2M
2512 <sup>(2)</sup>	2000	200	1.5 to 3M

### Notes

<sup>(1)</sup> 0705 and 0805 are the same (only use 0805 when ordering)

<sup>(2)</sup> Reference environmental tests table for short time overload test parameters.

DIMENSIONS in inches					
CASE SIZE	L	W	T	D	E
0402	0.042 ± 0.008	0.022 ± 0.005	0.012 to 0.033	0.010 ± 0.005	0.010 ± 0.005
0502	0.055 ± 0.006	0.025 ± 0.005	0.012 to 0.033	0.010 ± 0.005	0.015 ± 0.005
0505	0.055 ± 0.006	0.050 ± 0.005	0.012 to 0.033	0.010 ± 0.005	0.015 ± 0.005
0603	0.064 ± 0.006	0.032 ± 0.005	0.020 max.	0.012 ± 0.005	0.015 ± 0.005
0705, 0805 <sup>(1)</sup>	0.080 ± 0.006	0.050 ± 0.005	0.015 to 0.033	0.016 ± 0.008	0.015 ± 0.005
1005	0.105 ± 0.007	0.050 ± 0.005	0.015 to 0.033	0.015 ± 0.005	0.015 ± 0.005
1010	0.105 ± 0.007	0.100 ± 0.005	0.015 to 0.033	0.015 ± 0.005	0.015 ± 0.005
1206	0.126 ± 0.008	0.063 ± 0.005	0.015 to 0.033	0.020 ± 0.005 / - 0.010	0.020 ± 0.005 / - 0.010
1505	0.155 ± 0.007	0.050 ± 0.005	0.015 to 0.033	0.015 ± 0.005	0.015 ± 0.005
2010	0.209 ± 0.009	0.098 ± 0.005	0.015 to 0.033	0.020 ± 0.005	0.020 ± 0.005
2208	0.230 ± 0.007	0.075 ± 0.005	0.015 to 0.033	0.020 ± 0.005	0.020 ± 0.005
2512	0.259 ± 0.009	0.124 ± 0.005	0.015 to 0.033	0.020 ± 0.005	0.020 ± 0.005

**Note**

<sup>(1)</sup> 0705 and 0805 are the same (only use 0805 when ordering)

ENVIRONMENTAL TESTS (Vishay Performance vs. MIL-PRF-55342 Requirements)		
ENVIRONMENTAL TEST	LIMITS MIL-PRF-55342 CHARACTERISTIC "E"	TYPICAL VISHAY PERFORMANCE
Resistance Temperature Characteristic	± 25 ppm/°C	± 15 ppm/°C
Max. Ambient Temp. at Rated Wattage	+70 °C	+70 °C
Max. Ambient Temp. at Power Derating	+150 °C	+150 °C
Thermal Shock $\Delta R$	± 0.1 %	± 0.040 %
Low Temperature Operation $\Delta R$	± 0.1 %	± 0.001 %
Short Time Overload <sup>(1)</sup> $\Delta R$	± 0.10 %	± 0.002 %
High Temperature Exposure $\Delta R$	± 0.1 %	± 0.04 %
Resistance to Soldering Heat $\Delta R$	± 0.2 %	± 0.008 %
Moisture Resistance $\Delta R$	± 0.2 %	± 0.004 %
Life +70 °C at 1000 h $\Delta R$	± 0.50 %	± 0.02 %
Insulation Resistance	10 000 $\Omega$ minimum	> 100 000 M $\Omega$

**Note**

<sup>(1)</sup> 2512 short time overload test is based on 1 W power level below critical value of 20 k $\Omega$ .

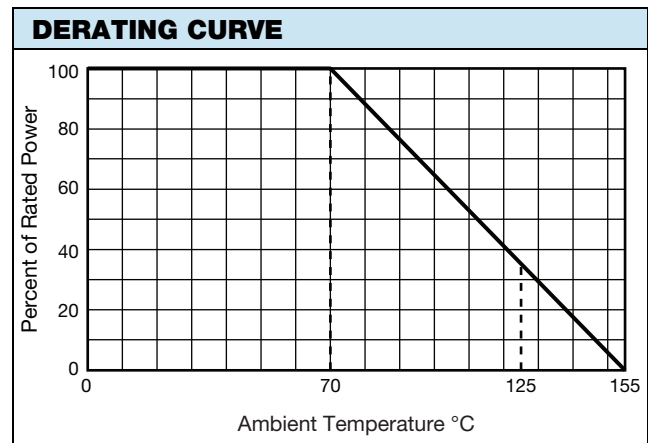
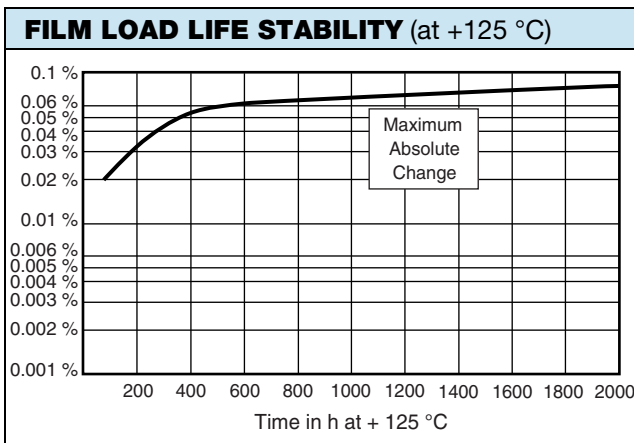

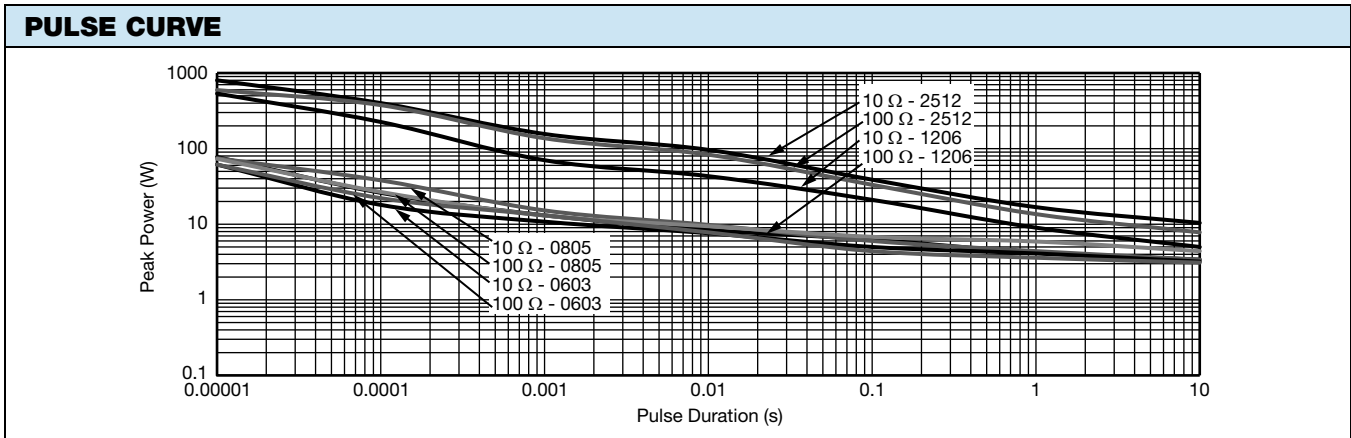

### GLOBAL PART NUMBER INFORMATION

New Global Part Numbering: PTN1206E1002BBT1

**P** **T** **N** **1** **2** **0** **6** **E** **1** **0** **0** **2** **B** **B** **T** **1**

GLOBAL MODEL	CASE SIZE	TCR CHARACTERISTIC	RESISTANCE	TOLERANCE	TERMINATION	PACKAGING
PTN	0402 0502 0505 0603 0805 1005 1010 1206 1505 2208 2010 2512	D = ± 15 ppm/°C <sup>(1)</sup> E = ± 25 ppm/°C <sup>(2)</sup> H = ± 50 ppm/°C <sup>(2)</sup> K = ± 100 ppm/°C L = ± 200 ppm/°C Y = ± 10 ppm/°C <sup>(3)</sup>	The first 3 digits are significant figures and the last digit specifies the number of zeros to follow. "R" designates the decimal point.  Example: 10R0 = 10 Ω 1000 = 100 Ω 1001 = 1 kΩ	A = ± 0.05 % <sup>(2)</sup> B = ± 0.1 % D = ± 0.5 % F = ± 1 % G = ± 2 % J = ± 5 %	B = wraparound Sn/Pb solder Sn63 w/nickel barrier G = wraparound Au over Ni (gold) termination epoxy bondable RoHS-compliant - e4 S = wraparound electroplated 100 % pure matte tin RoHS-compliant - e3	<b>BS</b> = BULK 100 min., 1 mult <b>W0</b> = WAFFLE 100 min., 100 mult <b>WS</b> = WAFFLE 100 min., 1 mult <b>W1</b> = 100 min., 1 mult (item single lot date code) <b>WP</b> = 100 min., 1 mult (package unit single lot date code)  <b>TAPE AND REEL</b> <b>T0</b> = 100 min., 100 mult <b>T1</b> = 1000 min., 1000 mult <sup>(4)</sup> <b>T3</b> = 300 min., 300 mult <b>T5</b> = 500 min., 500 mult <b>TF</b> = Full reel <b>TS</b> = 100 min., 1 mult <b>TI</b> = 100 min., 1 mult (item single lot date code) <b>TP</b> = 100 min., 1 mult (package unit single lot date code)

Historical Part Number example: PTN0805H8801BBT (for reference purposes only)

PTN	0805	H	8801	B	B	T
STYLE	CASE SIZE	TCR CHARACTERISTIC	OHMIC VALUE	TOLERANCE	TERMINATION	PACKAGING

**Notes**

- (1) Not available below 50 Ω.
- (2) Not available below 10 Ω.
- (3) ≥ 1 kΩ
- (4) Preferred packaging code.

RESISTANCE	TCR (ppm/°C)	TOLERANCE (%)
10 Ω to 3 MΩ	25, 50, 100, 200	0.1, 0.5, 1, 2, 5
5 Ω to 10 Ω	100, 200	1, 2, 5
1.0 Ω to 5 Ω	200	1, 2, 5



### Vishay Dale Thin Film Land Patterns

#### 1. Scope

This technical note provides sample land patterns for Vishay Dale Thin Film SMT resistive products. The following drawings are based on IPC-SM-782 Surface Mount Design and Land Pattern Standard. These drawings are for reference only Vishay Thin Film recommends that the user contacts their PC board supplier for actual land patterns required. The pads are intended for lead (Pb)-free and tin / lead solder types.

#### 2. Product Series

Thin Film Surface Mount Chip Resistors (FC, L, P, PTN, PLT, PLTT, PLTU, PAT, PATT, PNM, M/D55342 QPL Series)

**0402 Land Pattern**

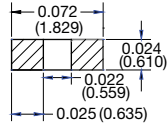

**0502 Land Pattern**

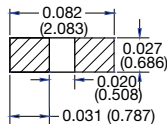

**0505 Land Pattern**

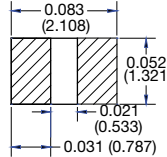

**0603 Land Pattern**

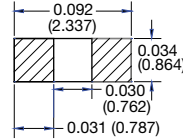

**0705 Land Pattern**

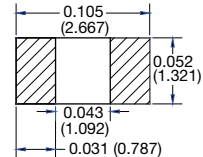

**1005 Land Pattern**

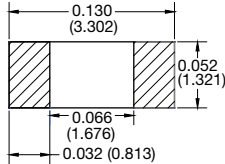

**1010 Land Pattern**

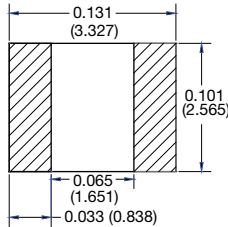

**1206 Land Pattern**

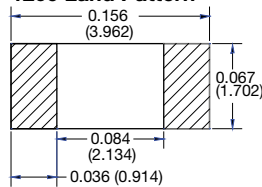

**1505 Land Pattern**

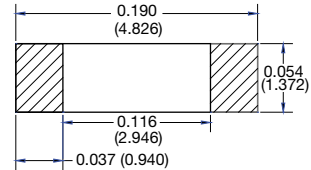

**2010 Land Pattern**

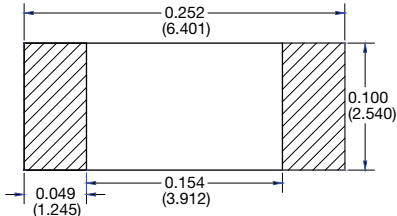

**2208 Land Pattern**

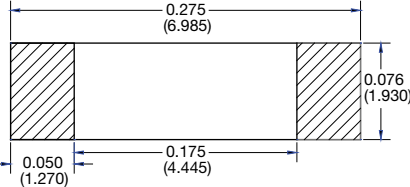

**2512 Land Pattern**

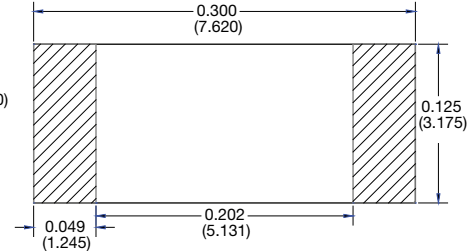



### Thin Film Surface Mount Chip Resistors (PHP, PCAN Series)

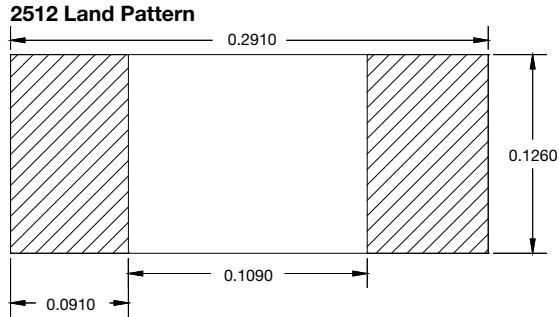
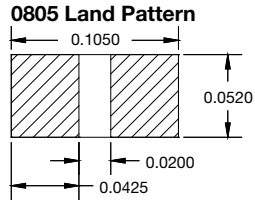
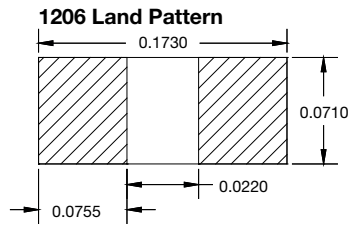
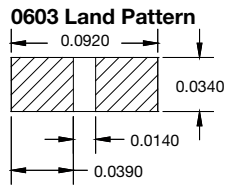

### Thin Film Surface Mount Chip Resistors Long Axis Termination (L Series)

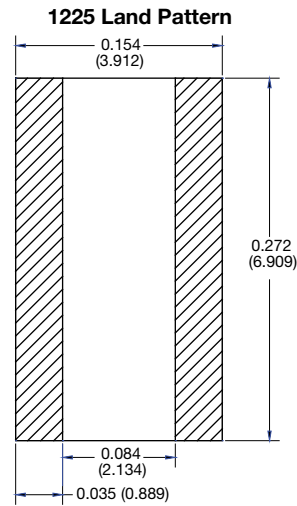
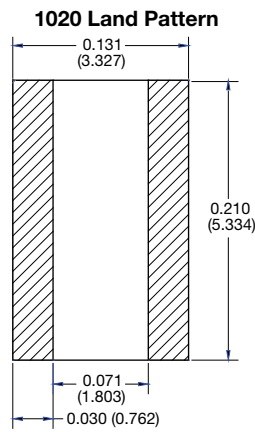
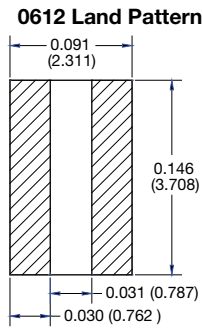
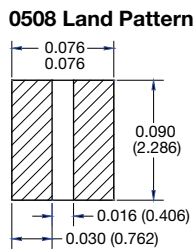



### Surface Mount Networks (MPM, MP3, MP4 Series)

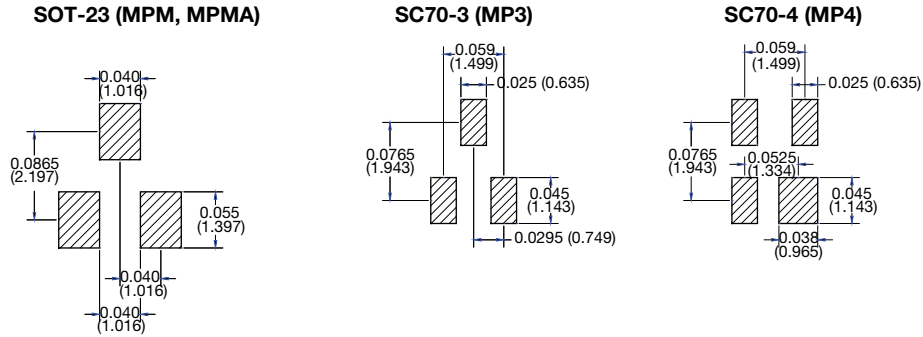

### Surface Mount Networks SOIC Narrow Body 150 mils (ORN, CSO, MOMC, HTRN, AORN, MORN Series)

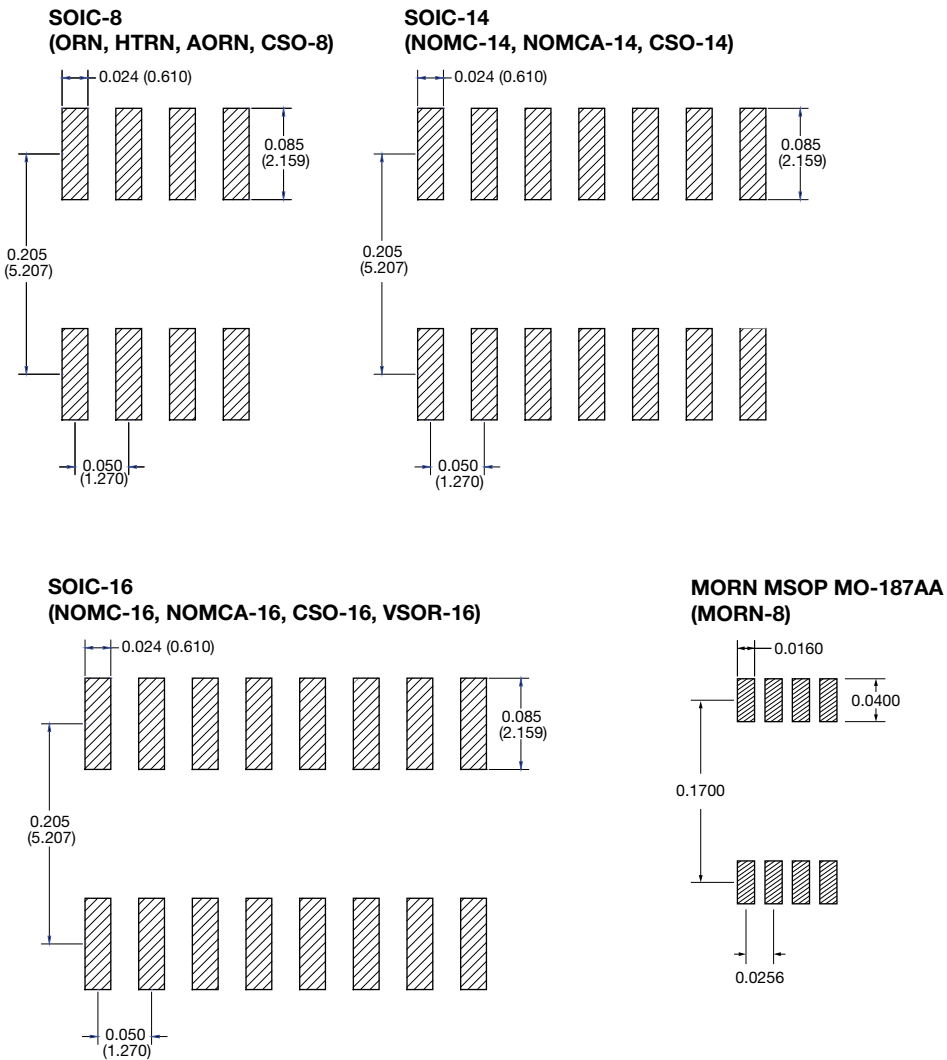



### Surface Mount Networks SOIC Medium Body 220 mils (TOMC Series)

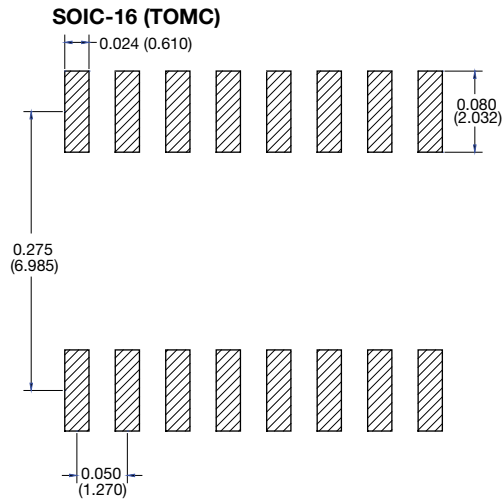

### Surface Mount Networks SOIC Wide Body 300 mils (WOMC Series)

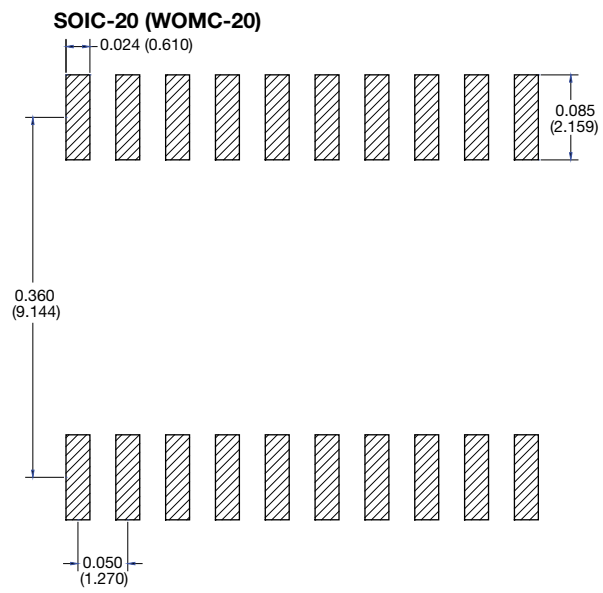
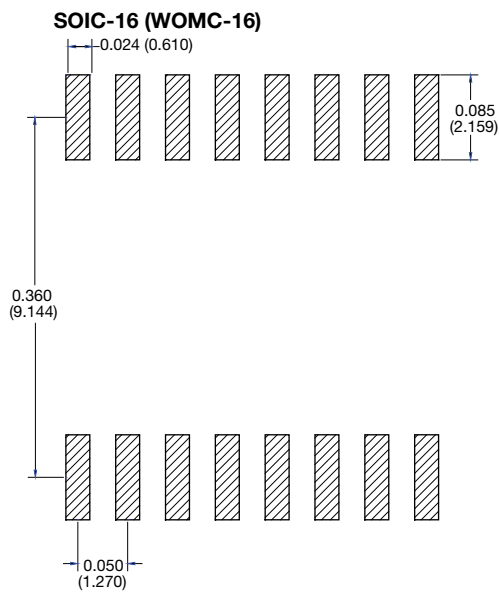



### Surface Mount Networks High Density SSOP, TSOP (VSSR, VTSR Series)

#### SSOP MO-137

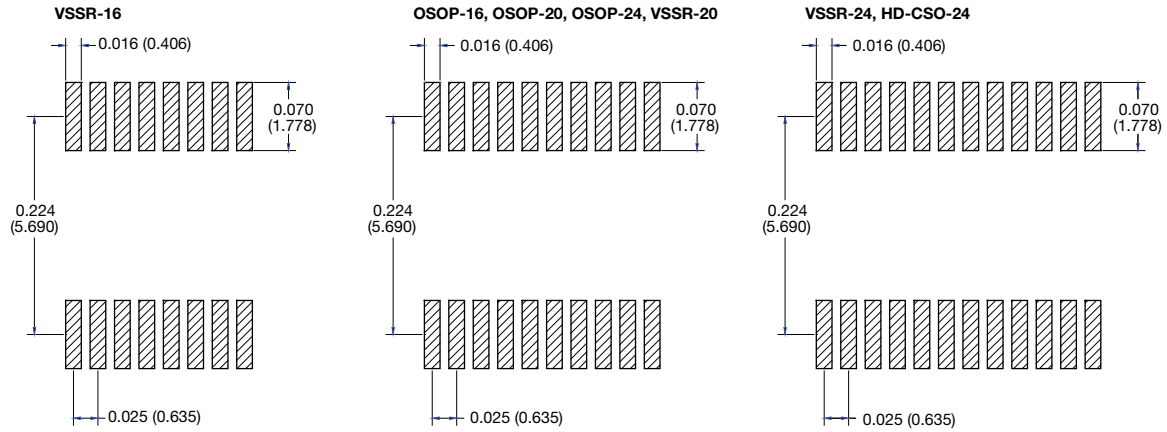

#### TSSOP MO-153

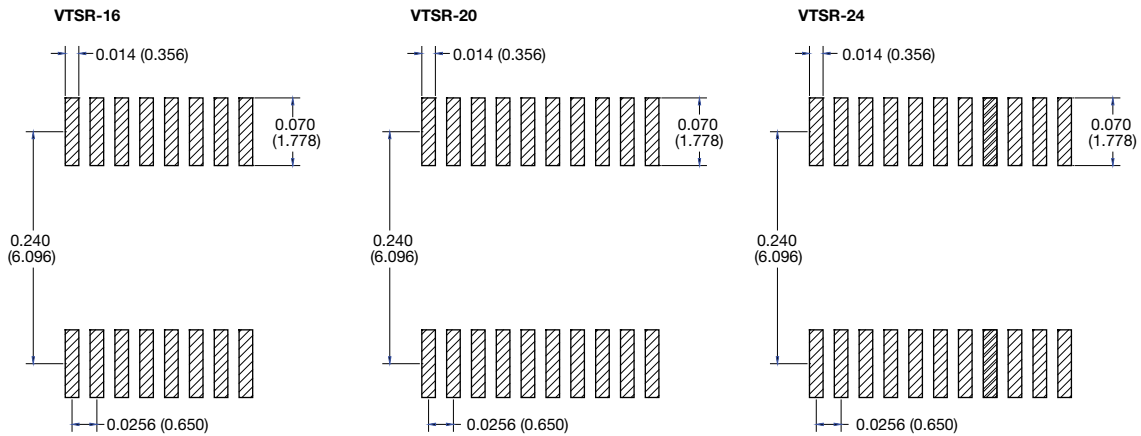





### Surface Mount Leadless Networks (LCC Series)

#### 16 Pin LCC

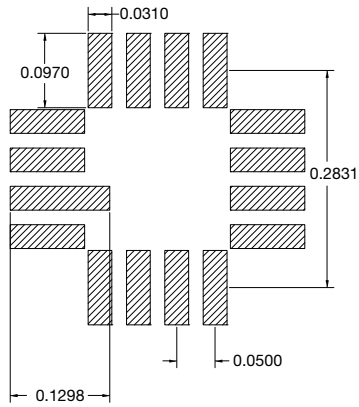

#### 20 Pin LCC

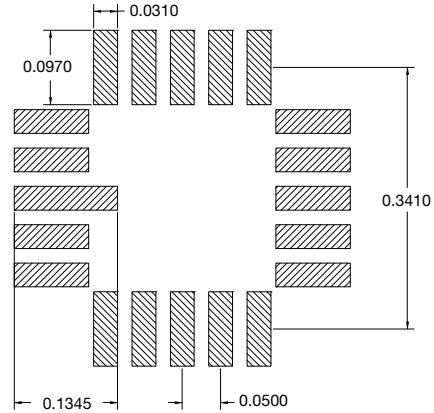

### Surface Mount Leadless Networks (MPH Series)

#### 4 Pin LCC

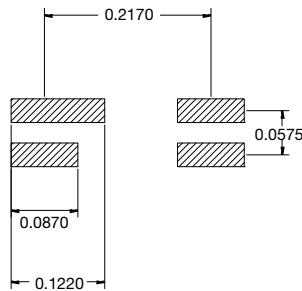

### Surface Mount Leadless Packages DUAL/ QUAD Flat No Lead (DFN, QFN Series)

#### DFN MLP

##### DFN-8 4 x 5 mm Sq

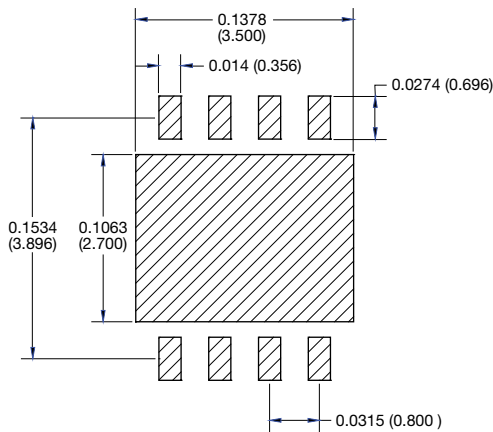

#### QFN MLP

##### QFN-20 5 x 5 mm Sq

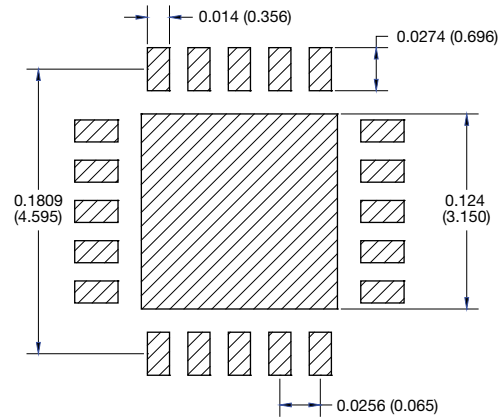



### Surface Mount Leadless Resistor Arrays (PR Series)

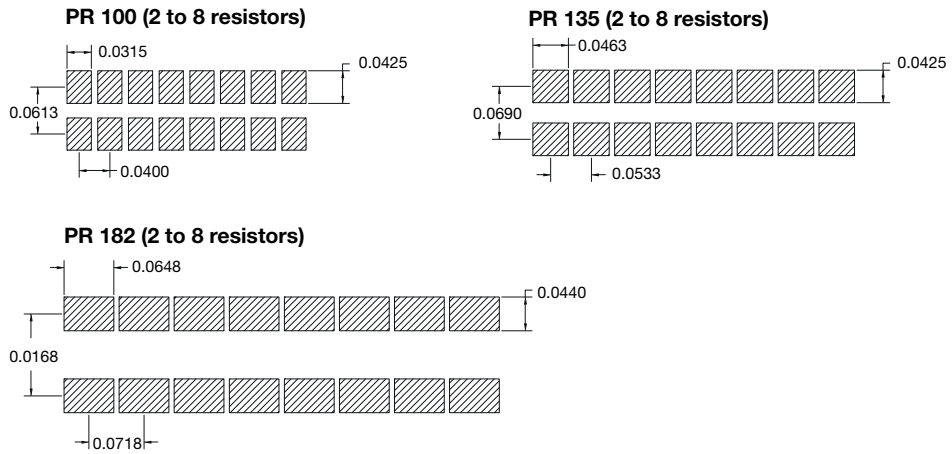

#### Note

- All dimensions in inches (mm)

### Flatpack

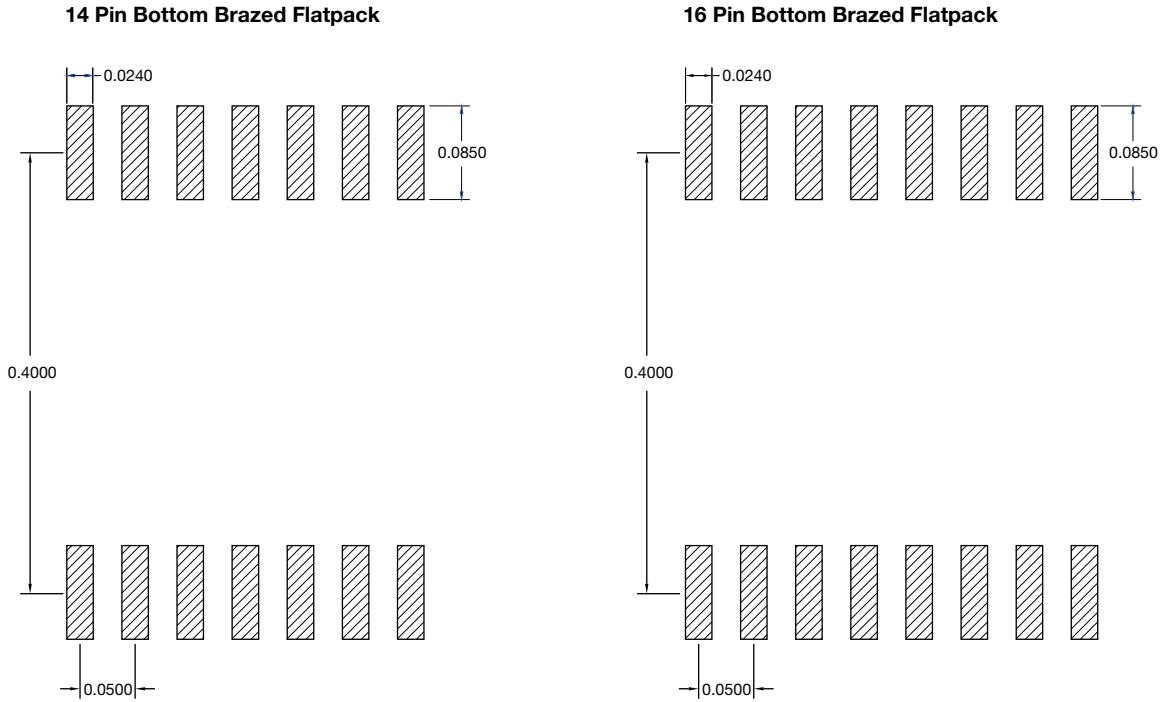



## **Disclaimer**

ALL PRODUCT, PRODUCT SPECIFICATIONS AND DATA ARE SUBJECT TO CHANGE WITHOUT NOTICE TO IMPROVE RELIABILITY, FUNCTION OR DESIGN OR OTHERWISE.

Vishay Intertechnology, Inc., its affiliates, agents, and employees, and all persons acting on its or their behalf (collectively, "Vishay"), disclaim any and all liability for any errors, inaccuracies or incompleteness contained in any datasheet or in any other disclosure relating to any product.

Vishay makes no warranty, representation or guarantee regarding the suitability of the products for any particular purpose or the continuing production of any product. To the maximum extent permitted by applicable law, Vishay disclaims (i) any and all liability arising out of the application or use of any product, (ii) any and all liability, including without limitation special, consequential or incidental damages, and (iii) any and all implied warranties, including warranties of fitness for particular purpose, non-infringement and merchantability.

Statements regarding the suitability of products for certain types of applications are based on Vishay's knowledge of typical requirements that are often placed on Vishay products in generic applications. Such statements are not binding statements about the suitability of products for a particular application. It is the customer's responsibility to validate that a particular product with the properties described in the product specification is suitable for use in a particular application. Parameters provided in datasheets and / or specifications may vary in different applications and performance may vary over time. All operating parameters, including typical parameters, must be validated for each customer application by the customer's technical experts. Product specifications do not expand or otherwise modify Vishay's terms and conditions of purchase, including but not limited to the warranty expressed therein.

Except as expressly indicated in writing, Vishay products are not designed for use in medical, life-saving, or life-sustaining applications or for any other application in which the failure of the Vishay product could result in personal injury or death. Customers using or selling Vishay products not expressly indicated for use in such applications do so at their own risk. Please contact authorized Vishay personnel to obtain written terms and conditions regarding products designed for such applications.

No license, express or implied, by estoppel or otherwise, to any intellectual property rights is granted by this document or by any conduct of Vishay. Product names and markings noted herein may be trademarks of their respective owners.

## X-ON Electronics

Largest Supplier of Electrical and Electronic Components

*Click to view similar products for [Thin Film Resistors - SMD category](#):*

*Click to view products by [Vishay manufacturer](#):*

Other Similar products are found below :

[M55342K06B34E0RT3](#) [D55342E07B379BR-TR](#) [AR02BTC1872](#) [AR02BTC18R7](#) [AR02BTC3830](#) [AR02BTC4220](#) [AR02BTC4422](#)  
[AR02BTC5100](#) [AR02BTC5111](#) [AR02BTC5762](#) [AR02BTC8251](#) [AR02BTC8452](#) [AR03BTC0110](#) [AR03BTC0120](#) [AR03BTC0330](#)  
[AR03BTC0390](#) [AR03BTC1102](#) [AR03BTC1103](#) [AR03BTC1201](#) [AR03BTC2000](#) [AR03BTC2201](#) [AR03BTC2203](#) [AR03BTC2490](#)  
[AR03BTC3003](#) [AR03BTC3302](#) [AR03BTC3901](#) [AR03BTC4220](#) [AR03BTC4223N](#) [AR03BTC5602](#) [AR03BTC5603](#) [AR03BTC5900](#)  
[AR03BTC7500](#) [AR03BTC9100](#) [AR03BTC9103](#) [AR03BTC9760](#) [AR05BTC0280](#) [AR05BTC1000](#) [AR05BTC1100](#) [AR05BTC1201](#)  
[AR05BTC1202](#) [AR05BTC1300](#) [AR05BTC14R3](#) [AR05BTC1500](#) [AR05BTC1523](#) [AR05BTC1620](#) [AR05BTC1622](#) [AR05BTC1623](#)  
[AR05BTC1760](#) [AR05BTC1800](#) [AR05BTC1823](#)