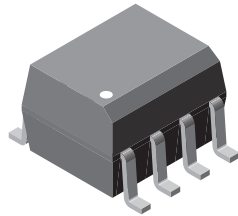
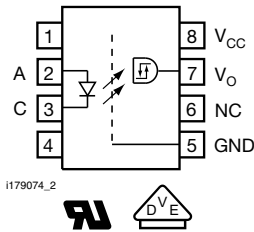




High Speed Optocoupler, Single, 5 MBd, in SOIC-8 Package



i179074



i179074_2



FEATURES

- Data rate 5 Mbits/s (2.5 Mbit/s over temperature)
- Buffer
- Isolation test voltage, 4000 V_{RMS}
- TTL, LSTTL and CMOS compatible
- Internal shield for very high common mode transient immunity
- Wide supply voltage range (4.5 V to 15 V)
- Low input current (1.6 mA to 5 mA)
- Parameters specified from 0 °C to 85 °C
- T_{amb} from -40 °C to 100 °C
- Material categorization: for definitions of compliance please see www.vishay.com/doc?99912


RoHS
COMPLIANT

DESCRIPTION

The single channel 5 Mb/s SFH6720 and SFH6721 high speed optocoupler consists of a GaAlAs infrared emitting diode, optically coupled with an integrated photo detector. The detector incorporates a Schmitt-trigger stage for improved noise immunity. A Faraday shield provides a common mode transient immunity of 1000 V/μs at V_{CM} = 50 V for SFH6720 and 2500 V/μs at V_{CM} = 400 V for SFH6721.

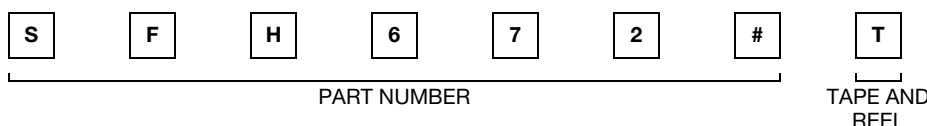
AGENCY APPROVALS

- UL1577, file no. E52744 system code Y
- DIN EN 60747-5-5 (VDE 0884) available with option 1

APPLICATIONS

- Industrial control
- Replace pulse transformers
- Routine logic interfacing
- Motion / power control
- High speed line receiver
- Microprocessor system interfaces
- Computer peripheral interfaces

ORDERING INFORMATION



| AGENCY CERTIFIED/PACKAGE | CMR (kV/μs) | CMR (kV/μs) |
|--------------------------|---------------|-------------|
| UL | 1 | 2.5 |
| SOIC-8 | SFH6720T | SFH6721T |
| VDE, UL | 1 | 2.5 |
| SOIC-8 | SFH6720-X001T | - |

TRUTH TABLE (positive logic)

| PART | IR DIODE | OUTPUT |
|---------|----------|--------|
| SFH6720 | On | H |
| | Off | L |
| SFH6721 | On | H |
| | Off | L |



| ABSOLUTE MAXIMUM RATINGS ⁽¹⁾ ($T_{amb} = 25\text{ }^{\circ}\text{C}$, unless otherwise specified) | | | | |
|--|--|------------|-------------|--------------------|
| PARAMETER | TEST CONDITION | SYMBOL | VALUE | UNIT |
| INPUT | | | | |
| Reverse voltage | | V_R | 3 | V |
| DC forward current | | I_F | 10 | mA |
| Surge forward | $t_p \leq 1\text{ }\mu\text{s}$, 300 pulses/s | I_{FSM} | 1 | mA |
| Power dissipation | | P_{diss} | 20 | mW |
| OUTPUT | | | | |
| Supply voltage | | V_{CC} | -0.5 to +15 | V |
| Output voltage | | V_O | -0.5 to +15 | V |
| Average output current | | I_O | 25 | mA |
| Power dissipation | | P_{diss} | 100 | mW |
| COUPLER | | | | |
| Storage temperature range | | T_{stg} | -55 to +125 | $^{\circ}\text{C}$ |
| Ambient temperature range | | T_{amb} | + 85 | $^{\circ}\text{C}$ |
| Lead soldering temperature | $t = 10\text{ s}$ | T_{slid} | 260 | $^{\circ}\text{C}$ |

Note

- ⁽¹⁾ Stresses in excess of the absolute maximum ratings can cause permanent damage to the device. Functional operation of the device is not implied at these or any other conditions in excess of those given in the operational sections of this document. Exposure to absolute maximum ratings for extended periods of the time can adversely affect reliability

| RECOMMENDED OPERATING CONDITIONS ⁽¹⁾ | | | | | | |
|---|----------------|------------|--------------------|------|------|--------------------|
| PARAMETER | TEST CONDITION | SYMBOL | MIN. | TYP. | MAX. | UNIT |
| Supply voltage | | V_{CC} | 4.5 | | 15 | V |
| Forward input current | | I_{Fon} | 1.6 ⁽²⁾ | | 5 | mA |
| | | I_{Foff} | | | 0.1 | mA |
| Operating temperature | | T_A | -40 | | 85 | $^{\circ}\text{C}$ |

Notes

- ⁽¹⁾ A 0.1 μF bypass capacitor connected between pins 5 and 8 must be used
⁽²⁾ We recommended using a 2.2 mA if to permit at least 20 % CTR degradation guard band

| ELECTRICAL CHARACTERISTICS ⁽¹⁾ | | | | | | |
|---|--|------------|------|------|------|---------------|
| PARAMETER | TEST CONDITION | SYMBOL | MIN. | TYP. | MAX. | UNIT |
| INPUT | | | | | | |
| Forward voltage | $I_F = 5\text{ mA}$, $25\text{ }^{\circ}\text{C}$ | V_F | | 1.6 | 1.75 | V |
| | | V_F | | | 1.9 | V |
| Input current hysteresis | $V_{CC} = 5\text{ V}$, $I_{HYS} = I_{Fon} - I_{Foff}$ | I_{HYS} | 0.1 | | | V |
| Reverse current | $V_R = 3\text{ V}$ | I_R | | 0.5 | 10 | μA |
| Capacitance | $V_R = 0\text{ V}$, $f = 1\text{ MHz}$ | C_O | | 60 | | pF |
| Thermal resistance | | R_{thja} | | 700 | | K/W |



| ELECTRICAL CHARACTERISTICS (1) | | | | | | |
|--|--|------------|------|------|------|---------------|
| PARAMETER | TEST CONDITION | SYMBOL | MIN. | TYP. | MAX. | UNIT |
| OUTPUT | | | | | | |
| Logic low output voltage | $I_{OL} = 6.4 \text{ mA}$ | V_{OL} | | | 0.5 | V |
| Logic high output voltage | $I_{OH} = -2.6 \text{ mA}$, $V_{OH} = V_{CC} - 1.8 \text{ V}$ | V_{OH} | 2.4 | | | V |
| Output leakage current ($V_{OUT} > V_{CC}$) | $V_O = 5.5 \text{ V}$, $V_{CC} = 4.5 \text{ V}$, $I_F = 5 \text{ mA}$ | I_{OHH} | | 0.5 | 100 | μA |
| | $V_O = 15 \text{ V}$, $V_{CC} = 4.5 \text{ V}$, $I_F = 5 \text{ mA}$ | I_{OHH} | | 1 | 500 | μA |
| Logic low supply current | $V_{CC} = 5.5 \text{ V}$, $I_F = 0$ | I_{CCL} | | 3.7 | 6 | mA |
| | $V_{CC} = 15 \text{ V}$, $I_F = 0$ | I_{CCL} | | 4.1 | 6.5 | mA |
| Logic high supply current | $V_{CC} = 5.5 \text{ V}$, $I_F = 5 \text{ mA}$ | I_{CCH} | | 3.4 | 4 | mA |
| | $V_{CC} = 15 \text{ V}$, $I_F = 5 \text{ mA}$ | I_{CCH} | | 3.7 | 5 | mA |
| Logic low short circuit output current (output short circuit time $\leq 10 \text{ ms}$) | $V_O = V_{CC} = 5.5 \text{ V}$, $I_F = 0$ | I_{OSL} | 25 | | | mA |
| | $V_O = V_{CC} = 15 \text{ V}$, $I_F = 0$ | I_{OSL} | 40 | | | mA |
| Logic high short circuit output current (output short circuit time $\leq 10 \text{ ms}$) | $V_{CC} = 5.5 \text{ V}$, $V_O = 0 \text{ V}$, $I_F = 5 \text{ mA}$ | I_{OSH} | | | -10 | mA |
| | $V_{CC} = 15 \text{ V}$, $V_O = 0 \text{ V}$, $I_F = 5 \text{ mA}$ | I_{OSH} | | | -25 | mA |
| Thermal resistance | | R_{thja} | | 300 | | K/W |
| COUPLER | | | | | | |
| Capacitance (input to output) | $f = 1 \text{ MHz}$, pins 1 to 4 and 5 to 8 shorted together | C_{IO} | | 0.6 | | pF |

Note

(1) $-40^\circ\text{C} \leq T_{amb} \leq 85^\circ\text{C}$; $4.5 \text{ V} \leq V_{CC} \leq 15 \text{ V}$; $1.6 \text{ mA} \leq I_{Fon} \leq 5 \text{ mA}$; $2 \leq V_{EH} \leq 15 \text{ V}$; $0 \leq V_{EL} \leq 0.8 \text{ V}$; $0 \text{ mA} \leq I_{Foff} \leq 0.1 \text{ mA}$.

Typical values: $T_{amb} = 25^\circ\text{C}$; $V_{CC} = 5 \text{ V}$; $I_{Fon} = 3 \text{ mA}$ unless otherwise specified.

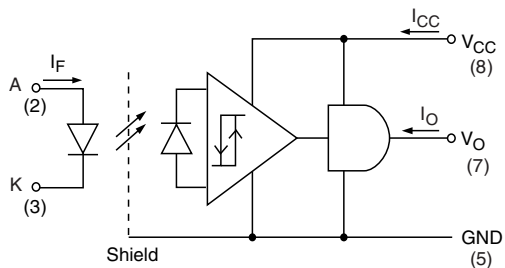
Minimum and maximum values are testing requirements. Typical values are characteristics of the device and are the result of engineering evaluation. Typical values are for information only and are not part of the testing requirements

| SWITCHING CHARACTERISTICS (1) | | | | | | |
|---|---------------------------|-----------|------|------|------|------|
| PARAMETER | TEST CONDITION | SYMBOL | MIN. | TYP. | MAX. | UNIT |
| Propagation delay time to logic low output level | Without peaking capacitor | t_{PHL} | | 120 | | ns |
| | With peaking capacitor | t_{PHL} | | 115 | 300 | ns |
| Propagation delay time to logic high output level | Without peaking capacitor | t_{PLH} | | 125 | | ns |
| | With peaking capacitor | t_{PLH} | | 90 | 300 | ns |
| Output rise time | 10 % to 90 % | t_r | | 40 | | ns |
| Output fall time | 90 % to 10 % | t_f | | 10 | | ns |

Note

(1) $0^\circ\text{C} \leq T_{amb} \leq 85^\circ\text{C}$; $4.5 \text{ V} \leq V_{CC} \leq 15 \text{ V}$; $1.6 \text{ mA} \leq I_{Fon} \leq 5 \text{ mA}$; $0 \text{ mA} \leq I_{Foff} \leq 0.1 \text{ mA}$

Typical values: $T_{amb} = 25^\circ\text{C}$; $V_{CC} = 5 \text{ V}$; $I_{Fon} = 3 \text{ mA}$ unless otherwise specified. A $0.1 \mu\text{F}$ bypass capacitor connected between pins 5 and 8 must be used



isfh6720_00

**COMMON MODE TRANSIENT IMMUNITY (1)**

| PARAMETER | TEST CONDITION | PART | SYMBOL | MIN. | TYP. | MAX. | UNIT |
|---|---|---------|----------|--------|------|------|------------------|
| Logic high common mode transient immunity (2) | $ V_{CM} = 50 \text{ V}$, $I_F = 1.6 \text{ mA}$ | SFH6720 | $ CM_H $ | 1000 | | | V/ μs |
| | $ V_{CM} = 300 \text{ V}$, $I_F = 1.6 \text{ mA}$ | SFH6721 | $ CM_H $ | 5000 | | | V/ μs |
| Logic low common mode transient immunity (2) | $ V_{CM} = 50 \text{ V}$, $I_F = 0 \text{ mA}$ | SFH6720 | $ CM_L $ | 1000 | | | V/ μs |
| | $ V_{CM} = 1000 \text{ V}$, $I_F = 0 \text{ mA}$ | SFH6721 | $ CM_L $ | 10 000 | | | V/ μs |

Note(1) $T_{amb} = 25 \text{ }^\circ\text{C}$, $V_{CC} = 5 \text{ V}$ (2)(2) CM_H is the maximum slew rate of a common mode voltage V_{CM} at which the output voltage remains at logic high level ($V_O > 2 \text{ V}$). CM_L is the maximum slew rate of a common mode voltage V_{CM} at which the output voltage remains at logic low level ($V_O < 0.8 \text{ V}$)**SAFETY AND INSULATION RATINGS**

| PARAMETER | TEST CONDITION | SYMBOL | VALUE | UNIT |
|--|---|------------|----------------|------------------|
| Climatic classification | According to IEC 68 part 1 | | 55/100/21 | |
| Pollution degree | According to DIN VDE 0109 | | 2 | |
| Comparative tracking index | Insulation group IIIa | CTI | 175 | |
| Maximum rated withstanding isolation voltage | According to UL1577, $t = 1 \text{ min}$ | V_{ISO} | 3333 | V_{RMS} |
| Tested withstanding isolation voltage | According to UL1577, $t = 1 \text{ s}$ | V_{ISO} | 4000 | V_{RMS} |
| Maximum transient isolation voltage | According to DIN EN 60747-5-5 | V_{IOTM} | 6000 | V_{peak} |
| Maximum repetitive peak isolation voltage | According to DIN EN 60747-5-5 | V_{IORM} | 560 | V_{peak} |
| Isolation resistance | $V_{IO} = 500 \text{ V}$, $T_{amb} = 25 \text{ }^\circ\text{C}$ | R_{IO} | $\geq 10^{12}$ | Ω |
| | $V_{IO} = 500 \text{ V}$, $T_{amb} = 100 \text{ }^\circ\text{C}$ | R_{IO} | $\geq 10^{11}$ | Ω |
| Output safety power | | P_{SO} | 350 | mW |
| Input safety current | | I_{SI} | 150 | mA |
| Input safety temperature | | T_S | 165 | $^\circ\text{C}$ |
| Creepage distance | SOIC-8 | | ≥ 4 | mm |
| Clearance distance | SOIC-8 | | ≥ 4 | mm |
| Insulation thickness | | DTI | ≥ 0.2 | mm |

Note

As per IEC 60747-5-5, § 7.4.3.8.2, this optocoupler is suitable for "safe electrical insulation" only within the safety ratings. Compliance with the safety ratings shall be ensured by means of protective circuits

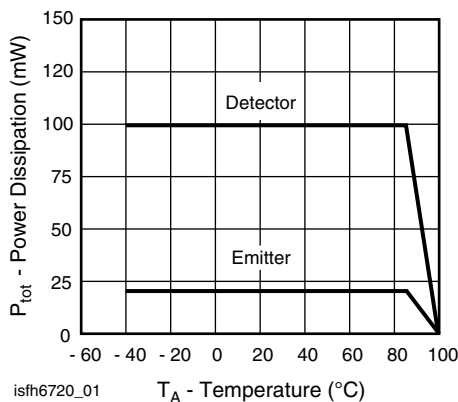
TYPICAL CHARACTERISTICS ($T_{amb} = 25 \text{ }^\circ\text{C}$, unless otherwise specified)

Fig. 1 - Permissible Total Power Dissipation vs. Temperature

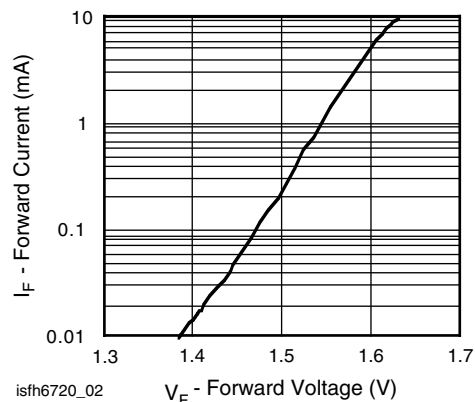


Fig. 2 - Typical Input Diode Forward Current vs. Forward Voltage

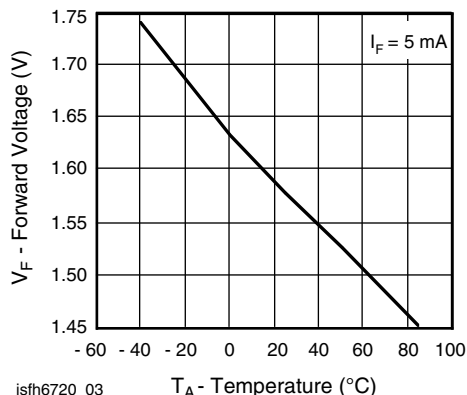


Fig. 3 - Typical Forward Input Voltage vs. Temperature

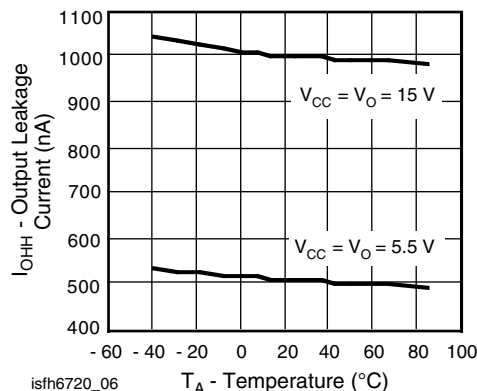


Fig. 6 - Typical Output Leakage Current vs. Temperature

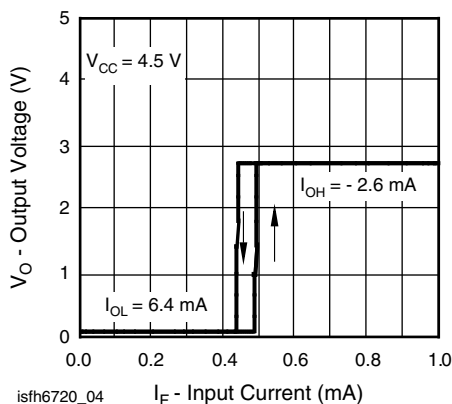


Fig. 4 - Typical Output Voltage vs. Forward Input Current

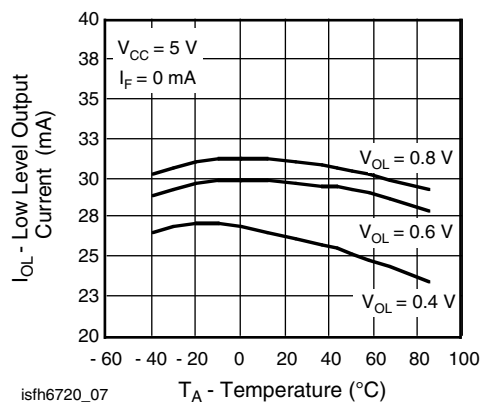


Fig. 7 - Typical Low Level Output Current vs. Temperature

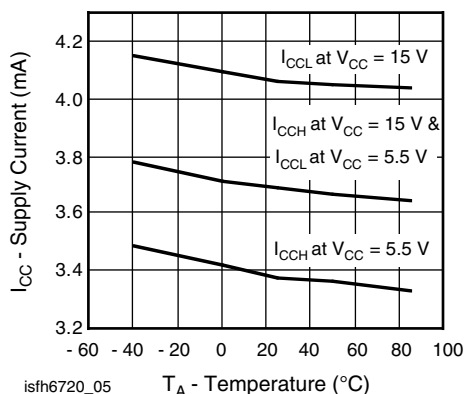


Fig. 5 - Typical Supply Current vs. Temperature

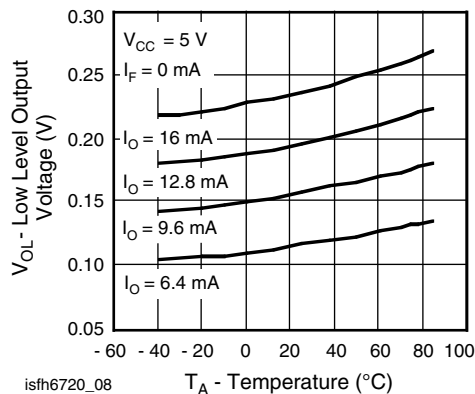


Fig. 8 - Typical Low Level Output Voltage vs. Temperature

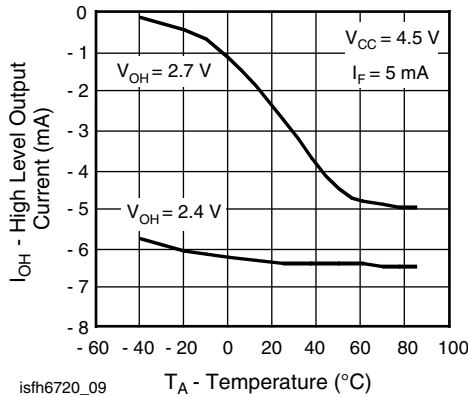


Fig. 9 - Typical High Level Output Current vs. Temperature

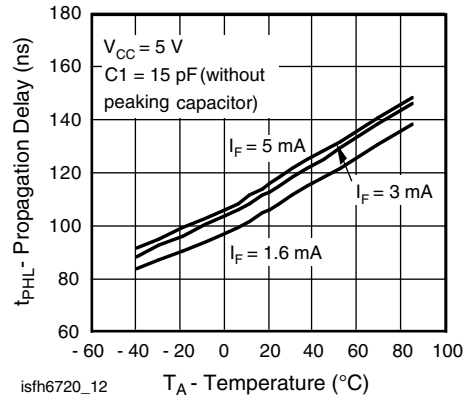


Fig. 12 - Typical Propagation Delays to Logic Low vs. Temperature

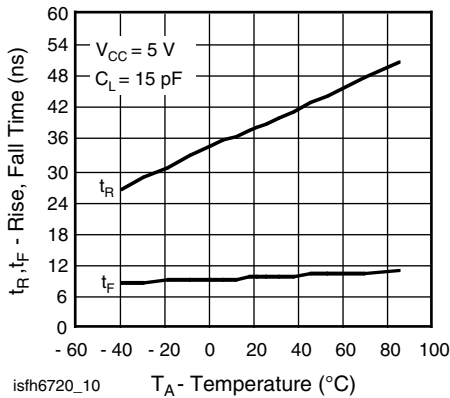


Fig. 10 - Rise and Fall Time vs. Ambient Temperature

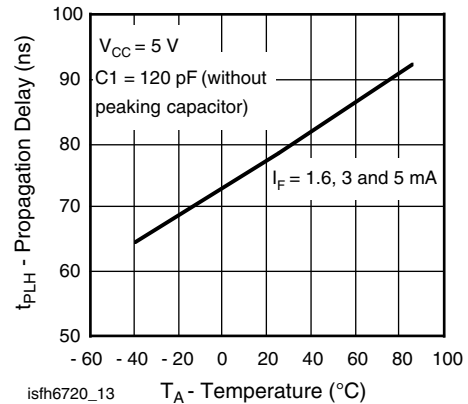


Fig. 13 - Typical Propagation Delays to Logic High vs. Temperature

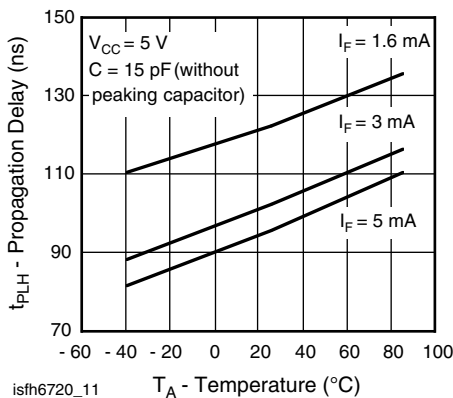


Fig. 11 - Typical Propagation Delays to Logic High vs. Temperature

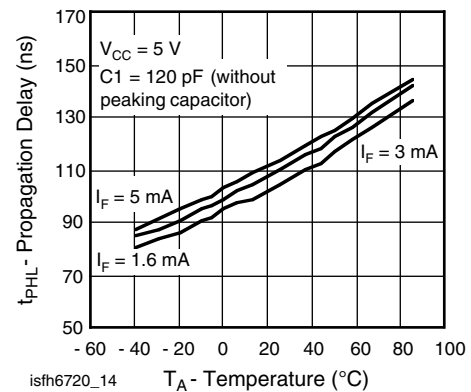


Fig. 14 - Typical Propagation Delays to Logic Low vs. Temperature

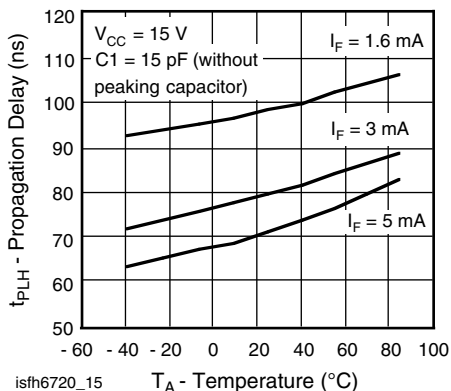


Fig. 15 - Typical Propagation Delays to Logic High vs. Temperature

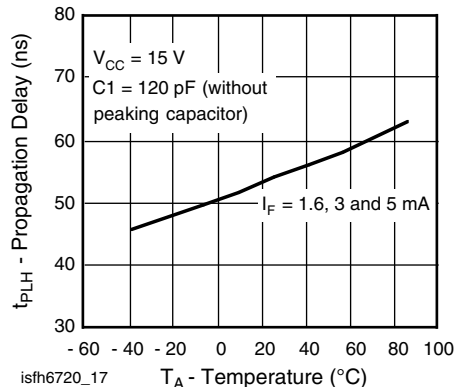


Fig. 17 - Typical Propagation Delays to Logic High vs. Temperature

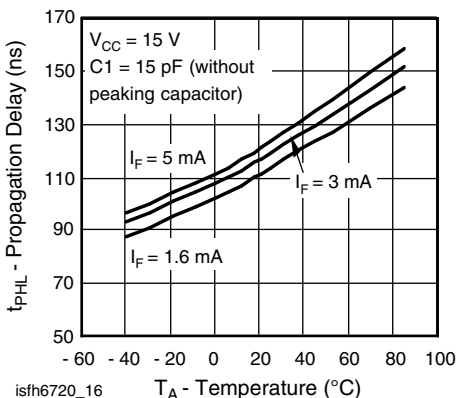


Fig. 16 - Typical Propagation Delays to Logic Low vs. Temperature

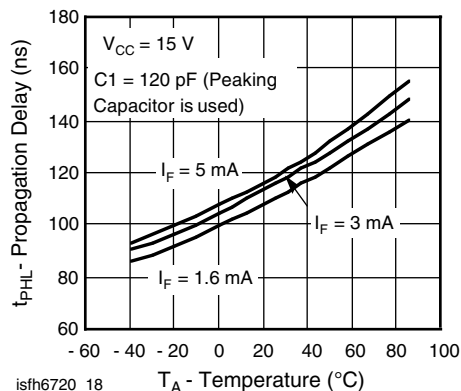


Fig. 18 - Typical Propagation Delays to Logic Low vs. Temperature

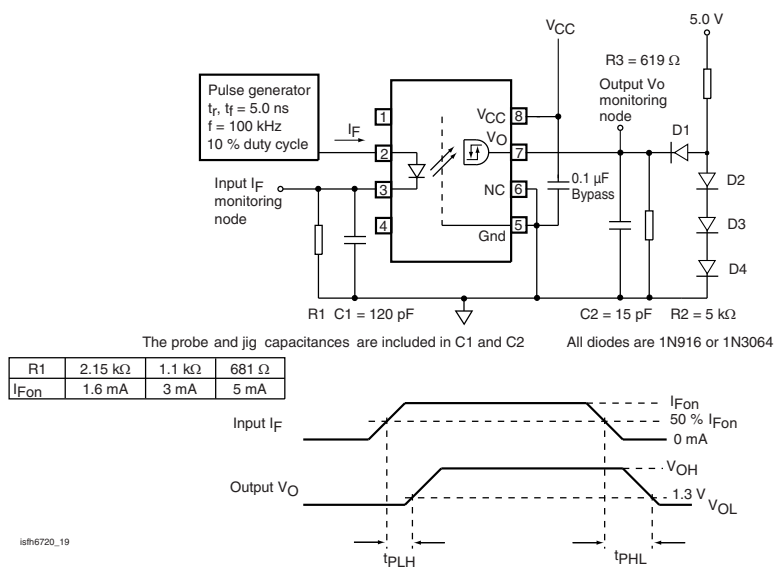


Fig. 19 - Test Circuit for tPLH, tPHL, tR and tF

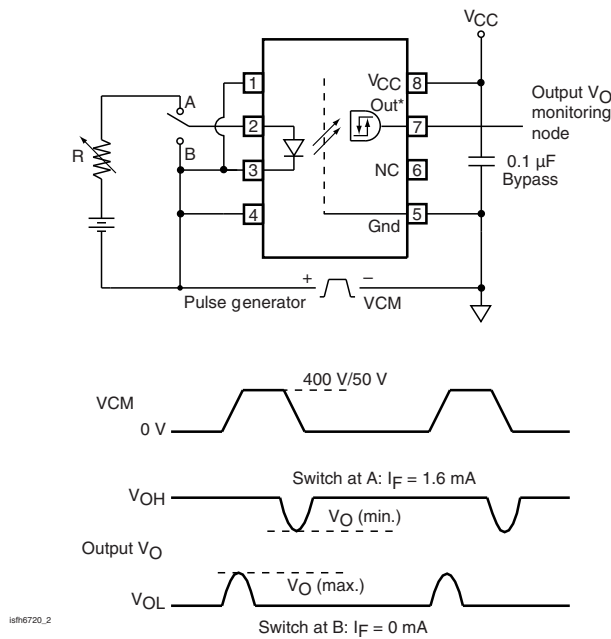


Fig. 20 - Test Circuit for Common Mode Transient Immunity and Typical Waveforms

PACKAGE DIMENSIONS (in millimeters)

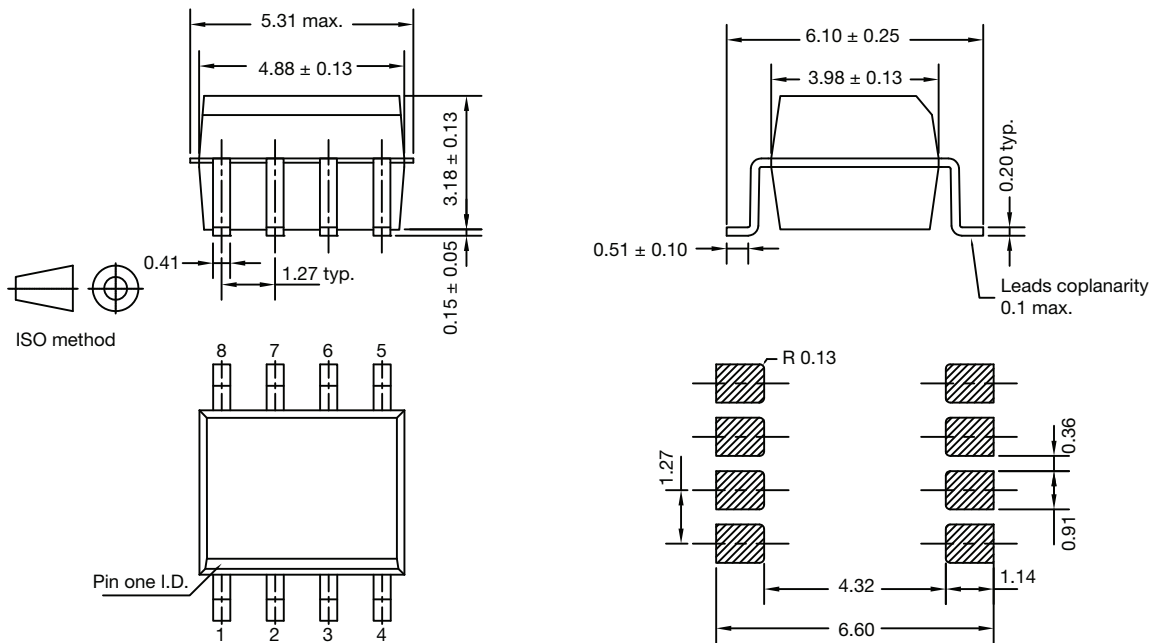


Fig. 21 - Package Dimensions

PACKAGE MARKING



Fig. 22 - SFH6720

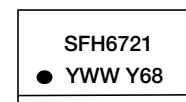


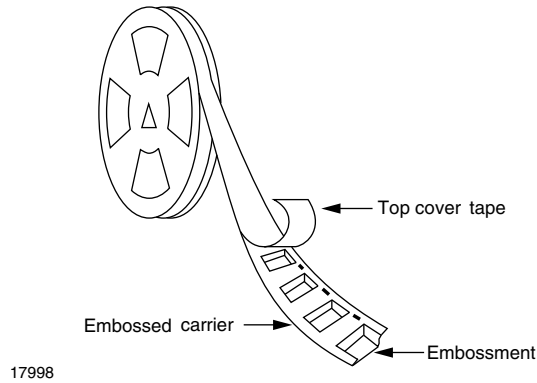
Fig. 23 - SFH6721

Note

- Tape and reel suffix (T) is not part of the package marking

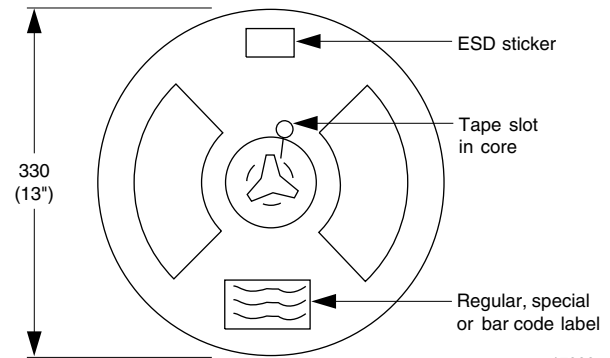


PACKAGE INFORMATION (in millimeters)



17998

Fig. 24 - Tape and Reel Shipping Medium



17999

Fig. 25 - Tape and Reel Shipping Medium

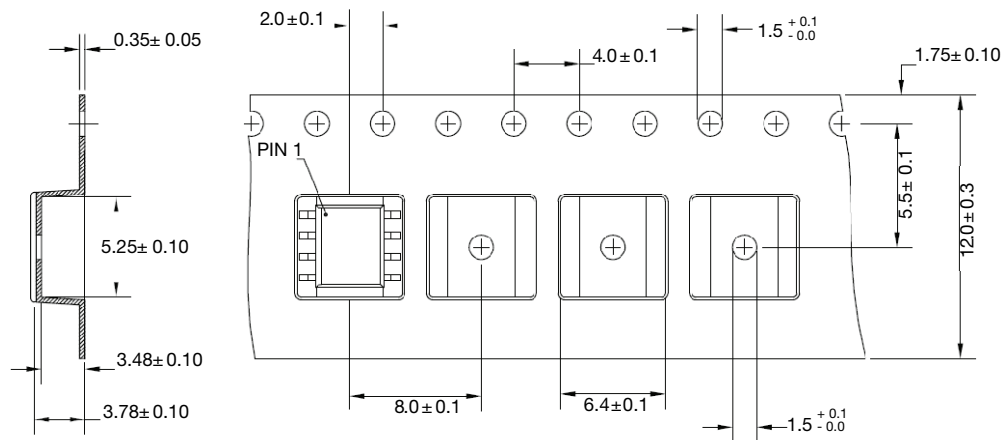
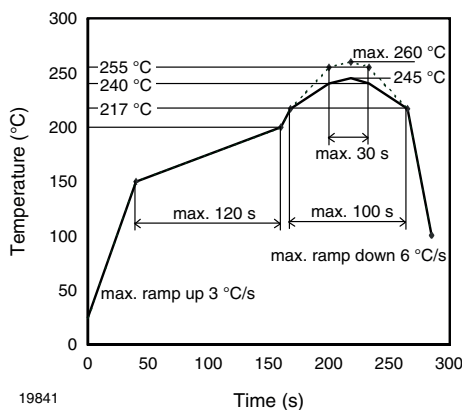


Fig. 26 - Tape and Reel Packing for SOIC (2000 pieces on reel)

SOLDER PROFILES



19841

Fig. 27 - Lead (Pb)-free Reflow Solder Profile According to J-STD-020 for SMD Devices

HANDLING AND STORAGE CONDITIONS

ESD level: HBM class 2

Floor life: unlimited

Conditions: $T_{amb} < 30\text{ }^{\circ}\text{C}$, $RH < 85\%$

Moisture sensitivity level 1, according to J-STD-020



Disclaimer

ALL PRODUCT, PRODUCT SPECIFICATIONS AND DATA ARE SUBJECT TO CHANGE WITHOUT NOTICE TO IMPROVE RELIABILITY, FUNCTION OR DESIGN OR OTHERWISE.

Vishay Intertechnology, Inc., its affiliates, agents, and employees, and all persons acting on its or their behalf (collectively, "Vishay"), disclaim any and all liability for any errors, inaccuracies or incompleteness contained in any datasheet or in any other disclosure relating to any product.

Vishay makes no warranty, representation or guarantee regarding the suitability of the products for any particular purpose or the continuing production of any product. To the maximum extent permitted by applicable law, Vishay disclaims (i) any and all liability arising out of the application or use of any product, (ii) any and all liability, including without limitation special, consequential or incidental damages, and (iii) any and all implied warranties, including warranties of fitness for particular purpose, non-infringement and merchantability.

Statements regarding the suitability of products for certain types of applications are based on Vishay's knowledge of typical requirements that are often placed on Vishay products in generic applications. Such statements are not binding statements about the suitability of products for a particular application. It is the customer's responsibility to validate that a particular product with the properties described in the product specification is suitable for use in a particular application. Parameters provided in datasheets and / or specifications may vary in different applications and performance may vary over time. All operating parameters, including typical parameters, must be validated for each customer application by the customer's technical experts. Product specifications do not expand or otherwise modify Vishay's terms and conditions of purchase, including but not limited to the warranty expressed therein.

Except as expressly indicated in writing, Vishay products are not designed for use in medical, life-saving, or life-sustaining applications or for any other application in which the failure of the Vishay product could result in personal injury or death. Customers using or selling Vishay products not expressly indicated for use in such applications do so at their own risk. Please contact authorized Vishay personnel to obtain written terms and conditions regarding products designed for such applications.

No license, express or implied, by estoppel or otherwise, to any intellectual property rights is granted by this document or by any conduct of Vishay. Product names and markings noted herein may be trademarks of their respective owners.

X-ON Electronics

Largest Supplier of Electrical and Electronic Components

Click to view similar products for [High Speed Optocouplers](#) category:

Click to view products by [Vishay](#) manufacturer:

Other Similar products are found below :

[PS8502L2-AX](#) [ACNW261L-000E](#) [ACPL-344JT-000E](#) [ACPL-K49T-500E](#) [ACPL-K74T-000E](#) [ACPL-K75T-000E](#) [ACPL-W21L-560E](#)
[ACNW261L-500E](#) [ACPL-K44T-500E](#) [TLP187\(TPL,E\(T](#) [TLP2601\(TP1,F\)](#) [610737H](#) [6N137A-X001](#) [6N137A-X017T](#) [6N139-X007T](#)
[HCPL2630M](#) [HCPL2731SM](#) [HCPL2630SM](#) [PS2841-4A-F3-AX](#) [PS9817A-1-F3-AX](#) [PS9821-2-F3-AX](#) [ORPC-817D](#) [ORPC-817M/C](#) [ORPC-](#)
[817M/B](#) [PT17-51C/L129\(BIN2\)](#) [TLP521-4GBSM](#) [UMW817C](#) [6N137S1\(TA\)](#) [TLP521GB](#) [TLP521GB-S](#) [PS2501](#) [PS2501-S](#) [TLP785GB](#)
[TLP785GB-S](#) [LTV-214-G](#) [LCR-0202](#) [EL814S1\(TA\)-V](#) [PC817X4NSZ2B](#) [CYPC817](#) [OR-MOC3023](#) [TLP267J\(TPL,E\(T](#) [TLP109\(TPL,E\(O](#)
[EL2514S1\(TU\)\(CLW\)-G](#) [EL817S1\(C\)\(TU\)-G](#) [EL816S2\(C\)\(TU\)-F](#) [TLP281-4](#) [MOC3023M](#) [ACPL-K49T-060E](#) [ACPL-K75T-500E](#) [ACPL-](#)
[W484-500E](#)