

N-Channel 240-V (D-S) MOSFET

PRODUCT SUMMARY			
V _{DS} (V)	R _{DS(on)} (Ω)	I _D (A)	Q _g (Typ.)
240	2.9 at V _{GS} = 10 V	1.52	2.54 nC
	2.95 at V _{GS} = 4.5 V	1.5	
	3.5 at V _{GS} = 2.5 V	1.44	

FEATURES

- Halogen-free
- TrenchFET® Power MOSFET
- New Thermally Enhanced PowerPAK® SC-70 Package
 - Small Footprint Area
 - Low On-Resistance



RoHS
COMPLIANT

APPLICATIONS

- Boost Converter for Portable Devices

PowerPAK SC-70-6L-Single

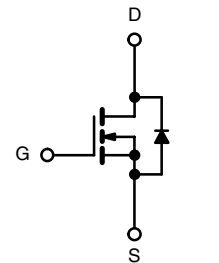
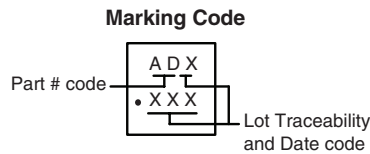
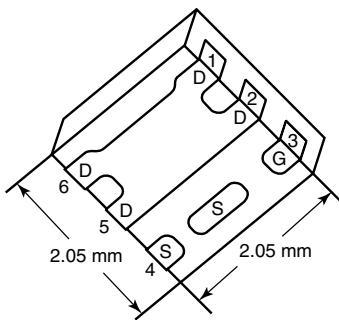

Ordering Information: SiA450DJ-T1-GE3 (Lead (Pb)-free and Halogen-free)

N-Channel MOSFET

ABSOLUTE MAXIMUM RATINGS T _A = 25 °C, unless otherwise noted				
Parameter	Symbol	Limit	Unit	
Drain-Source Voltage	V _{DS}	240	V	
Gate-Source Voltage	V _{GS}	± 20		
Continuous Drain Current (T _J = 150 °C)	T _C = 25 °C	I _D	1.52	A
	T _C = 70 °C		1.21	
	T _A = 25 °C		0.70 ^{a, b}	
	T _A = 70 °C		0.56 ^{a, b}	
Pulsed Drain Current	I _{DM}	1.5		
Continuous Source-Drain Diode Current	T _C = 25 °C	I _S	12.8	
	T _A = 25 °C		2.74 ^{a, b}	
Maximum Power Dissipation	T _C = 25 °C	P _D	15	W
	T _C = 70 °C		9.8	
	T _A = 25 °C		3.3 ^{a, b}	
	T _A = 70 °C		2.1 ^{a, b}	
Operating Junction and Storage Temperature Range		T _J , T _{stg}	- 55 to 150	°C
Soldering Recommendations (Peak Temperature) ^{c, d}			260	

THERMAL RESISTANCE RATINGS				
Parameter	Symbol	Typical	Maximum	Unit
Maximum Junction-to-Ambient ^{a, e}	R _{thJA}	30	38	°C/W
Maximum Junction-to-Case (Drain)	R _{thJC}	6.5	8.1	

Notes:

a. Surface Mounted on 1" x 1" FR4 board.

b. t = 5 s.

c. See Solder Profile (<http://www.vishay.com/ppg?73257>). The PowerPAK SC-70 is a leadless package. The end of the lead terminal is exposed copper (not plated) as a result of the singulation process in manufacturing. A solder fillet at the exposed copper tip cannot be guaranteed and is not required to ensure adequate bottom side solder interconnection.

d. Rework Conditions: manual soldering with a soldering iron is not recommended for leadless components.

e. Maximum under Steady State conditions is 80 °C/W.

SPECIFICATIONS $T_J = 25\text{ }^\circ\text{C}$, unless otherwise noted						
Parameter	Symbol	Test Conditions	Min.	Typ.	Max.	Unit
Static						
Drain-Source Breakdown Voltage	V_{DS}	$V_{GS} = 0\text{ V}, I_D = -250\text{ }\mu\text{A}$	240			V
V_{DS} Temperature Coefficient	$\Delta V_{DS}/T_J$	$I_D = -250\text{ }\mu\text{A}$		247.4		mV/°C
$V_{GS(th)}$ Temperature Coefficient	$\Delta V_{GS(th)}/T_J$			4.22		
Gate-Source Threshold Voltage	$V_{GS(th)}$	$V_{DS} = V_{GS}, I_D = -250\text{ }\mu\text{A}$	0.8		2.4	V
Gate-Source Leakage	I_{GSS}	$V_{DS} = 0\text{ V}, V_{GS} = \pm 20\text{ V}$			± 100	nA
Zero Gate Voltage Drain Current	I_{DSS}	$V_{DS} = 240\text{ V}, V_{GS} = 0\text{ V}$			-1	μA
		$V_{DS} = 240\text{ V}, V_{GS} = 0\text{ V}, T_J = 55\text{ }^\circ\text{C}$			-10	
On-State Drain Current ^a	$I_{D(on)}$	$V_{DS} \leq 10\text{ V}, V_{GS} = 10\text{ V}$	1.5			A
Drain-Source On-State Resistance ^a	$R_{DS(on)}$	$V_{GS} = 10\text{ V}, I_D = 0.70\text{ A}$		2.4	2.9	Ω
		$V_{GS} = 4.5\text{ V}, I_D = 0.65\text{ A}$		2.46	2.95	
		$V_{GS} = 2.5\text{ V}, I_D = 0.50\text{ A}$		2.85	3.5	
Forward Transconductance ^a	g_{fs}	$V_{DS} = 120\text{ V}, I_D = 0.70\text{ A}$		3.14		S
Dynamic^b						
Input Capacitance	C_{iss}	$V_{DS} = 120\text{ V}, V_{GS} = 0\text{ V}, f = 1\text{ MHz}$		167		pF
Output Capacitance	C_{oss}			10		
Reverse Transfer Capacitance	C_{rss}			3.4		
Total Gate Charge	Q_g	$V_{DS} = 120\text{ V}, V_{GS} = 10\text{ V}, I_D = 0.70\text{ A}$		4.69	7.035	nC
				2.54	3.81	
Gate-Source Charge	Q_{gs}	$V_{DS} = 120\text{ V}, V_{GS} = 4.5\text{ V}, I_D = 0.70\text{ A}$		0.58		
Gate-Drain Charge	Q_{gd}			1.14		
Gate Resistance	R_g	$f = 1\text{ MHz}$		2		Ω
Turn-On Delay Time	$t_{d(on)}$	$V_{DD} = 120\text{ V}, R_L = 200\text{ }\Omega$ $I_D \cong 0.60\text{ A}, V_{GEN} = 4.5\text{ V}, R_g = 1\text{ }\Omega$		13.7	21	ns
Rise Time	t_r			22	33	
Turn-Off Delay Time	$t_{d(off)}$			23	35	
Fall Time	t_f			19	29	
Turn-On Delay Time	$t_{d(on)}$	$V_{DD} = 120\text{ V}, R_L = 184\text{ }\Omega$ $I_D \cong 0.70\text{ A}, V_{GEN} = 10\text{ V}, R_g = 1\text{ }\Omega$		4.5	6.75	
Rise Time	t_r			11	16.5	
Turn-Off Delay Time	$t_{d(off)}$			12	18	
Fall Time	t_f			15	22.5	
Drain-Source Body Diode Characteristics						
Continuous Source-Drain Diode Current	I_S	$T_C = 25\text{ }^\circ\text{C}$			2.7	A
Pulse Diode Forward Current	I_{SM}				12.8	
Body Diode Voltage	V_{SD}	$I_S = 0.5\text{ A}, V_{GS} = 0\text{ V}$		0.8	1.2	V
Body Diode Reverse Recovery Time	t_{rr}	$I_F = 0.5\text{ A}, di/dt = 100\text{ A}/\mu\text{s}, T_J = 25\text{ }^\circ\text{C}$		50.2	75.3	ns
Body Diode Reverse Recovery Charge	Q_{rr}			68	102	nC
Reverse Recovery Fall Time	t_a			25		ns
Reverse Recovery Rise Time	t_b			25.2		

Notes:

- a. Pulse test; pulse width $\leq 300\text{ }\mu\text{s}$, duty cycle $\leq 2\%$.
b. Guaranteed by design, not subject to production testing.

Stresses beyond those listed under "Absolute Maximum Ratings" may cause permanent damage to the device. These are stress ratings only, and functional operation of the device at these or any other conditions beyond those indicated in the operational sections of the specifications is not implied. Exposure to absolute maximum rating conditions for extended periods may affect device reliability.



TYPICAL CHARACTERISTICS 25 °C, unless otherwise noted

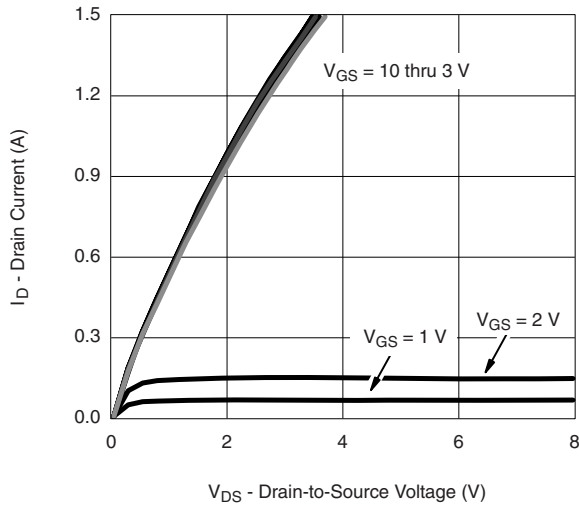

Output Characteristics

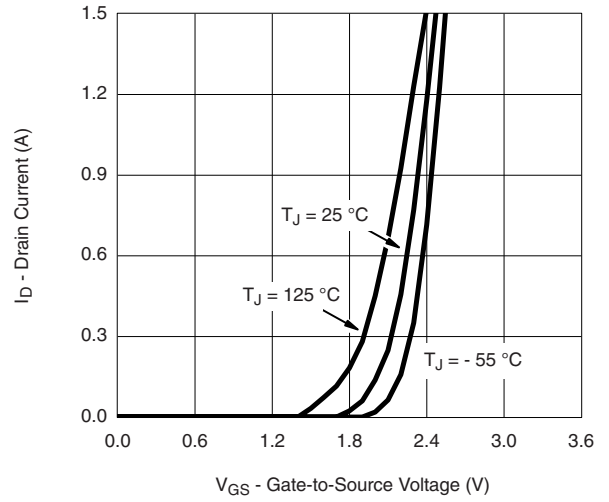

Transfer Characteristics

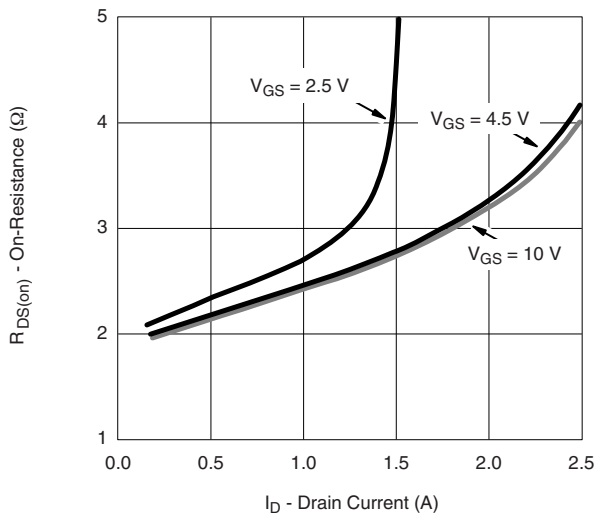

On-Resistance vs. Drain Current and Gate Voltage

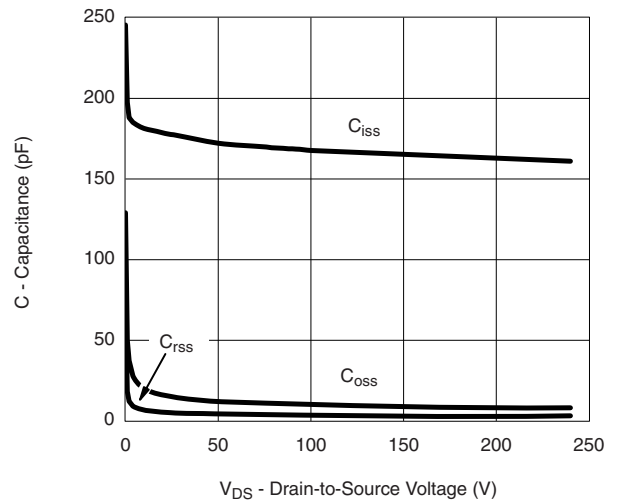

Capacitance

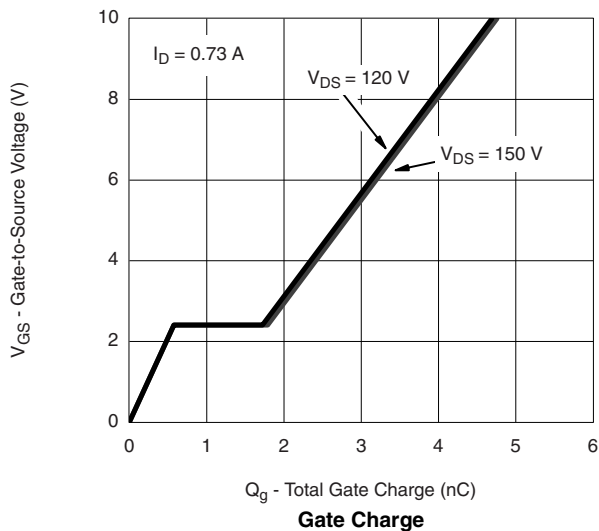

Gate Charge

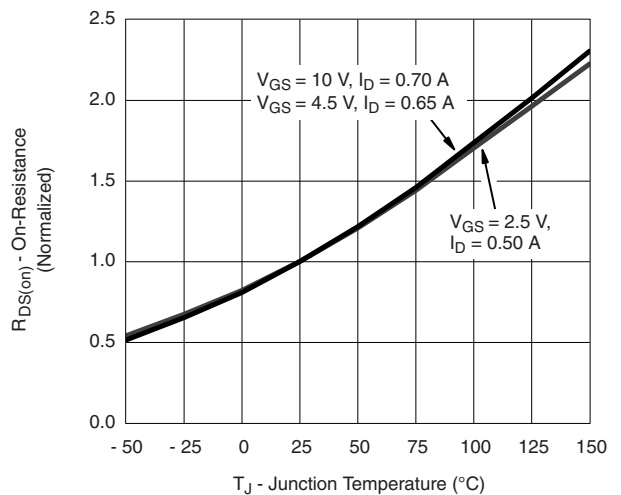

On-Resistance vs. Junction Temperature



TYPICAL CHARACTERISTICS 25 °C, unless otherwise noted

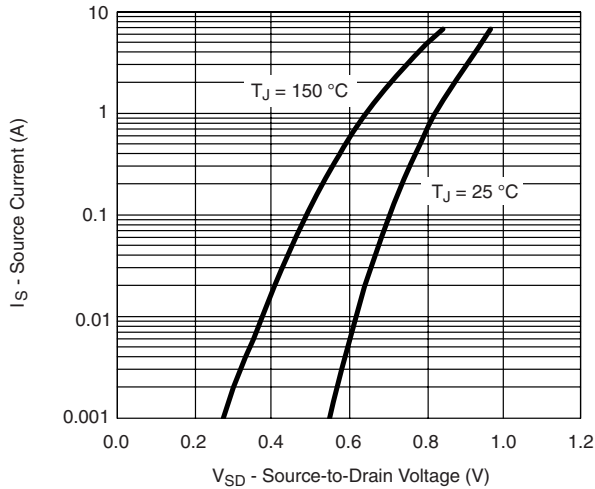

Source-Drain Diode Forward Voltage

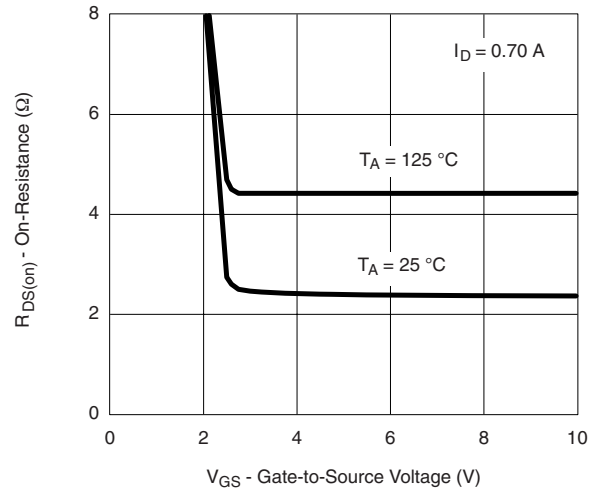

On-Resistance vs. Gate-to-Source Voltage

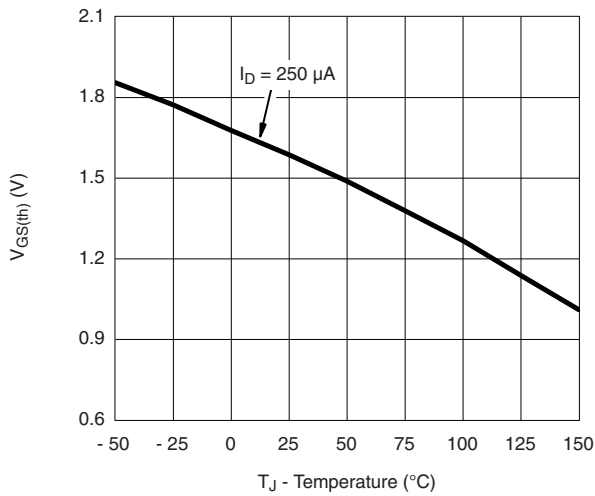

Threshold Voltage

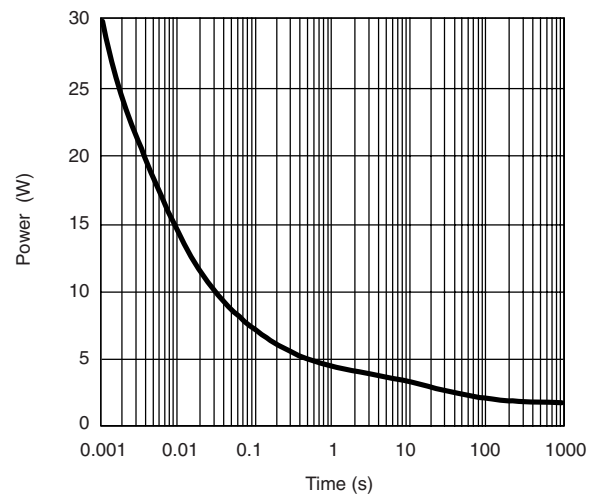

Single Pulse Power, Junction-to-Ambient

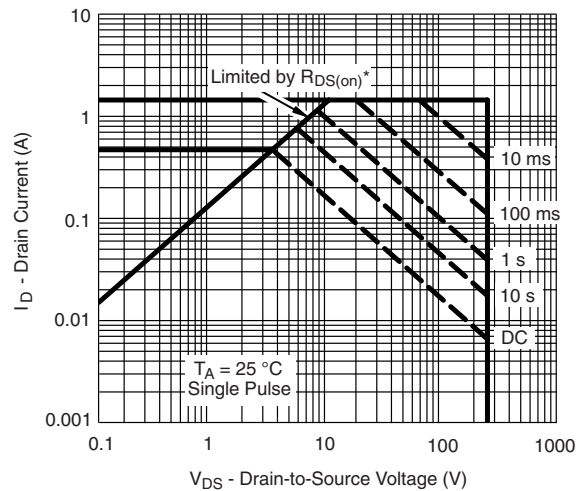

* $V_{GS} >$ minimum V_{GS} at which $R_{DS(on)}$ is specified

Safe Operating Area, Junction-to-Ambient



TYPICAL CHARACTERISTICS 25 °C, unless otherwise noted

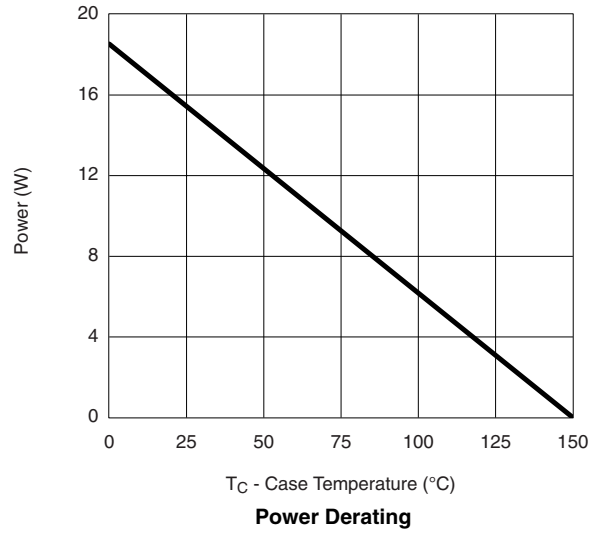
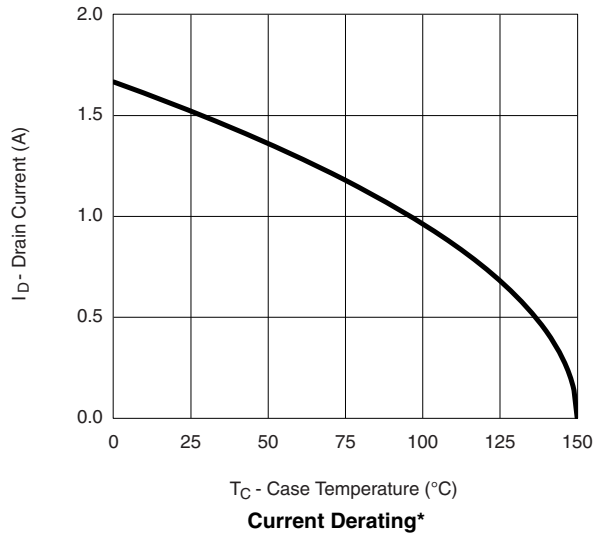

* The power dissipation P_D is based on $T_{J(max)} = 150$ °C, using junction-to-case thermal resistance, and is more useful in settling the upper dissipation limit for cases where additional heatsinking is used. It is used to determine the current rating, when this rating falls below the package limit.

SiA450DJ

Vishay Siliconix



TYPICAL CHARACTERISTICS 25 °C, unless otherwise noted

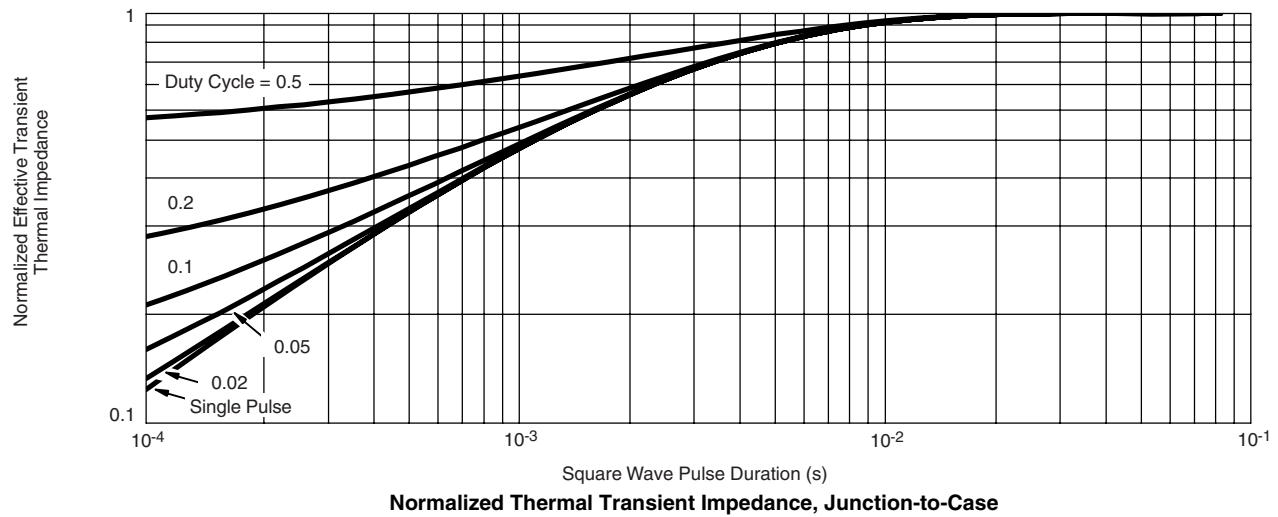
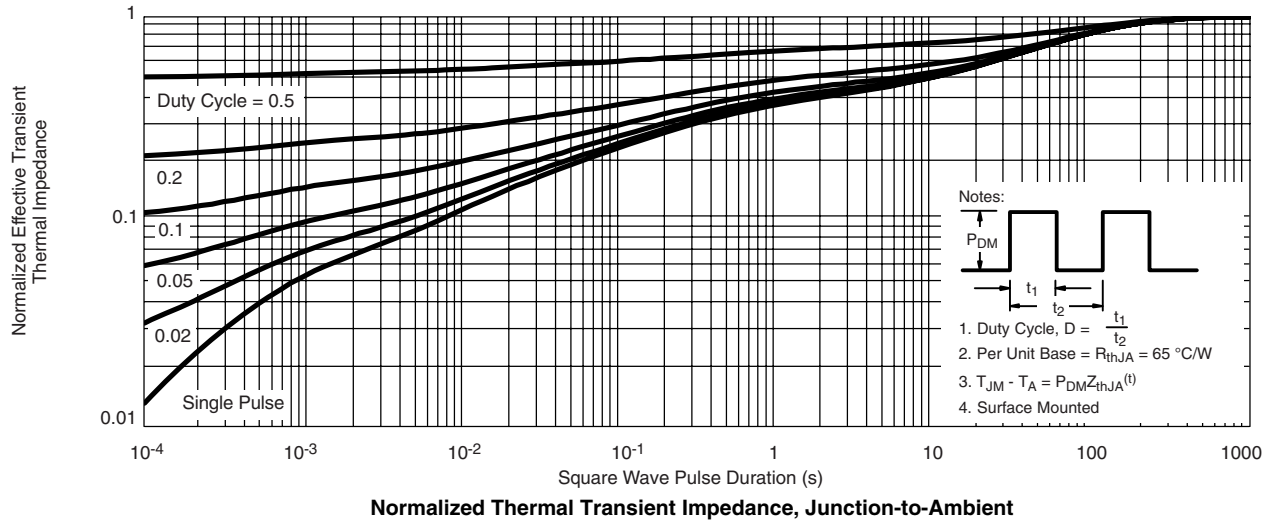

Vishay Siliconix maintains worldwide manufacturing capability. Products may be manufactured at one of several qualified locations. Reliability data for Silicon Technology and Package Reliability represent a composite of all qualified locations. For related documents such as package/tape drawings, part marking, and reliability data, see <http://www.vishay.com/ppg?73603>.



Disclaimer

ALL PRODUCT, PRODUCT SPECIFICATIONS AND DATA ARE SUBJECT TO CHANGE WITHOUT NOTICE TO IMPROVE RELIABILITY, FUNCTION OR DESIGN OR OTHERWISE.

Vishay Intertechnology, Inc., its affiliates, agents, and employees, and all persons acting on its or their behalf (collectively, "Vishay"), disclaim any and all liability for any errors, inaccuracies or incompleteness contained in any datasheet or in any other disclosure relating to any product.

Vishay makes no warranty, representation or guarantee regarding the suitability of the products for any particular purpose or the continuing production of any product. To the maximum extent permitted by applicable law, Vishay disclaims (i) any and all liability arising out of the application or use of any product, (ii) any and all liability, including without limitation special, consequential or incidental damages, and (iii) any and all implied warranties, including warranties of fitness for particular purpose, non-infringement and merchantability.

Statements regarding the suitability of products for certain types of applications are based on Vishay's knowledge of typical requirements that are often placed on Vishay products in generic applications. Such statements are not binding statements about the suitability of products for a particular application. It is the customer's responsibility to validate that a particular product with the properties described in the product specification is suitable for use in a particular application. Parameters provided in datasheets and / or specifications may vary in different applications and performance may vary over time. All operating parameters, including typical parameters, must be validated for each customer application by the customer's technical experts. Product specifications do not expand or otherwise modify Vishay's terms and conditions of purchase, including but not limited to the warranty expressed therein.

Except as expressly indicated in writing, Vishay products are not designed for use in medical, life-saving, or life-sustaining applications or for any other application in which the failure of the Vishay product could result in personal injury or death. Customers using or selling Vishay products not expressly indicated for use in such applications do so at their own risk. Please contact authorized Vishay personnel to obtain written terms and conditions regarding products designed for such applications.

No license, express or implied, by estoppel or otherwise, to any intellectual property rights is granted by this document or by any conduct of Vishay. Product names and markings noted herein may be trademarks of their respective owners.

X-ON Electronics

Largest Supplier of Electrical and Electronic Components

Click to view similar products for [MOSFET](#) category:

Click to view products by [Vishay](#) manufacturer:

Other Similar products are found below :

[614233C](#) [648584F](#) [MCH3443-TL-E](#) [MCH6422-TL-E](#) [FDPF9N50NZ](#) [FW216A-TL-2W](#) [FW231A-TL-E](#) [APT5010JVR](#) [NTNS3A92PZT5G](#)
[IRF100S201](#) [JANTX2N5237](#) [2SK2464-TL-E](#) [2SK3818-DL-E](#) [FCA20N60_F109](#) [FDZ595PZ](#) [STD6600NT4G](#) [FSS804-TL-E](#) [2SJ277-DL-E](#)
[2SK1691-DL-E](#) [2SK2545\(Q,T\)](#) [405094E](#) [423220D](#) [MCH6646-TL-E](#) [TPCC8103,L1Q\(CM](#) [367-8430-0972-503](#) [VN1206L](#) [424134F](#)
[026935X](#) [051075F](#) [SBVS138LT1G](#) [614234A](#) [715780A](#) [NTNS3166NZT5G](#) [751625C](#) [873612G](#) [IRF7380TRHR](#) [IPS70R2K0CEAKMA1](#)
[RJK60S3DPP-E0#T2](#) [RJK60S5DPK-M0#T0](#) [APT5010JVFR](#) [APT12031JFLL](#) [APT12040JVR](#) [DMN3404LQ-7](#) [NTE6400](#) [JANTX2N6796U](#)
[JANTX2N6784U](#) [JANTXV2N5416U4](#) [SQM110N05-06L-GE3](#) [SIHF35N60E-GE3](#) [2SK2614\(TE16L1,Q\)](#)