

E Series Power MOSFET With Fast Body Diode

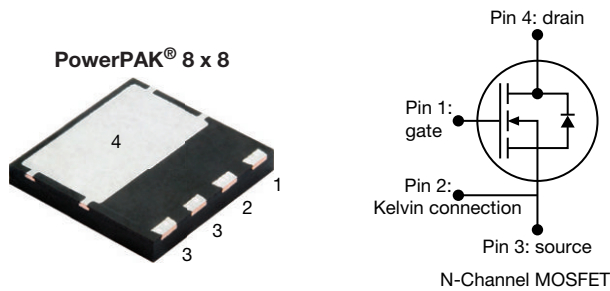

FEATURES

- Completely lead (Pb)-free device
- Low figure-of-merit (FOM) $R_{on} \times Q_g$
- Low input capacitance (C_{iss})
- Reduced switching and conduction losses
- Ultra low gate charge (Q_g)
- Avalanche energy rated (UIS)
- Kelvin connection for reduced gate noise
- Material categorization: for definitions of compliance please see www.vishay.com/doc?99912



RoHS
COMPLIANT
HALOGEN
FREE

PRODUCT SUMMARY

| | | |
|---|-----------------|-------|
| V_{DS} (V) at T_J max. | 650 | |
| $R_{DS(on)}$ typ. (Ω) at 25 °C | $V_{GS} = 10$ V | 0.087 |
| Q_g max. (nC) | 135 | |
| Q_{gs} (nC) | 17 | |
| Q_{gd} (nC) | 45 | |
| Configuration | Single | |

APPLICATIONS

- Server and telecom power supplies
- Switch mode power supplies (SMPS)
- Power factor correction power supplies (PFC)
- Lighting
 - High-intensity discharge (HID)
 - Fluorescent ballast lighting
- Industrial
 - Welding
 - Induction heating
 - Motor drives
 - Battery chargers
 - Renewable energy
 - Solar (PV inverters)

ORDERING INFORMATION

| | |
|---------------------------------|--------------------|
| Package | PowerPAK 8 x 8 |
| Lead (Pb)-free and halogen-free | SiHH27N60EF-T1-GE3 |

ABSOLUTE MAXIMUM RATINGS ($T_C = 25$ °C, unless otherwise noted)

| PARAMETER | SYMBOL | LIMIT | UNIT | |
|--|------------------|----------------|------|------|
| Drain-source voltage | V_{DS} | 600 | V | |
| Gate-source voltage | V_{GS} | ± 30 | | |
| Continuous drain current ($T_J = 150$ °C) | V_{GS} at 10 V | $T_C = 25$ °C | 29 | A |
| | | $T_C = 100$ °C | 18 | |
| Pulsed drain current ^a | I_{DM} | 73 | | |
| Linear derating factor | | 1.6 | W/°C | |
| Single pulse avalanche energy ^b | E_{AS} | 353 | mJ | |
| Maximum power dissipation | P_D | 202 | W | |
| Operating junction and storage temperature range | T_J, T_{stg} | -55 to +150 | °C | |
| Drain-source voltage slope | dV/dt | $T_J = 125$ °C | 100 | V/ns |
| Reverse diode dV/dt ^c | | 11 | | |

Notes

- Repetitive rating; pulse width limited by maximum junction temperature
- $V_{DD} = 140$ V, starting $T_J = 25$ °C, $L = 28.2$ mH, $R_g = 25$ Ω , $I_{AS} = 5$ A
- $I_{SD} \leq I_D$, $dI/dt = 100$ A/ μ s, starting $T_J = 25$ °C



| THERMAL RESISTANCE RATINGS | | | | |
|----------------------------------|------------|------|------|------|
| PARAMETER | SYMBOL | TYP. | MAX. | UNIT |
| Maximum junction-to-ambient | R_{thJA} | 38 | 50 | °C/W |
| Maximum junction-to-case (drain) | R_{thJC} | 0.48 | 0.62 | |

| SPECIFICATIONS ($T_J = 25\text{ }^\circ\text{C}$, unless otherwise noted) | | | | | | | |
|---|---------------------|---|--|------|-------|-----------|---------------|
| PARAMETER | SYMBOL | TEST CONDITIONS | | MIN. | TYP. | MAX. | UNIT |
| Static | | | | | | | |
| Drain-source breakdown voltage | V_{DS} | $V_{GS} = 0\text{ V}, I_D = 250\text{ }\mu\text{A}$ | | 600 | - | - | V |
| V_{DS} temperature coefficient | $\Delta V_{DS}/T_J$ | Reference to $25\text{ }^\circ\text{C}, I_D = 10\text{ mA}$ | | - | 0.55 | - | V/°C |
| Gate-source threshold voltage (N) | $V_{GS(th)}$ | $V_{DS} = V_{GS}, I_D = 250\text{ }\mu\text{A}$ | | 2.0 | - | 4.0 | V |
| Gate-source leakage | I_{GSS} | $V_{GS} = \pm 20\text{ V}$ | | - | - | ± 100 | nA |
| | | $V_{GS} = \pm 30\text{ V}$ | | - | - | ± 1 | μA |
| Zero gate voltage drain current | I_{DSS} | $V_{DS} = 480\text{ V}, V_{GS} = 0\text{ V}$ | | - | - | 1 | μA |
| | | $V_{DS} = 480\text{ V}, V_{GS} = 0\text{ V}, T_J = 125\text{ }^\circ\text{C}$ | | - | - | 500 | |
| Drain-source on-state resistance | $R_{DS(on)}$ | $V_{GS} = 10\text{ V}$ | $I_D = 13.5\text{ A}$ | - | 0.087 | 0.100 | Ω |
| Forward transconductance | g_{fs} | $V_{DS} = 30\text{ V}, I_D = 13.5\text{ A}$ | | - | 9.6 | - | S |
| Dynamic | | | | | | | |
| Input capacitance | C_{iss} | $V_{GS} = 0\text{ V},$ $V_{DS} = 100\text{ V},$ $f = 1\text{ MHz}$ | | - | 2609 | - | pF |
| Output capacitance | C_{oss} | | | - | 125 | - | |
| Reverse transfer capacitance | C_{rss} | | | - | 5 | - | |
| Effective output capacitance, energy related ^a | $C_{o(er)}$ | | | - | 86 | - | |
| Effective output capacitance, time related ^b | $C_{o(tr)}$ | $V_{DS} = 0\text{ V to } 480\text{ V}, V_{GS} = 0\text{ V}$ | | - | 449 | - | |
| Total gate charge | Q_g | $V_{GS} = 10\text{ V}$ | $I_D = 13.5\text{ A}, V_{DS} = 480\text{ V}$ | - | 90 | 135 | nC |
| Gate-source charge | Q_{gs} | | | - | 17 | - | |
| Gate-drain charge | Q_{gd} | | | - | 45 | - | |
| Turn-on delay time | $t_{d(on)}$ | $V_{DD} = 480\text{ V}, I_D = 13.5\text{ A},$ $V_{GS} = 10\text{ V}, R_g = 9.1\text{ }\Omega$ | | - | 28 | 56 | ns |
| Rise time | t_r | | | - | 63 | 95 | |
| Turn-off delay time | $t_{d(off)}$ | | | - | 101 | 152 | |
| Fall time | t_f | | | - | 59 | 89 | |
| Gate input resistance | R_g | $f = 1\text{ MHz}$ | | 0.3 | 0.6 | 1.2 | Ω |
| Drain-Source Body Diode Characteristics | | | | | | | |
| Continuous source-drain diode current | I_S | MOSFET symbol showing the integral reverse p - n junction diode  | | - | - | 29 | A |
| Pulsed diode forward current | I_{SM} | | | - | - | 73 | |
| Diode forward voltage | V_{SD} | $T_J = 25\text{ }^\circ\text{C}, I_S = 13.5\text{ A}, V_{GS} = 0\text{ V}$ | | - | 0.9 | 1.2 | V |
| Reverse recovery time | t_{rr} | $T_J = 25\text{ }^\circ\text{C}, I_F = I_S = 13.5\text{ A},$ $di/dt = 100\text{ A}/\mu\text{s}, V_R = 25\text{ V}$ | | - | 144 | 288 | ns |
| Reverse recovery charge | Q_{rr} | | | - | 0.9 | 1.8 | μC |
| Reverse recovery current | I_{RRM} | | | - | 12 | - | A |

Notes

- a. $C_{oss(er)}$ is a fixed capacitance that gives the same energy as C_{oss} while V_{DS} is rising from 0 % to 80 % V_{DS}
- b. $C_{oss(tr)}$ is a fixed capacitance that gives the same charging time as C_{oss} while V_{DS} is rising from 0 % to 80 % V_{DS}



TYPICAL CHARACTERISTICS (25 °C, unless otherwise noted)

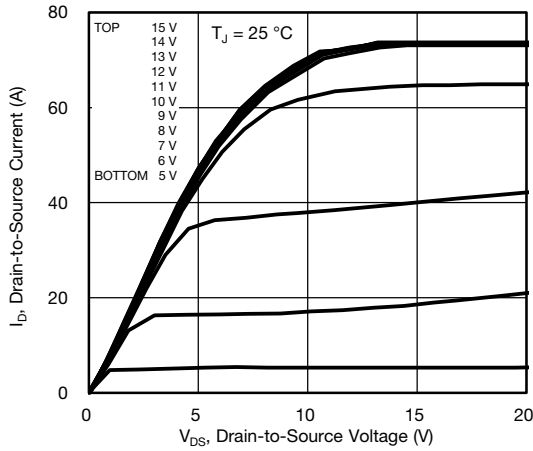

Fig. 1 - Typical Output Characteristics

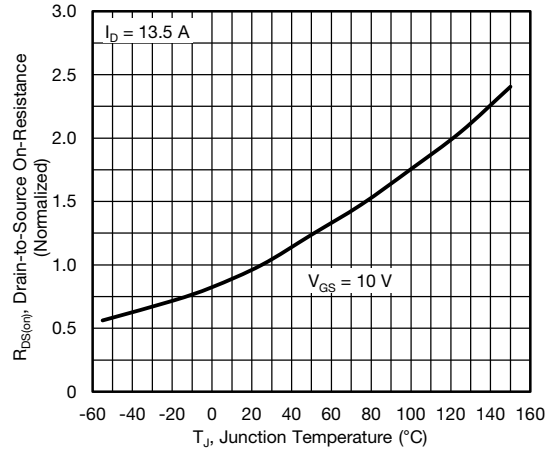

Fig. 4 - Normalized On-Resistance vs. Temperature

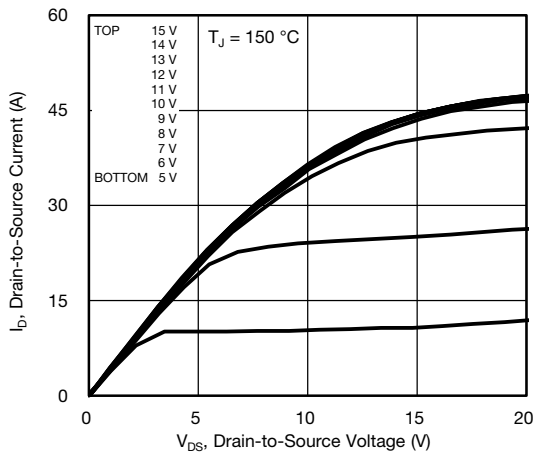

Fig. 2 - Typical Output Characteristics

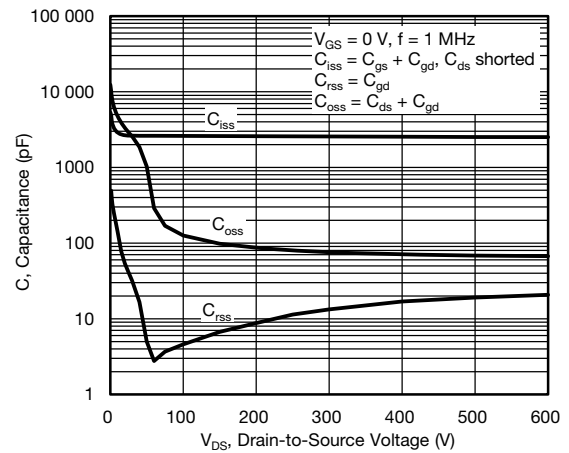

Fig. 5 - Typical Capacitance vs. Drain-to-Source Voltage

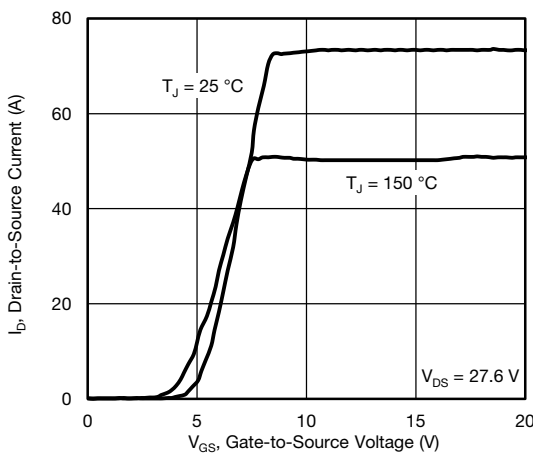

Fig. 3 - Typical Transfer Characteristics

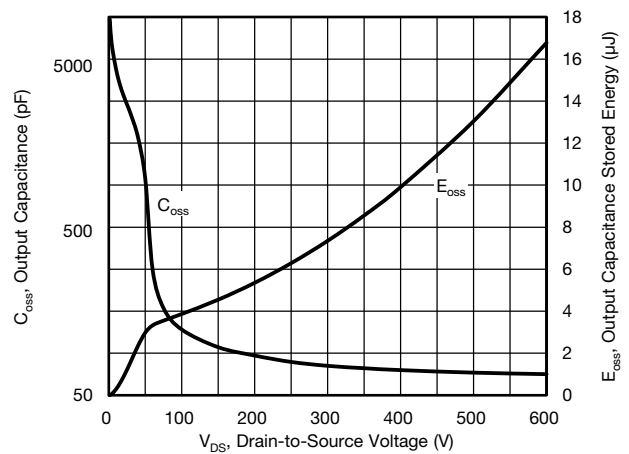

Fig. 6 - Coss and Eoss vs. VDS

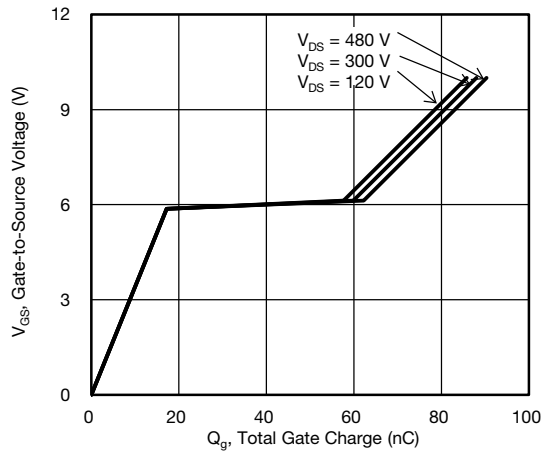

Fig. 7 - Typical Gate Charge vs. Gate-to-Source Voltage

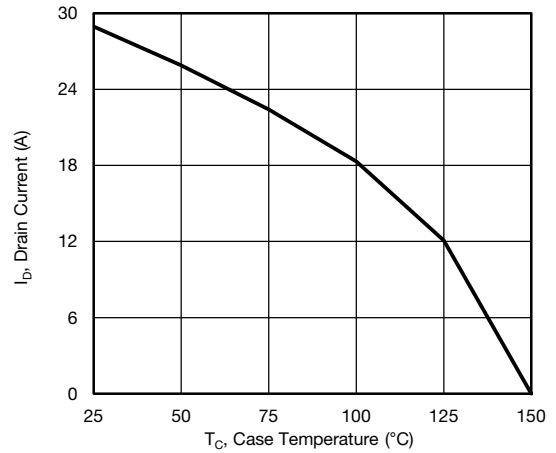

Fig. 10 - Maximum Drain Current vs. Case Temperature

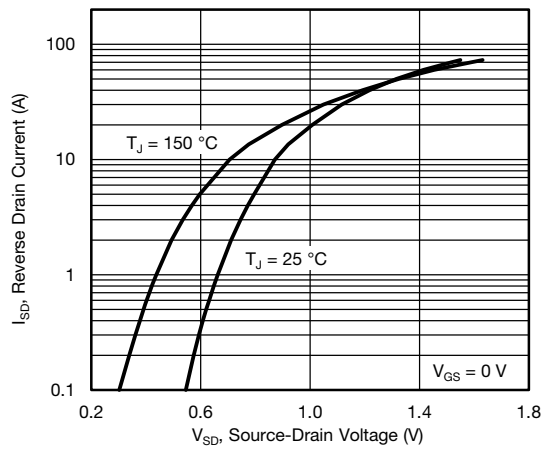

Fig. 8 - Typical Source-Drain Diode Forward Voltage

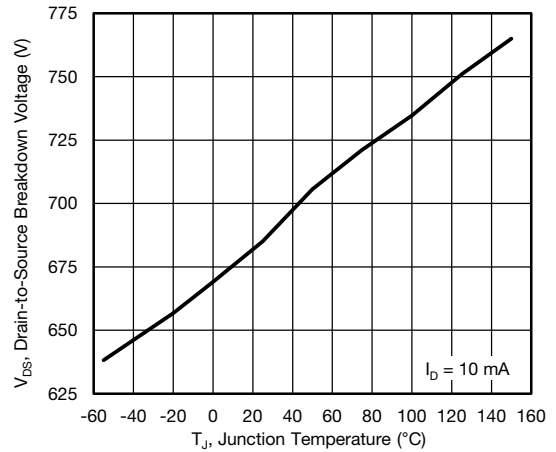

Fig. 11 - Temperature vs. Drain-to-Source Voltage

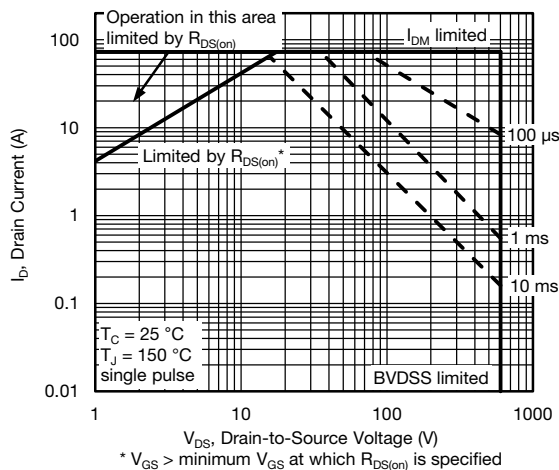

Fig. 9 - Maximum Safe Operating Area

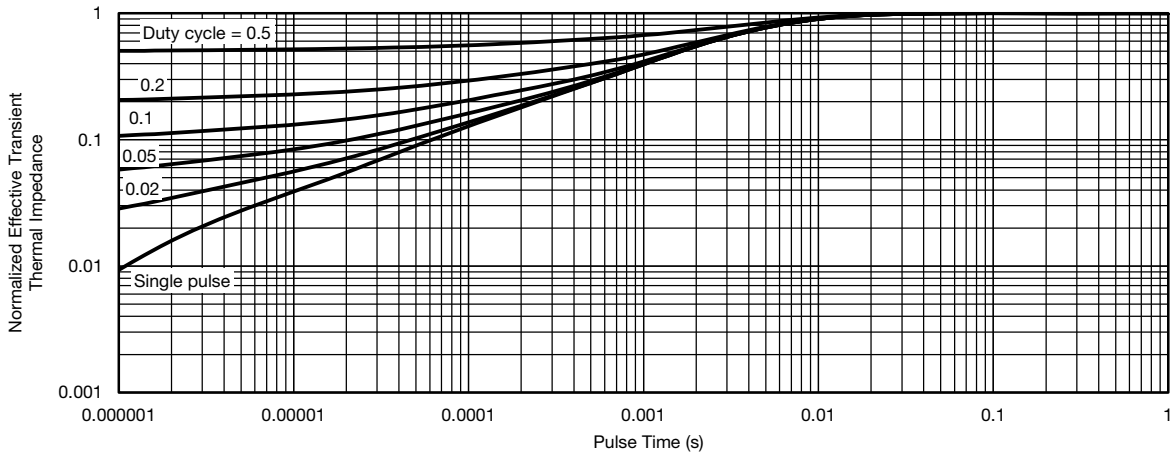

Fig. 12 - Normalized Thermal Transient Impedance, Junction-to-Case

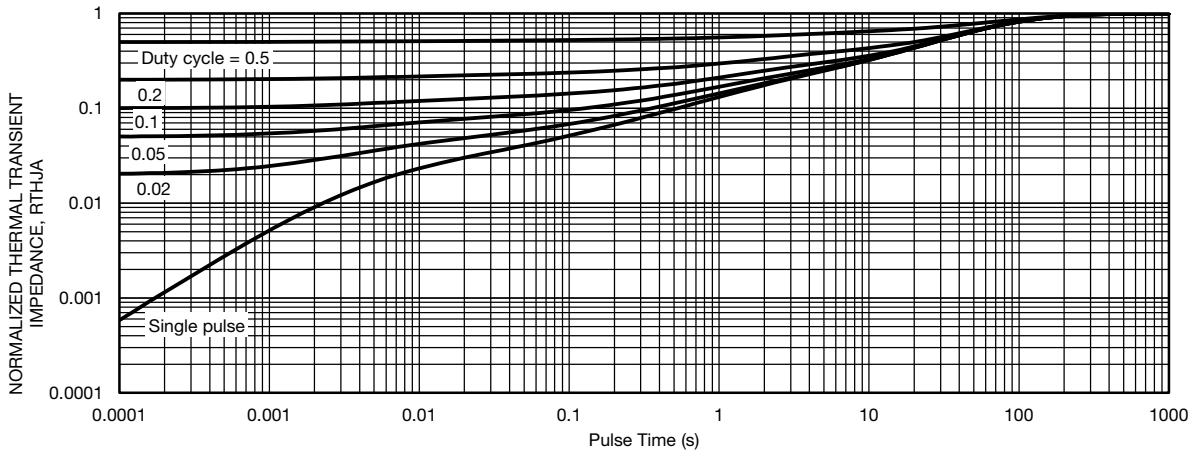

Fig. 13 - Normalized Thermal Transient Impedance, Junction-to-Ambient

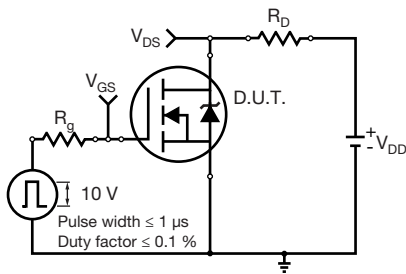

Fig. 14 - Switching Time Test Circuit

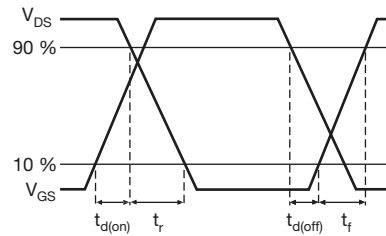

Fig. 15 - Switching Time Waveforms

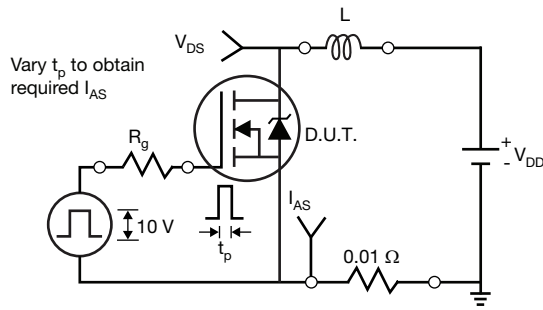

Fig. 16 - Unclamped Inductive Test Circuit

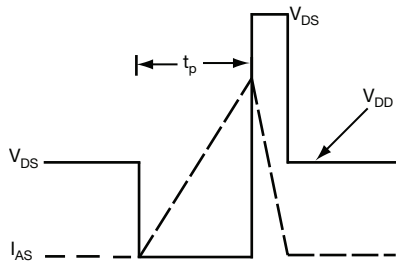

Fig. 17 - Unclamped Inductive Waveforms

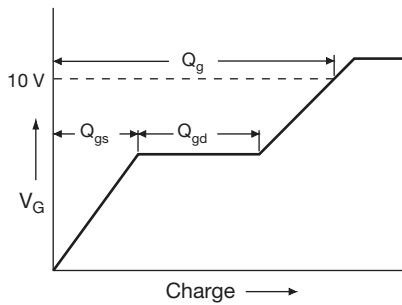

Fig. 18 - Basic Gate Charge Waveform

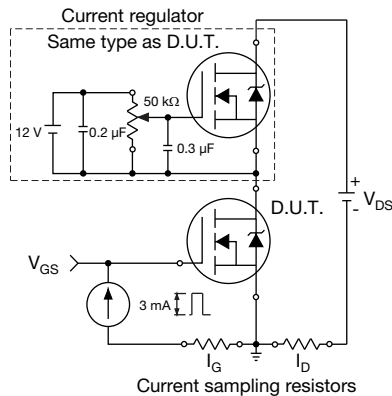

Fig. 19 - Gate Charge Test Circuit

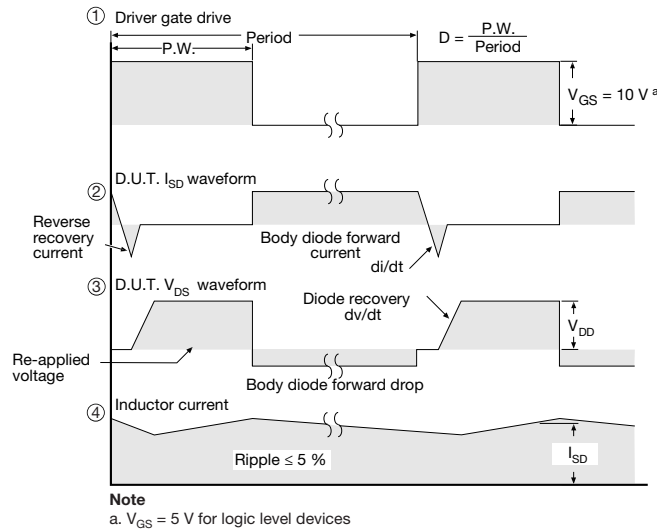
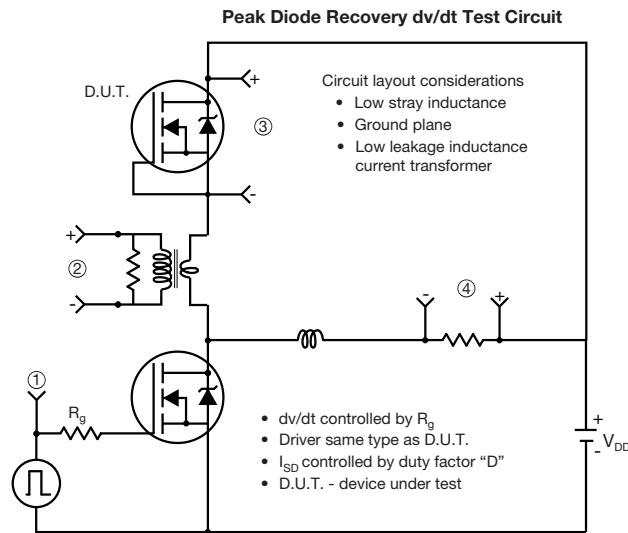
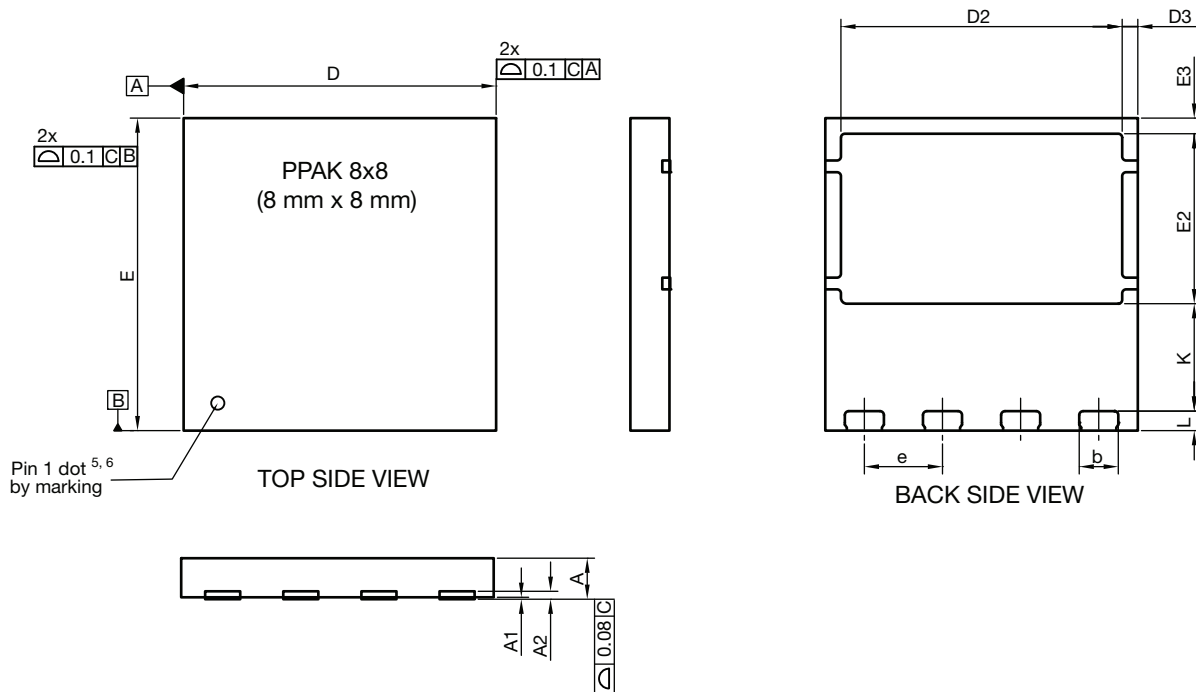

Fig. 20 - For N-Channel

Vishay Siliconix maintains worldwide manufacturing capability. Products may be manufactured at one of several qualified locations. Reliability data for Silicon Technology and Package Reliability represent a composite of all qualified locations. For related documents such as package/tape drawings, part marking, and reliability data, see www.vishay.com/ppg?91985.

PowerPAK[®] 8 x 8 Case Outline

| DIM. | MILLIMETERS | | | INCHES | | |
|----------------|-------------|------|------|------------|-------|-------|
| | MIN. | NOM. | MAX. | MIN. | NOM. | MAX. |
| A ⁸ | 0.95 | 1.00 | 1.05 | 0.037 | 0.039 | 0.041 |
| A1 | 0.00 | - | 0.05 | 0.000 | - | 0.002 |
| A2 | 020 ref. | | | 0.008 ref. | | |
| b ⁴ | 0.95 | 1.00 | 1.05 | 0.037 | 0.039 | 0.041 |
| D | 7.90 | 8.00 | 8.10 | 0.311 | 0.315 | 0.319 |
| D2 | 7.10 | 7.20 | 7.30 | 0.280 | 0.283 | 0.287 |
| D3 | 0.40 BSC | | | 0.016 BSC | | |
| e | 2.00 BSC | | | 0.079 BSC | | |
| E | 7.90 | 8.00 | 8.10 | 0.311 | 0.315 | 0.319 |
| E2 | 4.30 | 4.35 | 4.40 | 0.169 | 0.171 | 0.173 |
| E3 | 0.40 BSC | | | 0.016 BSC | | |
| K | 2.75 BSC | | | 0.108 BSC | | |
| L | 0.45 | 0.50 | 0.55 | 0.018 | 0.020 | 0.022 |
| N ³ | 8 | | | 8 | | |

Notes

1. Use millimeters as the primary measurement.
2. Dimensioning and tolerances conform to ASME Y14.5 M - 1994.
3. N is the number of terminals.
4. Package warpage max. 0.08 mm.
5. The pin 1 identifier must be existed on the top surface of the package by using indentation mark or other feature of package body.
6. Exact shape and size of this feature is optional.

ECN: T15-0225-Rev. A, 18-May-15
 DWG: 6041



Recommended Minimum PADs for PowerPAK[®] 8 mm x 8 mm



Dimensions in millimeters



Disclaimer

ALL PRODUCT, PRODUCT SPECIFICATIONS AND DATA ARE SUBJECT TO CHANGE WITHOUT NOTICE TO IMPROVE RELIABILITY, FUNCTION OR DESIGN OR OTHERWISE.

Vishay Intertechnology, Inc., its affiliates, agents, and employees, and all persons acting on its or their behalf (collectively, "Vishay"), disclaim any and all liability for any errors, inaccuracies or incompleteness contained in any datasheet or in any other disclosure relating to any product.

Vishay makes no warranty, representation or guarantee regarding the suitability of the products for any particular purpose or the continuing production of any product. To the maximum extent permitted by applicable law, Vishay disclaims (i) any and all liability arising out of the application or use of any product, (ii) any and all liability, including without limitation special, consequential or incidental damages, and (iii) any and all implied warranties, including warranties of fitness for particular purpose, non-infringement and merchantability.

Statements regarding the suitability of products for certain types of applications are based on Vishay's knowledge of typical requirements that are often placed on Vishay products in generic applications. Such statements are not binding statements about the suitability of products for a particular application. It is the customer's responsibility to validate that a particular product with the properties described in the product specification is suitable for use in a particular application. Parameters provided in datasheets and / or specifications may vary in different applications and performance may vary over time. All operating parameters, including typical parameters, must be validated for each customer application by the customer's technical experts. Product specifications do not expand or otherwise modify Vishay's terms and conditions of purchase, including but not limited to the warranty expressed therein.

Except as expressly indicated in writing, Vishay products are not designed for use in medical, life-saving, or life-sustaining applications or for any other application in which the failure of the Vishay product could result in personal injury or death. Customers using or selling Vishay products not expressly indicated for use in such applications do so at their own risk. Please contact authorized Vishay personnel to obtain written terms and conditions regarding products designed for such applications.

No license, express or implied, by estoppel or otherwise, to any intellectual property rights is granted by this document or by any conduct of Vishay. Product names and markings noted herein may be trademarks of their respective owners.

X-ON Electronics

Largest Supplier of Electrical and Electronic Components

Click to view similar products for [MOSFET](#) category:

Click to view products by [Vishay](#) manufacturer:

Other Similar products are found below :

[614233C](#) [648584F](#) [IRFD120](#) [JANTX2N5237](#) [2N7000](#) [FCA20N60_F109](#) [FDZ595PZ](#) [2SK2545\(Q,T\)](#) [405094E](#) [423220D](#)
[TPCC8103,L1Q\(CM](#) [MIC4420CM-TR](#) [VN1206L](#) [614234A](#) [715780A](#) [NTNS3166NZT5G](#) [SSM6J414TU,LF\(T](#) [751625C](#)
[IPS70R2K0CEAKMA1](#) [BUK954R8-60E](#) [DMN3404LQ-7](#) [NTE6400](#) [SQJ402EP-T1-GE3](#) [2SK2614\(TE16L1,Q\)](#) [2N7002KW-FAI](#)
[DMN1017UCP3-7](#) [EFC2J004NUZTDG](#) [ECH8691-TL-W](#) [FCAB21350L1](#) [P85W28HP2F-7071](#) [DMN1053UCP4-7](#) [NTE221](#) [NTE2384](#)
[NTE2903](#) [NTE2941](#) [NTE2945](#) [NTE2946](#) [NTE2960](#) [NTE2967](#) [NTE2969](#) [NTE2976](#) [NTE455](#) [NTE6400A](#) [NTE2910](#) [NTE2916](#) [NTE2956](#)
[NTE2911](#) [TK10A80W,S4X\(S](#) [SSM6P69NU,LF](#) [DMP22D4UFO-7B](#)