



Demo Board User Manual for SiP12109 (4 A) and SiP12110 (6 A), 4.5 V to 15 V Input Synchronous Buck Regulators

THE CHIP

PRODUCT SUMMARY SiP12109DMP-T1-GE4	
Input Voltage Range	4.5 V to 15 V
Output Voltage Range	0.6 V to 5.5 V
Operating Frequency	400 kHz to 1.5 MHz
Continuous Output Current	4 A
Package	QFN16 3 mm x 3 mm

PRODUCT SUMMARY SiP12110DMP-T1-GE4	
Input Voltage Range	4.5 V to 15 V
Output Voltage Range	0.6 V to 5.5 V
Operating Frequency	400 kHz to 1.5 MHz
Continuous Output Current	6 A
Package	QFN16 3 mm x 3 mm

DESCRIPTION

The SiP12109 and SiP12110 are high frequency current-mode constant-on-time (CM-COT) synchronous buck regulator with integrated high-side and low-side power MOSFETs. The SiP12109 is capable of 4 A continuous current and the SiP12110 is capable of 6 A. These regulators produce an adjustable output voltage down to 0.6 V from 4.5 V to 15 V input rail to accommodate a variety of applications, including computing, consumer electronics, telecom, and industrial.

The CM-COT architecture delivers ultra-fast transient response with minimum output capacitance and tight ripple regulation at very light load. The parts are stable with any capacitor type and no ESR network is required for loop stability. The devices also incorporate a power saving scheme that significantly increases light load efficiency. The regulator integrates a full protection feature set, including output overvoltage protection (OVP), output under voltage protection (UVP) and thermal shutdown (OTP). It also has UVLO for the input rail and an internal soft-start. The SiP12109 is available in lead (Pb)-free power enhanced 3 mm x 3 mm QFN-16 package.

FEATURES

- 4.5 V to 15 V input voltage
- Adjustable output voltage down to 0.6 V
- 4 A (SiP12109)/6 A (SiP12110) continuous output current
- Selectable switching frequency from 400 kHz to 1.5 MHz with an external resistor
- 95 % peak efficiency
- Stable with any capacitor. No external ESR network required
- Ultrafast transient response
- Power saving scheme for increased light load efficiency
- ± 1 % accuracy of V_{OUT} setting
- Cycle-by-cycle current limit
- Fully protected with OTP, SCP, UVP, OVP
- PGOOD Indicator
- -40 °C to +125 °C operating junction temperature
- Output voltage tracking

APPLICATIONS

- Point of load regulation for low-power processors, network processors, DSPs, FPGAs, and ASICs
- Low voltage, distributed power architectures with 5 V or 12 V rails
- Computing, broadband, networking, LAN / WAN, optical, test, and measurement
- A/V, high density cards, storage, DSL, STB, DVR, DTV, industrial PC

ORDERING INFORMATION

DEMO BOARD PART NUMBER	MAX. OUTPUT CURRENT
SiP12109DB	4 A
SiP12110DB	6 A

SPECIFICATION

This reference board allows the end user to evaluate the SiP12109 or the SiP12110 chip for its features and all functionalities. It can also be a reference design for a user's application.

Input voltage (V): 4.5 to 15

Output voltage (V): 0.6 to 5

Output current (A): 0 to 4 for SiP12109, 0 to 6 for SiP12110



CONNECTION AND SIGNAL / TEST POINTS

Power Sockets

VIN (J1), GND (J4): Input voltage source with VIN to be positive. Connect to a 4.5 V to 16 V source that powers SiP12109.

VOU (J2), GND (J3): Output voltage with VOUT to be positive. Connect to a load that draws less than 4 A current.

SIGNAL AND TEST LEADS

EN (J5): When the pin is grounded the SiP12109 is disabled. A voltage above ~ 1.5 V will be seen as HI and enable the part allowing switching to occur.

PGD(J6): Is an open drain output and is pulled up with a 100 kΩ resistor to VIN. When FB or VOUT are within 25 percent of the set voltage this pin will go HI to indicate the output is okay.

POWER UP PROCEDURE

To turn-on the reference board, apply 12 V to VIN and another supply > 1.5 V to the EN pin J10. The board will come up in ECO power save mode with an output voltage preset to 1.2 V. This will allow much higher efficiency due to lower switching frequency at zero to very light loads. As the load increases the frequency will increase until the nominal set frequency (preset to ~ 1 MHz) is reached.

When applying higher than 12 V to the input it is recommended to install a RC snubber from LX to GND. There are place holders on the reference board R4 and C23 for the snubber. Values of 5.6 Ω and 0.39 nF are a reasonable starting point.

COMMON ADJUSTMENTS MADE TO THE REFERENCE BOARD OUTPUT VOLTAGE ADJUSTMENT

The evaluation board is configured for a 1.2 V output. If a different output voltage is needed, simply change the value of VOUT and solve for R11 based on the following formula:

R11 = R7 x (Vref / (VOUT - Vref)) = 5.11 kΩ x (0.6 V / (1.2 V - 0.6 V)) = 5.11 kΩ

CHANGING SWITCHING FREQUENCY

The following equation illustrates the relationship between ON-time, VIN, VOUT, and RON value:

TON = RON x K x (VOUT / VIN)

where K is a constant set internally. (K = 17 x 10^-12)

Once ON time is set, pseudo constant frequency is then determined by the following equation:

Fsw = D / TON = (VOUT / VIN) / (1 / VIN x RON x K) = (VOUT / (RON x K))

OUTPUT RIPPLE VOLTAGE

Output ripple voltage is measured at the a tip and barrel measurement across COUT or use the probe jack located at VOUT. Typically output ripple voltage is set to 3 % to 5% of the output voltage, but an all ceramic output solution can bring output ripple voltage to a much lower level since the ESR of ceramics is very small. This can cause stability issues with other COT controllers, which require a minimum ripple voltage, but not with the SIP12109 which uses current mode control. The SiP12109 can work with any type of output capacitors that suits your needs.

INDUCTOR SELECTION

Knowing VIN, VOUT, Fsw, full load current and choosing a ripple current (•I) that's between 20 % to 50 % of full load current we can calculate an inductor value.

L = (VIN - VOUT) x (VOUT / (Fsw x VIN x ΔI x IOUT max)) = (12 V - 1.2 V) x (1.2 / (1 x 10^6 x 12 V x 0.25 x 4 A)) = 1 μH

INPUT CAPACITORS

The input capacitors are chosen as a combination of bulk and ceramic capacitors, to satisfy cost, RMS current, ESR, input voltage ripple requirements and a source for instantaneous energy and filtering that the converter may require.

INDUCTORS

Other than the inductance the DCR and saturation current parameters are key values. The DCR causes an I^2R loss which will decrease the system efficiency and generate heat. The saturation current has to be higher than the maximum output current plus 1/2 the ripple current. In over current condition the inductor current may be very high. All this needs to be considered when selecting the inductor.

On this board Vishay IHLP-2525EZ series inductors are used to meet cost requirement and get better efficiency and utilizes a material that has incredible saturation levels compared to competing products.



OUTPUT CAPACITORS

Voltage rating, ESR, transient response, overall PCB area, and cost are requirements for selecting output capacitors. The types of capacitors and their general advantages and disadvantages are covered next.

Electrolytics have high ESR, dry out over time so ripple current rating must be examined and have slower transient response, but are fairly inexpensive for the amount of overall capacitance.

Tantalums can come in low ESR varieties and high capacitance value for its overall size, but they fail short when damaged and also have slower transient response.

Ceramics have very low ESR, fast transient response, and overall small size, but are expensive and come in low capacitance values compared to the others above.

The SiP12109 is an advanced current mode constant on time controller which eliminates the minimum output ripple voltage required by voltage mode based controllers and can operate stably with an all ceramic output capacitance.

SOFT START

The external soft start cap is charged via a 5 μ A current source. Using this formula we can calculate the soft start time

$$SS = (C_{ext} \times 0.8 V) / 5 \mu A$$

Using a 10 nF cap we get ~ 1 ms typical soft start time which is dependent on V_{OUT} level also.

REFERENCE BOARD PHOTOS

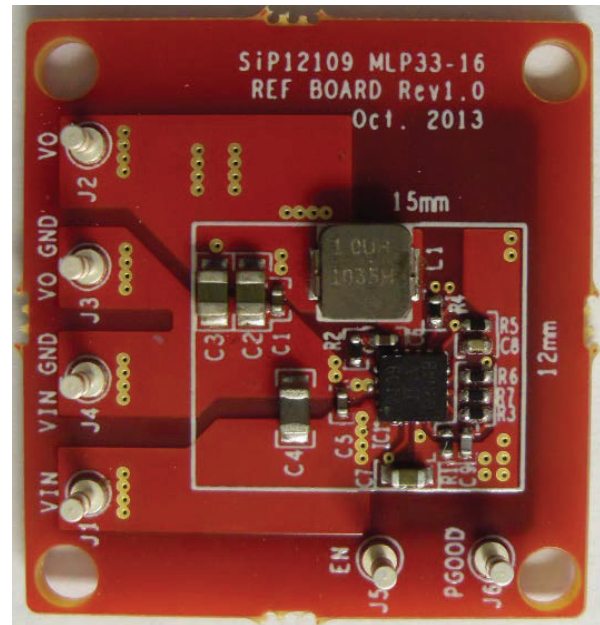

Fig. 1 - Top of the PCB

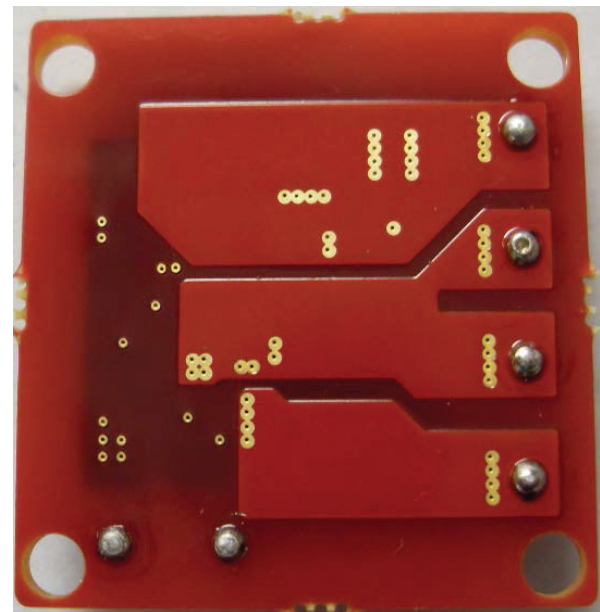

Fig. 2 - Bottom of the PCB



PCB LAYOUT

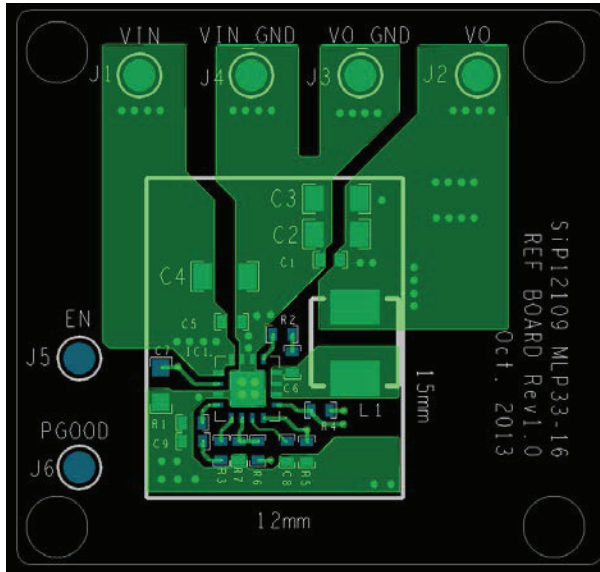

Fig. 3 - Top Layer

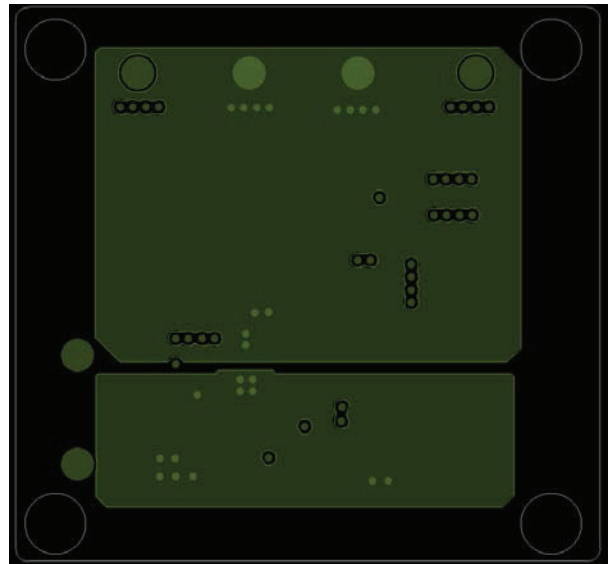

Fig. 5 - Inner Layer 1

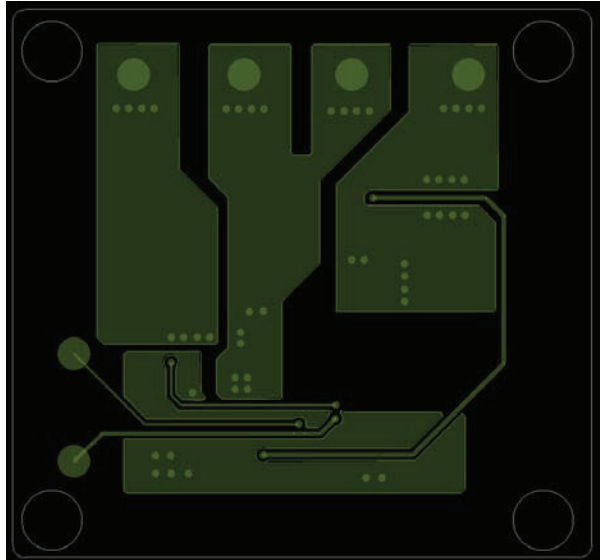

Fig. 4 - Inner Layer 2

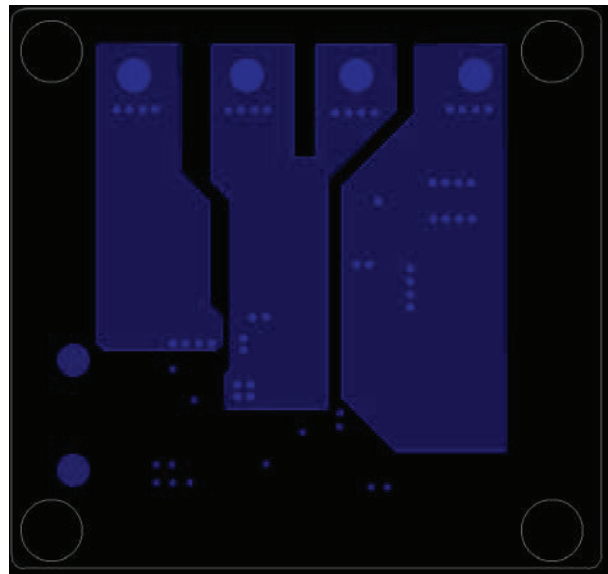
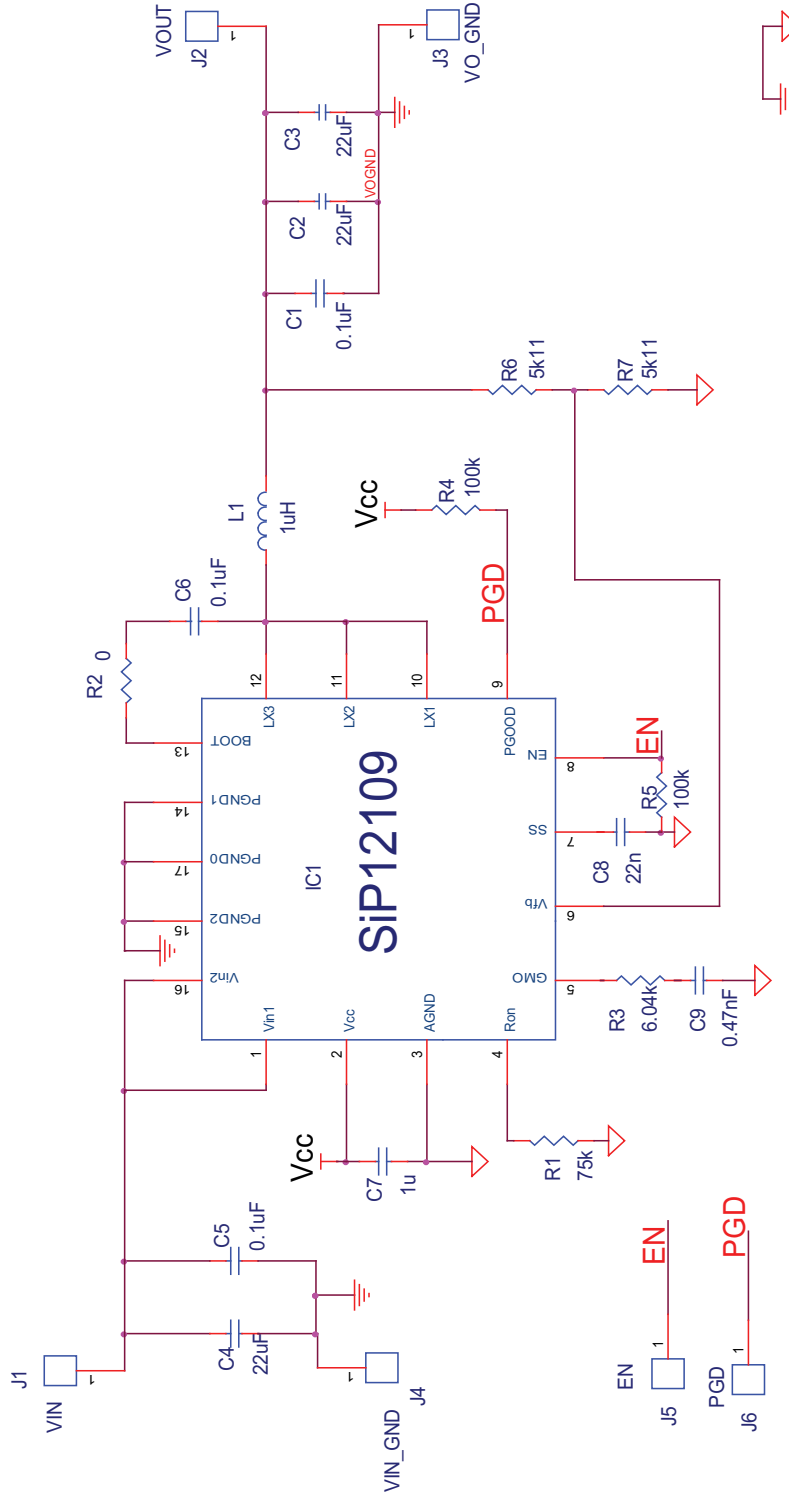

Fig. 6 - Bottom Layer



SCHEMATIC OF DEMO BOARD





BILL of MATERIAL							
ITEM	QTY	REFERENCE	PCB FOOTPRINT	VALUE	VOLTAGE	DESCRIPTION	PART NUMBER
1	3	C1, C5, C6	C0402-TDK	0.1 μ F	35 V	GMK105BJ104KV-F	Taiyo Yuden
2	2	C2, C3	C0805-TDK	22 μ F	10 V	LMK212BJ226MG-T	Taiyo Yuden
	1	C4	C0805-TDK	22 μ F	35 V	C2012X5R1V226M125AC	TDK
3	1	C7	C0603-TDK	1 μ F	25 V	TMK107BJ105KA-T	Taiyo Yuden
4	1	C8	C0402-TDK	22 nF	50 V	CGA2B3X5R1H223K050BB	TDK
5	1	C9	C0402-TDK	0.47 nF	50 V	C1005C0G1H471J050BA	TDK
6	1	IC1	MLP44-16	SiP12109	-	SiP12109	Vishay
7	6	J1, J2, J3, J4, J5, J6	TP30	V _{IN} , V _{OUT} , V _{O_GND} , V _{IN_GND} , EN, PGD	-	5002K-ND	Keystone
8	1	L1	IHLP-1616	1 μ H	-	IHLP1616BZER1R0M11	Vishay
9	1	R1	R0402-Vishay	75 k Ω	-	CRCW040275K0FKEDHP	Vishay
10	1	R2	R0402-Vishay	0	-	RCG04020000Z0ED	Vishay
11	1	R3	R0402-Vishay	6.04 k Ω	-	CRCW04026K04FKED	Vishay
12	2	R4, R5	R0402-Vishay	100 k Ω	-	CRCW0402100KFKED	Vishay
13	2	R6, R7	R0402-Vishay	5.11 k Ω	-	CRCW04025K11FKED	Vishay

Vishay Siliconix maintains worldwide manufacturing capability. Products may be manufactured at one of several qualified locations. Reliability data for Silicon Technology and Package Reliability represent a composite of all qualified locations. For related documents such as package/tape drawings, part marking, and reliability data, see www.vishay.com/ppg?64324.

X-ON Electronics

Largest Supplier of Electrical and Electronic Components

Click to view similar products for [Power Management IC Development Tools](#) category:

Click to view products by [Vishay](#) manufacturer:

Other Similar products are found below :

[EVAL-ADM1168LQEBZ](#) [EVB-EP5348UI](#) [MIC23451-AAAYFL EV](#) [MIC5281YMME EV](#) [DA9063-EVAL](#) [ADP122-3.3-EVALZ](#) [ADP130-0.8-EVALZ](#) [ADP130-1.2-EVALZ](#) [ADP130-1.5-EVALZ](#) [ADP130-1.8-EVALZ](#) [ADP1714-3.3-EVALZ](#) [ADP1716-2.5-EVALZ](#) [ADP1740-1.5-EVALZ](#) [ADP1752-1.5-EVALZ](#) [ADP1828LC-EVALZ](#) [ADP1870-0.3-EVALZ](#) [ADP1871-0.6-EVALZ](#) [ADP1873-0.6-EVALZ](#) [ADP1874-0.3-EVALZ](#) [ADP1882-1.0-EVALZ](#) [ADP199CB-EVALZ](#) [ADP2102-1.25-EVALZ](#) [ADP2102-1.875EVALZ](#) [ADP2102-1.8-EVALZ](#) [ADP2102-2-EVALZ](#) [ADP2102-3-EVALZ](#) [ADP2102-4-EVALZ](#) [ADP2106-1.8-EVALZ](#) [ADP2147CB-110EVALZ](#) [AS3606-DB](#) [BQ24010EVM](#) [BQ24075TEVM](#) [BQ24155EVM](#) [BQ24157EVM-697](#) [BQ24160EVM-742](#) [BQ24296MEVM-655](#) [BQ25010EVM](#) [BQ3055EVM](#) [NCV891330PD50GEVB](#) [ISLUSBI2CKIT1Z](#) [LM2744EVAL](#) [LM2854EVAL](#) [LM3658SD-AEV/NOPB](#) [LM3658SDEV/NOPB](#) [LM3691TL-1.8EV/NOPB](#) [LM4510SDEV/NOPB](#) [LM5033SD-EVAL](#) [LP38512TS-1.8EV](#) [EVAL-ADM1186-1MBZ](#) [EVAL-ADM1186-2MBZ](#)