

Surface Mount TRANSZORB® Transient Voltage Suppressors



SMA (DO-214AC)

PRIMARY CHARACTERISTICS	
V _{BR} uni-directional	6.40 V to 231 V
V _{BR} bi-directional	6.40 V to 231 V
V _{WM}	5.0 V to 188 V
P _{PPM}	400 W, 300 W
I _{FSM}	40 A
T _J max.	150 °C
Polarity	Uni-directional, bi-directional
Package	SMA (DO-214AC)

DEVICES FOR BI-DIRECTION APPLICATIONS

For bi-directional use CA suffix (e.g. SMAJ10CA).
Electrical characteristics apply in both directions.

FEATURES

- Low profile package
- Ideal for automated placement
- Glass passivated chip junction
- Available in uni-directional and bi-directional
- 400 W peak pulse power capability with a 10/1000 μs waveform, repetitive rate (duty cycle): 0.01 % (300 W above 78 V)
- Excellent clamping capability
- Very fast response time
- Low incremental surge resistance
- Meets MSL level 1, per J-STD-020, LF maximum peak of 260 °C
- AEC-Q101 qualified available
- Automotive ordering code: base P/NHE3 or P/NHM3
- Material categorization: for definitions of compliance please see www.vishay.com/doc?99912



RoHS
COMPLIANT
HALOGEN
FREE
Available

TYPICAL APPLICATIONS

Use in sensitive electronics protection against voltage transients induced by inductive load switching and lighting on ICs, MOSFET, signal lines of sensor units for consumer, computer, industrial, automotive, and telecommunication.

MECHANICAL DATA

Case: SMA (DO-214AC)

Molding compound meets UL 94 V-0 flammability rating

Base P/N-E3 - RoHS-compliant, commercial grade

Base P/N-M3 - halogen-free, RoHS-compliant, commercial grade

Base P/NHE3_X - RoHS-compliant and AEC-Q101 qualified

Base P/NHM3_X - halogen-free, RoHS-compliant, and AEC-Q101 qualified

("_X" denotes revision code e.g. A, B, ...)

Terminals: matte tin plated leads, solderable per J-STD-002 and JESD 22-B102

E3, M3, HE3, and HM3 suffix meets JESD 201 class 2 whisker test

Polarity: for uni-directional types the band denotes cathode end, no marking on bi-directional types

MAXIMUM RATINGS (T _A = 25 °C unless otherwise noted)			
PARAMETER	SYMBOL	VALUE	UNIT
Peak pulse power dissipation with a 10/1000 μs waveform ⁽¹⁾⁽²⁾ (fig. 1)	P _{PPM}	400	W
Peak pulse current with a waveform ⁽¹⁾	I _{PPM}	See next table	A
Peak forward surge current 8.3 ms single half sine-wave uni-directional only ⁽²⁾	I _{FSM}	40	A
Operating junction and storage temperature range	T _J , T _{STG}	-55 to +150	°C

Notes

⁽¹⁾ Non-repetitive current pulse, per fig. 3 and derated above T_A = 25 °C per fig. 2. Rating is 300 W above 78 V

⁽²⁾ Mounted on 0.2" x 0.2" (5.0 mm x 5.0 mm) copper pads to each terminal



ELECTRICAL CHARACTERISTICS (T _A = 25 °C unless otherwise noted)									
DEVICE TYPE	DEVICE MARKING CODE		BREAKDOWN VOLTAGE V _{BR} AT I _T (1) (V)		TEST CURRENT I _T (mA)	STAND-OFF VOLTAGE V _{WM} (V)	MAXIMUM REVERSE LEAKAGE AT V _{WM} I _D (μA) (3)	MAXIMUM PEAK PULSE SURGE CURRENT I _{PPM} (A) (2)	MAXIMUM CLAMPING VOLTAGE AT I _{PPM} V _C (V)
	UNI	BI	MIN.	MAX.					
(+)SMAJ5.0A (5)	AE	WE	6.40	7.07	10	5.0	800	43.5	9.2
(+)SMAJ6.0A	AG	WG	6.67	7.37	10	6.0	800	38.8	10.3
(+)SMAJ6.5A	AK	WK	7.22	7.98	10	6.5	500	35.7	11.2
(+)SMAJ7.0A	AM	WM	7.78	8.60	10	7.0	200	33.3	12.0
(+)SMAJ7.5A	AP	WP	8.33	9.21	1.0	7.5	100	31.0	12.9
(+)SMAJ8.0A	AR	WR	8.89	9.83	1.0	8.0	50	29.4	13.6
(+)SMAJ8.5A	AT	WT	9.44	10.4	1.0	8.5	10	27.8	14.4
(+)SMAJ9.0A	AV	WV	10.0	11.1	1.0	9.0	5.0	26.0	15.4
(+)SMAJ10A	AX	WX	11.1	12.3	1.0	10	1.0	23.5	17.0
(+)SMAJ11A	AZ	WZ	12.2	13.5	1.0	11	1.0	22.0	18.2
(+)SMAJ12A	BE	XE	13.3	14.7	1.0	12	1.0	20.1	19.9
(+)SMAJ13A	BG	XG	14.4	15.9	1.0	13	1.0	18.6	21.5
(+)SMAJ14A	BK	XK	15.6	17.2	1.0	14	1.0	17.2	23.2
(+)SMAJ15A	BM	XM	16.7	18.5	1.0	15	1.0	16.4	24.4
(+)SMAJ16A	BP	XP	17.8	19.7	1.0	16	1.0	15.4	26.0
(+)SMAJ17A	BR	XR	18.9	20.9	1.0	17	1.0	14.5	27.6
(+)SMAJ18A	BT	XT	20.0	22.1	1.0	18	1.0	13.7	29.2
(+)SMAJ20A	BV	XV	22.2	24.5	1.0	20	1.0	12.3	32.4
(+)SMAJ22A	BX	XX	24.4	26.9	1.0	22	1.0	11.3	35.5
(+)SMAJ24A	BZ	XZ	26.7	29.5	1.0	24	1.0	10.3	38.9
(+)SMAJ26A	CE	YE	28.9	31.9	1.0	26	1.0	9.5	42.1
(+)SMAJ28A	CG	YG	31.1	34.4	1.0	28	1.0	8.8	45.4
(+)SMAJ30A	CK	YK	33.3	36.8	1.0	30	1.0	8.3	48.4
(+)SMAJ33A	CM	YM	36.7	40.6	1.0	33	1.0	7.5	53.3
(+)SMAJ36A	CP	YP	40.0	44.2	1.0	36	1.0	6.9	58.1
(+)SMAJ40A	CR	YR	44.4	49.1	1.0	40	1.0	6.2	64.5
(+)SMAJ43A	CT	YT	47.8	52.8	1.0	43	1.0	5.8	69.4
(+)SMAJ45A	CV	YV	50.0	55.3	1.0	45	1.0	5.5	72.7
(+)SMAJ48A	CX	YX	53.3	58.9	1.0	48	1.0	5.2	77.4
(+)SMAJ51A	CZ	YZ	56.7	62.7	1.0	51	1.0	4.9	82.4
(+)SMAJ54A	RE	ZE	60.0	66.3	1.0	54	1.0	4.6	87.1
(+)SMAJ58A	RG	ZG	64.4	71.2	1.0	58	1.0	4.3	93.6
(+)SMAJ60A	RK	ZK	66.7	73.7	1.0	60	1.0	4.1	96.8
(+)SMAJ64A	RM	ZM	71.1	78.6	1.0	64	1.0	3.9	103
(+)SMAJ70A	RP	ZP	77.8	86.0	1.0	70	1.0	3.5	113
(+)SMAJ75A	RR	ZR	83.3	92.1	1.0	75	1.0	3.3	121
(+)SMAJ78A	RT	ZT	86.7	95.8	1.0	78	1.0	3.2	126
(+)SMAJ85A	RV	ZV	94.4	104	1.0	85	1.0	2.2	137
(+)SMAJ90A	RX	ZX	100	111	1.0	90	1.0	2.1	146
(+)SMAJ100A	RZ	ZZ	111	123	1.0	100	1.0	1.9	162
(+)SMAJ110A	SE	VE	122	135	1.0	110	1.0	1.7	177
(+)SMAJ120A	VG	VG	133	147	1.0	120	1.0	1.6	193
(+)SMAJ130A	VK	VK	144	159	1.0	130	1.0	1.4	209
(+)SMAJ150A	VM	VM	167	185	1.0	150	1.0	1.2	243
(+)SMAJ160A	SP	VP	178	197	1.0	160	1.0	1.2	259
(+)SMAJ170A	SR	VR	189	209	1.0	170	1.0	1.09	275
(+)SMAJ188A	SS	VS	209	231	1.0	188	1.0	0.91	328

Notes

- (1) Pulse test: t_p ≤ 50 ms
- (2) Surge current waveform per fig. 3 and derate per fig. 2
- (3) For bi-directional types having V_{WM} of 10 V and less, the I_D limit is doubled
- (4) All terms and symbols are consistent with ANSI/IEEE C62.35
- (5) For the bi-directional SMAJ5.0CA, the maximum V_{BR} is 7.25 V
- (6) V_F = 3.5 V at I_F = 25 A (uni-directional only)
- (+) Underwriters Laboratory Recognition for the classification of protectors (QVGQ2) under the UL standard for safety 497B and file number E136766 for both uni-directional and bi-directional device

THERMAL CHARACTERISTICS ($T_A = 25\text{ }^\circ\text{C}$ unless otherwise noted)			
PARAMETER	SYMBOL	VALUE	UNIT
Typical thermal resistance, junction to ambient ⁽¹⁾	$R_{\theta JA}$	120	$^\circ\text{C/W}$
Typical thermal resistance, junction to lead	$R_{\theta JL}$	30	$^\circ\text{C/W}$

Note
⁽¹⁾ Mounted on minimum recommended pad layout

ORDERING INFORMATION (Example)				
PREFERRED P/N	UNIT WEIGHT (g)	PREFERRED PACKAGE CODE	BASE QUANTITY	DELIVERY MODE
SMAJ5.0A-E3/61	0.064	61	1800	7" diameter plastic tape and reel
SMAJ5.0A-M3/61				
SMAJ5.0A-E3/5A	0.064	5A	7500	13" diameter plastic tape and reel
SMAJ5.0A-M3/5A				
SMAJ5.0AHE3_A/H ⁽¹⁾	0.064	H	1800	7" diameter plastic tape and reel
SMAJ5.0AHM3_A/H ⁽¹⁾				
SMAJ5.0AHE3_A/I ⁽¹⁾	0.064	I	7500	13" diameter plastic tape and reel
SMAJ5.0AHM3_A/I ⁽¹⁾				

Note
⁽¹⁾ AEC-Q101 qualified

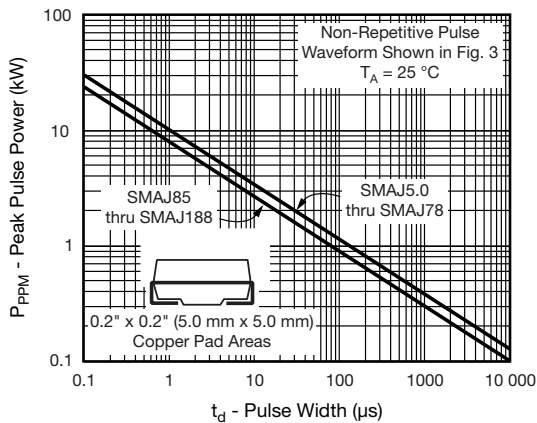
RATINGS AND CHARACTERISTICS CURVES ($T_A = 25\text{ }^\circ\text{C}$ unless otherwise noted)


Fig. 1 - Peak Pulse Power Rating Curve

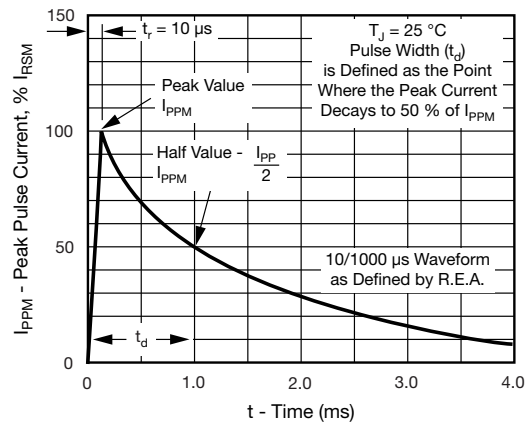


Fig. 3 - Pulse Waveform

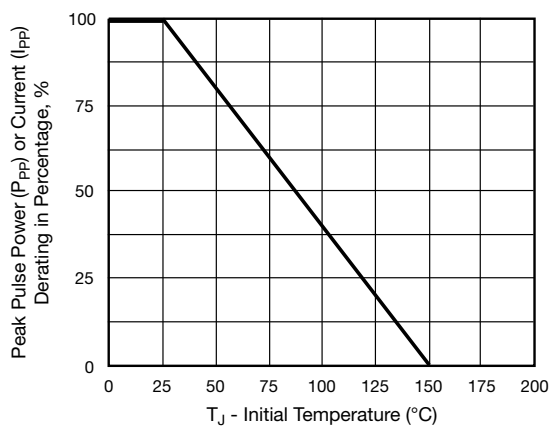


Fig. 2 - Pulse Power or Current vs. Initial Junction Temperature

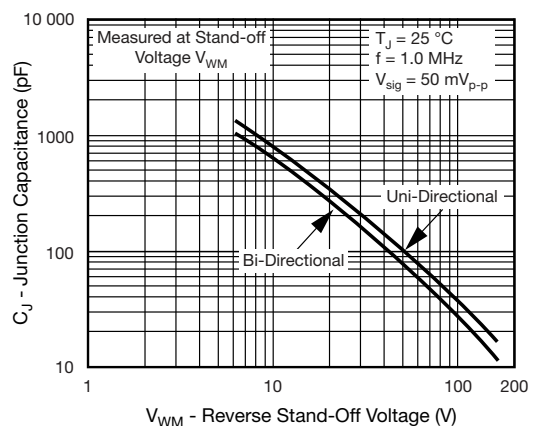


Fig. 4 - Typical Junction Capacitance

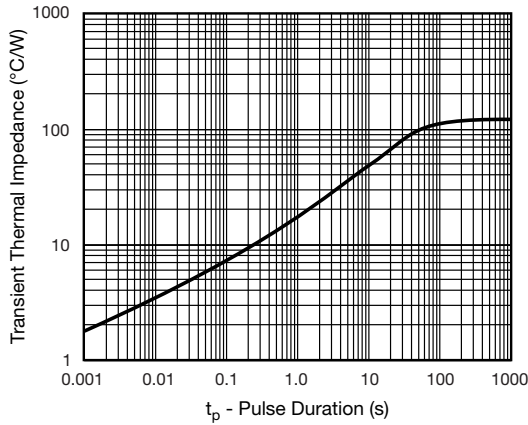


Fig. 5 - Typical Transient Thermal Impedance

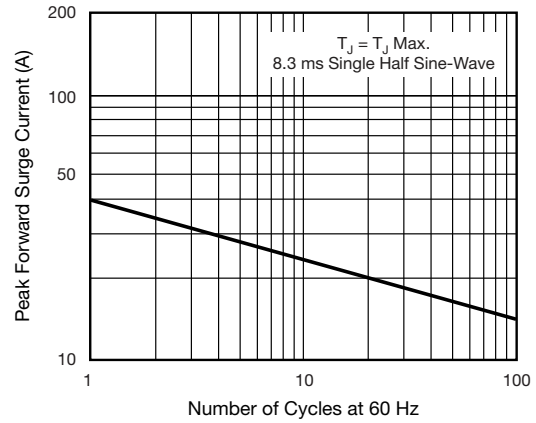
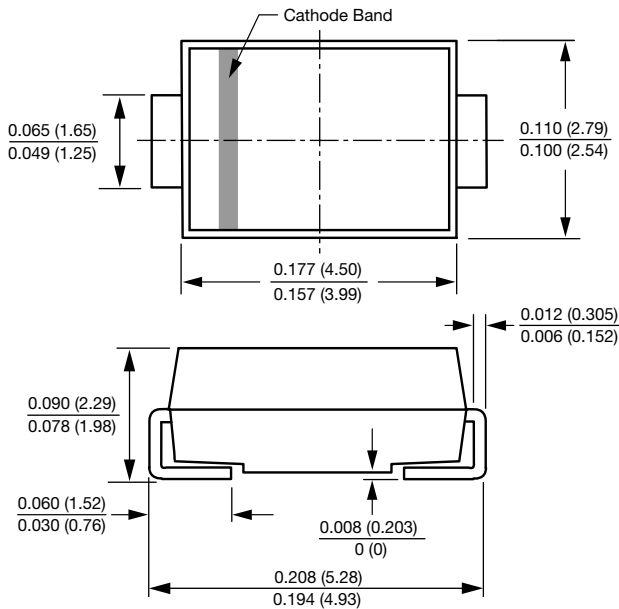


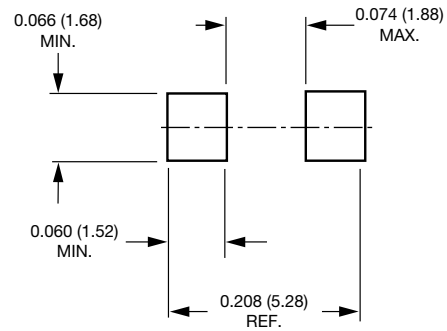
Fig. 6 - Maximum Non-Repetitive Forward Surge Current Uni-Directional Only

PACKAGE OUTLINE DIMENSIONS in inches (millimeters)

SMA (DO-214AC)



Mounting Pad Layout





Disclaimer

ALL PRODUCT, PRODUCT SPECIFICATIONS AND DATA ARE SUBJECT TO CHANGE WITHOUT NOTICE TO IMPROVE RELIABILITY, FUNCTION OR DESIGN OR OTHERWISE.

Vishay Intertechnology, Inc., its affiliates, agents, and employees, and all persons acting on its or their behalf (collectively, "Vishay"), disclaim any and all liability for any errors, inaccuracies or incompleteness contained in any datasheet or in any other disclosure relating to any product.

Vishay makes no warranty, representation or guarantee regarding the suitability of the products for any particular purpose or the continuing production of any product. To the maximum extent permitted by applicable law, Vishay disclaims (i) any and all liability arising out of the application or use of any product, (ii) any and all liability, including without limitation special, consequential or incidental damages, and (iii) any and all implied warranties, including warranties of fitness for particular purpose, non-infringement and merchantability.

Statements regarding the suitability of products for certain types of applications are based on Vishay's knowledge of typical requirements that are often placed on Vishay products in generic applications. Such statements are not binding statements about the suitability of products for a particular application. It is the customer's responsibility to validate that a particular product with the properties described in the product specification is suitable for use in a particular application. Parameters provided in datasheets and / or specifications may vary in different applications and performance may vary over time. All operating parameters, including typical parameters, must be validated for each customer application by the customer's technical experts. Product specifications do not expand or otherwise modify Vishay's terms and conditions of purchase, including but not limited to the warranty expressed therein.

Except as expressly indicated in writing, Vishay products are not designed for use in medical, life-saving, or life-sustaining applications or for any other application in which the failure of the Vishay product could result in personal injury or death. Customers using or selling Vishay products not expressly indicated for use in such applications do so at their own risk. Please contact authorized Vishay personnel to obtain written terms and conditions regarding products designed for such applications.

No license, express or implied, by estoppel or otherwise, to any intellectual property rights is granted by this document or by any conduct of Vishay. Product names and markings noted herein may be trademarks of their respective owners.

X-ON Electronics

Largest Supplier of Electrical and Electronic Components

Click to view similar products for TVS Diodes - Transient Voltage Suppressors category:

Click to view products by Vishay manufacturer:

Other Similar products are found below :

[60KS200C](#) [D12V0H1U2WS-7](#) [PSR05-LF-T7](#) [DESD5V0U1BB-7](#) [P6KE39CA-TP](#) [JAN1N6461](#) [SMAJ440A-TP](#) [SMLJ30CA-TP](#)
[ESD0P8RFL E6327](#) [ESD101-B1-02ELS E6327](#) [ESD103-B1-02EL E6327](#) [ESD105-B1-02EL E6327](#) [ESD112-B1-02EL E6327](#)
[ESD119B1W01005E6327XTSA1](#) [ESD5V0L1B02VH6327XTSA1](#) [T1042NLT](#) [3.0SMCJ36A-F](#) [JANTX1N6126A](#) [JANTX1N6465](#)
[DESD5V0U1BL-7B](#) [ESD200-B1-CSP0201 E6327](#) [ESD203-B1-02EL E6327](#) [SM12-7](#) [SMF8.0A-TP](#) [SMLJ45CA-TP](#) [CEN955 W/DATA](#)
[P6KE15CA-TP](#) [ESD101-B1-02EL E6327](#) [P6SMBJ20CA](#) [JANTX1N6163A](#) [SR2835ESKG](#) [SA90CA](#) [SA130A](#) [SMLJ40CA-TP](#) [ESD110-B1-](#)
[02ELS E6327](#) [ESD205-B1-02ELS E6327](#) [ESD208-B1-02ELS E6327](#) [PTVS12VZ1USKNYL](#) [3.0SMCJ24A-13](#) [3.0SMCJ30A-13](#) [30KPA36A-](#)
[LF](#) [30KPA48CALF](#) [3.0SMCJ28A-13](#) [3.0SMCJ5.0A-13](#) [TVS4201MR6T1G](#) [VS10P15C-LF](#) [VTVS9V4ASMF-M3-08](#) [RSA30LTE25](#)
[1.5KE100CA-B](#) [1.5KE400C-B](#)