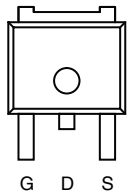

Automotive P-Channel 80 V (D-S) 175 °C MOSFET

| PRODUCT SUMMARY | |
|---|--------|
| V_{DS} (V) | - 80 |
| $R_{DS(on)}$ (Ω) at $V_{GS} = -10$ V | 0.028 |
| I_D (A) | - 48 |
| Configuration | Single |

TO-252

Top View

Drain Connected to Tab

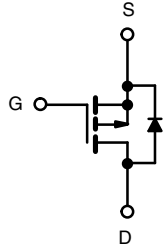

P-Channel MOSFET

FEATURES

- Halogen-free According to IEC 61249-2-21 Definition
- TrenchFET® Power MOSFET
- AEC-Q101 Qualified^d
- 100 % R_g and UIS Tested
- Compliant to RoHS Directive 2002/95/EC

AUTOMOTIVE GRADE

RoHS
 COMPLIANT
 HALOGEN
FREE

| ORDERING INFORMATION | |
|---------------------------------|-----------------|
| Package | TO-252 |
| Lead (Pb)-free and Halogen-free | SQD50P08-28-GE3 |

| ABSOLUTE MAXIMUM RATINGS ($T_C = 25$ °C, unless otherwise noted) | | | |
|---|----------------|----------------|------|
| PARAMETER | SYMBOL | LIMIT | UNIT |
| Drain-Source Voltage | V_{DS} | - 80 | V |
| Gate-Source Voltage | V_{GS} | ± 20 | |
| Continuous Drain Current | I_D | $T_C = 25$ °C | - 48 |
| | | $T_C = 125$ °C | - 28 |
| Continuous Source Current (Diode Conduction) ^a | I_S | - 50 | A |
| Pulsed Drain Current ^b | I_{DM} | - 190 | |
| Single Pulse Avalanche Current | I_{AS} | - 45 | |
| Single Pulse Avalanche Energy | E_{AS} | 100 | |
| Maximum Power Dissipation ^b | P_D | $T_C = 25$ °C | 136 |
| | | $T_C = 125$ °C | 45 |
| Operating Junction and Storage Temperature Range | T_J, T_{stg} | - 55 to + 175 | °C |

| THERMAL RESISTANCE RATINGS | | | |
|----------------------------|------------|-------|------|
| PARAMETER | SYMBOL | LIMIT | UNIT |
| Junction-to-Ambient | R_{thJA} | 50 | °C/W |
| Junction-to-Case (Drain) | R_{thJC} | 1.1 | |

Notes

- Package limited.
- Pulse test; pulse width ≤ 300 μ s, duty cycle ≤ 2 %.
- When mounted on 1" square PCB (FR-4 material).
- Parametric verification ongoing.

| SPECIFICATIONS ($T_C = 25\text{ }^\circ\text{C}$, unless otherwise noted) | | | | | | | |
|--|--------------|---|--|------|-----------|-------|---------------|
| PARAMETER | SYMBOL | TEST CONDITIONS | MIN. | TYP. | MAX. | UNIT | |
| Static | | | | | | | |
| Drain-Source Breakdown Voltage | V_{DS} | $V_{GS} = 0, I_D = -250\text{ }\mu\text{A}$ | -80 | - | - | V | |
| Gate-Source Threshold Voltage | $V_{GS(th)}$ | $V_{DS} = V_{GS}, I_D = -250\text{ }\mu\text{A}$ | -2.5 | -3.0 | -3.5 | | |
| Gate-Source Leakage | I_{GSS} | $V_{DS} = 0\text{ V}, V_{GS} = \pm 20\text{ V}$ | - | - | ± 100 | nA | |
| Zero Gate Voltage Drain Current | I_{DSS} | $V_{GS} = 0\text{ V}$ | $V_{DS} = -80\text{ V}$ | - | - | -1 | μA |
| | | $V_{GS} = 0\text{ V}$ | $V_{DS} = -80\text{ V}, T_J = 125\text{ }^\circ\text{C}$ | - | - | -50 | |
| | | $V_{GS} = 0\text{ V}$ | $V_{DS} = -80\text{ V}, T_J = 175\text{ }^\circ\text{C}$ | - | - | -250 | |
| On-State Drain Current ^a | $I_{D(on)}$ | $V_{GS} = -10\text{ V}$ | $V_{DS} \leq -5\text{ V}$ | -50 | - | A | |
| Drain-Source On-State Resistance ^a | $R_{DS(on)}$ | $V_{GS} = -10\text{ V}$ | $I_D = -12.5\text{ A}$ | - | 0.023 | 0.028 | Ω |
| | | $V_{GS} = -10\text{ V}$ | $I_D = -12.5\text{ A}, T_J = 125\text{ }^\circ\text{C}$ | - | - | 0.049 | |
| | | $V_{GS} = -10\text{ V}$ | $I_D = -12.5\text{ A}, T_J = 175\text{ }^\circ\text{C}$ | - | - | 0.061 | |
| Forward Transconductance ^b | g_{fs} | $V_{DS} = -15\text{ V}, I_D = -12.5\text{ A}$ | - | 32 | - | S | |
| Dynamic^b | | | | | | | |
| Input Capacitance | C_{iss} | $V_{GS} = 0\text{ V}$ | $V_{DS} = -25\text{ V}, f = 1\text{ MHz}$ | - | 4826 | 6035 | pF |
| Output Capacitance | C_{oss} | | | - | 343 | 430 | |
| Reverse Transfer Capacitance | C_{rss} | | | - | 224 | 280 | |
| Total Gate Charge ^c | Q_g | $V_{GS} = -10\text{ V}$ | $V_{DS} = -40\text{ V}, I_D = -12.5\text{ A}$ | - | 95 | 145 | nC |
| Gate-Source Charge ^c | Q_{gs} | | | - | 19 | - | |
| Gate-Drain Charge ^c | Q_{gd} | | | - | 26 | - | |
| Gate Resistance | R_g | f = 1 MHz | | 1.73 | 3.47 | 5.21 | Ω |
| Turn-On Delay Time ^c | $t_{d(on)}$ | $V_{DD} = -40\text{ V}, R_L = 3.8\text{ }\Omega$ $I_D \cong -10.5\text{ A}, V_{GEN} = -10\text{ V}, R_g = 1\text{ }\Omega$ | | - | 15 | 23 | ns |
| Rise Time ^c | t_r | | | - | 11 | 17 | |
| Turn-Off Delay Time ^c | $t_{d(off)}$ | | | - | 65 | 98 | |
| Fall Time ^c | t_f | | | - | 16 | 24 | |
| Source-Drain Diode Ratings and Characteristics^b | | | | | | | |
| Pulsed Current ^a | I_{SM} | | | - | - | -190 | A |
| Forward Voltage | V_{SD} | $I_F = -10\text{ A}, V_{GS} = 0$ | | - | -0.82 | -1.5 | V |

Notes

- Pulse test; pulse width $\leq 300\text{ }\mu\text{s}$, duty cycle $\leq 2\%$.
- Guaranteed by design, not subject to production testing.
- Independent of operating temperature.

Stresses beyond those listed under "Absolute Maximum Ratings" may cause permanent damage to the device. These are stress ratings only, and functional operation of the device at these or any other conditions beyond those indicated in the operational sections of the specifications is not implied. Exposure to absolute maximum rating conditions for extended periods may affect device reliability.

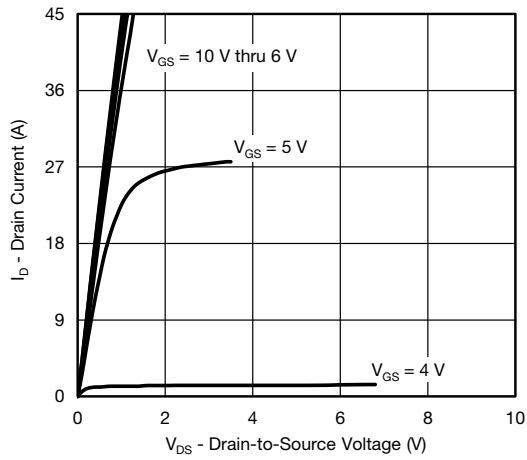
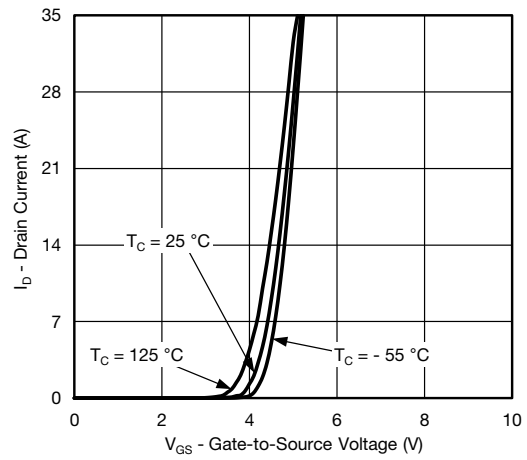
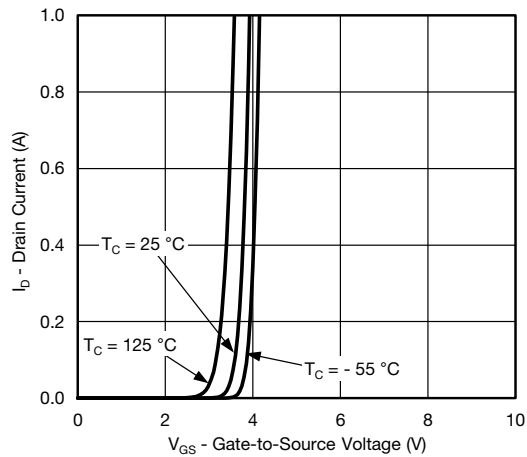
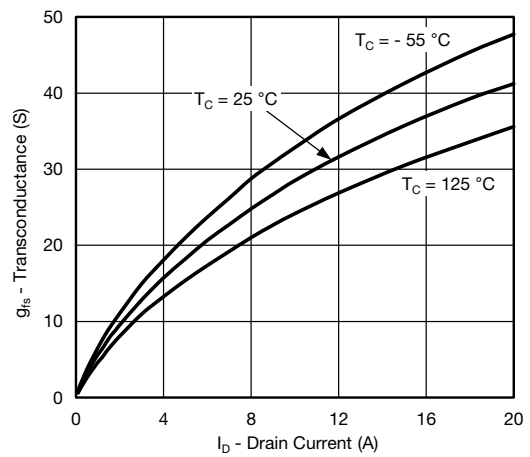
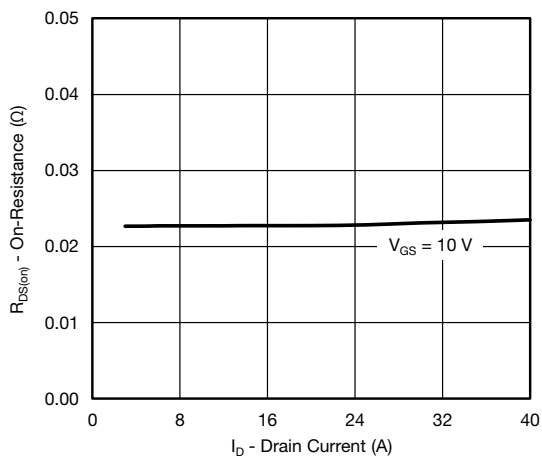
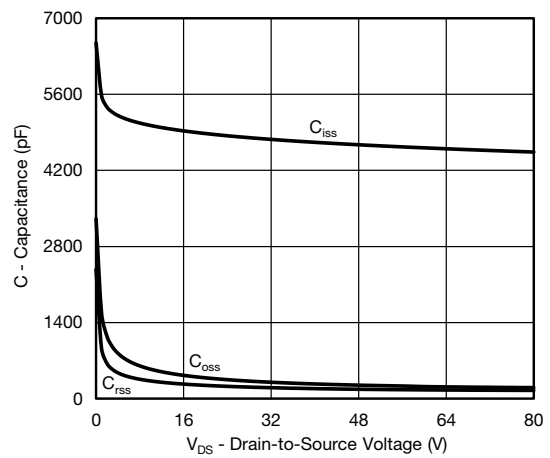
TYPICAL CHARACTERISTICS ($T_A = 25\text{ }^\circ\text{C}$, unless otherwise noted)

Output Characteristics

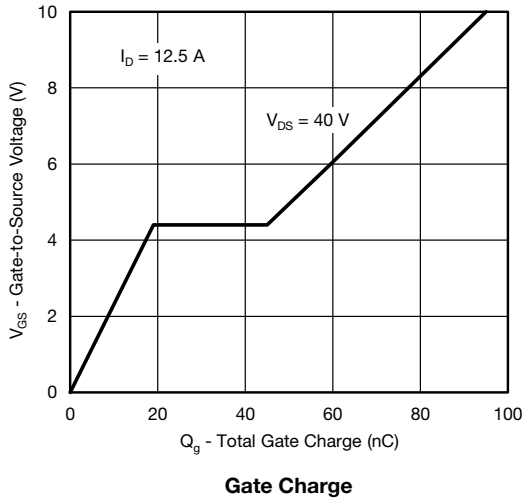
Transfer Characteristics

Transfer Characteristics

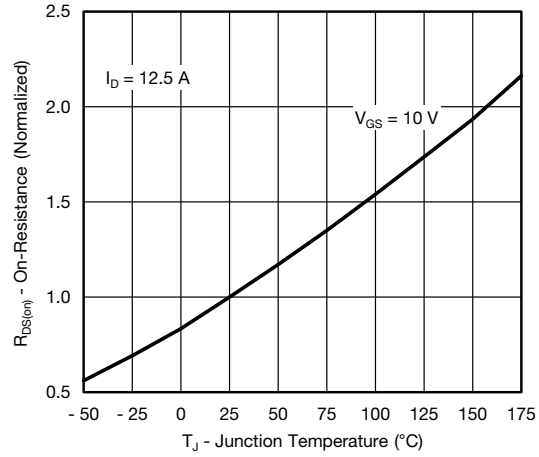
Transconductance

On-Resistance vs. Drain Current

Capacitance

TYPICAL CHARACTERISTICS ($T_A = 25\text{ }^\circ\text{C}$, unless otherwise noted)



Gate Charge



On-Resistance vs. Junction Temperature

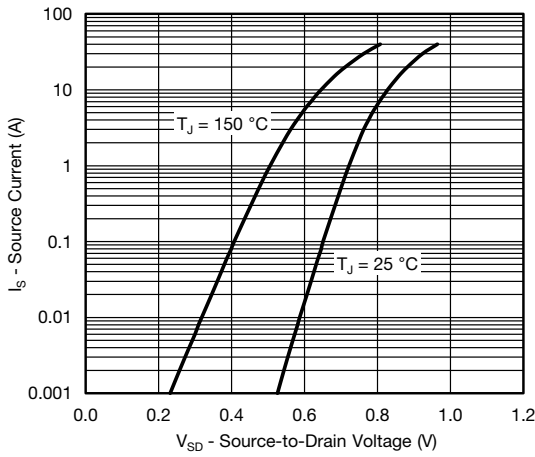

Source Drain Diode Forward Voltage

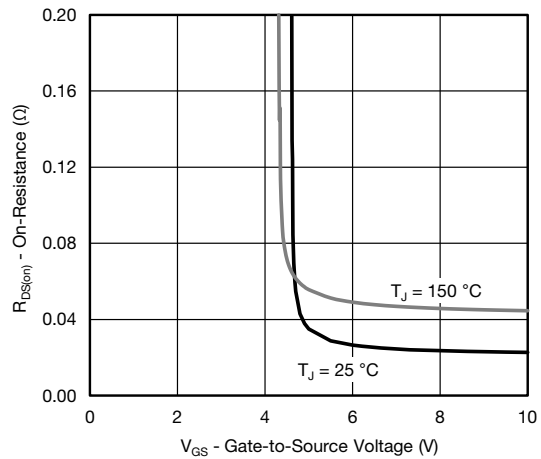

On-Resistance vs. Gate-to-Source Voltage

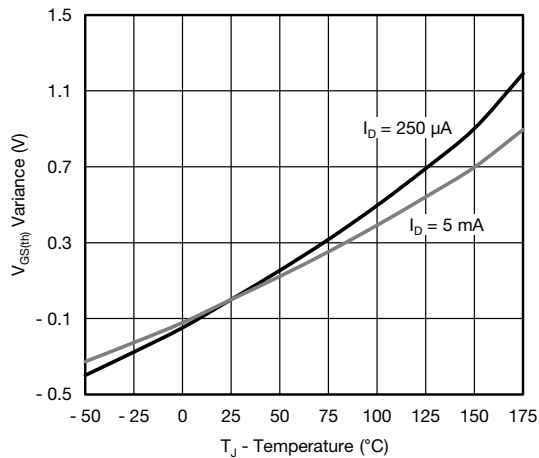

Threshold Voltage

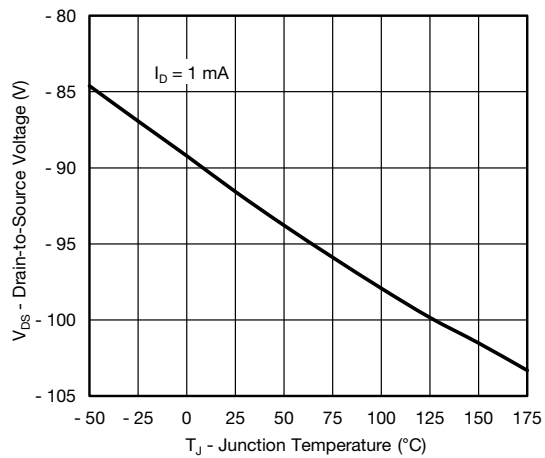

Drain Source Breakdown vs. Junction Temperature

THERMAL RATINGS ($T_A = 25\text{ }^\circ\text{C}$, unless otherwise noted)

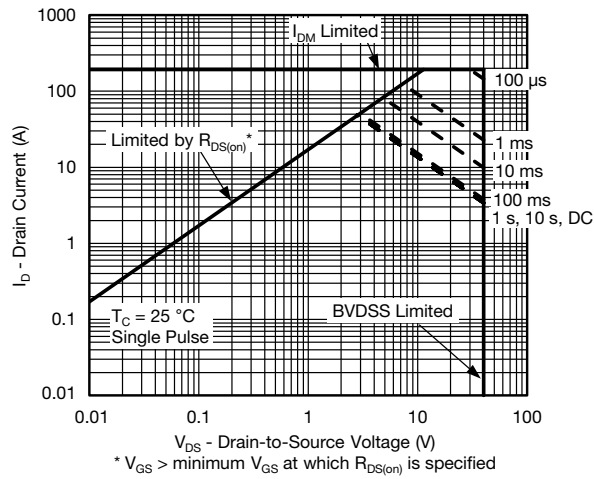

Safe Operating Area

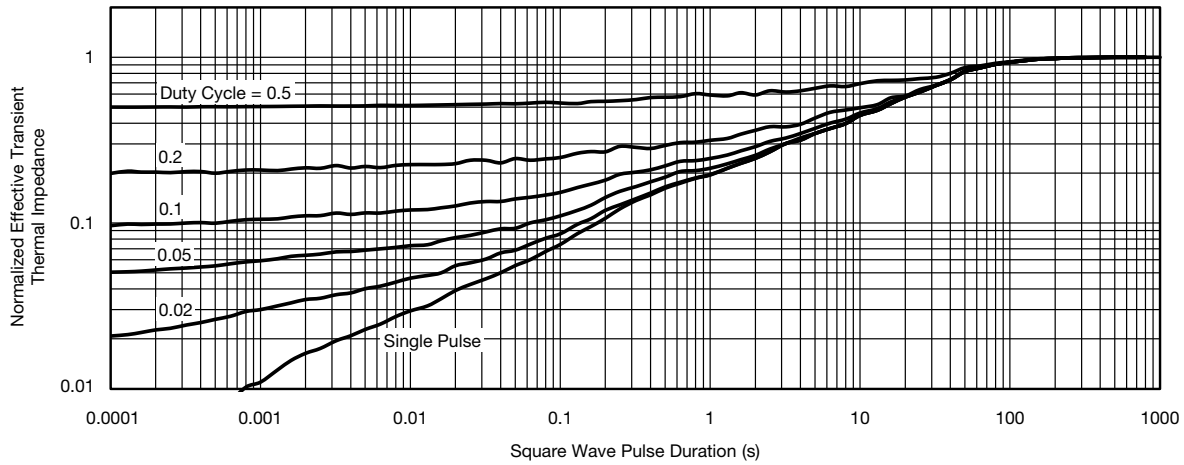

Normalized Thermal Transient Impedance, Junction-to-Ambient

THERMAL RATINGS ($T_A = 25\text{ }^\circ\text{C}$, unless otherwise noted)

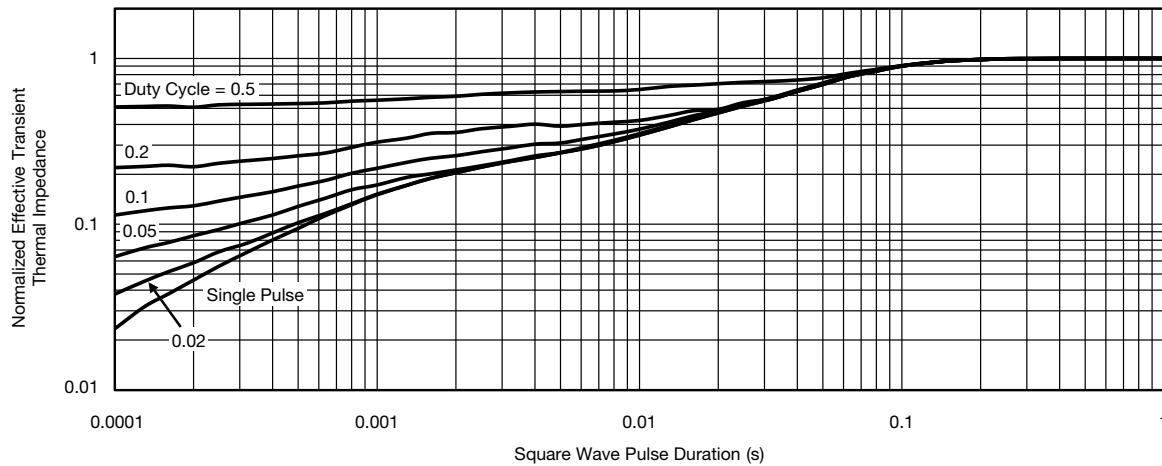

Normalized Thermal Transient Impedance, Junction-to-Case

Note

- The characteristics shown in the two graphs
 - Normalized Transient Thermal Impedance Junction-to-Ambient ($25\text{ }^\circ\text{C}$)
 - Normalized Transient Thermal Impedance Junction-to-Case ($25\text{ }^\circ\text{C}$)
- are given for general guidelines only to enable the user to get a “ball park” indication of part capabilities. The data are extracted from single pulse transient thermal impedance characteristics which are developed from empirical measurements. The latter is valid for the part mounted on printed circuit board - FR4, size 1" x 1" x 0.062", double sided with 2 oz. copper, 100 % on both sides. The part capabilities can widely vary depending on actual application parameters and operating conditions.

Vishay Siliconix maintains worldwide manufacturing capability. Products may be manufactured at one of several qualified locations. Reliability data for Silicon Technology and Package Reliability represent a composite of all qualified locations. For related documents such as package/tape drawings, part marking, and reliability data, see www.vishay.com/ppg?63215.



DPAK / TO-252 and Reverse DPAK

Ordering codes for the SQ rugged series power MOSFETs in the DPAK / TO-252 and Reverse DPAK packages:

Table with 3 columns: DATASHEET PART NUMBER, OLD ORDERING CODE a, NEW ORDERING CODE. Lists various MOSFET part numbers and their corresponding ordering codes.

Note

a. Old ordering code is obsolete and no longer valid for new orders



TO-252AA Case Outline



| DIM. | MILLIMETERS | | INCHES | |
|---------------------------------|-------------|-------|-----------|-------|
| | MIN. | MAX. | MIN. | MAX. |
| A | 2.18 | 2.38 | 0.086 | 0.094 |
| A1 | - | 0.127 | - | 0.005 |
| b | 0.64 | 0.88 | 0.025 | 0.035 |
| b2 | 0.76 | 1.14 | 0.030 | 0.045 |
| b3 | 4.95 | 5.46 | 0.195 | 0.215 |
| C | 0.46 | 0.61 | 0.018 | 0.024 |
| C2 | 0.46 | 0.89 | 0.018 | 0.035 |
| D | 5.97 | 6.22 | 0.235 | 0.245 |
| D1 | 4.10 | - | 0.161 | - |
| E | 6.35 | 6.73 | 0.250 | 0.265 |
| E1 | 4.32 | - | 0.170 | - |
| H | 9.40 | 10.41 | 0.370 | 0.410 |
| e | 2.28 BSC | | 0.090 BSC | |
| e1 | 4.56 BSC | | 0.180 BSC | |
| L | 1.40 | 1.78 | 0.055 | 0.070 |
| L3 | 0.89 | 1.27 | 0.035 | 0.050 |
| L4 | - | 1.02 | - | 0.040 |
| L5 | 1.01 | 1.52 | 0.040 | 0.060 |
| ECN: T13-0592-Rev. A, 02-Sep-13 | | | | |
| DWG: 6019 | | | | |

Note

- Dimension L3 is for reference only.

RECOMMENDED MINIMUM PADS FOR DPAK (TO-252)



Recommended Minimum Pads
Dimensions in Inches/(mm)

[Return to Index](#)



Disclaimer

ALL PRODUCT, PRODUCT SPECIFICATIONS AND DATA ARE SUBJECT TO CHANGE WITHOUT NOTICE TO IMPROVE RELIABILITY, FUNCTION OR DESIGN OR OTHERWISE.

Vishay Intertechnology, Inc., its affiliates, agents, and employees, and all persons acting on its or their behalf (collectively, "Vishay"), disclaim any and all liability for any errors, inaccuracies or incompleteness contained in any datasheet or in any other disclosure relating to any product.

Vishay makes no warranty, representation or guarantee regarding the suitability of the products for any particular purpose or the continuing production of any product. To the maximum extent permitted by applicable law, Vishay disclaims (i) any and all liability arising out of the application or use of any product, (ii) any and all liability, including without limitation special, consequential or incidental damages, and (iii) any and all implied warranties, including warranties of fitness for particular purpose, non-infringement and merchantability.

Statements regarding the suitability of products for certain types of applications are based on Vishay's knowledge of typical requirements that are often placed on Vishay products in generic applications. Such statements are not binding statements about the suitability of products for a particular application. It is the customer's responsibility to validate that a particular product with the properties described in the product specification is suitable for use in a particular application. Parameters provided in datasheets and/or specifications may vary in different applications and performance may vary over time. All operating parameters, including typical parameters, must be validated for each customer application by the customer's technical experts. Product specifications do not expand or otherwise modify Vishay's terms and conditions of purchase, including but not limited to the warranty expressed therein.

Except as expressly indicated in writing, Vishay products are not designed for use in medical, life-saving, or life-sustaining applications or for any other application in which the failure of the Vishay product could result in personal injury or death. Customers using or selling Vishay products not expressly indicated for use in such applications do so at their own risk. Please contact authorized Vishay personnel to obtain written terms and conditions regarding products designed for such applications.

No license, express or implied, by estoppel or otherwise, to any intellectual property rights is granted by this document or by any conduct of Vishay. Product names and markings noted herein may be trademarks of their respective owners.

Material Category Policy

Vishay Intertechnology, Inc. hereby certifies that all its products that are identified as RoHS-Compliant fulfill the definitions and restrictions defined under Directive 2011/65/EU of The European Parliament and of the Council of June 8, 2011 on the restriction of the use of certain hazardous substances in electrical and electronic equipment (EEE) - recast, unless otherwise specified as non-compliant.

Please note that some Vishay documentation may still make reference to RoHS Directive 2002/95/EC. We confirm that all the products identified as being compliant to Directive 2002/95/EC conform to Directive 2011/65/EU.

Vishay Intertechnology, Inc. hereby certifies that all its products that are identified as Halogen-Free follow Halogen-Free requirements as per JEDEC JS709A standards. Please note that some Vishay documentation may still make reference to the IEC 61249-2-21 definition. We confirm that all the products identified as being compliant to IEC 61249-2-21 conform to JEDEC JS709A standards.

X-ON Electronics

Largest Supplier of Electrical and Electronic Components

Click to view similar products for [MOSFET](#) category:

Click to view products by [Vishay](#) manufacturer:

Other Similar products are found below :

[614233C](#) [648584F](#) [IRFD120](#) [JANTX2N5237](#) [2N7000](#) [FCA20N60_F109](#) [FDZ595PZ](#) [2SK2545\(Q,T\)](#) [405094E](#) [423220D](#)
[TPCC8103,L1Q\(CM](#) [MIC4420CM-TR](#) [VN1206L](#) [614234A](#) [715780A](#) [NTNS3166NZT5G](#) [SSM6J414TU,LF\(T](#) [751625C](#)
[IPS70R2K0CEAKMA1](#) [BUK954R8-60E](#) [DMN3404LQ-7](#) [NTE6400](#) [SQJ402EP-T1-GE3](#) [2SK2614\(TE16L1,Q\)](#) [2N7002KW-FAI](#)
[DMN1017UCP3-7](#) [EFC2J004NUZTDG](#) [ECH8691-TL-W](#) [FCAB21350L1](#) [P85W28HP2F-7071](#) [DMN1053UCP4-7](#) [NTE221](#) [NTE2384](#)
[NTE2903](#) [NTE2941](#) [NTE2945](#) [NTE2946](#) [NTE2960](#) [NTE2967](#) [NTE2969](#) [NTE2976](#) [NTE455](#) [NTE6400A](#) [NTE2910](#) [NTE2916](#) [NTE2956](#)
[NTE2911](#) [US6M2GTR](#) [TK10A80W,S4X\(S](#) [SSM6P69NU,LF](#)