

Automotive P-Channel 30 V (D-S) 175 °C MOSFET

 AUTOMOTIVE
GRADE

RoHS
COMPLIANT
HALOGEN
FREE

PRODUCT SUMMARY	
V_{DS} (V)	-30
$R_{DS(on)}$ (Ω) at $V_{GS} = -10$ V	0.0085
$R_{DS(on)}$ (Ω) at $V_{GS} = -4.5$ V	0.0200
I_D (A)	-30 ^a
Configuration	Single
Package	PowerPAK SO-8L

FEATURES

- TrenchFET® power MOSFET
- ESD protection: 3000 V
- AEC-Q101 qualified
- 100 % R_g and UIS tested
- Material categorization:
for definitions of compliance please see
www.vishay.com/doc?99912

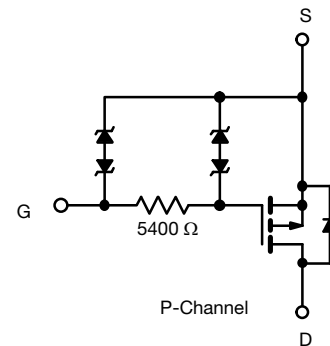
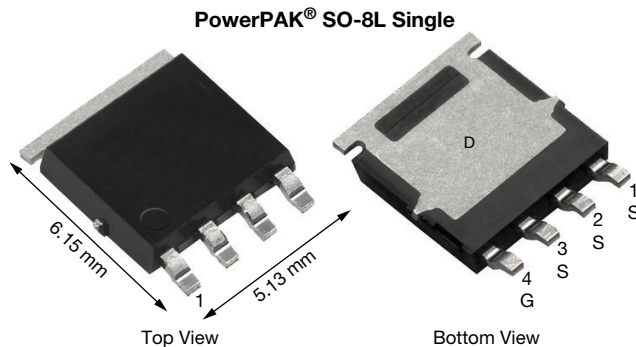

ABSOLUTE MAXIMUM RATINGS ($T_C = 25$ °C, unless otherwise noted)			
PARAMETER	SYMBOL	LIMIT	UNIT
Drain-Source Voltage	V_{DS}	-30	V
Gate-Source Voltage	V_{GS}	± 20	
Continuous Drain Current ^a	I_D	$T_C = 25$ °C	-30
		$T_C = 125$ °C	-30
Continuous Source Current (Diode conduction) ^a	I_S	-30	A
Pulsed Drain Current ^b	I_{DM}	-84	mJ
Single Pulse Avalanche Current	I_{AS}	-6.5	
Single Pulse Avalanche Energy	E_{AS}	211	W
Maximum Power Dissipation ^b	P_D	$T_C = 25$ °C	
		$T_C = 125$ °C	22
Operating Junction and Storage Temperature Range	T_J, T_{stg}	-55 to +175	°C
Soldering Recommendations (Peak temperature) ^{d, e}		260	

THERMAL RESISTANCE RATINGS			
PARAMETER	SYMBOL	LIMIT	UNIT
Junction-to-Ambient	R_{thJA}	68	°C/W
Junction-to-Case (Drain)	R_{thJC}	2.2	

Notes

- Package limited.
- Pulse test; pulse width ≤ 300 μ s, duty cycle ≤ 2 %.
- When mounted on 1" square PCB (FR4 material).
- See solder profile (www.vishay.com/doc?73257). The end of the lead terminal of PowerPAK SO-8L is exposed copper (not plated) as a result of the singulation process in manufacturing. A solder fillet at the exposed copper tip cannot be guaranteed and is not required to ensure adequate bottom side solder interconnection.
- Rework conditions: manual soldering with a soldering iron is not recommended for leadless components.



SPECIFICATIONS ($T_C = 25\text{ }^\circ\text{C}$, unless otherwise noted)							
PARAMETER	SYMBOL	TEST CONDITIONS		MIN.	TYP.	MAX.	UNIT
Static							
Drain-Source Breakdown Voltage	V_{DS}	$V_{GS} = 0\text{ V}$, $I_D = -250\text{ }\mu\text{A}$		-30	-	-	V
Gate-Source Threshold Voltage	$V_{GS(th)}$	$V_{DS} = V_{GS}$, $I_D = -250\text{ }\mu\text{A}$		-1.5	-2.0	-2.5	
Gate-Source Leakage	I_{GSS}	$V_{DS} = 0\text{ V}$, $V_{GS} = \pm 12\text{ V}$		-	-	± 2	μA
		$V_{DS} = 0\text{ V}$, $V_{GS} = \pm 20\text{ V}$		-	-	± 1	mA
Zero Gate Voltage Drain Current	I_{DSS}	$V_{GS} = 0\text{ V}$	$V_{DS} = -30\text{ V}$	-	-	-1	μA
		$V_{GS} = 0\text{ V}$	$V_{DS} = -30\text{ V}$, $T_J = 125\text{ }^\circ\text{C}$	-	-	-50	
		$V_{GS} = 0\text{ V}$	$V_{DS} = -30\text{ V}$, $T_J = 175\text{ }^\circ\text{C}$	-	-	-250	
On-State Drain Current ^a	$I_{D(on)}$	$V_{GS} = -10\text{ V}$	$V_{DS} \leq -5\text{ V}$	-30	-	-	A
Drain-Source On-State Resistance ^a	$R_{DS(on)}$	$V_{GS} = -10\text{ V}$	$I_D = -10\text{ A}$	-	0.0070	0.0085	Ω
		$V_{GS} = -10\text{ V}$	$I_D = -10\text{ A}$, $T_J = 125\text{ }^\circ\text{C}$	-	-	0.0130	
		$V_{GS} = -10\text{ V}$	$I_D = -10\text{ A}$, $T_J = 175\text{ }^\circ\text{C}$	-	-	0.0150	
		$V_{GS} = -4.5\text{ V}$	$I_D = -7\text{ A}$	-	0.0120	0.0200	
Forward Transconductance ^b	g_{fs}	$V_{DS} = -10\text{ V}$, $I_D = -10\text{ A}$		-	32	-	S
Dynamic ^b							
Output Capacitance	C_{oss}	$V_{GS} = 0\text{ V}$	$V_{DS} = -15\text{ V}$, $f = 1\text{ MHz}$	-	712	890	μF
Total Gate Charge ^c	Q_g	$V_{GS} = -10\text{ V}$	$V_{DS} = -15\text{ V}$, $I_D = -10\text{ A}$	-	75	164	nC
Gate-Source Charge ^c	Q_{gs}			-	9.5	-	
Gate-Drain Charge ^c	Q_{gd}			-	19	-	
Gate Resistance	R_g	$f = 1\text{ MHz}$		2	4.3	7.5	$\text{k}\Omega$
Turn-On Delay Time ^c	$t_{d(on)}$	$V_{DD} = -15\text{ V}$, $R_L = 1.5\text{ }\Omega$ $I_D \equiv -10\text{ A}$, $V_{GEN} = -10\text{ V}$, $R_g = 1\text{ }\Omega$		-	38	57	ns
Rise Time ^c	t_r			-	82	123	
Turn-Off Delay Time ^c	$t_{d(off)}$			-	134	201	
Fall Time ^c	t_f			-	178	214	
Source-Drain Diode Ratings and Characteristics ^b							
Pulsed Current ^a	I_{SM}			-	-	-84	A
Forward Voltage	V_{SD}	$I_F = -3\text{ A}$, $V_{GS} = 0\text{ V}$		-	-0.75	-1.2	V

Notes

- Pulse test; pulse width $\leq 300\text{ }\mu\text{s}$, duty cycle $\leq 2\%$.
- Guaranteed by design, not subject to production testing.
- Independent of operating temperature.

Stresses beyond those listed under "Absolute Maximum Ratings" may cause permanent damage to the device. These are stress ratings only, and functional operation of the device at these or any other conditions beyond those indicated in the operational sections of the specifications is not implied. Exposure to absolute maximum rating conditions for extended periods may affect device reliability.



TYPICAL CHARACTERISTICS (25 °C, unless otherwise noted)

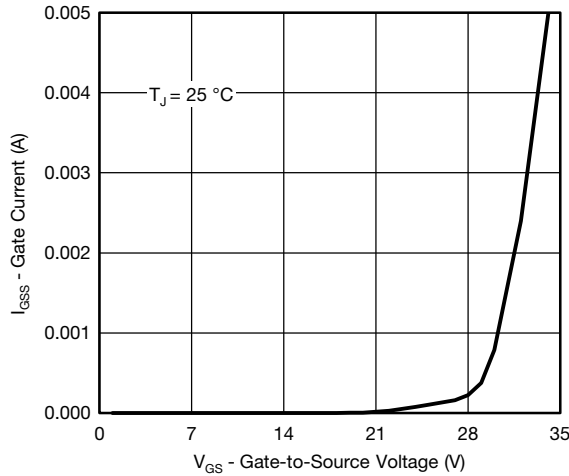

Gate Current vs. Gate-Source Voltage

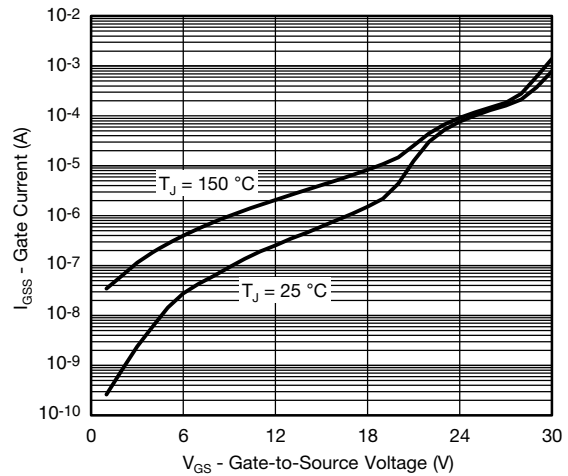

Gate Current vs. Gate-Source Voltage

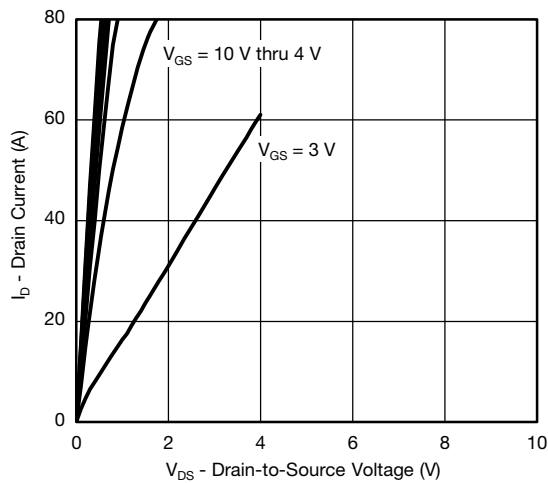

Output Characteristics

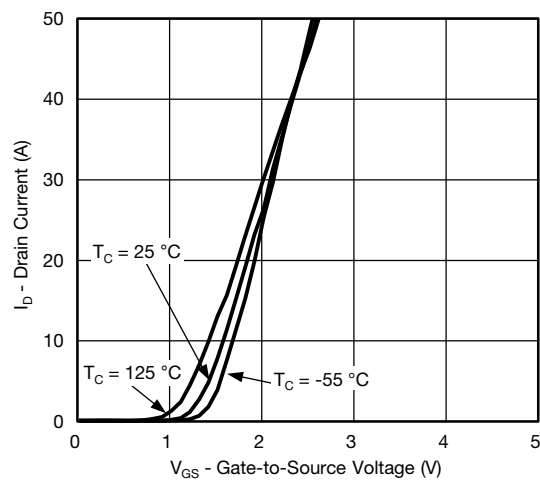

Transfer Characteristics

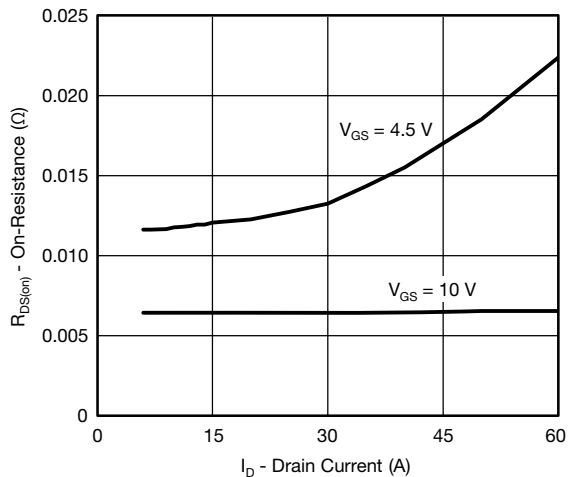

On-Resistance vs. Drain Current

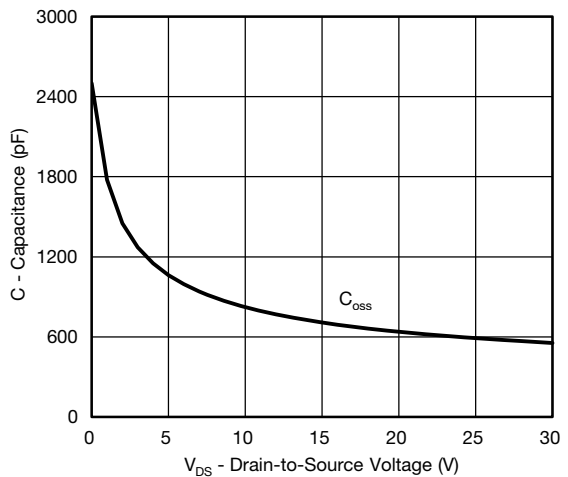

Capacitance



TYPICAL CHARACTERISTICS (25 °C, unless otherwise noted)

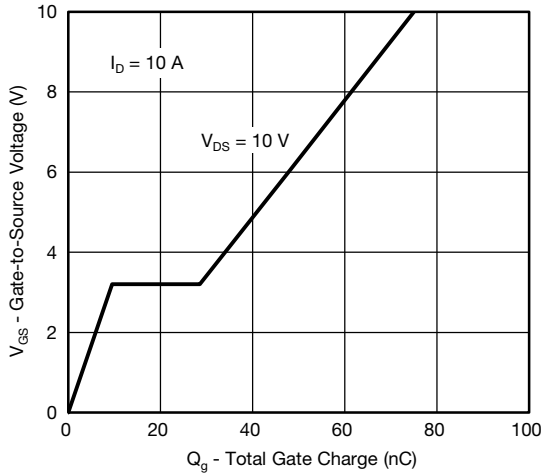

Gate Charge

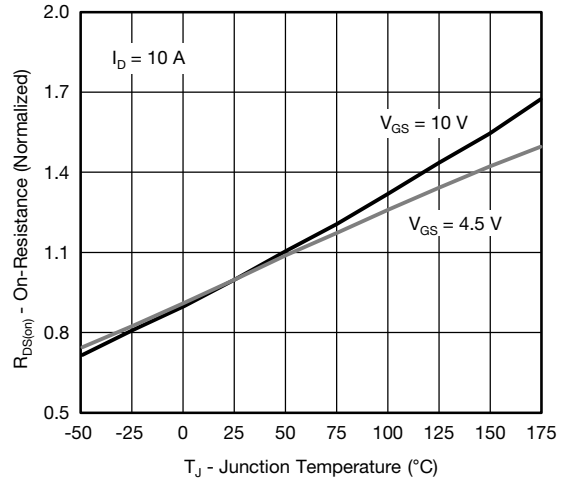

On-Resistance vs. Junction Temperature

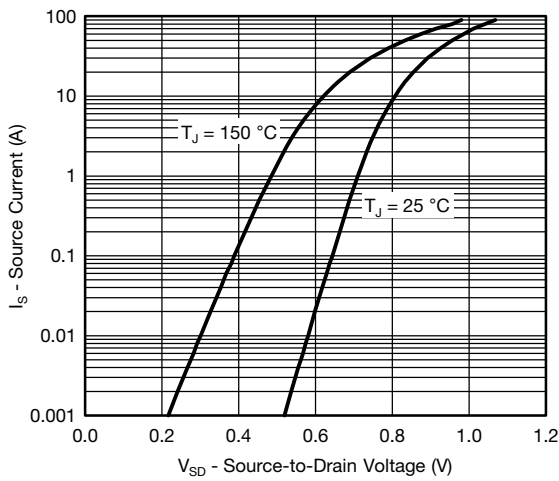

Source Drain Diode Forward Voltage

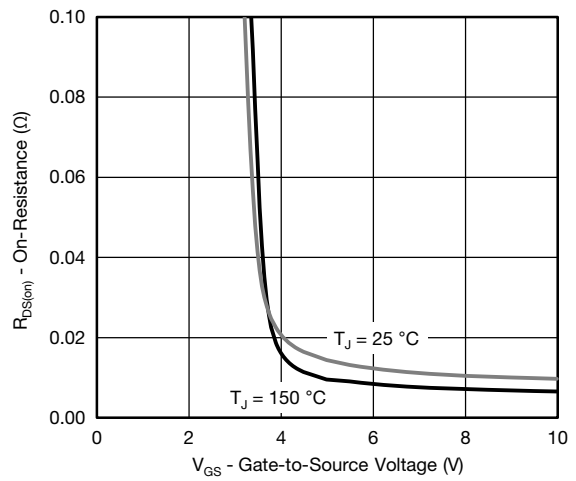

On-Resistance vs. Gate-to-Source Voltage

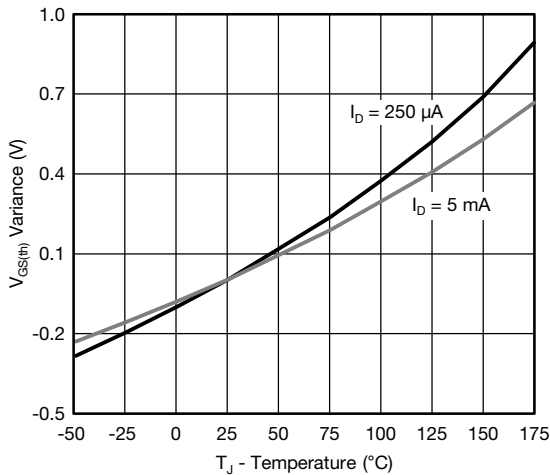

Threshold Voltage

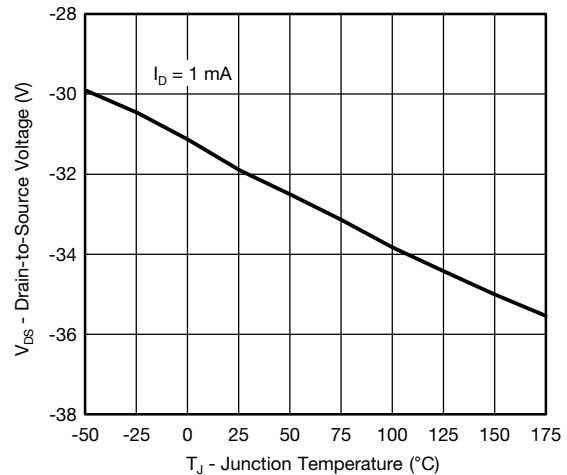

Drain Source Breakdown vs. Junction Temperature

THERMAL RATINGS ($T_A = 25\text{ }^\circ\text{C}$, unless otherwise noted)

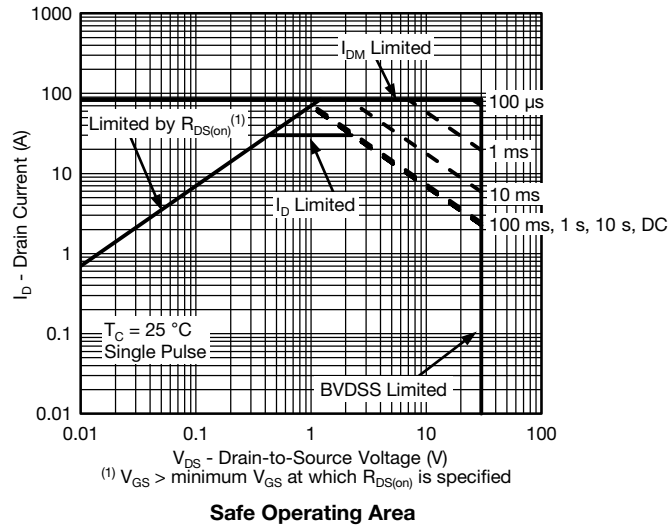

Safe Operating Area

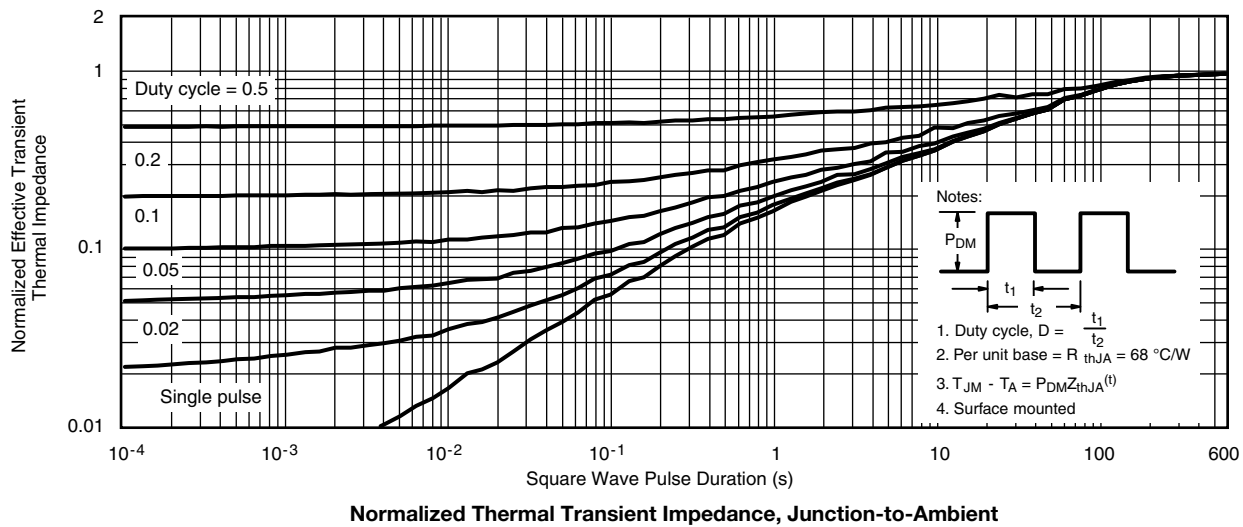

Normalized Thermal Transient Impedance, Junction-to-Ambient



THERMAL RATINGS ($T_A = 25\text{ }^\circ\text{C}$, unless otherwise noted)

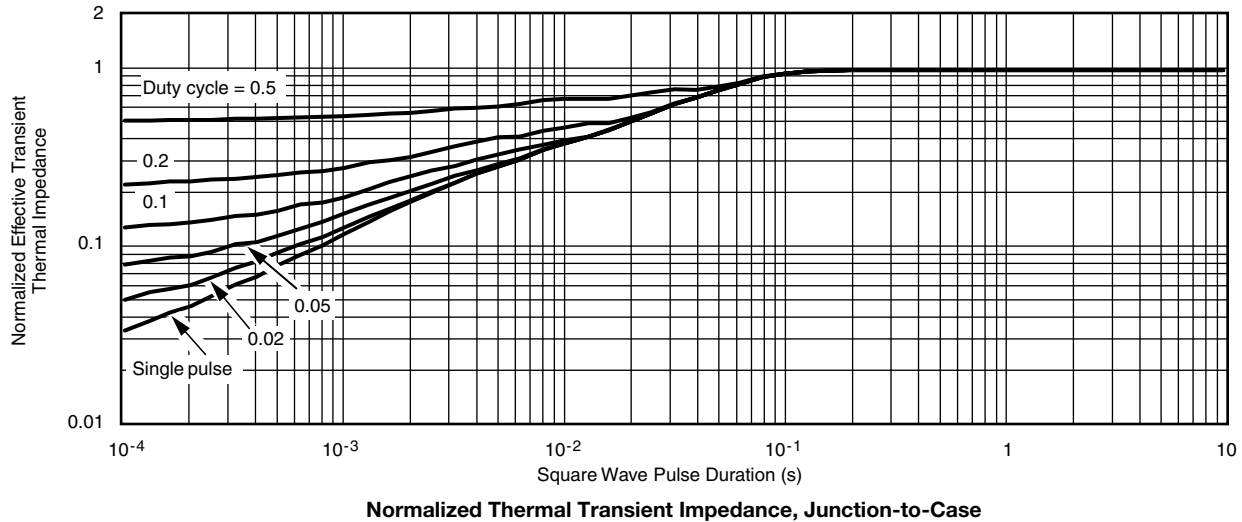

Note

- The characteristics shown in the two graphs
 - Normalized Transient Thermal Impedance Junction-to-Ambient ($25\text{ }^\circ\text{C}$)
 - Normalized Transient Thermal Impedance Junction-to-Case ($25\text{ }^\circ\text{C}$)
 are given for general guidelines only to enable the user to get a “ball park” indication of part capabilities. The data are extracted from single pulse transient thermal impedance characteristics which are developed from empirical measurements. The latter is valid for the part mounted on printed circuit board - FR4, size 1" x 1" x 0.062", double sided with 2 oz. copper, 100 % on both sides. The part capabilities can widely vary depending on actual application parameters and operating conditions.

Vishay Siliconix maintains worldwide manufacturing capability. Products may be manufactured at one of several qualified locations. Reliability data for Silicon Technology and Package Reliability represent a composite of all qualified locations. For related documents such as package/tape drawings, part marking, and reliability data, see www.vishay.com/ppg?267407.



Disclaimer

ALL PRODUCT, PRODUCT SPECIFICATIONS AND DATA ARE SUBJECT TO CHANGE WITHOUT NOTICE TO IMPROVE RELIABILITY, FUNCTION OR DESIGN OR OTHERWISE.

Vishay Intertechnology, Inc., its affiliates, agents, and employees, and all persons acting on its or their behalf (collectively, "Vishay"), disclaim any and all liability for any errors, inaccuracies or incompleteness contained in any datasheet or in any other disclosure relating to any product.

Vishay makes no warranty, representation or guarantee regarding the suitability of the products for any particular purpose or the continuing production of any product. To the maximum extent permitted by applicable law, Vishay disclaims (i) any and all liability arising out of the application or use of any product, (ii) any and all liability, including without limitation special, consequential or incidental damages, and (iii) any and all implied warranties, including warranties of fitness for particular purpose, non-infringement and merchantability.

Statements regarding the suitability of products for certain types of applications are based on Vishay's knowledge of typical requirements that are often placed on Vishay products in generic applications. Such statements are not binding statements about the suitability of products for a particular application. It is the customer's responsibility to validate that a particular product with the properties described in the product specification is suitable for use in a particular application. Parameters provided in datasheets and / or specifications may vary in different applications and performance may vary over time. All operating parameters, including typical parameters, must be validated for each customer application by the customer's technical experts. Product specifications do not expand or otherwise modify Vishay's terms and conditions of purchase, including but not limited to the warranty expressed therein.

Except as expressly indicated in writing, Vishay products are not designed for use in medical, life-saving, or life-sustaining applications or for any other application in which the failure of the Vishay product could result in personal injury or death. Customers using or selling Vishay products not expressly indicated for use in such applications do so at their own risk. Please contact authorized Vishay personnel to obtain written terms and conditions regarding products designed for such applications.

No license, express or implied, by estoppel or otherwise, to any intellectual property rights is granted by this document or by any conduct of Vishay. Product names and markings noted herein may be trademarks of their respective owners.

X-ON Electronics

Largest Supplier of Electrical and Electronic Components

Click to view similar products for [MOSFET](#) category:

Click to view products by [Vishay](#) manufacturer:

Other Similar products are found below :

[614233C](#) [648584F](#) [IRFD120](#) [JANTX2N5237](#) [FCA20N60_F109](#) [FDZ595PZ](#) [2SK2545\(Q,T\)](#) [405094E](#) [423220D](#) [TPCC8103,L1Q\(CM](#)
[MIC4420CM-TR](#) [VN1206L](#) [SBVS138LT1G](#) [614234A](#) [715780A](#) [NTNS3166NZT5G](#) [SSM6J414TU,LF\(T](#) [751625C](#) [BUK954R8-60E](#)
[DMN3404LQ-7](#) [NTE6400](#) [SQJ402EP-T1-GE3](#) [2SK2614\(TE16L1,Q\)](#) [2N7002KW-FAI](#) [DMN1017UCP3-7](#) [EFC2J004NUZTDG](#) [ECH8691-](#)
[TL-W](#) [FCAB21350L1](#) [P85W28HP2F-7071](#) [DMN1053UCP4-7](#) [NTE221](#) [NTE2384](#) [NTE2903](#) [NTE2941](#) [NTE2945](#) [NTE2946](#) [NTE2960](#)
[NTE2967](#) [NTE2969](#) [NTE2976](#) [NTE455](#) [NTE6400A](#) [NTE2910](#) [NTE2916](#) [NTE2956](#) [NTE2911](#) [DMN2080UCB4-7](#) [TK10A80W,S4X\(S](#)
[SSM6P69NU,LF](#) [DMP22D4UFO-7B](#)