

Silicon PIN Photodiode



DESCRIPTION

TEFD4300 is a silicon PIN photodiode with high radiant sensitivity in clear, T-1 plastic package. It is sensitive to visible and near infrared radiation.

FEATURES

- Package type: leaded
- Package form: T-1
- Dimensions (in mm): $\varnothing 3$
- High radiant sensitivity
- Suitable for visible and near infrared radiation
- Fast response times
- Angle of half sensitivity: $\varphi = \pm 20^\circ$
- Package matched with IR emitter series VSLB3940, TSUS4300, and TSAL4400
- Compliant to RoHS Directive 2002/95/EC and in accordance to WEEE 2002/96/EC



Note

** Please see document "Vishay Material Category Policy":
www.vishay.com/doc?99902

APPLICATIONS

- High speed photo detector for data transmission
- Optical switches
- Counters and sorters
- Interrupters
- Encoders
- Position sensors

PRODUCT SUMMARY			
COMPONENT	I_{ra} (μA)	φ (deg)	$\lambda_{0.1}$ (nm)
TEFD4300	17	± 20	350 to 1120

Note

- Test condition see table "Basic Characteristics"

ORDERING INFORMATION			
ORDERING CODE	PACKAGING	REMARKS	PACKAGE FORM
TEFD4300	Bulk	MOQ: 5000 pcs, 5000 pcs/bulk	T-1

Note

- MOQ: minimum order quantity

ABSOLUTE MAXIMUM RATINGS ($T_{amb} = 25^\circ C$, unless otherwise specified)				
PARAMETER	TEST CONDITION	SYMBOL	VALUE	UNIT
Reverse voltage		V_R	60	V
Power dissipation	$T_{amb} \leq 25^\circ C$	P_V	215	mW
Junction temperature		T_j	100	$^\circ C$
Operating temperature range		T_{amb}	- 40 to + 100	$^\circ C$
Storage temperature range		T_{stg}	- 40 to + 100	$^\circ C$
Soldering temperature	$t \leq 3$ s, 2 mm from case	T_{sd}	260	$^\circ C$
Thermal resistance junction/ambient	Connected with Cu wire, 0.14 mm ²	R_{thJA}	450	K/W

BASIC CHARACTERISTICS ($T_{amb} = 25\text{ }^{\circ}\text{C}$, unless otherwise specified)						
PARAMETER	TEST CONDITION	SYMBOL	MIN.	TYP.	MAX.	UNIT
Forward voltage	$I_F = 50\text{ mA}$	V_F		1		V
Breakdown voltage	$I_R = 100\text{ }\mu\text{A}$, $E = 0$	$V_{(BR)}$	60			V
Reverse dark current	$V_R = 10\text{ V}$, $E = 0$	I_{r0}		0.15	3	nA
Diode capacitance	$V_R = 0\text{ V}$, $f = 1\text{ MHz}$, $E = 0$	C_D		3.3		pF
	$V_R = 5\text{ V}$, $f = 1\text{ MHz}$, $E = 0$	C_D		1.2		pF
Open circuit voltage	$E_e = 1\text{ mW/cm}^2$, $\lambda = 950\text{ nm}$	V_O		350		mV
Temperature coefficient of V_O	$E_e = 1\text{ mW/cm}^2$, $\lambda = 950\text{ nm}$	TK_{V_O}		-2.6		mV/K
Short circuit current	$E_e = 1\text{ mW/cm}^2$, $\lambda = 950\text{ nm}$	I_k		15		μA
Temperature coefficient of I_k	$E_e = 1\text{ mW/cm}^2$, $\lambda = 950\text{ nm}$	TK_{I_k}		0.1		%/K
Reverse light current	$E_e = 1\text{ mW/cm}^2$, $\lambda = 950\text{ nm}$, $V_R = 5\text{ V}$	I_{ra}	9	17	27	μA
Angle of half sensitivity		ϕ		± 20		deg
Wavelength of peak sensitivity		λ_p		950		nm
Range of spectral bandwidth		$\lambda_{0.1}$	350		1120	nm
Rise time	$V_R = 10\text{ V}$, $R_L = 1\text{ k}\Omega$, $\lambda = 820\text{ nm}$	t_r		100		ns
Fall time	$V_R = 10\text{ V}$, $R_L = 1\text{ k}\Omega$, $\lambda = 820\text{ nm}$	t_f		100		ns

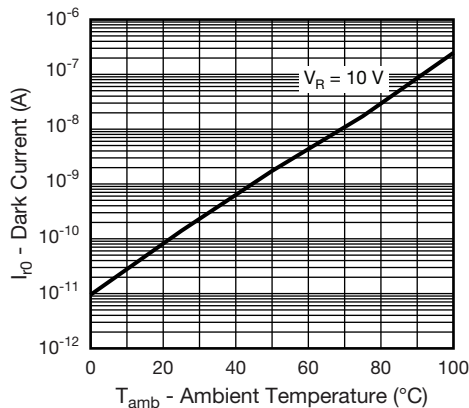
BASIC CHARACTERISTICS ($T_{amb} = 25\text{ }^{\circ}\text{C}$, unless otherwise specified)


Fig. 1 - Reverse Dark Current vs. Ambient Temperature

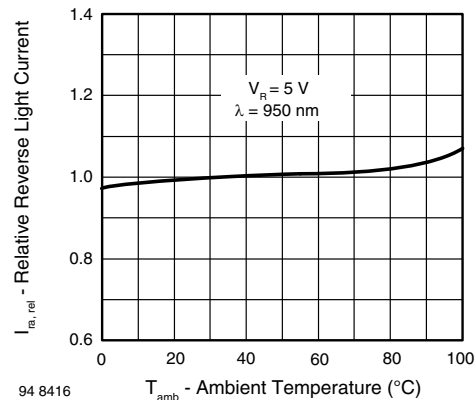


Fig. 2 - Relative Reverse Light Current vs. Ambient Temperature

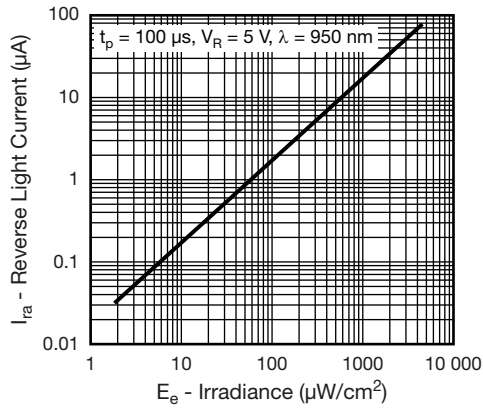


Fig. 3 - Reverse Light Current vs. Irradiance

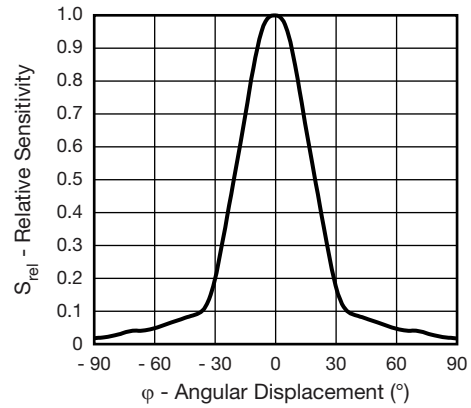


Fig. 6 - Relative Radiant Intensity vs. Angular Displacement

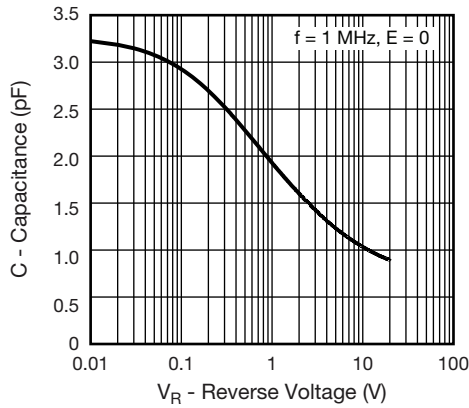


Fig. 4 - Diode Capacitance vs. Reverse Voltage

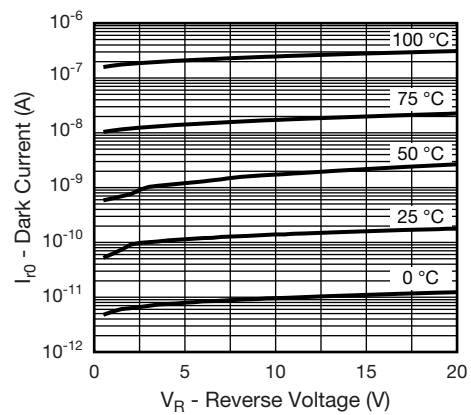


Fig. 7 - Dark Current vs. Reverse Voltage

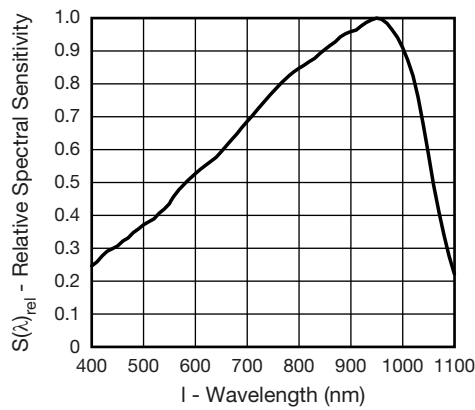
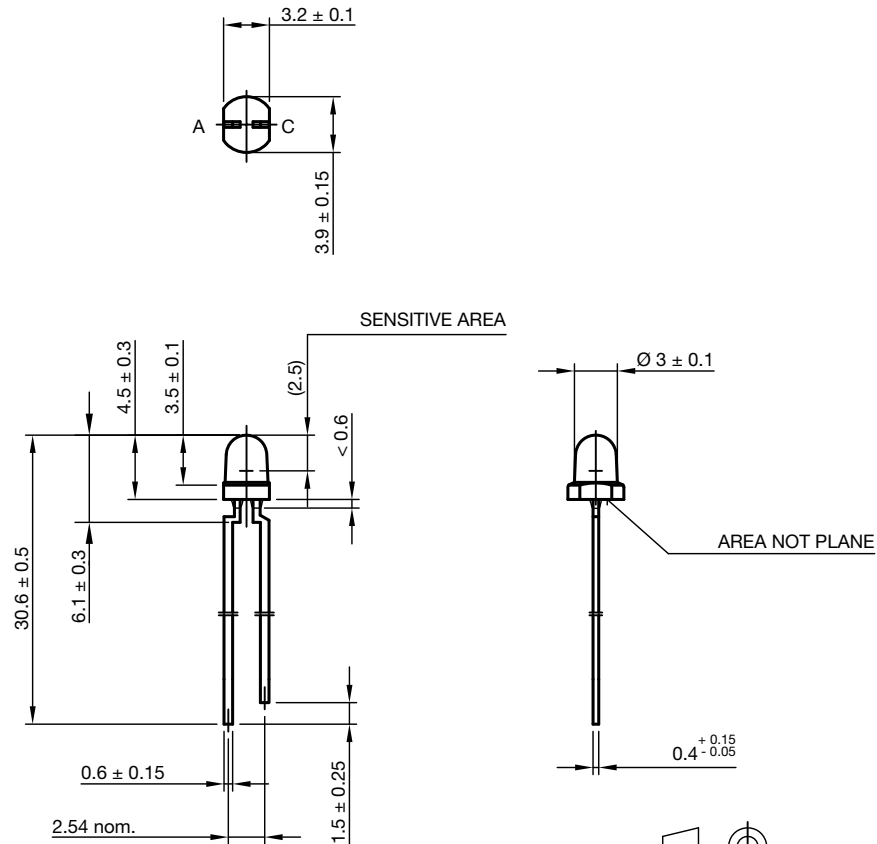


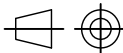
Fig. 5 - Relative Spectral Sensitivity vs. Wavelength



PACKAGE DIMENSIONS in millimeters



Drawing-No.: 6.544-5411.01-4
 Issue: 1; 25.05.11
 22618


 technical drawings
 according to DIN
 specifications



Disclaimer

ALL PRODUCT, PRODUCT SPECIFICATIONS AND DATA ARE SUBJECT TO CHANGE WITHOUT NOTICE TO IMPROVE RELIABILITY, FUNCTION OR DESIGN OR OTHERWISE.

Vishay Intertechnology, Inc., its affiliates, agents, and employees, and all persons acting on its or their behalf (collectively, "Vishay"), disclaim any and all liability for any errors, inaccuracies or incompleteness contained in any datasheet or in any other disclosure relating to any product.

Vishay makes no warranty, representation or guarantee regarding the suitability of the products for any particular purpose or the continuing production of any product. To the maximum extent permitted by applicable law, Vishay disclaims (i) any and all liability arising out of the application or use of any product, (ii) any and all liability, including without limitation special, consequential or incidental damages, and (iii) any and all implied warranties, including warranties of fitness for particular purpose, non-infringement and merchantability.

Statements regarding the suitability of products for certain types of applications are based on Vishay's knowledge of typical requirements that are often placed on Vishay products in generic applications. Such statements are not binding statements about the suitability of products for a particular application. It is the customer's responsibility to validate that a particular product with the properties described in the product specification is suitable for use in a particular application. Parameters provided in datasheets and / or specifications may vary in different applications and performance may vary over time. All operating parameters, including typical parameters, must be validated for each customer application by the customer's technical experts. Product specifications do not expand or otherwise modify Vishay's terms and conditions of purchase, including but not limited to the warranty expressed therein.

Except as expressly indicated in writing, Vishay products are not designed for use in medical, life-saving, or life-sustaining applications or for any other application in which the failure of the Vishay product could result in personal injury or death. Customers using or selling Vishay products not expressly indicated for use in such applications do so at their own risk. Please contact authorized Vishay personnel to obtain written terms and conditions regarding products designed for such applications.

No license, express or implied, by estoppel or otherwise, to any intellectual property rights is granted by this document or by any conduct of Vishay. Product names and markings noted herein may be trademarks of their respective owners.

X-ON Electronics

Largest Supplier of Electrical and Electronic Components

Click to view similar products for [Photodiodes](#) category:

Click to view products by [Vishay](#) manufacturer:

Other Similar products are found below :

[LTR-526AD](#) [OED-SP-7L](#) [LTR-536AB](#) [67-21SYGC-S349-TR8](#) [SFH 2200 A01](#) [HFD3081-108-XBA](#) [BPW 34 S E9601](#) [SFH 2713](#) [SFH 2703](#)
[LTR-546AD](#) [BPV23FL](#) [BPW 34 FAS](#) [BPW 34 FS](#) [IG17X1000S4I](#) [IG22X250S4I](#) [VTD205H](#) [VTD205KH](#) [VTP1232FH](#) [VTP4085H](#) [SFH](#)
[2400](#) [OP913WSL](#) [OPF794](#) [PD70-01C/TR7](#) [LTR-536AD](#) [VTP8651H](#) [VTD206KH](#) [VTB1013H](#) [BPV23NF](#) [OP905](#) [LTR-516AD](#) [BPW 34](#)
[FS-Z](#) [VTD34FH](#) [QSB34CGR](#) [SFH 2500 FA](#) [SFH 213 FA](#) [PD15-22C/TR8](#) [VEMD5510C](#) [SFH 2200](#) [VEMD5510CF](#) [SAH230M](#) [SAH230M2](#)
[SAH500M2](#) [MTAPD-07-010](#) [BP 104 FS](#) [BPV22F-AS12](#) [BPW 21](#) [BPW 34 SR-Z](#) [BPX 65](#) [HSDL-5400#011](#) [BPW 34 FASR](#)