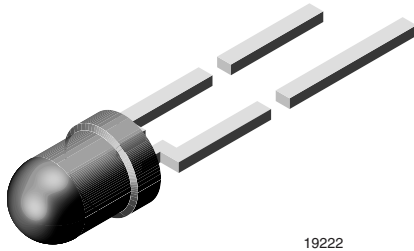


High Intensity LED in Ø 3 mm Tinted Non-Diffused Package



19222

DESCRIPTION

This device has been designed to meet the increasing demand for AllnGaP technology.

It is housed in a 3 mm clear plastic package. The small viewing angle of these devices provides a high brightness.

All packing units are categorized in luminous intensity and color groups. That allows users to assemble LEDs with uniform appearance.

PRODUCT GROUP AND PACKAGE DATA

- Product group: LED
- Package: 3 mm
- Product series: standard
- Angle of half intensity: $\pm 22^\circ$

FEATURES

- AllnGaP technology
- Standard Ø 3 mm (T-1) package
- Small mechanical tolerances
- Suitable for DC and high peak current
- Small viewing angle
- Very high intensity
- Luminous intensity color categorized
- Material categorization:
for definitions of compliance please see www.vishay.com/doc?99912



APPLICATIONS

- Status lights
- Off / on indicator
- Background illumination
- Readout lights
- Maintenance lights
- Legend light

PARTS TABLE														
PART	COLOR	LUMINOUS INTENSITY (mcd)			at I _F (mA)	WAVELENGTH (nm)			at I _F (mA)	FORWARD VOLTAGE (V)			at I _F (mA)	TECHNOLOGY
		MIN.	TYP.	MAX.		MIN.	TYP.	MAX.		MIN.	TYP.	MAX.		
TLHK4200	Red	25	100	-	10	-	630	-	10	-	1.9	2.6	20	AllnGaP on GaAs

ABSOLUTE MAXIMUM RATINGS (T _{amb} = 25 °C, unless otherwise specified)				
TLHK4200				
PARAMETER	TEST CONDITION	SYMBOL	VALUE	UNIT
Reverse voltage		V _R	5	V
DC forward current	T _{amb} ≤ 60 °C	I _F	30	mA
Surge forward current	t _p ≤ 10 μs	I _{FSM}	0.1	A
Power dissipation	T _{amb} ≤ 60 °C	P _V	80	mW
Junction temperature		T _j	100	°C
Operating temperature range		T _{amb}	-40 to +100	°C
Storage temperature range		T _{stg}	-55 to +100	°C
Soldering temperature	t ≤ 5 s, 2 mm from body	T _{sd}	260	°C
Thermal resistance junction/ambient		R _{thJA}	400	K/W

OPTICAL AND ELECTRICAL CHARACTERISTICS ($T_{amb} = 25\text{ }^{\circ}\text{C}$, unless otherwise specified)						
TLHK4200, RED						
PARAMETER	TEST CONDITION	SYMBOL	MIN	TYP.	MAX	UNIT
Luminous intensity ⁽¹⁾	$I_F = 10\text{ mA}$	I_V	25	100	-	mcd
Dominant wavelength	$I_F = 10\text{ mA}$	λ_d	-	630	-	nm
Peak wavelength	$I_F = 10\text{ mA}$	λ_p	-	643	-	nm
Angle of half intensity	$I_F = 10\text{ mA}$	ϕ	-	± 22	-	$^{\circ}$
Forward voltage	$I_F = 20\text{ mA}$	V_F	-	1.9	2.6	V
Reverse voltage	$I_R = 10\text{ }\mu\text{A}$	V_R	5	-	-	V
Junction capacitance	$V_R = 0\text{ V}$, $f = 1\text{ MHz}$	C_j	-	15	-	pF

Note

(1) In one packing unit $I_{Vmin}/I_{Vmax} \leq 0.5$

LUMINOUS INTENSITY CLASSIFICATION			
GROUP	LIGHT INTENSITY (mcd)		
	STANDARD	MIN.	MAX.
T	25	50	
U	40	80	
V	63	125	
W	100	200	
X	130	260	
Y	180	360	
Z	240	480	

Note

- Luminous intensity is tested at a current pulse duration of 25 ms. The above type numbers represent the order groups which include only a few brightness groups. Only one group will be shipped on each bag (there will be no mixing of two groups on each bag). In order to ensure availability, single brightness groups will not be orderable. In a similar manner for colors where wavelength groups are measured and binned, single wavelength groups will be shipped on any one bag. In order to ensure availability, single wavelength groups will not be orderable.

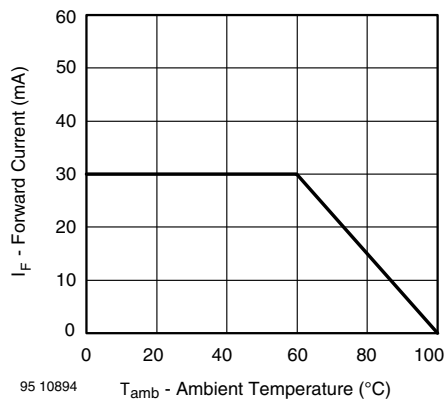
TYPICAL CHARACTERISTICS ($T_{amb} = 25\text{ }^{\circ}\text{C}$, unless otherwise specified)


Fig. 1 - Forward Current vs. Ambient Temperature for InGaN

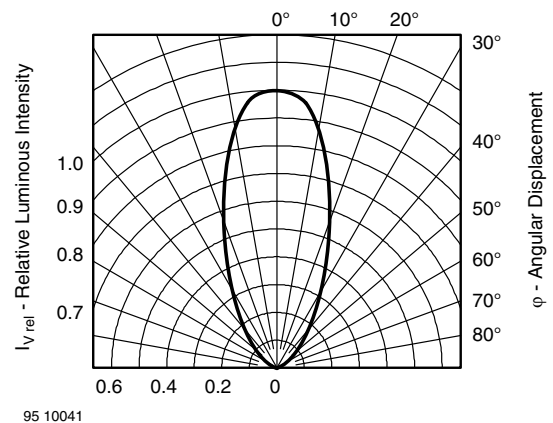


Fig. 2 - Relative Luminous Intensity vs. Angular Displacement

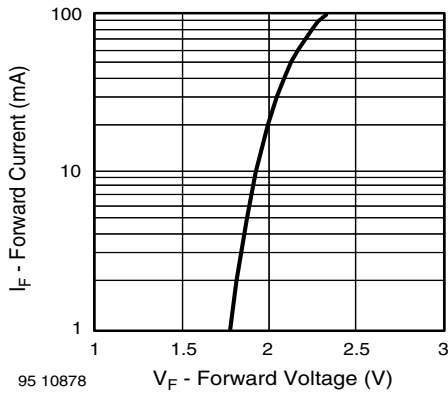


Fig. 3 - Forward Current vs. Forward Voltage

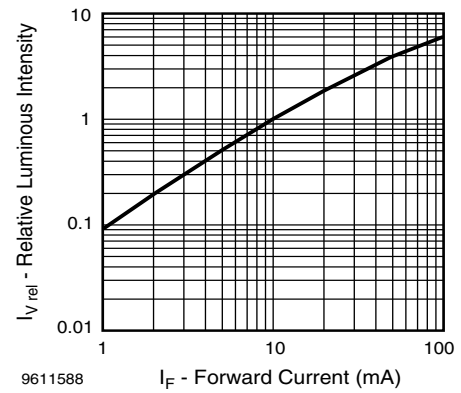


Fig. 6 - Relative Luminous Intensity vs. Forward Current

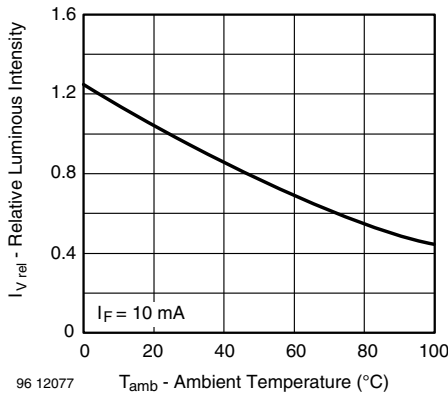


Fig. 4 - Relative Luminous Intensity vs. Ambient Temperature

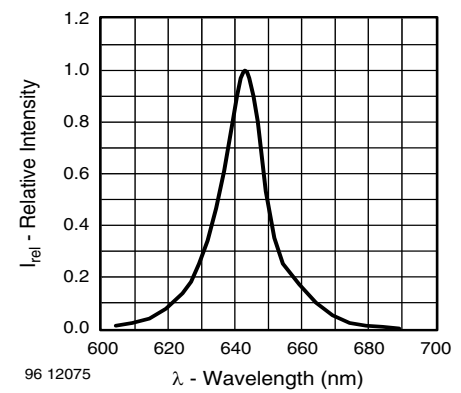


Fig. 7 - Relative Intensity vs. Wavelength

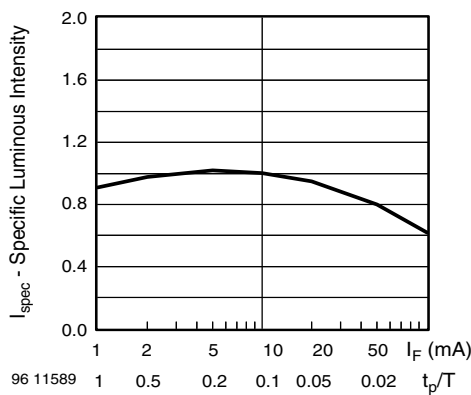
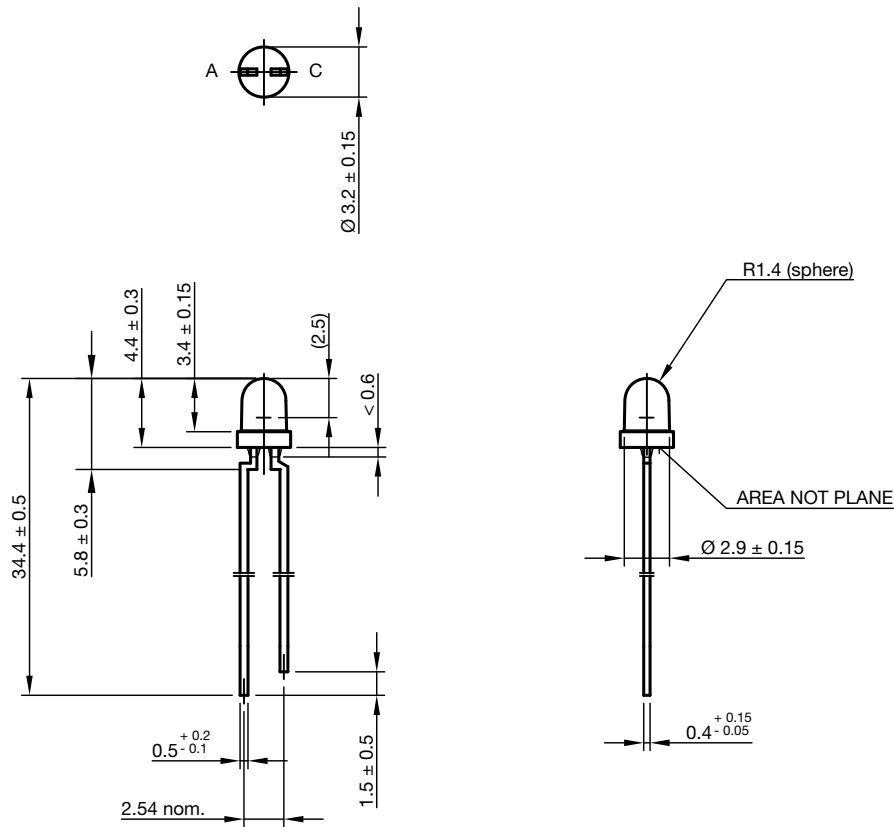


Fig. 5 - Relative Luminous Intensity vs. Forward Current/Duty Cycle



PACKAGE DIMENSIONS in millimeters



technical drawings
according to DIN
specifications

Drawing-No.: 6.544-5255.01-4
Issue: 9; 28.07.14



Disclaimer

ALL PRODUCT, PRODUCT SPECIFICATIONS AND DATA ARE SUBJECT TO CHANGE WITHOUT NOTICE TO IMPROVE RELIABILITY, FUNCTION OR DESIGN OR OTHERWISE.

Vishay Intertechnology, Inc., its affiliates, agents, and employees, and all persons acting on its or their behalf (collectively, "Vishay"), disclaim any and all liability for any errors, inaccuracies or incompleteness contained in any datasheet or in any other disclosure relating to any product.

Vishay makes no warranty, representation or guarantee regarding the suitability of the products for any particular purpose or the continuing production of any product. To the maximum extent permitted by applicable law, Vishay disclaims (i) any and all liability arising out of the application or use of any product, (ii) any and all liability, including without limitation special, consequential or incidental damages, and (iii) any and all implied warranties, including warranties of fitness for particular purpose, non-infringement and merchantability.

Statements regarding the suitability of products for certain types of applications are based on Vishay's knowledge of typical requirements that are often placed on Vishay products in generic applications. Such statements are not binding statements about the suitability of products for a particular application. It is the customer's responsibility to validate that a particular product with the properties described in the product specification is suitable for use in a particular application. Parameters provided in datasheets and / or specifications may vary in different applications and performance may vary over time. All operating parameters, including typical parameters, must be validated for each customer application by the customer's technical experts. Product specifications do not expand or otherwise modify Vishay's terms and conditions of purchase, including but not limited to the warranty expressed therein.

Except as expressly indicated in writing, Vishay products are not designed for use in medical, life-saving, or life-sustaining applications or for any other application in which the failure of the Vishay product could result in personal injury or death. Customers using or selling Vishay products not expressly indicated for use in such applications do so at their own risk. Please contact authorized Vishay personnel to obtain written terms and conditions regarding products designed for such applications.

No license, express or implied, by estoppel or otherwise, to any intellectual property rights is granted by this document or by any conduct of Vishay. Product names and markings noted herein may be trademarks of their respective owners.

X-ON Electronics

Largest Supplier of Electrical and Electronic Components

Click to view similar products for [Standard LEDs - Through Hole category](#):

Click to view products by [Vishay manufacturer](#):

Other Similar products are found below :

[LTL-10254W](#) [LTL-1214A](#) [LTL-3251A](#) [LTL-4262N](#) [LTL-433P](#) [LTL-5234](#) [LTL87HTBK](#) [LTL-87HD4B](#) [HLMP-EL30-PS0DD](#)
[1L0532V23G0TD001](#) [NSPW500CS](#) [NTE30036](#) [NTE30044](#) [NTE30059](#) [NTE3020](#) [LD CQDP-1U3U-W5-1-K](#) [LO566UHR3-70G-A3](#)
[LP379PPG1C0G0300001](#) [SLX-LX3044GD](#) [SLX-LX3044ID](#) [SLX-LX3044YD](#) [1.90690.3330000](#) [SSS-LX4673ID-410B](#) [1L0532Y24I0TD001](#)
[264-7SYGD/S530-E2](#) [HLMP-1301-G00FG](#) [HLMP1385](#) [LTL-10224W](#) [LTL-1224A](#) [LTL-1234A](#) [LTL-2251AT](#) [LTL-403HR](#) [LTL-4222](#)
[LU7-E-B](#) [4380H1](#) [TLHY44K1L2](#) [484-10SYGT/S530-E2](#) [HLMP-3962-F0002](#) [HLMP-GG15-R0000](#) [323-2SURD/S530-A3](#) [L53SRC/E-Z](#) [L-](#)
[7679C1ZGC](#) [4302T1-5V](#) [4306D23](#) [4363D1/5](#) [WP1503SRC/J4](#) [WP153GDT](#) [WP153YDT](#) [WP1543SGC](#) [WP1543SURC](#)