

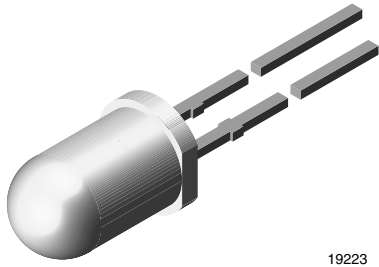

High Intensity LED, Ø 5 mm Untinted Non-Diffused Package



19223

DESCRIPTION

The TLH.51.. series is a clear, non diffused 5 mm LED for outdoor application.

These clear lamps utilize the highly developed technologies like AlInGaP and GaP.

The lens and the viewing angle is optimized to achieve best performance of light output and visibility.

FEATURES

- Untinted non-diffused lens
• Choice of two colors
• TLH.5100 for cost effective design
• Medium viewing angle
• Material categorization: for definitions of compliance please see www.vishay.com/doc?99912



APPLICATIONS

- Outdoor LED panels
• Central high mounted stop lights (CHMSL) for motor vehicles
• Instrumentation and front panel indicators
• Light guide design
• Traffic signals

PRODUCT GROUP AND PACKAGE DATA

- Product group: LED
• Package: 5 mm
• Product series: standard
• Angle of half intensity: ± 9°

Table with 14 columns: PART, COLOR, LUMINOUS INTENSITY (mcd) [MIN., TYP., MAX.], at IF (mA), WAVELENGTH (nm) [MIN., TYP., MAX.], at IF (mA), FORWARD VOLTAGE (V) [MIN., TYP., MAX.], at IF (mA), TECHNOLOGY. Rows include TLHK5100 (Red) and TLHE5100 (Yellow).

Table with 5 columns: PARAMETER, TEST CONDITION, SYMBOL, VALUE, UNIT. Title: ABSOLUTE MAXIMUM RATINGS (Tamb = 25 °C, unless otherwise specified) TLHK510., TLHE510. Rows include Reverse voltage, DC forward current, Surge forward current, Power dissipation, Junction temperature, Operating temperature range, Storage temperature range, Soldering temperature, Thermal resistance junction-to-ambient.



| <b>OPTICAL AND ELECTRICAL CHARACTERISTICS</b> ( $T_{amb} = 25\text{ }^{\circ}\text{C}$ , unless otherwise specified) |                                      |             |      |         |      |            |
|--|--------------------------------------|-------------|------|---------|------|------------|
| <b>TLHK510., RED</b>   |                                      |             |      |         |      |            |
| PARAMETER  | TEST CONDITION                       | SYMBOL      | MIN. | TYP.    | MAX. | UNIT       |
| Luminous intensity <sup>(1)</sup>  | $I_F = 20\text{ mA}$                 | $I_V$       | 320  | 1400    | -    | mcd        |
| Dominant wavelength  | $I_F = 10\text{ mA}$                 | $\lambda_d$ | 626  | 630     | 639  | nm         |
| Peak wavelength  | $I_F = 10\text{ mA}$                 | $\lambda_p$ | -    | 643     | -    | nm         |
| Angle of half intensity  | $I_F = 10\text{ mA}$                 | $\phi$      | -    | $\pm 9$ | -    | $^{\circ}$ |
| Forward voltage  | $I_F = 20\text{ mA}$                 | $V_F$       | -    | 2       | 2.6  | V          |
| Reverse voltage  | $I_R = 10\text{ }\mu\text{A}$        | $V_R$       | 5    | -       | -    | V          |
| Junction capacitance   | $V_R = 0\text{ V}, f = 1\text{ MHz}$ | $C_j$       | -    | 15      | -    | pF         |

**Note**

<sup>(1)</sup> In one packing unit  $I_{Vmin.}/I_{Vmax.} \leq 0.5$

| <b>OPTICAL AND ELECTRICAL CHARACTERISTICS</b> ( $T_{amb} = 25\text{ }^{\circ}\text{C}$ , unless otherwise specified) |                                      |             |      |         |      |            |
|--|--------------------------------------|-------------|------|---------|------|------------|
| <b>TLHE510., YELLOW</b>  |                                      |             |      |         |      |            |
| PARAMETER  | TEST CONDITION                       | SYMBOL      | MIN. | TYP.    | MAX. | UNIT       |
| Luminous intensity <sup>(1)</sup>  | $I_F = 20\text{ mA}$                 | $I_V$       | 750  | 1800    | -    | mcd        |
| Dominant wavelength  | $I_F = 10\text{ mA}$                 | $\lambda_d$ | 581  | 588     | 594  | nm         |
| Peak wavelength  | $I_F = 10\text{ mA}$                 | $\lambda_p$ | -    | 590     | -    | nm         |
| Angle of half intensity  | $I_F = 10\text{ mA}$                 | $\phi$      | -    | $\pm 9$ | -    | $^{\circ}$ |
| Forward voltage  | $I_F = 20\text{ mA}$                 | $V_F$       | -    | 2       | 2.6  | V          |
| Reverse voltage  | $I_R = 10\text{ }\mu\text{A}$        | $V_R$       | 5    | -       | -    | V          |
| Junction capacitance   | $V_R = 0\text{ V}, f = 1\text{ MHz}$ | $C_j$       | -    | 15      | -    | pF         |

**Note**

<sup>(1)</sup> In one packing unit  $I_{Vmin.}/I_{Vmax.} \leq 0.5$

| <b>LUMINOUS INTENSITY CLASSIFICATION</b> |                       |      |
|--|-----------------------|------|
| GROUP                                    | LIGHT INTENSITY (mcd) |      |
|  | MIN.                  | MAX. |
| Z  | 240                   | 480  |
| AA                                       | 320                   | 640  |
| BB                                       | 430                   | 860  |
| CC                                       | 575                   | 1150 |
| DD                                       | 750                   | 1500 |
| EE                                       | 1000                  | 2000 |
| FF                                       | 1350                  | 2700 |
| GG                                       | 1800                  | 3600 |
| HH                                       | 2400                  | 4800 |
| II                                       | 3200                  | 6400 |
| KK                                       | 4300                  | 8600 |

**Note**

- Luminous intensity is tested at a current pulse duration of 25 ms. The above type numbers represent the order groups which include only a few brightness groups. Only one group will be shipped on each bag (there will be no mixing of two groups on each bag).  
In order to ensure availability, single brightness groups will not be orderable.  
In a similar manner for colors where wavelength groups are measured and binned, single wavelength groups will be shipped in any one bag.  
In order to ensure availability, single wavelength groups will not be orderable

| <b>COLOR CLASSIFICATION</b> |                      |      |
|-----------------------------|----------------------|------|
| GROUP                       | DOM. WAVELENGTH (nm) |      |
|                             | YELLOW               |      |
|                             | MIN.                 | MAX. |
| 1                           | 581                  | 584  |
| 2                           | 583                  | 586  |
| 3                           | 585                  | 588  |
| 4                           | 587                  | 590  |
| 5                           | 589                  | 592  |
| 6                           | 591                  | 594  |

**Note**

- Wavelengths are tested at a current pulse duration of 25 ms

**TYPICAL CHARACTERISTICS** ( $T_{amb} = 25\text{ }^{\circ}\text{C}$ , unless otherwise specified)

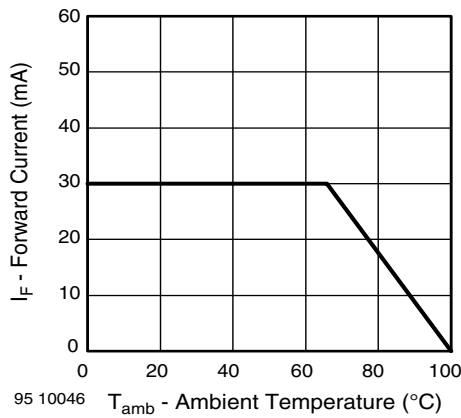

Fig. 1 - Forward Current vs. Ambient Temperature

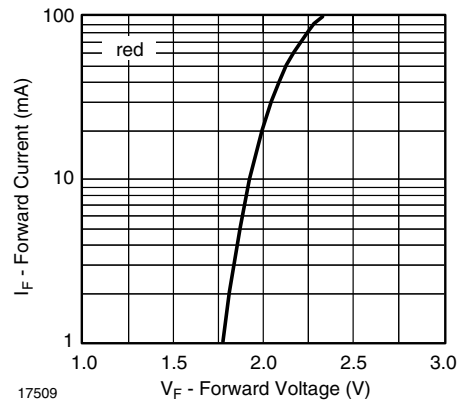

Fig. 4 - Forward Current vs. Forward Voltage

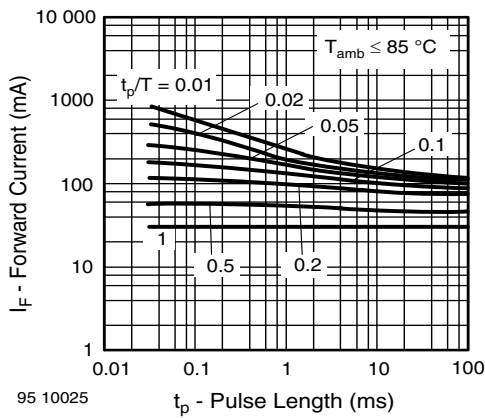

Fig. 2 - Forward Current vs. Pulse Length

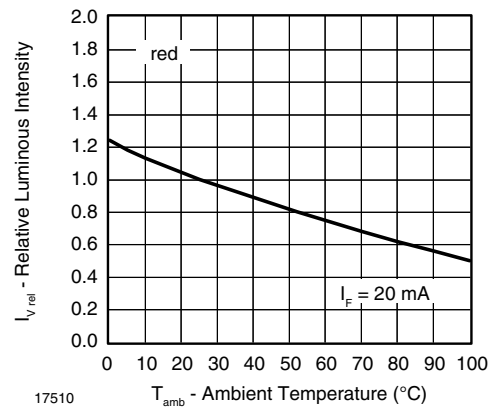

Fig. 5 - Relative Luminous Intensity vs. Ambient Temperature

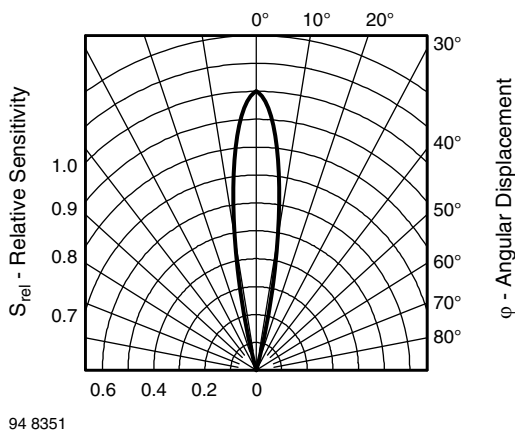

Fig. 3 - Relative Radiant Sensitivity vs. Angular Displacement

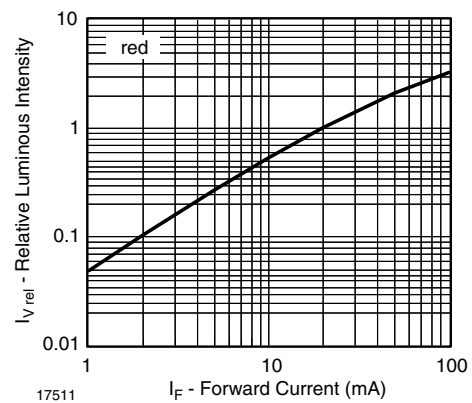

Fig. 6 - Relative Luminous Intensity vs. Forward Current

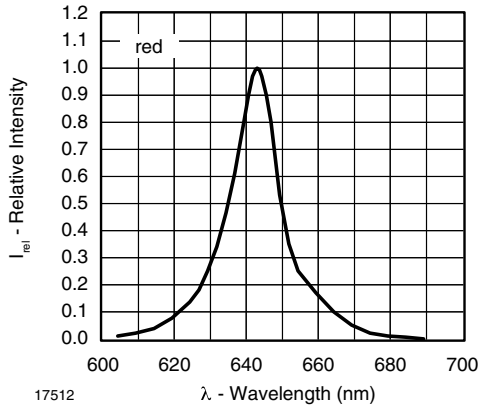

Fig. 7 - Relative Intensity vs. Wavelength

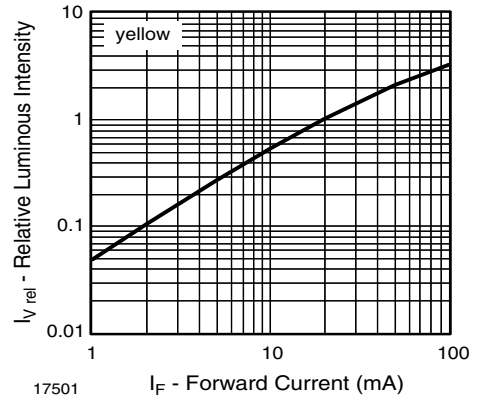

Fig. 10 - Relative Luminous Intensity vs. Forward Current

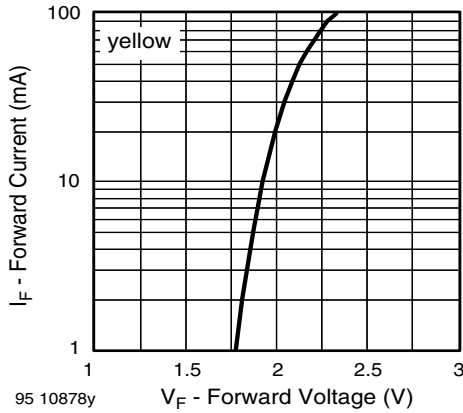

Fig. 8 - Forward Current vs. Forward Voltage

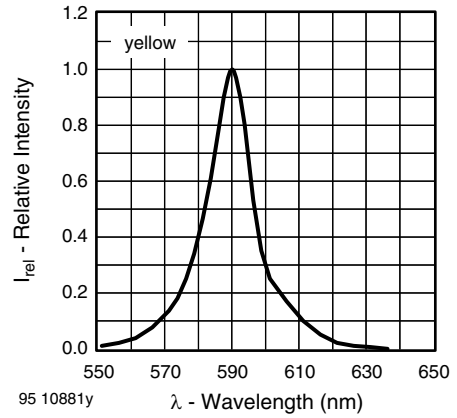

Fig. 11 - Relative Intensity vs. Wavelength

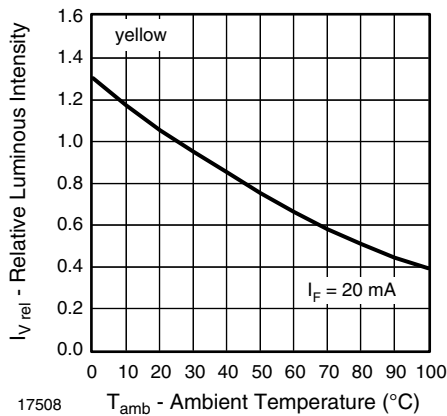

Fig. 9 - Relative Luminous Intensity vs. Ambient Temperature

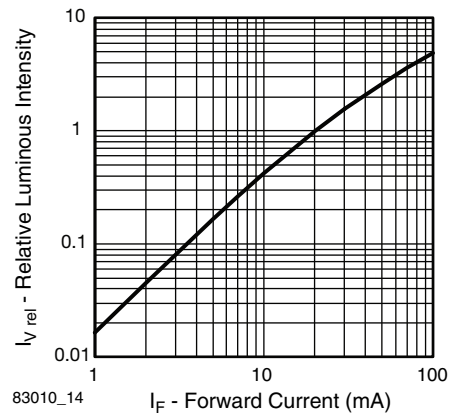
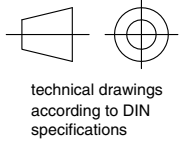
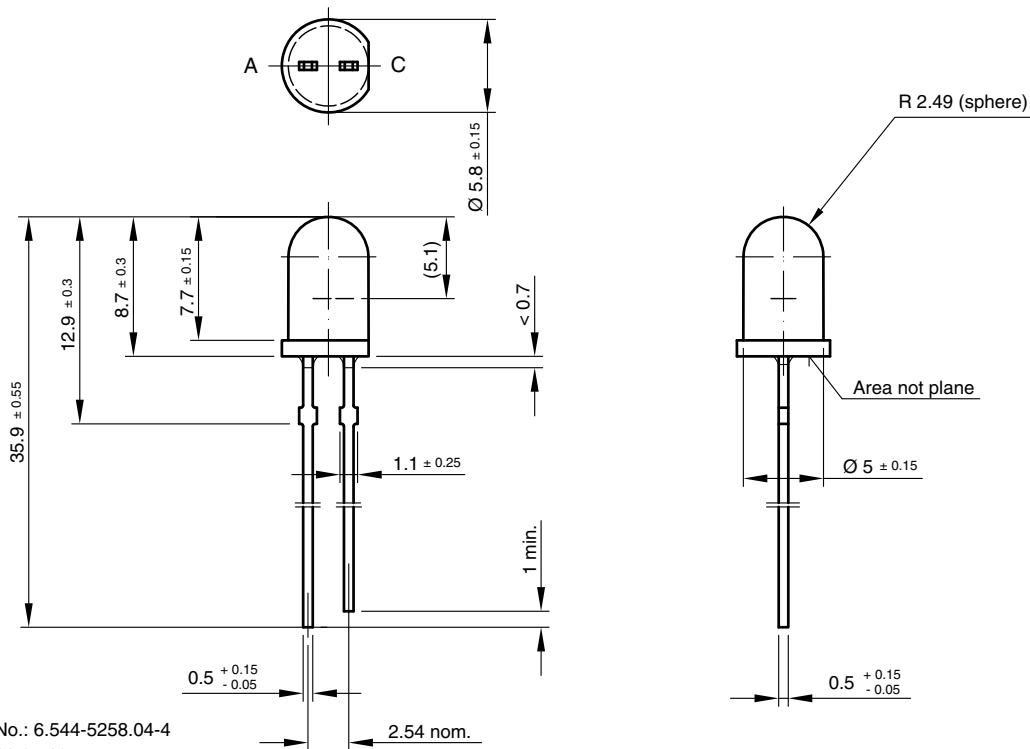

Fig. 12 - Relative Luminous Intensity vs. Forward Current



## PACKAGE DIMENSIONS in millimeters



Drawing-No.: 6.544-5258.04-4  
 Issue: 9; 23.07.10  
 96 12121



## Disclaimer

ALL PRODUCT, PRODUCT SPECIFICATIONS AND DATA ARE SUBJECT TO CHANGE WITHOUT NOTICE TO IMPROVE RELIABILITY, FUNCTION OR DESIGN OR OTHERWISE.

Vishay Intertechnology, Inc., its affiliates, agents, and employees, and all persons acting on its or their behalf (collectively, "Vishay"), disclaim any and all liability for any errors, inaccuracies or incompleteness contained in any datasheet or in any other disclosure relating to any product.

Vishay makes no warranty, representation or guarantee regarding the suitability of the products for any particular purpose or the continuing production of any product. To the maximum extent permitted by applicable law, Vishay disclaims (i) any and all liability arising out of the application or use of any product, (ii) any and all liability, including without limitation special, consequential or incidental damages, and (iii) any and all implied warranties, including warranties of fitness for particular purpose, non-infringement and merchantability.

Statements regarding the suitability of products for certain types of applications are based on Vishay's knowledge of typical requirements that are often placed on Vishay products in generic applications. Such statements are not binding statements about the suitability of products for a particular application. It is the customer's responsibility to validate that a particular product with the properties described in the product specification is suitable for use in a particular application. Parameters provided in datasheets and / or specifications may vary in different applications and performance may vary over time. All operating parameters, including typical parameters, must be validated for each customer application by the customer's technical experts. Product specifications do not expand or otherwise modify Vishay's terms and conditions of purchase, including but not limited to the warranty expressed therein.

Except as expressly indicated in writing, Vishay products are not designed for use in medical, life-saving, or life-sustaining applications or for any other application in which the failure of the Vishay product could result in personal injury or death. Customers using or selling Vishay products not expressly indicated for use in such applications do so at their own risk. Please contact authorized Vishay personnel to obtain written terms and conditions regarding products designed for such applications.

No license, express or implied, by estoppel or otherwise, to any intellectual property rights is granted by this document or by any conduct of Vishay. Product names and markings noted herein may be trademarks of their respective owners.

## X-ON Electronics

Largest Supplier of Electrical and Electronic Components

*Click to view similar products for [Standard LEDs - Through Hole category](#):*

*Click to view products by [Vishay manufacturer](#):*

Other Similar products are found below :

[LTL-10254W](#) [LTL-1214A](#) [LTL-3251A](#) [LTL-4262N](#) [LTL-433P](#) [LTL-5234](#) [LTL87HTBK](#) [LTW-87HD4B](#) [HLMP-EL30-PS0DD](#)  
[1L0532V23G0TD001](#) [NSPW500CS](#) [NTE30036](#) [NTE30044](#) [NTE30059](#) [NTE3020](#) [LD CQDP-1U3U-W5-1-K](#) [LO566UHR3-70G-A3](#)  
[LP379PPG1C0G0300001](#) [SLR-342MC3F](#) [SLX-LX3044GD](#) [SLX-LX3044ID](#) [SLX-LX3044YD](#) [1.90690.3330000](#) [SSS-LX4673ID-410B](#)  
[1L0532Y24I0TD001](#) [264-7SYGD/S530-E2](#) [HLMP1385](#) [LTL-10224W](#) [LTL-1224A](#) [LTL-1234A](#) [LTL-2251AT](#) [LTL-307YE-012](#) [LTL-](#)  
[403HR](#) [LTL-4222](#) [LU7-E-B](#) [4380H1](#) [TLHY44K1L2](#) [HLMP-3962-F0002](#) [HLMP-GG15-R0000](#) [323-2SURD/S530-A3](#) [L53SRC/E-Z](#) [L-](#)  
[7679C1ZGC](#) [4302T1-5V](#) [4306D23](#) [4363D1/5](#) [WP1503SRC/J4](#) [WP153GDT](#) [WP153YDT](#) [WP1543SGC](#) [WP1543SRC/D](#)