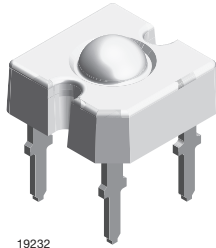




TELUX LED



19232

DESCRIPTION

The TELUX series is a clear, non diffused LED for applications where supreme luminous flux is required.

It is designed in an industry standard 7.62 mm square package utilizing highly developed AlInGaP technology.

The supreme heat dissipation of TELUX allows applications at high ambient temperatures.

All packing units are binned for luminous flux, forward voltage, and color to achieve the most homogenous light appearance in application.

SAE and ECE color requirements for automobile application are available for color red.

PRODUCT GROUP AND PACKAGE DATA

- Product group: LED
- Package: TELUX
- Product series: power
- Angle of half intensity: $\pm 45^\circ$

FEATURES

- High luminous flux
- Supreme heat dissipation: R_{thJP} is 90 K/W
- High operating temperature:
 $T_{amb} = -40^\circ\text{C}$ to $+110^\circ\text{C}$
- Meets SAE and ECE color requirements for the automobile industry for color red
- Packed in tubes for automatic insertion
- Luminous flux, forward voltage, and color categorized for each tube
- Small mechanical tolerances allow precise usage of external reflectors or lightguides
- Compatible with wave solder processes according to CECC 00802
- ESD-withstand voltage: up to 2 kV according to JESD22-A114-B
- AEC-Q101 qualified
- Material categorization: for definitions of compliance please see www.vishay.com/doc?99912

AUTOMOTIVE
GRADERoHS
COMPLIANT
HALOGEN
FREE
GREEN
(5-2008)

APPLICATIONS

- Exterior lighting
- Dashboard illumination
- Tail-, stop-, and turn signals of motor vehicles
- Replaces small incandescent lamps
- Traffic signals and signs

PARTS TABLE

PART	COLOR	LUMINOUS FLUX (mIm)			at I_F (mA)	WAVELENGTH (nm)			at I_F (mA)	FORWARD VOLTAGE (V)			at I_F (mA)	TECHNOLOGY
		MIN.	TYP.	MAX.		MIN.	TYP.	MAX.		MIN.	TYP.	MAX.		
TLWR8900	Red	2000	3700	-	70	611	616	634	70	1.83	2.2	2.67	70	AllnGaP on GaAs
TLWR8901	Red	2000	3700	4800	70	611	616	634	70	1.83	2.2	2.67	70	AllnGaP on GaAs
TLWR8902	Red	3000	3900	4800	70	611	616	634	70	1.95	2.2	2.67	70	AllnGaP on GaAs
TLWY8900	Yellow	2000	3200	-	70	585	591	597	70	1.83	2.1	2.67	70	AllnGaP on GaAs

ABSOLUTE MAXIMUM RATINGS ($T_{amb} = 25^\circ\text{C}$, unless otherwise specified)

TLWR8900, TLWR8901, TLWR8902, TLWY8900

PARAMETER	TEST CONDITION	SYMBOL	VALUE	UNIT
Reverse voltage ⁽¹⁾	$I_R = 100 \mu\text{A}$	V_R	10	V
DC forward current	$T_{amb} \leq 85^\circ\text{C}$	I_F	70	mA
Surge forward current	$t_p \leq 10 \mu\text{s}$	I_{FSM}	1	A
Power dissipation		P_V	187	mW
Junction temperature		T_j	125	$^\circ\text{C}$
Operating temperature range		T_{amb}	-40 to +110	$^\circ\text{C}$
Storage temperature range		T_{stg}	-55 to +110	$^\circ\text{C}$
Soldering temperature	$t \leq 5 \text{ s}$, 1.5 mm from body preheat temperature $100^\circ\text{C} / 30 \text{ s}$	T_{sd}	260	$^\circ\text{C}$
Thermal resistance junction-to-ambient	With cathode heatsink of 70 mm^2	R_{thJA}	200	K/W
Thermal resistance junction-to-pin		R_{thJP}	90	K/W

Note

- ⁽¹⁾ Driving the LED in reverse direction is suitable for a short term application

**OPTICAL AND ELECTRICAL CHARACTERISTICS** ($T_{amb} = 25\text{ }^{\circ}\text{C}$, unless otherwise specified)
TLWR8900, TLWR8901, TLWR8902, RED

PARAMETER	TEST CONDITION	PART	SYMBOL	MIN.	TYP.	MAX.	UNIT
Total flux	$I_F = 70\text{ mA}$, $R_{thJA} = 200\text{ K/W}$	TLWR8900	ϕ_V	2000	3700	-	mlm
	$I_F = 70\text{ mA}$, $R_{thJA} = 200\text{ K/W}$	TLWR8901	ϕ_V	2000	3700	4800	mlm
	$I_F = 70\text{ mA}$, $R_{thJA} = 200\text{ K/W}$	TLWR8902	ϕ_V	3000	3900	4800	mlm
Luminous intensity/total flux			I_V/ϕ_V	-	0.7	-	mcd/mlm
Dominant wavelength			λ_d	611	616	634	nm
Peak wavelength			λ_p	-	624	-	nm
Angle of half intensity			ϕ	-	± 45	-	deg
Total included angle	90 % of total flux captured		$\phi_{0.9V}$	-	100	-	deg
Forward voltage	$I_F = 70\text{ mA}$, $R_{thJA} = 200\text{ K/W}$	TLWR8900	V_F	1.83	2.2	2.67	V
	$I_F = 70\text{ mA}$, $R_{thJA} = 200\text{ K/W}$	TLWR8901	V_F	1.83	2.2	2.67	V
	$I_F = 70\text{ mA}$, $R_{thJA} = 200\text{ K/W}$	TLWR8902	V_F	1.95	2.2	2.67	V
Reverse voltage	$I_R = 10\text{ }\mu\text{A}$		V_R	10	20	-	V
Junction capacitance	$V_R = 0\text{ V}$, $f = 1\text{ MHz}$		C_j	-	17	-	pF

OPTICAL AND ELECTRICAL CHARACTERISTICS ($T_{amb} = 25\text{ }^{\circ}\text{C}$, unless otherwise specified)
TLWY8900, YELLOW

PARAMETER	TEST CONDITION	SYMBOL	MIN.	TYP.	MAX.	UNIT
Total flux	$I_F = 70\text{ mA}$, $R_{thJA} = 200\text{ K/W}$	ϕ_V	2000	3200	-	mlm
Luminous intensity/total flux	$I_F = 70\text{ mA}$, $R_{thJA} = 200\text{ K/W}$	I_V/ϕ_V	-	0.7	-	mcd/mlm
Dominant wavelength	$I_F = 70\text{ mA}$, $R_{thJA} = 200\text{ K/W}$	λ_d	585	591	597	nm
Peak wavelength	$I_F = 70\text{ mA}$, $R_{thJA} = 200\text{ K/W}$	λ_p	-	594	-	nm
Angle of half intensity	$I_F = 70\text{ mA}$, $R_{thJA} = 200\text{ K/W}$	ϕ	-	± 45	-	deg
Total included angle	90 % of total flux captured	$\phi_{0.9V}$	-	100	-	deg
Forward voltage	$I_F = 70\text{ mA}$, $R_{thJA} = 200\text{ K/W}$	V_F	1.83	2.1	2.67	V
Reverse voltage	$I_R = 10\text{ }\mu\text{A}$	V_R	10	15	-	V
Junction capacitance	$V_R = 0\text{ V}$, $f = 1\text{ MHz}$	C_j	-	17	-	pF

LUMINOUS FLUX CLASSIFICATION

GROUP	LUMINOUS FLUX (mlm)	
	MIN.	MAX.
D	2000	3000
E	2500	3600
F	3000	4200
G	3500	4800
H	4000	6100
I	5000	7300
K	6000	9700
L	7000	12 200

Note

- Luminous flux is tested at a current pulse duration of 25 ms and an accuracy of $\pm 11\%$.
These type numbers represent the order groups which include only a few brightness groups. Only one group will be shipped on each tube (there will be no mixing of two groups on each tube). In order to ensure availability, single brightness groups will not be orderable.
In a similar manner for colors where wavelength groups are measured and binned, single wavelength groups will be shipped in any one tube.
In order to ensure availability, single wavelength groups will not be orderable

COLOR CLASSIFICATION				
GROUP	DOM. WAVELENGTH (nm)			
	YELLOW		RED	
	MIN.	MAX.	MIN.	MAX.
0	585	588		
1	587	591	611	618
2	589	594	614	622
3	592	597	616	634

Note

- Wavelengths are tested at a current pulse duration of 25 ms and an accuracy of ± 1 nm

FORWARD VOLTAGE CLASSIFICATION		
GROUP	FORWARD VOLTAGE (V)	
	MIN.	MAX.
Y	1.83	2.07
Z	1.95	2.19
0	2.07	2.31
1	2.19	2.43
2	2.31	2.55
3	2.43	2.67

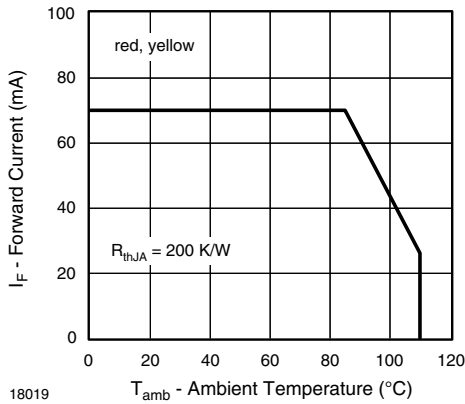
TYPICAL CHARACTERISTICS ($T_{amb} = 25\text{ }^{\circ}\text{C}$, unless otherwise specified)


Fig. 1 - Forward Current vs. Ambient Temperature

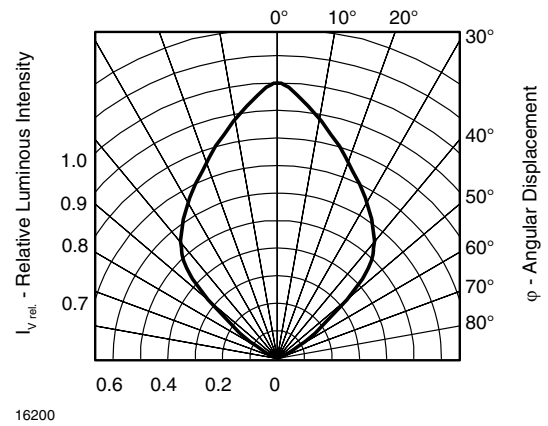


Fig. 3 - Relative Luminous Intensity vs. Angular Displacement

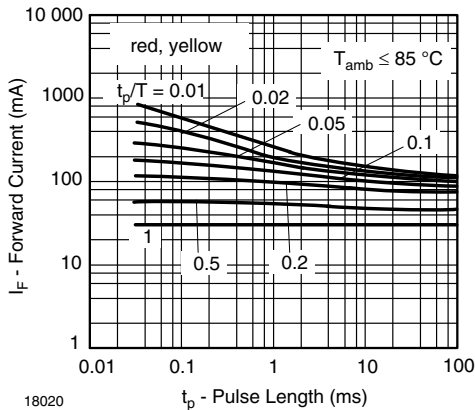


Fig. 2 - Forward Current vs. Pulse Length

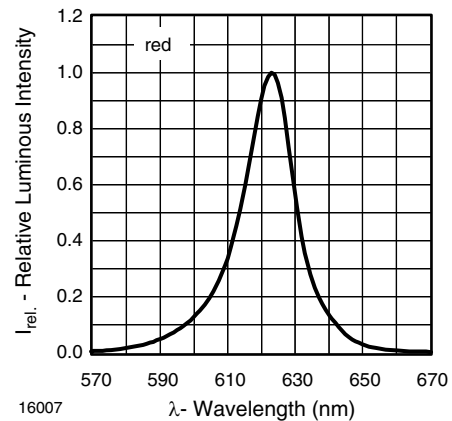


Fig. 4 - Relative Intensity vs. Wavelength

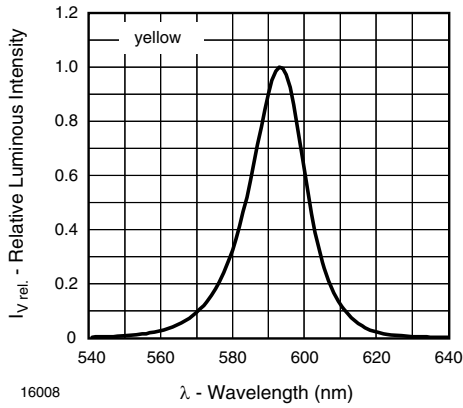


Fig. 5 - Relative Intensity vs. Wavelength

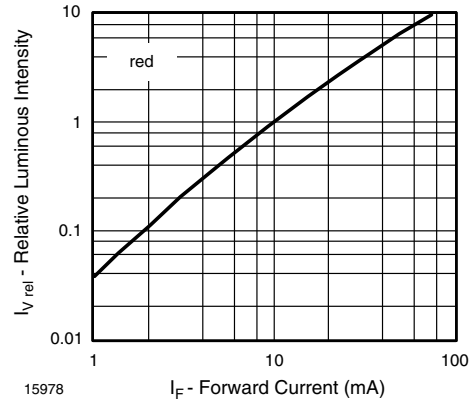


Fig. 8 - Relative Luminous Flux vs. Forward Current

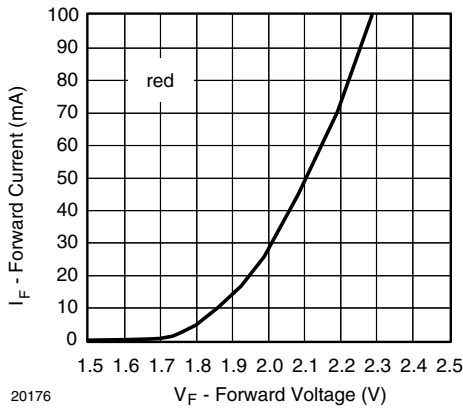


Fig. 6 - Forward Current vs. Forward Voltage

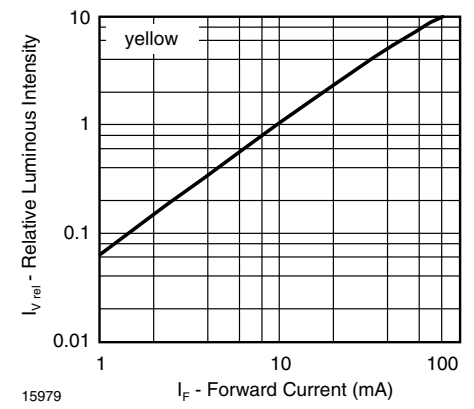


Fig. 9 - Relative Luminous Flux vs. Forward Current



Fig. 7 - Forward Current vs. Forward Voltage

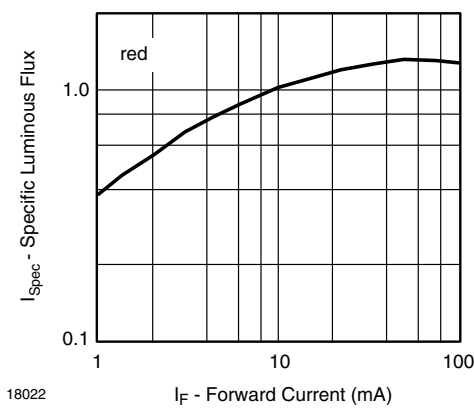


Fig. 10 - Specific Luminous Flux vs. Forward Current

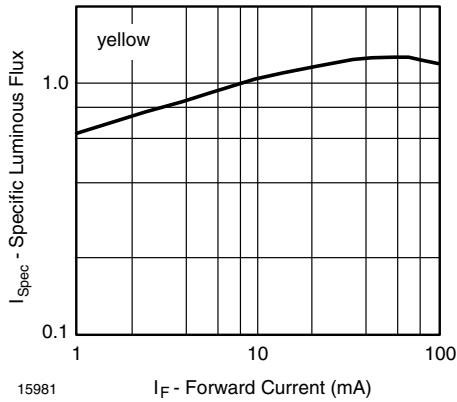


Fig. 11 - Specific Luminous Flux vs. Forward Current



Fig. 14 - Thermal Resistance Junction Ambient vs. Cathode Pads Size

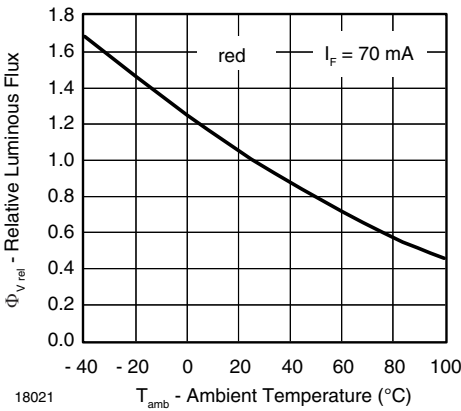


Fig. 12 - Relative Luminous Flux vs. Ambient Temperature

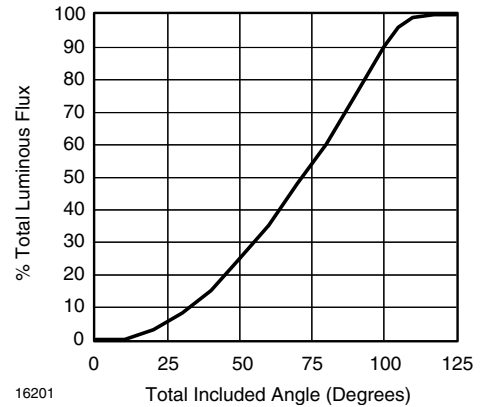


Fig. 15 - Percentage Total Luminous Flux vs. Total Included Angle for 90° Emission Angle

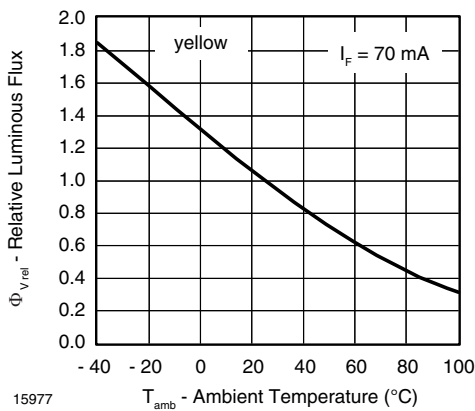
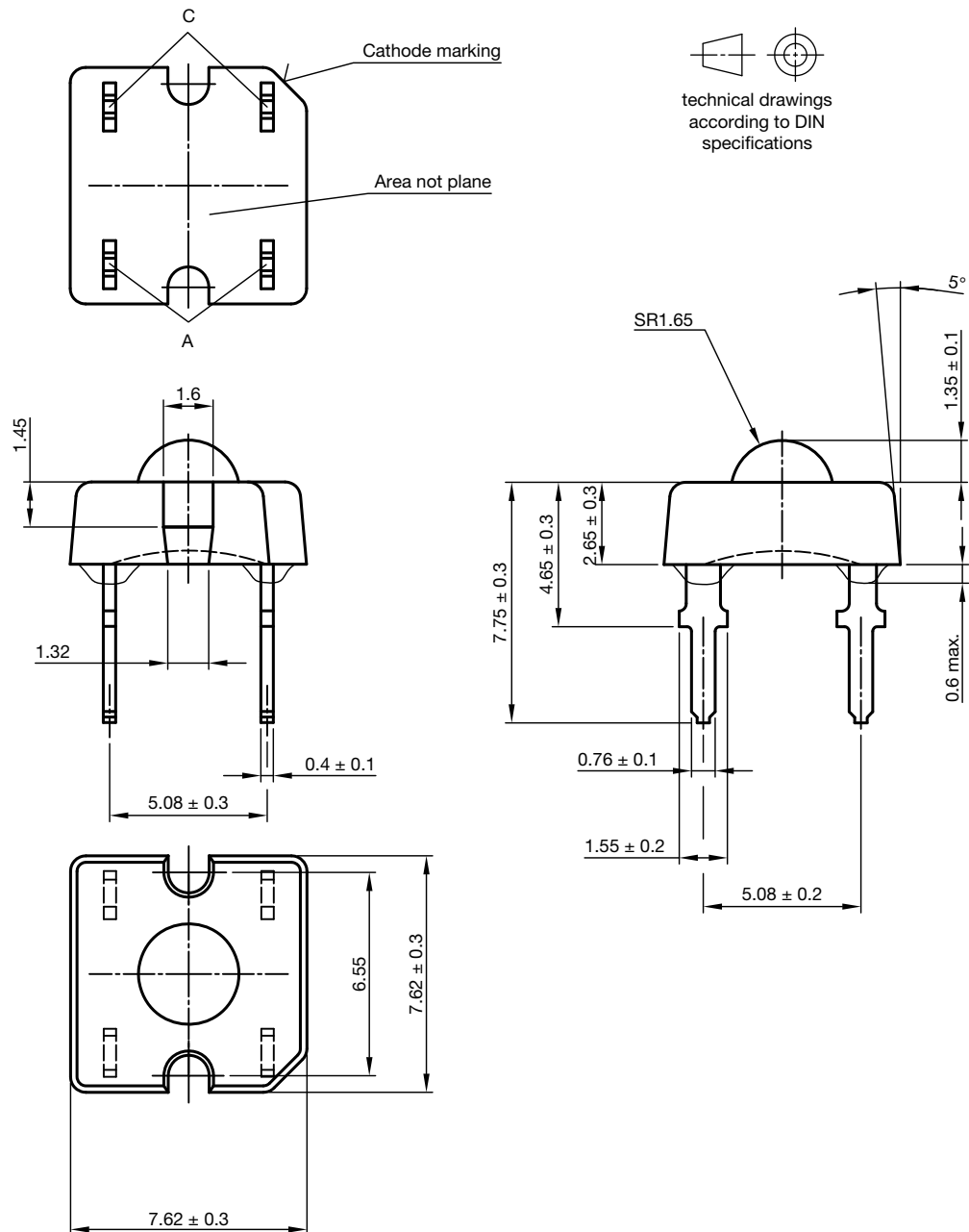


Fig. 13 - Relative Luminous Flux vs. Ambient Temperature



PACKAGE DIMENSIONS in millimeters



Drawing-No.: 6.544-5321.01-4

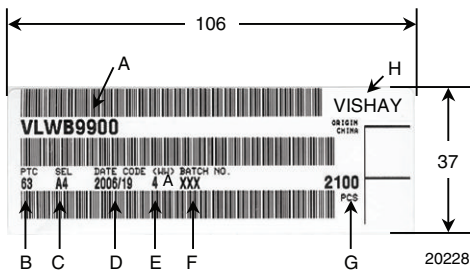
Issue: 5; 25.07.14



FAN FOLD BOX DIMENSIONS in millimeters

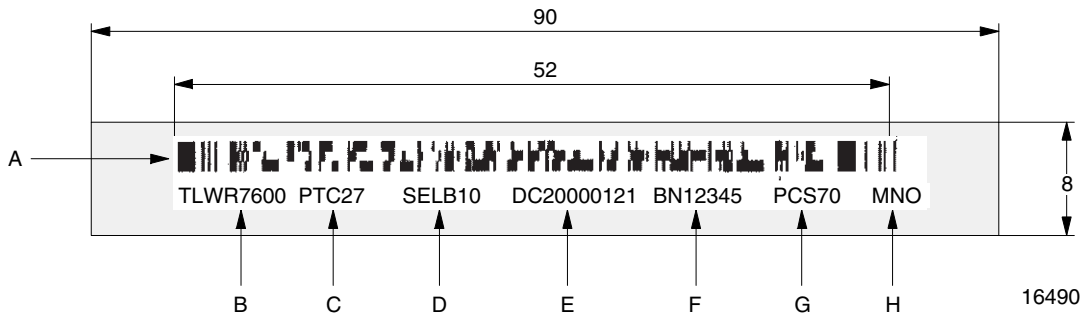


LABEL OF FAN FOLD BOX (example)



- A. Type of component
- B. Manufacturing plant
- C. SEL - selection code (bin):
e.g.: A = code for luminous intensity group
4 = code for color group
- D. Date code year / week
- E. Day code (e.g. 4: Thursday, A: early shift)
- F. Batch: no.
- G. Total quantity
- H. Company code

EXAMPLE FOR TELUX TUBE LABEL DIMENSIONS in millimeters



- A. Bar code
- B. Type of component
- C. Manufacturing plant
- D. SEL - selection code (bin):
digit 1 - code for luminous flux group
digit 2 - code for dominant wavelength group
digit 3 - code for forward voltage group
- E. Date code
- F. Batch: no.
- G. Total quantity
- H. Company code

TUBE WITH BAR CODE LABEL DIMENSIONS in millimeters

"X"

90° gedreht / 90° turned



Wanddicke/wall thickness: 0.6±0.1
 Geradheit/Straightness 2
 Schnittwinkel/cut 90° ±1°

Geprüft nach/approved to: LV 5145

Bestücken mit 1 Stopper / equip with 1 stopper



Druck / Printing for tubes
 1.400-5548.0-3 Version 1

Siebdruck von dieser Seite lesbar
 Screen printing readable from this side

Drawing-No.: 9.700-5223.0-4
 Rev. 2; Date: 23.08.99
 20438

Drawing Proportions not Scaled



Disclaimer

ALL PRODUCT, PRODUCT SPECIFICATIONS AND DATA ARE SUBJECT TO CHANGE WITHOUT NOTICE TO IMPROVE RELIABILITY, FUNCTION OR DESIGN OR OTHERWISE.

Vishay Intertechnology, Inc., its affiliates, agents, and employees, and all persons acting on its or their behalf (collectively, "Vishay"), disclaim any and all liability for any errors, inaccuracies or incompleteness contained in any datasheet or in any other disclosure relating to any product.

Vishay makes no warranty, representation or guarantee regarding the suitability of the products for any particular purpose or the continuing production of any product. To the maximum extent permitted by applicable law, Vishay disclaims (i) any and all liability arising out of the application or use of any product, (ii) any and all liability, including without limitation special, consequential or incidental damages, and (iii) any and all implied warranties, including warranties of fitness for particular purpose, non-infringement and merchantability.

Statements regarding the suitability of products for certain types of applications are based on Vishay's knowledge of typical requirements that are often placed on Vishay products in generic applications. Such statements are not binding statements about the suitability of products for a particular application. It is the customer's responsibility to validate that a particular product with the properties described in the product specification is suitable for use in a particular application. Parameters provided in datasheets and / or specifications may vary in different applications and performance may vary over time. All operating parameters, including typical parameters, must be validated for each customer application by the customer's technical experts. Product specifications do not expand or otherwise modify Vishay's terms and conditions of purchase, including but not limited to the warranty expressed therein.

Except as expressly indicated in writing, Vishay products are not designed for use in medical, life-saving, or life-sustaining applications or for any other application in which the failure of the Vishay product could result in personal injury or death. Customers using or selling Vishay products not expressly indicated for use in such applications do so at their own risk. Please contact authorized Vishay personnel to obtain written terms and conditions regarding products designed for such applications.

No license, express or implied, by estoppel or otherwise, to any intellectual property rights is granted by this document or by any conduct of Vishay. Product names and markings noted herein may be trademarks of their respective owners.

X-ON Electronics

Largest Supplier of Electrical and Electronic Components

Click to view similar products for [Standard LEDs - Through Hole category](#):

Click to view products by [Vishay manufacturer](#):

Other Similar products are found below :

[LTL-10254W](#) [LTL-1214A](#) [LTL-3251A](#) [LTL-4262N](#) [LTL-433P](#) [LTL-5234](#) [LTL87HTBK](#) [LTL-87HD4B](#) [HLMP-EL30-PS0DD](#)
[1L0532V23G0TD001](#) [NSPW500CS](#) [NTE30036](#) [NTE30044](#) [NTE30059](#) [NTE3020](#) [LD CQDP-1U3U-W5-1-K](#) [LO566UHR3-70G-A3](#)
[LP379PPG1C0G0300001](#) [SLX-LX3044GD](#) [SLX-LX3044ID](#) [SLX-LX3044YD](#) [1.90690.3330000](#) [SSS-LX4673ID-410B](#) [1L0532Y24I0TD001](#)
[264-7SYGD/S530-E2](#) [HLMP1385](#) [LTL-10224W](#) [LTL-1224A](#) [LTL-1234A](#) [LTL-2251AT](#) [LTL-307YE-012](#) [LTL-403HR](#) [LTL-4222](#) [LU7-E-](#)
[B](#) [4380H1](#) [TLHY44K1L2](#) [HLMP-3962-F0002](#) [HLMP-GG15-R0000](#) [323-2SURD/S530-A3](#) [L53SRC/E-Z](#) [L-7679C1ZGC](#) [4302T1-5V](#)
[4306D23](#) [4363D1/5](#) [WP1503SRC/J4](#) [WP153GDT](#) [WP153YDT](#) [WP1543SGC](#) [WP1543SURC](#) [WP53MGD](#)