

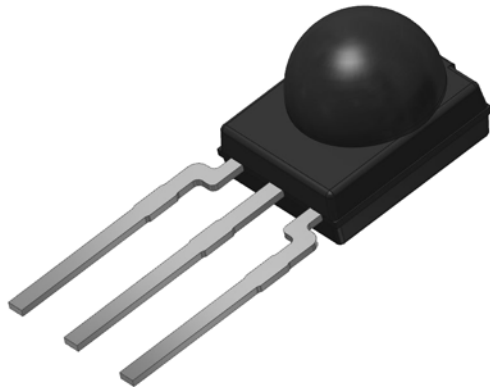

IR Receiver Modules for Remote Control Systems



MECHANICAL DATA

Pinning for TSOP33...:

1 = OUT, 2 = GND, 3 = V_S

FEATURES

- Very low supply current
- Photo detector and preamplifier in one package
- Internal filter for PCM frequency
- Supply voltage: 2.5 V to 5.5 V
- Improved immunity against ambient light
- Insensitive to supply voltage ripple and noise
- Compatible with wave or reflow soldering (see "P" version of Minimold option datasheets)



• Material categorization:
for definitions of compliance please see www.vishay.com/doc?99912

DESCRIPTION

The TSOP33... series are miniaturized IR receiver modules for infrared remote control systems. A PIN diode and a preamplifier are assembled on lead frame, the epoxy package contains an IR filter.

The demodulated output signal can be directly connected to a microprocessor for decoding.

The TSOP333.. series devices are optimized to suppress almost all spurious pulses from energy saving lamps like CFLs. AGC3 may also suppress some data signals if continuously transmitted.

The TSOP331.. series are provided primarily for compatibility with old AGC1 designs. New designs should prefer the TSOP333.. series containing the newer AGC3. The TSOP335.. series contain a very robust AGC5. This series should only be used for critically noisy environments.

These components have not been qualified according to automotive specifications.

PARTS TABLE				
AGC		LEGACY, FOR SHORT BURSTS (AGC1)	FOR SHORT BURSTS, NOISY ENVIRONMENTS (AGC3)	FOR SHORT BURSTS, VERY NOISY ENVIRONMENTS (AGC5)
Carrier frequency	30 kHz	TSOP33130	TSOP33330	TSOP33530
	33 kHz	TSOP33133	TSOP33333	TSOP33533
	36 kHz	TSOP33136	TSOP33336 (1)(2)	TSOP33536
	38 kHz	TSOP33138	TSOP33338 (3)(4)(5)(6)	TSOP33538
	40 kHz	TSOP33140	TSOP33340	TSOP33540
	56 kHz	TSOP33156	TSOP33356	TSOP33556
Package	Minimold			
Pinning	1 = OUT, 2 = GND, 3 = V _S			
Dimensions (mm)	5.4 W x 6.35 H x 4.9 D			
Mounting	Leaded			
Application	Remote control			
Best remote control code	(1) MCIR (2) RCMM (3) Mitsubishi (4) RECS-80 Code (5) r-map (6) XMP-1, XMP-2			

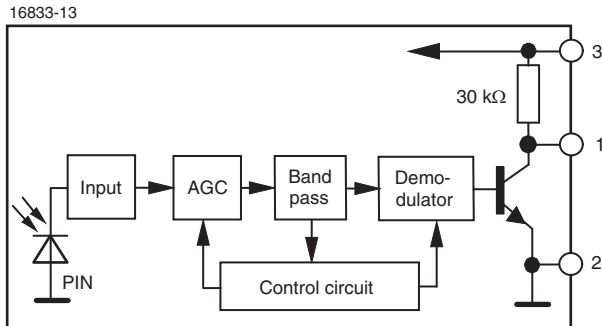
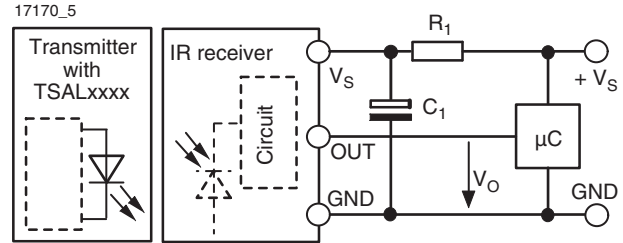
BLOCK DIAGRAM

APPLICATION CIRCUIT

R_1 and C_1 are recommended for protection against EOS. Components should be in the range of $33 \Omega < R_1 < 1 \text{ k}\Omega$, $C_1 > 0.1 \mu\text{F}$.

ABSOLUTE MAXIMUM RATINGS

PARAMETER	TEST CONDITION	SYMBOL	VALUE	UNIT
Supply voltage		V_S	-0.3 to +6	V
Supply current		I_S	3	mA
Output voltage		V_O	-0.3 to $(V_S + 0.3)$	V
Output current		I_O	5	mA
Junction temperature		T_j	100	°C
Storage temperature range		T_{stg}	-25 to +85	°C
Operating temperature range		T_{amb}	-25 to +85	°C
Power consumption	$T_{\text{amb}} \leq 85 \text{ }^\circ\text{C}$	P_{tot}	10	mW
Soldering temperature	$t \leq 10 \text{ s}$, 1 mm from case	T_{sd}	260	°C

Note

- Stresses beyond those listed under "Absolute Maximum Ratings" may cause permanent damage to the device. This is a stress rating only and functional operation of the device at these or any other conditions beyond those indicated in the operational sections of this specification is not implied. Exposure to absolute maximum rating conditions for extended periods may affect the device reliability.

ELECTRICAL AND OPTICAL CHARACTERISTICS ($T_{\text{amb}} = 25 \text{ }^\circ\text{C}$, unless otherwise specified)

PARAMETER	TEST CONDITION	SYMBOL	MIN.	TYP.	MAX.	UNIT
Supply current	$E_v = 0$, $V_S = 3.3 \text{ V}$	I_{SD}	0.27	0.35	0.45	mA
	$E_v = 40 \text{ klx}$, sunlight	I_{SH}	-	0.45	-	mA
Supply voltage		V_S	2.5	-	5.5	V
Transmission distance	$E_v = 0$, test signal see Fig. 1, IR diode TSAL6200, $I_F = 150 \text{ mA}$	d	-	45	-	m
Output voltage low	$I_{\text{OSL}} = 0.5 \text{ mA}$, $E_e = 0.7 \text{ mW/m}^2$, test signal see Fig. 1	V_{OSL}	-	-	100	mV
Minimum irradiance	Pulse width tolerance: $t_{\text{pi}} - 5/f_0 < t_{\text{po}} < t_{\text{pi}} + 6/f_0$, test signal see Fig. 1	$E_e \text{ min.}$	-	0.08	0.15	mW/m^2
Maximum irradiance	$t_{\text{pi}} - 5/f_0 < t_{\text{po}} < t_{\text{pi}} + 6/f_0$, test signal see Fig. 1	$E_e \text{ max.}$	30	-	-	W/m^2
Directivity	Angle of half transmission distance	$\phi_{1/2}$	-	± 45	-	deg

TYPICAL CHARACTERISTICS ($T_{amb} = 25\text{ }^{\circ}\text{C}$, unless otherwise specified)

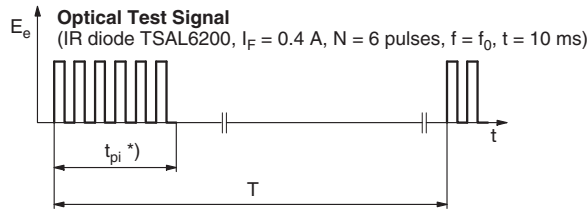

*) $t_{pi} \geq 6/f_0$ is recommended for optimal function

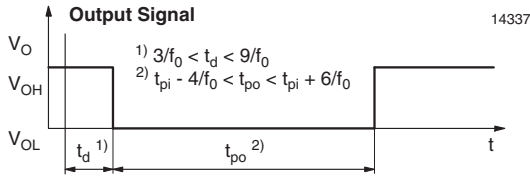

Fig. 1 - Output Active Low

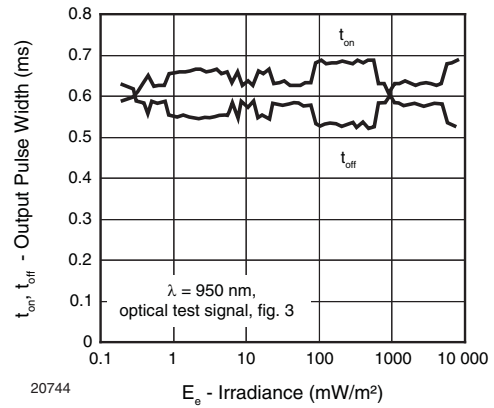

Fig. 4 - Output Pulse Diagram

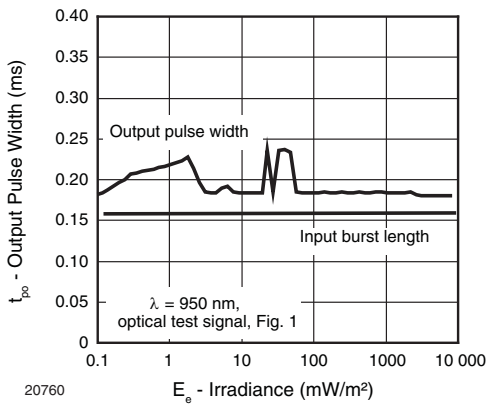

Fig. 2 - Pulse Length and Sensitivity in Dark Ambient

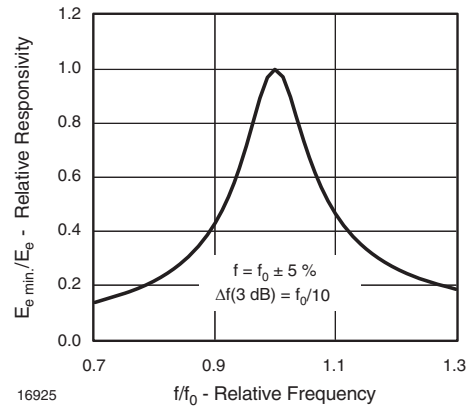

Fig. 5 - Frequency Dependence of Responsivity

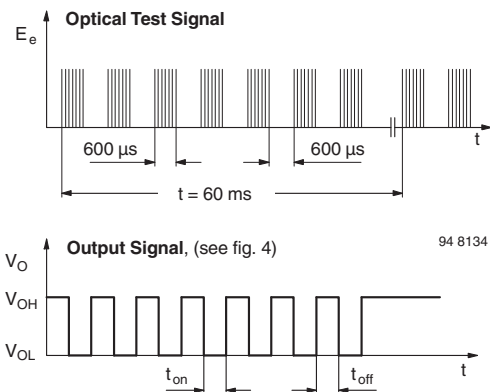

Fig. 3 - Output Function

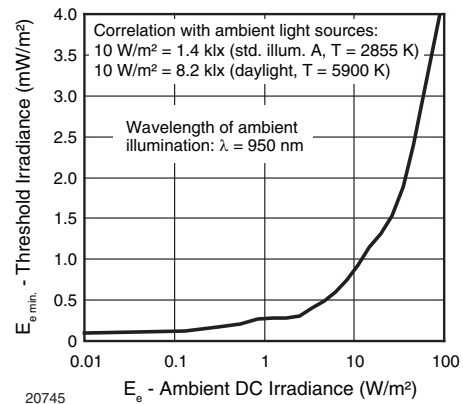

Fig. 6 - Sensitivity in Bright Ambient

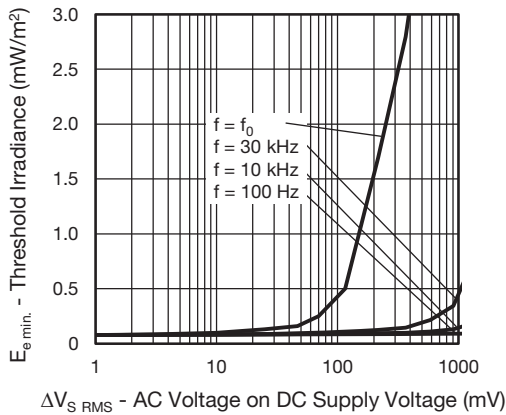

Fig. 7 - Sensitivity vs. Supply Voltage Disturbances

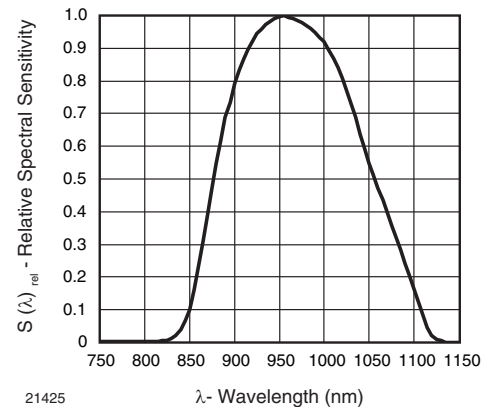

Fig. 10 - Relative Spectral Sensitivity vs. Wavelength

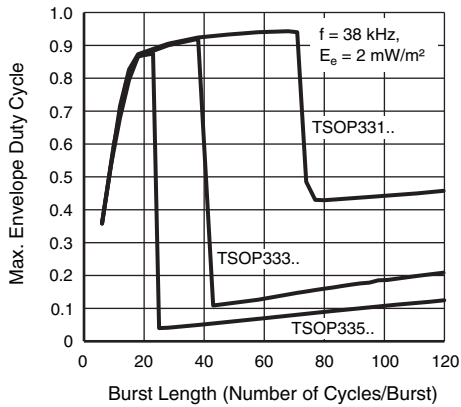

Fig. 8 - Max. Envelope Duty Cycle vs. Burst Length

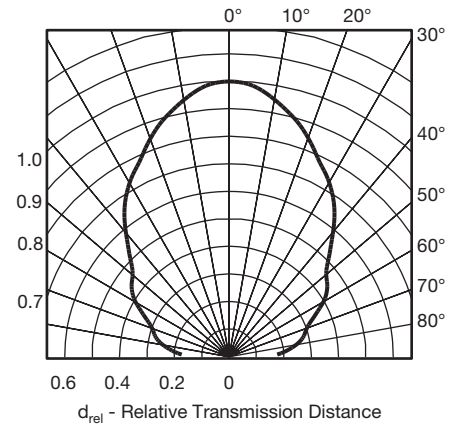

Fig. 11 - Horizontal Directivity

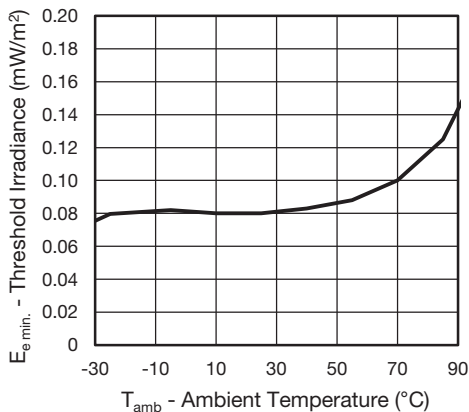

Fig. 9 - Sensitivity vs. Ambient Temperature

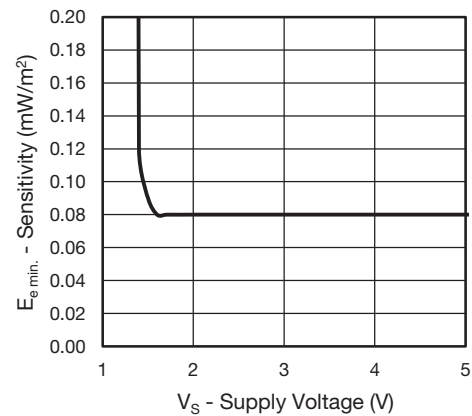

Fig. 12 - Sensitivity vs. Supply Voltage

SUITABLE DATA FORMAT

This series is designed to suppress spurious output pulses due to noise or disturbance signals. The devices can distinguish data signals from noise due to differences in frequency, burst length, and envelope duty cycle. The data signal should be close to the device's band-pass center frequency (e.g. 38 kHz) and fulfill the conditions in the table below.

When a data signal presented to the device in the presence of a disturbance, the sensitivity of the receiver is automatically reduced by the AGC to insure that no spurious pulses are present at the receiver's output. Some examples which are suppressed are:

- DC light (e.g. from tungsten bulbs sunlight)
- Continuous signals at any frequency
- Strongly or weakly modulated patterns from fluorescent lamps with electronic ballasts (see Fig. 13 or Fig. 14).

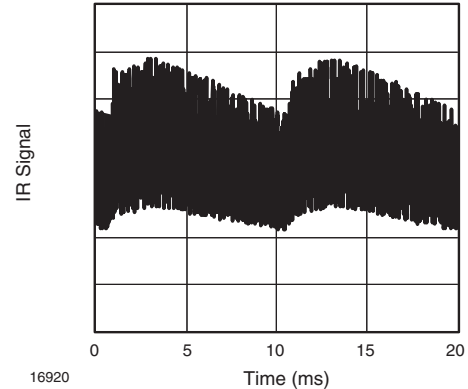

Fig. 13 - IR Disturbance from Fluorescent Lamp with Low Modulation

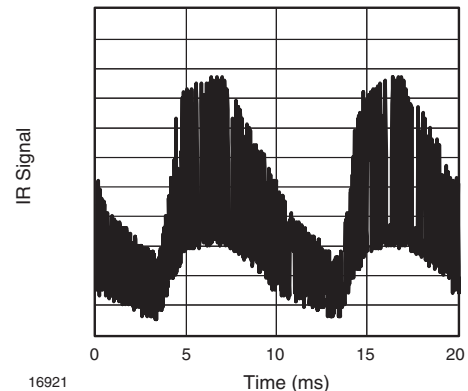

Fig. 14 - IR Disturbance from Fluorescent Lamp with High Modulation

	TSOP331..	TSOP333..	TSOP335..
Minimum burst length	6 cycles/burst	6 cycles/burst	6 cycles/burst
After each burst of length A gap time is required of	6 to 70 cycles ≥ 10 cycles	6 to 35 cycles ≥ 10 cycles	6 to 24 cycles ≥ 10 cycles
For bursts greater than a minimum gap time in the data stream is needed of	70 cycles > 1.2 x burst length	35 cycles > 6 x burst length	24 cycles > 25 ms
Maximum number of continuous short bursts/second	2000	2000	2000
MCIR code	Yes	Preferred	Yes
RCMM code	Yes	Preferred	Yes
XMP-1, XMP-2 code	Yes	Preferred	Yes
Suppression of interference from fluorescent lamps	Mild disturbance patterns are suppressed (example: signal pattern of Fig. 13)	Complex disturbance patterns are suppressed (example: signal pattern of Fig. 14)	Critical disturbance patterns are suppressed, e.g. highly dimmed LCDs

Note

- For data formats with long bursts (more than 10 carrier cycles) please see the datasheet for TSOP332.., TSOP334..



PACKAGE DIMENSIONS in millimeters

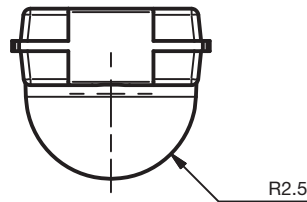
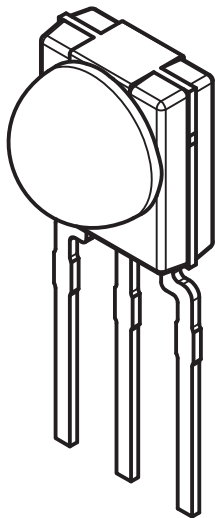
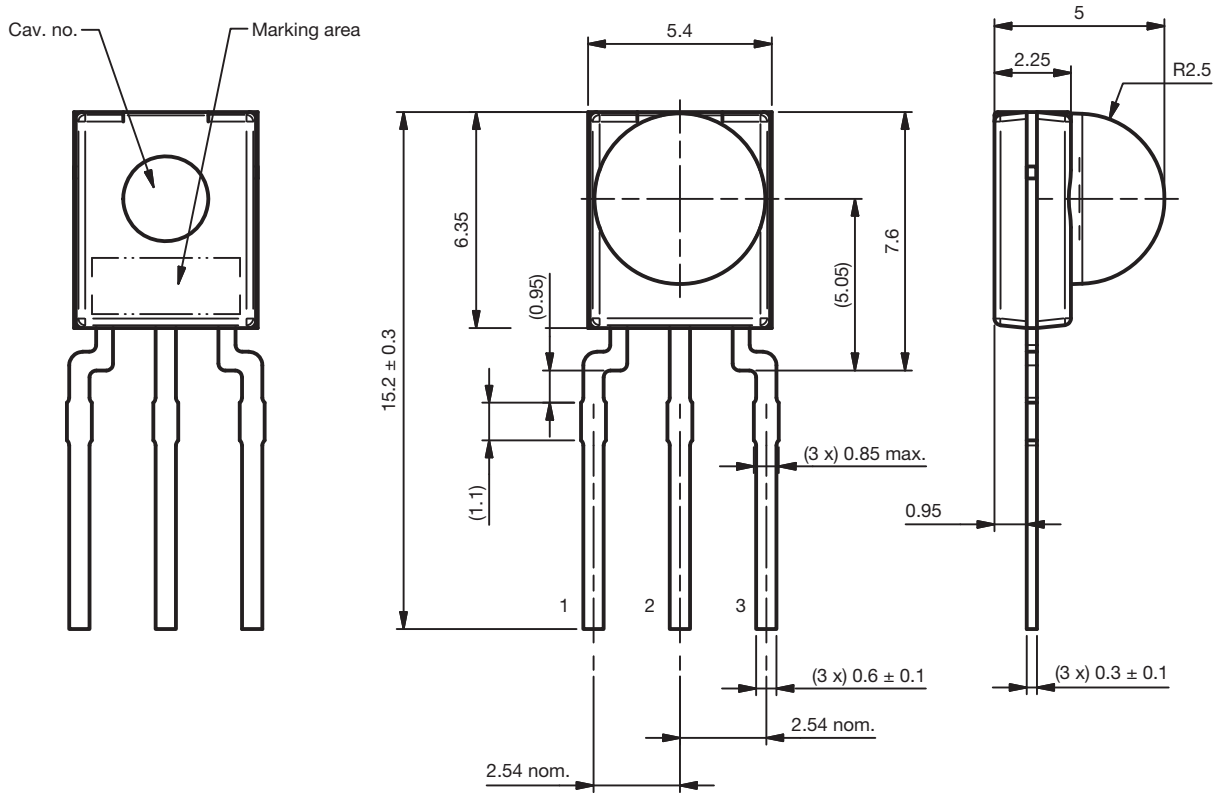

Not indicated tolerances ± 0.2

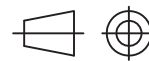

Technical drawings according to DIN specification.

Drawing no.: 6.550-5335.01-4
Issue: 1; 16.09.15



BULK PACKAGING

Standard shipping for minimold is in conductive plastic bags. The packing quantity is determined by weight and a maximum of 0.3 % of the components per carton may be missing.

ORDERING INFORMATION

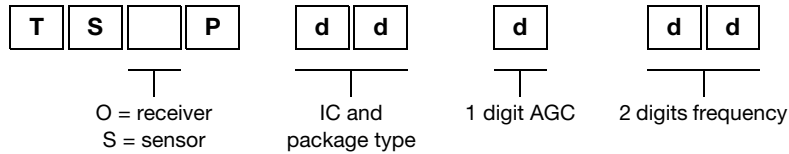

Note

- d = "digit", please consult the list of available series to create a valid part number.

Examples: **TSOP33338**

TSOP33356V11

TSOP33338SS1F

PACKAGING QUANTITY

- 300 pieces per bag (each bag is individually boxed).
- 6 bags per carton



Disclaimer

ALL PRODUCT, PRODUCT SPECIFICATIONS AND DATA ARE SUBJECT TO CHANGE WITHOUT NOTICE TO IMPROVE RELIABILITY, FUNCTION OR DESIGN OR OTHERWISE.

Vishay Intertechnology, Inc., its affiliates, agents, and employees, and all persons acting on its or their behalf (collectively, "Vishay"), disclaim any and all liability for any errors, inaccuracies or incompleteness contained in any datasheet or in any other disclosure relating to any product.

Vishay makes no warranty, representation or guarantee regarding the suitability of the products for any particular purpose or the continuing production of any product. To the maximum extent permitted by applicable law, Vishay disclaims (i) any and all liability arising out of the application or use of any product, (ii) any and all liability, including without limitation special, consequential or incidental damages, and (iii) any and all implied warranties, including warranties of fitness for particular purpose, non-infringement and merchantability.

Statements regarding the suitability of products for certain types of applications are based on Vishay's knowledge of typical requirements that are often placed on Vishay products in generic applications. Such statements are not binding statements about the suitability of products for a particular application. It is the customer's responsibility to validate that a particular product with the properties described in the product specification is suitable for use in a particular application. Parameters provided in datasheets and / or specifications may vary in different applications and performance may vary over time. All operating parameters, including typical parameters, must be validated for each customer application by the customer's technical experts. Product specifications do not expand or otherwise modify Vishay's terms and conditions of purchase, including but not limited to the warranty expressed therein.

Except as expressly indicated in writing, Vishay products are not designed for use in medical, life-saving, or life-sustaining applications or for any other application in which the failure of the Vishay product could result in personal injury or death. Customers using or selling Vishay products not expressly indicated for use in such applications do so at their own risk. Please contact authorized Vishay personnel to obtain written terms and conditions regarding products designed for such applications.

No license, express or implied, by estoppel or otherwise, to any intellectual property rights is granted by this document or by any conduct of Vishay. Product names and markings noted herein may be trademarks of their respective owners.

X-ON Electronics

Largest Supplier of Electrical and Electronic Components

Click to view similar products for [Infrared Receivers](#) category:

Click to view products by [Vishay](#) manufacturer:

Other Similar products are found below :

[TSOP38436](#) [TSOP6136TT](#) [TSOP2456](#) [TSOP31456](#) [TSOP38336](#) [TSOP6130TT](#) [TSOP57438ETT1](#) [TSOP6140TR](#) [TSOP53356](#) [TSOP53256](#)
[TSOP31136](#) [TSOP75338TR](#) [TSSP77038TT](#) [TSOP59438](#) [OSRB38C9AA](#) [TSOP75456TR](#) [TSSP4038SS1XB](#) [TSOP39438TR1](#) [TSOP6133TR](#)
[IS471FE](#) [OSRB38C9BA](#) [LT1328CMS8#PBF](#) [PB11CNT15WR](#) [IRM-3638M3F99-E80](#) [IRM-3638MF56](#) [IRM-3638C/TR1-11](#) [DY-PT4133B-](#)
[A2](#) [HL-304PT1C-T](#) [HL-503PT1C-T](#) [PT2424-6B](#) [PT334-6B-52](#) [R903V1-7C\(L\)](#) [GP1UD28YK](#) [GP1UM272RKVF](#) [GP1UM281QKVF](#)
[TSOP36438TT](#) [TSOP75340TT](#) [TSOP98238](#) [TSOP98456](#) [TSOP34338SS1VF](#) [TSDP34138](#) [TSDP34156](#) [TSDP34338](#) [TSDP34356](#)
[TSMP4138](#) [TSMP58000](#) [TSMP58138](#) [TSMP6000TT](#) [TSMP77000TR](#) [TSOP13236](#)