

IR Receiver Modules for Remote Control Systems

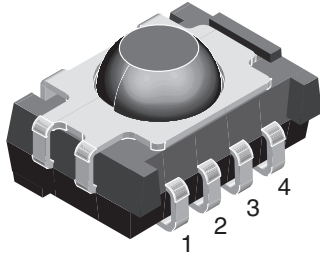

16797

MECHANICAL DATA

Pinning:

1 = GND, 2 = N.C., 3 = V_S , 4 = OUT

FEATURES

- Very low supply current
- Photo detector and preamplifier in one package
- Internal filter for PCM frequency
- Continuous data transmission possible
- Supply voltage: 2.5 V to 5.5 V
- Insensitive to supply voltage ripple and noise
- Compliant to RoHS Directive 2002/95/EC and in accordance to WEEE 2002/96/EC
- Taping available for topview and sideview assembly



DESCRIPTION

The TSOP351.., TSOP353.. and TSOP355.. series are miniaturized SMD IR receiver modules for infrared remote control systems. PIN diode and preamplifier are assembled on a lead frame, the epoxy package is designed as IR filter. The demodulated output signal can directly be decoded by a microprocessor. The TSOP351.. is compatible with all common IR remote control data formats. The TSOP353.. is optimized to better suppress spurious pulses from energy saving lamps. The TSOP355.. has an excellent noise suppression. It is immune to dimmed LCD backlighting and any fluorescent lamps. AGC3 and AGC5 may also suppress some data signals in case of continuous transmission. This component has not been qualified according to automotive specifications.

PARTS TABLE

CARRIER FREQUENCY	SHORT BURSTS AND HIGH DATA RATES (AGC1)	NOISY ENVIRONMENTS AND SHORT BURSTS (AGC3)	VERY NOISY ENVIRONMENTS AND SHORT BURSTS (AGC5)
30 kHz	TSOP35130	TSOP35330	TSOP35530
33 kHz	TSOP35133	TSOP35333	TSOP35533
36 kHz	TSOP35136	TSOP35336	TSOP35536
38 kHz	TSOP35138	TSOP35338	TSOP35538
40 kHz	TSOP35140	TSOP35340	TSOP35540
56 kHz	TSOP35156	TSOP35356	TSOP35556

BLOCK DIAGRAM

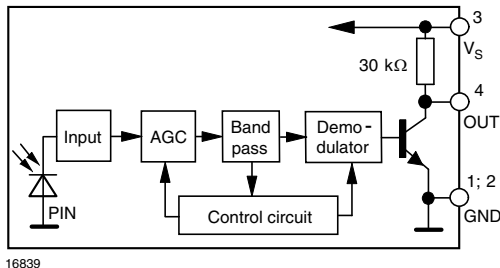

16839

APPLICATION CIRCUIT

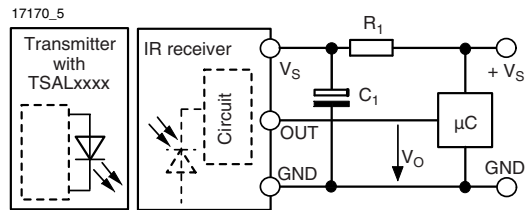

R_1 and C_1 are recommended for protection against EOS. Components should be in the range of $33 \Omega < R_1 < 1 \text{ k}\Omega$, $C_1 > 0.1 \mu\text{F}$.

** Please see document "Vishay Material Category Policy": www.vishay.com/doc?99902

ABSOLUTE MAXIMUM RATINGS				
PARAMETER	TEST CONDITION	SYMBOL	VALUE	UNIT
Supply voltage (pin 3)		V_S	- 0.3 to + 6	V
Supply current (pin 3)		I_S	3	mA
Output voltage (pin 4)		V_O	- 0.3 to ($V_S + 0.3$)	V
Output current (pin 4)		I_O	5	mA
Junction temperature		T_j	100	°C
Storage temperature range		T_{stg}	- 40 to + 100	°C
Operating temperature range		T_{amb}	- 30 to + 85	°C
Power consumption	$T_{amb} \leq 85$ °C	P_{tot}	10	mW

Note

- Stresses beyond those listed under “Absolute Maximum Ratings” may cause permanent damage to the device. This is a stress rating only and functional operation of the device at these or any other conditions beyond those indicated in the operational sections of this specification is not implied. Exposure to absolute maximum rating conditions for extended periods may affect the device reliability.

ELECTRICAL AND OPTICAL CHARACTERISTICS ($T_{amb} = 25$ °C, unless otherwise specified)						
PARAMETER	TEST CONDITION	SYMBOL	MIN.	TYP.	MAX.	UNIT
Supply current (pin 3)	$E_v = 0, V_S = 3.3$ V	I_{SD}	0.27	0.35	0.45	mA
	$E_v = 40$ klx, sunlight	I_{SH}		0.45		mA
Supply voltage		V_S	2.5		5.5	V
Transmission distance	$E_v = 0$, test signal see fig. 1, IR diode TSAL6200, $I_F = 250$ mA	d		45		m
Output voltage low (pin 4)	$I_{OSL} = 0.5$ mA, $E_e = 0.7$ mW/m ² , test signal see fig. 1	V_{OSL}			100	mV
Minimum irradiance	Pulse width tolerance: $t_{pi} - 5/f_0 < t_{po} < t_{pi} + 6/f_0$, test signal see fig. 1	E_e min.		0.15	0.35	mW/m ²
Maximum irradiance	$t_{pi} - 5/f_0 < t_{po} < t_{pi} + 6/f_0$, test signal see fig. 1	E_e max.	30			W/m ²
Directivity	Angle of half transmission distance	$\phi_{1/2}$		± 50		deg

TYPICAL CHARACTERISTICS ($T_{amb} = 25$ °C, unless otherwise specified)

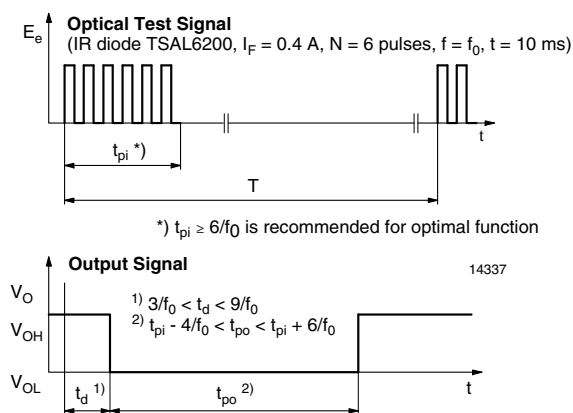

Fig. 1 - Output Function

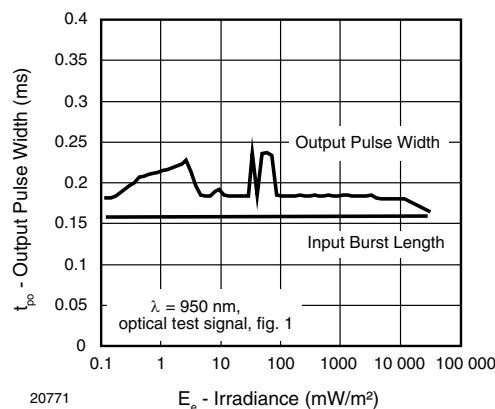

Fig. 2 - Pulse Length and Sensitivity in Dark Ambient



TSOP351.., TSOP353.., TSOP355..

IR Receiver Modules for Remote Control Systems Vishay Semiconductors

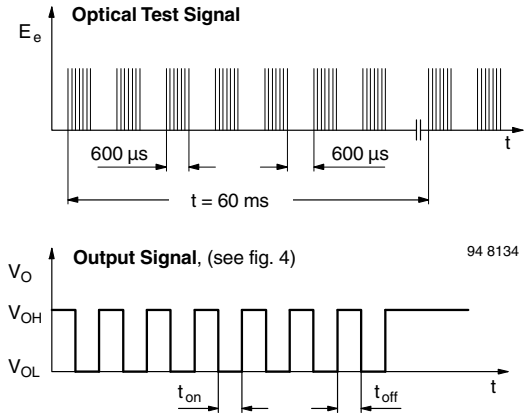

Fig. 3 - Output Function

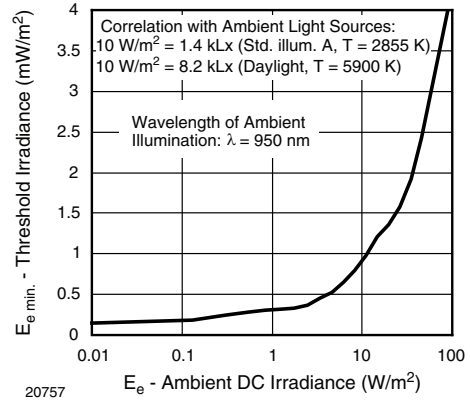

Fig. 6 - Sensitivity in Bright Ambient

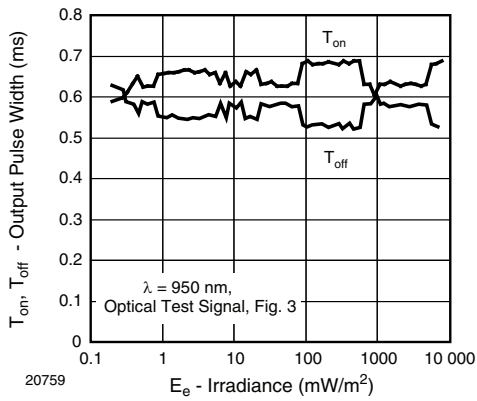

Fig. 4 - Output Pulse Diagram

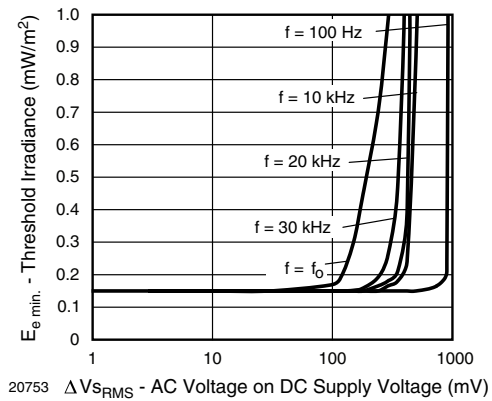

Fig. 7 - Sensitivity vs. Supply Voltage Disturbances

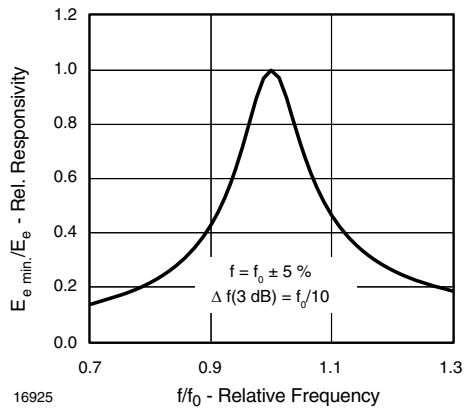

Fig. 5 - Frequency Dependence of Responsivity

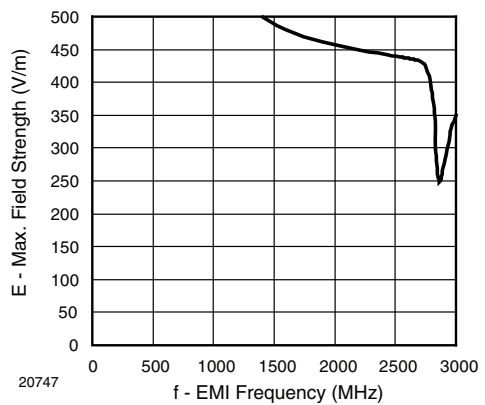

Fig. 8 - Sensitivity vs. Electric Field Disturbances

TSOP351..., TSOP353..., TSOP355..



Vishay Semiconductors IR Receiver Modules for Remote Control Systems

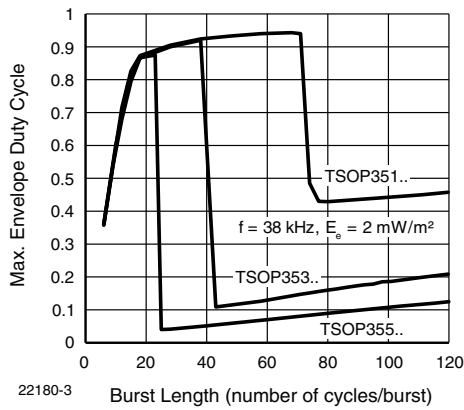

Fig. 9 - Max. Envelope Duty Cycle vs. Burstlength

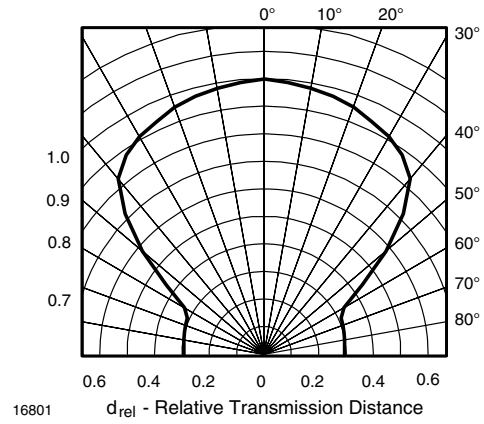

Fig. 12 - Directivity

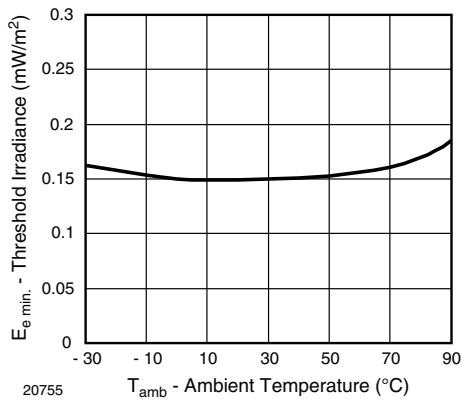

Fig. 10 - Sensitivity vs. Ambient Temperature

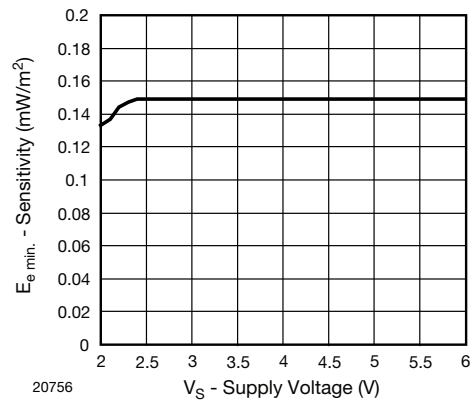

Fig. 13 - Sensitivity vs. Supply Voltage

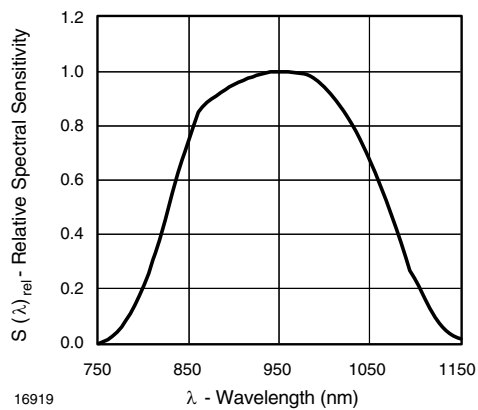

Fig. 11 - Relative Spectral Sensitivity vs. Wavelength

SUITABLE DATA FORMAT

The TSOP351.., TSOP353.. and TSOP355.. series is designed to suppress spurious output pulses due to noise or disturbance signals. Data and disturbance signals can be distinguished by the devices according to carrier frequency, burst length and envelope duty cycle. The data signal should be close to the band-pass center frequency (e.g. 38 kHz) and fulfill the conditions in the table below.

When a data signal is applied to the TSOP351.., TSOP353.. and TSOP355.. in the presence of a disturbance signal, the sensitivity of the receiver is reduced to insure that no spurious pulses are present at the output. Some examples of disturbance signals which are suppressed are:

- DC light (e.g. from tungsten bulb or sunlight)
- Continuous signals at any frequency
- Strongly or noise from fluorescent lamps with electronic ballasts

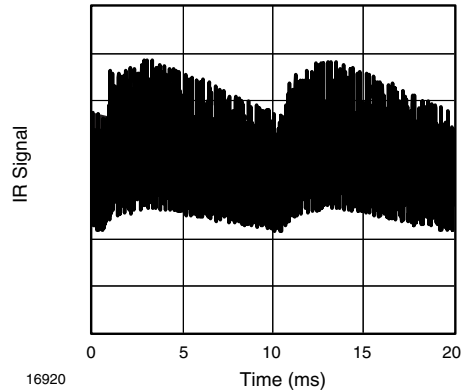

Fig. 14 - IR Signal from Fluorescent Lamp with Low Modulation

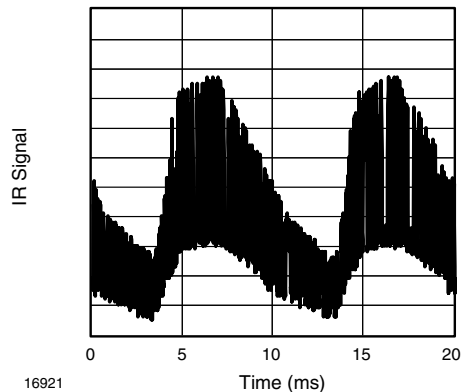

Fig. 15 - IR Signal from Fluorescent Lamp with High Modulation

	TSOP351..	TSOP353..	TSOP355..
Minimum burst length	6 cycles/burst	6 cycles/burst	6 cycles/burst
After each burst of length a minimum gap time is required of	6 to 70 cycles ≥ 10 cycles	6 to 35 cycles ≥ 10 cycles	6 to 24 cycles ≥ 10 cycles
For bursts greater than a minimum gap time in the data stream is needed of	70 cycles > 1.2 x burst length	35 cycles > 6 x burst length	24 cycles > 25 ms
Maximum number of continuous short bursts/second	2000	2000	2000
Recommended for NEC code	yes	yes	yes
Recommended for RC5/RC6 code	yes	yes	yes
Recommended for Sony code	yes	no	no
Recommended for RCMM code	yes	yes	yes
Recommended for r-step code	yes	yes	yes
Recommended for XMP code	yes	yes	yes
Suppression of interference from fluorescent lamps	Common disturbance signals are suppressed (example: signal pattern of fig. 14)	Even critical disturbance signals are suppressed (example: signal pattern of fig. 14 and fig. 15)	Even critical disturbance signals are suppressed (example: signal pattern of fig. 14 and fig. 15)

Note

- For data formats with long bursts (more than 10 carrier cycles) please see the datasheet for TSOP352.., TSOP354..

TSOP351.., TSOP353.., TSOP355..

Vishay Semiconductors IR Receiver Modules for Remote Control Systems



PACKAGE DIMENSIONS in millimeters

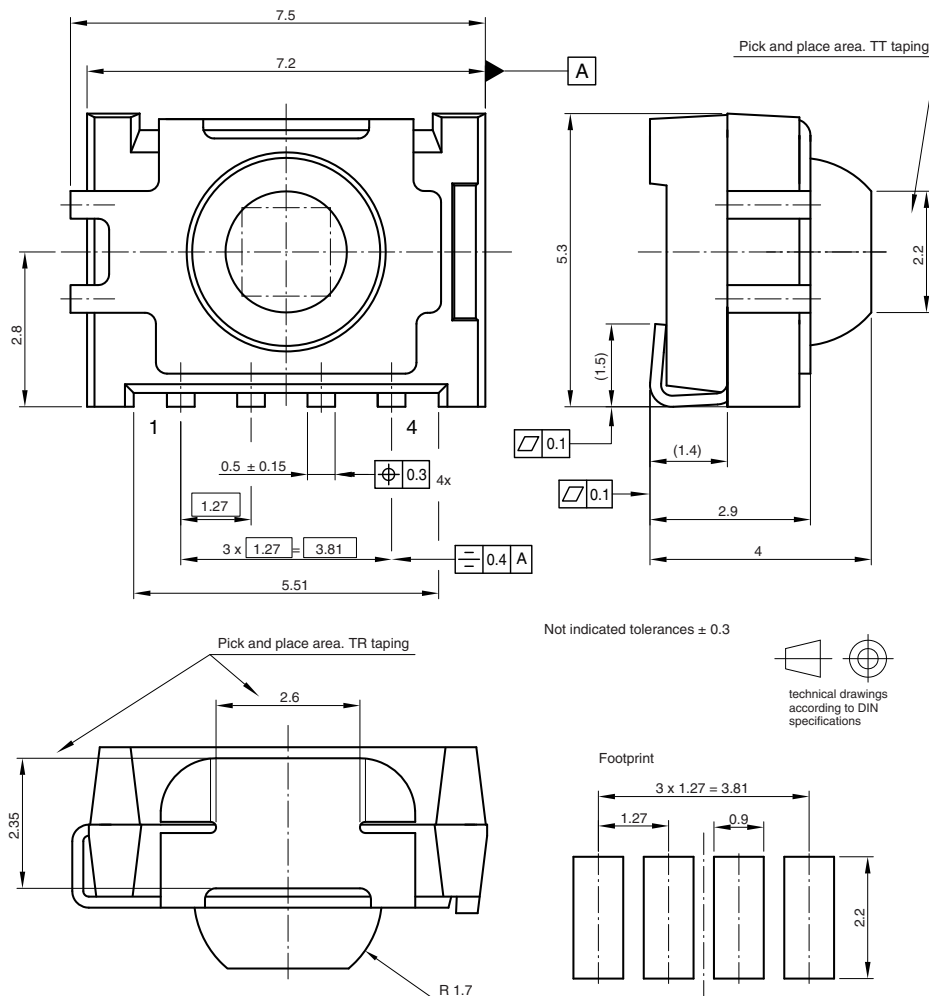

Drawing-No.: 6.544-5341.01-4
Issue: 8; 02.09.09
16776

ASSEMBLY INSTRUCTIONS

Reflow Soldering

- Reflow soldering must be done within 72 h while stored under a max. temperature of 30 °C, 60 % RH after opening the dry pack envelope
- Set the furnace temperatures for pre-heating and heating in accordance with the reflow temperature profile as shown in the diagram. Exercise extreme care to keep the maximum temperature below 260 °C. The temperature shown in the profile means the temperature at the device surface. Since there is a temperature difference between the component and the circuit board, it should be verified that the temperature of the device is accurately being measured
- Handling after reflow should be done only after the work surface has been cooled off

Manual Soldering

- Use a soldering iron of 25 W or less. Adjust the temperature of the soldering iron below 300 °C
- Finish soldering within 3 s
- Handle products only after the temperature has cooled off.



TSOP351.., TSOP353.., TSOP355..

IR Receiver Modules for Remote Control Systems Vishay Semiconductors

VISHAY LEAD (Pb)-FREE REFLOW SOLDER PROFILE

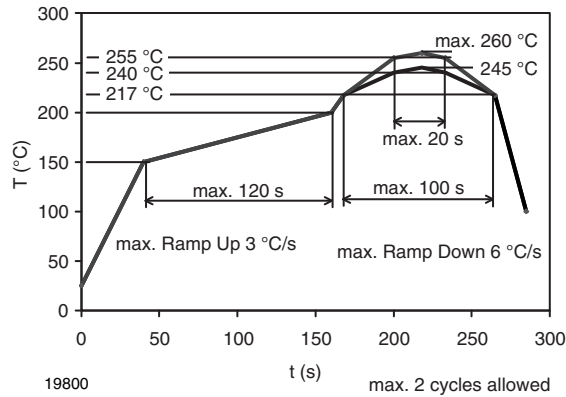

TAPING VERSION TSOP..TT DIMENSIONS in millimeters

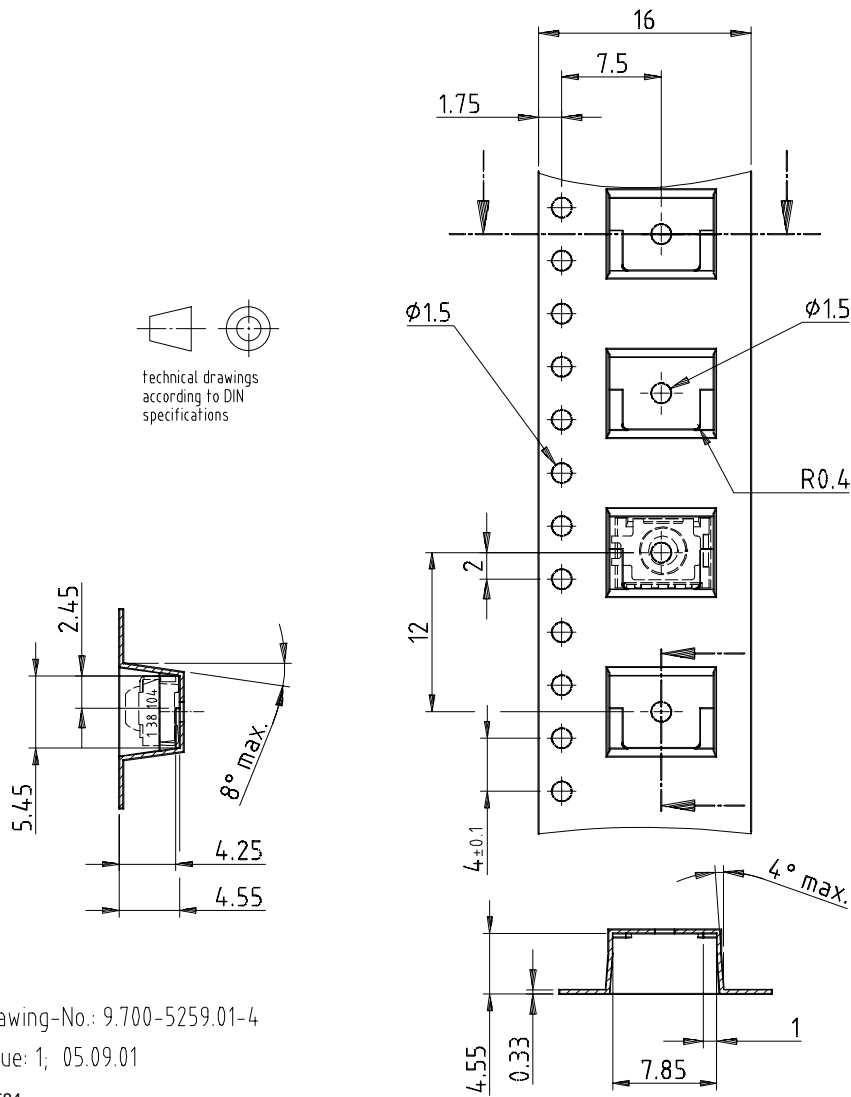

TSOP351.., TSOP353.., TSOP355..



Vishay Semiconductors IR Receiver Modules for Remote Control Systems

TAPING VERSION TSOP..TR DIMENSIONS in millimeters

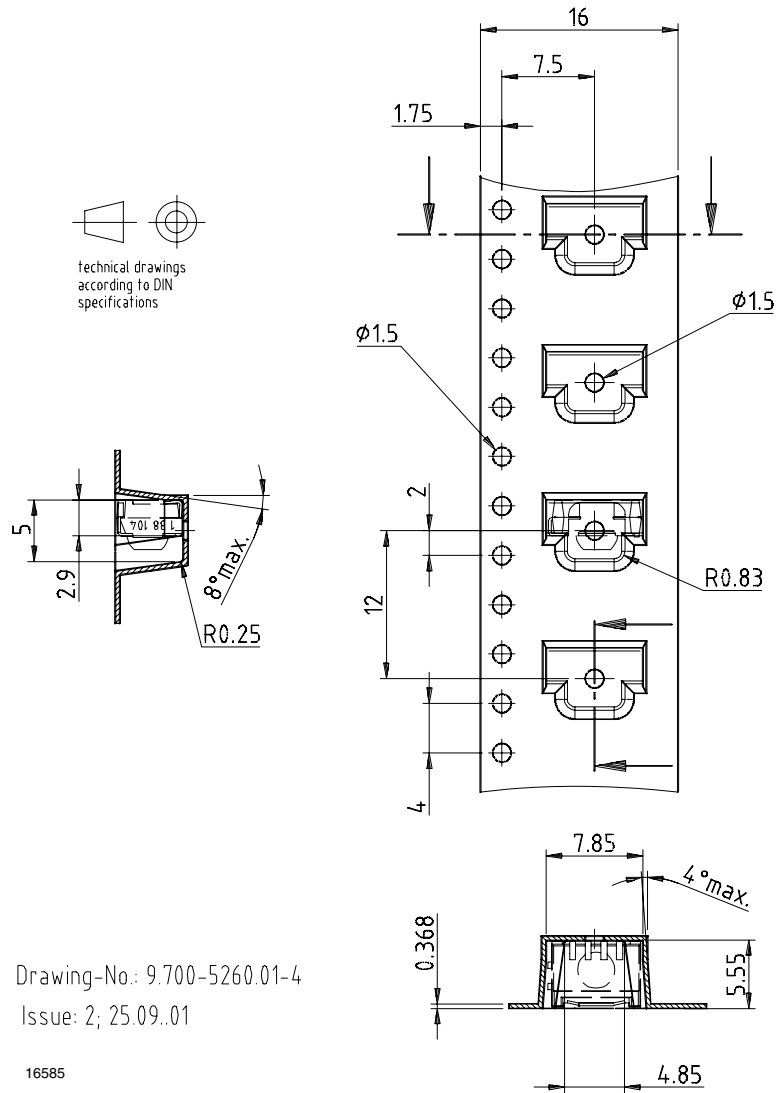



TSOP351.., TSOP353.., TSOP355..

IR Receiver Modules for Remote Control Systems Vishay Semiconductors

REEL DIMENSIONS in millimeters

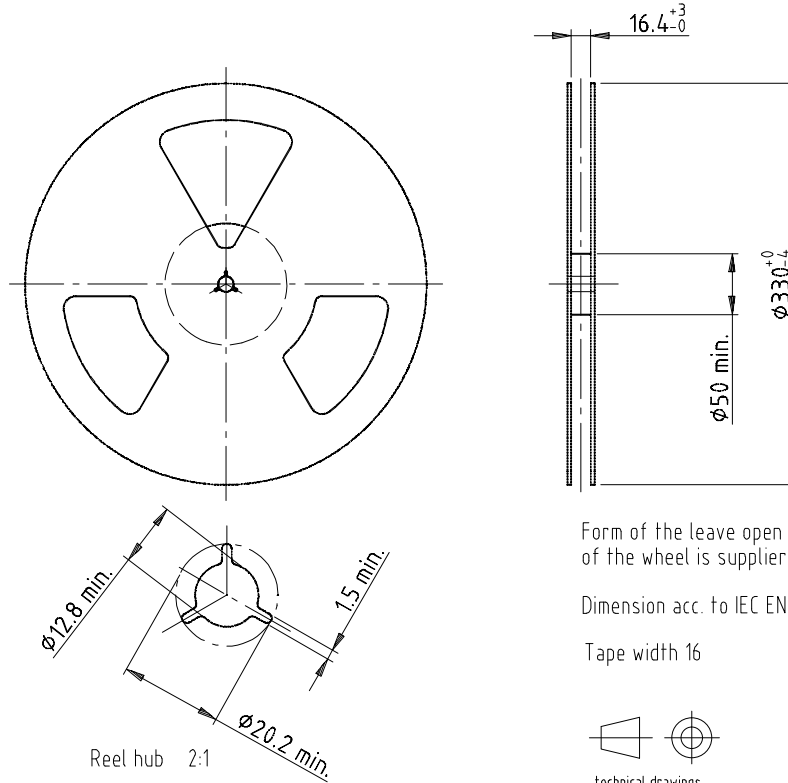

Drawing-No: 9.800-5052.V2-4
 Issue: 1; 07.05.02
 16734

Form of the leave open of the wheel is supplier specific.

Dimension acc. to IEC EN 60 286-3

Tape width 16

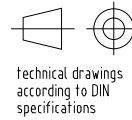

LEADER AND TRAILER DIMENSIONS in millimeters

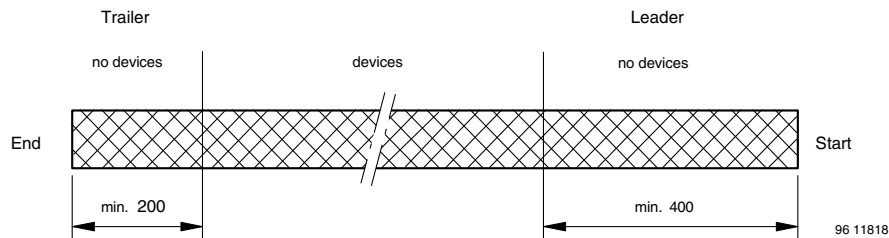

COVER TAPE PEEL STRENGTH

According to DIN EN 60286-3
 0.1 N to 1.3 N
 300 mm/min. ± 10 mm/min.
 165° to 180° peel angle

LABEL

Standard bar code labels for finished goods

The standard bar code labels are product labels and used for identification of goods. The finished goods are packed in final packing area. The standard packing units are labeled with standard bar code labels before transported as finished goods to warehouses. The labels are on each packing unit and contain Vishay Semiconductor GmbH specific data.

VISHAY SEMICONDUCTOR GmbH STANDARD BAR CODE PRODUCT LABEL (finished goods)		
PLAIN WRITTING	ABBREVIATION	LENGTH
Item-description	-	18
Item-number	INO	8
Selection-code	SEL	3
LOT-/serial-number	BATCH	10
Data-code	COD	3 (YWW)
Plant-code	PTC	2
Quantity	QTY	8
Accepted by	ACC	-
Packed by	PCK	-
Mixed code indicator	MIXED CODE	-
Origin	xxxxxxx+	Company logo
LONG BAR CODE TOP	TYPE	LENGTH
Item-number	N	8
Plant-code	N	2
Sequence-number	X	3
Quantity	N	8
Total length	-	21
SHORT BAR CODE BOTTOM	TYPE	LENGTH
Selection-code	X	3
Data-code	N	3
Batch-number	X	10
Filter	-	1
Total length	-	17

DRY PACKING

The reel is packed in an anti-humidity bag to protect the devices from absorbing moisture during transportation and storage.

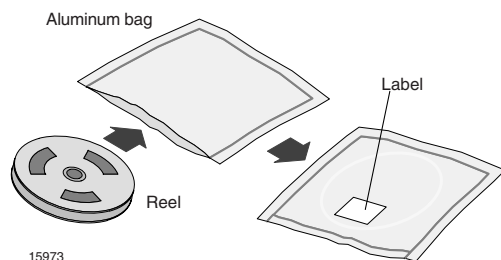

FINAL PACKING

The sealed reel is packed into a cardboard box. A secondary cardboard box is used for shipping purposes.

RECOMMENDED METHOD OF STORAGE

Dry box storage is recommended as soon as the aluminum bag has been opened to prevent moisture absorption. The following conditions should be observed, if dry boxes are not available:

- Storage temperature 10 °C to 30 °C
- Storage humidity ≤ 60 % RH max.

After more than 72 h under these conditions moisture content will be too high for reflow soldering.

In case of moisture absorption, the devices will recover to the former condition by drying under the following condition: 192 h at 40 °C + 5 °C/- 0 °C and < 5 % RH (dry air/nitrogen) or

96 h at 60 °C + 5 °C and < 5 % RH for all device containers or

24 h at 125 °C + 5 °C not suitable for reel or tubes.

An EIA JEDEC standard JSTD-020 level 4 label is included on all dry bags.



TSOP351.., TSOP353.., TSOP355..

IR Receiver Modules for Remote Control Systems Vishay Semiconductors

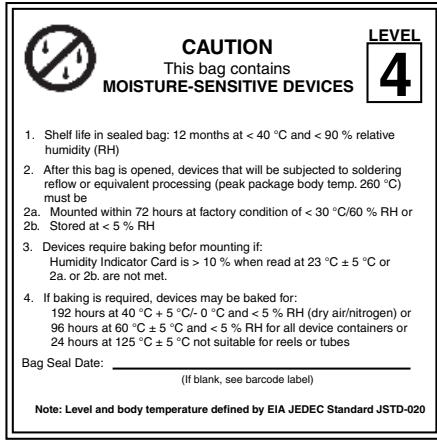

22522

EIA JEDEC standard JSTD-020 level 4 label is included on all dry bags

ESD PRECAUTION

Proper storage and handling procedures should be followed to prevent ESD damage to the devices especially when they are removed from the antistatic shielding bag. Electro-static sensitive devices warning labels are on the packaging.

VISHAY SEMICONDUCTORS STANDARD BAR CODE LABELS

The Vishay Semiconductors standard bar code labels are printed at final packing areas. The labels are on each packing unit and contain Vishay Semiconductors specific data.



16962



Disclaimer

ALL PRODUCT, PRODUCT SPECIFICATIONS AND DATA ARE SUBJECT TO CHANGE WITHOUT NOTICE TO IMPROVE RELIABILITY, FUNCTION OR DESIGN OR OTHERWISE.

Vishay Intertechnology, Inc., its affiliates, agents, and employees, and all persons acting on its or their behalf (collectively, "Vishay"), disclaim any and all liability for any errors, inaccuracies or incompleteness contained in any datasheet or in any other disclosure relating to any product.

Vishay makes no warranty, representation or guarantee regarding the suitability of the products for any particular purpose or the continuing production of any product. To the maximum extent permitted by applicable law, Vishay disclaims (i) any and all liability arising out of the application or use of any product, (ii) any and all liability, including without limitation special, consequential or incidental damages, and (iii) any and all implied warranties, including warranties of fitness for particular purpose, non-infringement and merchantability.

Statements regarding the suitability of products for certain types of applications are based on Vishay's knowledge of typical requirements that are often placed on Vishay products in generic applications. Such statements are not binding statements about the suitability of products for a particular application. It is the customer's responsibility to validate that a particular product with the properties described in the product specification is suitable for use in a particular application. Parameters provided in datasheets and/or specifications may vary in different applications and performance may vary over time. All operating parameters, including typical parameters, must be validated for each customer application by the customer's technical experts. Product specifications do not expand or otherwise modify Vishay's terms and conditions of purchase, including but not limited to the warranty expressed therein.

Except as expressly indicated in writing, Vishay products are not designed for use in medical, life-saving, or life-sustaining applications or for any other application in which the failure of the Vishay product could result in personal injury or death. Customers using or selling Vishay products not expressly indicated for use in such applications do so at their own risk. Please contact authorized Vishay personnel to obtain written terms and conditions regarding products designed for such applications.

No license, express or implied, by estoppel or otherwise, to any intellectual property rights is granted by this document or by any conduct of Vishay. Product names and markings noted herein may be trademarks of their respective owners.

Material Category Policy

Vishay Intertechnology, Inc. hereby certifies that all its products that are identified as RoHS-Compliant fulfill the definitions and restrictions defined under Directive 2011/65/EU of The European Parliament and of the Council of June 8, 2011 on the restriction of the use of certain hazardous substances in electrical and electronic equipment (EEE) - recast, unless otherwise specified as non-compliant.

Please note that some Vishay documentation may still make reference to RoHS Directive 2002/95/EC. We confirm that all the products identified as being compliant to Directive 2002/95/EC conform to Directive 2011/65/EU.

Vishay Intertechnology, Inc. hereby certifies that all its products that are identified as Halogen-Free follow Halogen-Free requirements as per JEDEC JS709A standards. Please note that some Vishay documentation may still make reference to the IEC 61249-2-21 definition. We confirm that all the products identified as being compliant to IEC 61249-2-21 conform to JEDEC JS709A standards.

X-ON Electronics

Largest Supplier of Electrical and Electronic Components

Click to view similar products for [vishay](#) manufacturer:

Other Similar products are found below :

[M39006/22-0577H](#) [Y00892K49000BR13L](#) [VSKT250-16PBF](#) [M8340109M6801GGD03](#) [NTCALUG01A103F291L](#) [ITU1341SM3](#) [VS-MBRB1545CTPBF](#) [1KAB100E](#) [1KAB20E](#) [IH10EB600K12](#) [CP0005150R0JE1490](#) [562R5GAD47RR](#) [S472M69Z5UR84K0R](#)
[MKP1848C65090JY5L](#) [CRCW1210360RFKEA](#) [VSMF4720-GS08](#) [TSOP34438SS1V](#) [CRCW04024021FRT7](#) [001789X](#) [LTO050FR0500JTE3](#)
[CRCW08054K00FKTA](#) [LVR10R0200FE03](#) [CRCW12063K30FKEAHP](#) [009923A](#) [CRCW2010331JR02](#) [CRCW25128K06FKEG](#)
[CS6600552K000B8768](#) [CSC07A0110K0GPA](#) [M34C156K100BZSS](#) [M39003/01-2289](#) [M39003/01-2784](#) [M39006/25-0133](#) [M39006/25-0228](#)
[M64W101KB40](#) [M64Z501KB40](#) [CW001R5000JS73](#) [CW0055R000JE12](#) [CW0056K800JB12](#) [CW0106K000JE73](#) [672D826H075EK5C](#)
[CWR06JC105KC](#) [CWR06NC475JC](#) [MAL219699001E3](#) [MCRL007035R00JHB00](#) [GBU4K-E3/51](#) [GBU8M-E3/51](#) [GF1A-E3/67A](#)
[PTF56100K00QYEK](#) [PTN0805H1502BBTR1K](#) [RCWL1210R130JNEA](#)