

Dual Common-Cathode Ultrafast Recovery Rectifier

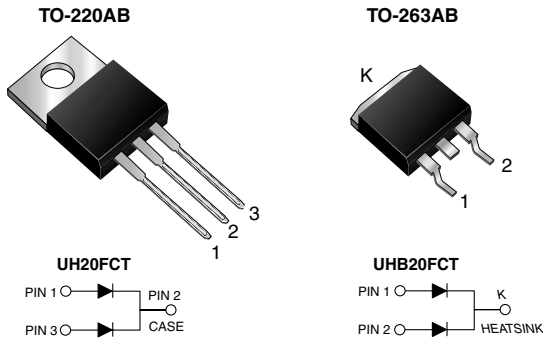

FEATURES

- Oxide planar chip junction
- Ultrafast recovery times
- Soft recovery characteristics
- Low switching losses, high efficiency
- High forward surge capability
- Meets MSL level 1, per J-STD-020C, LF max peak of 245 °C (for TO-263AB package)
- Solder Dip 260 °C, 40 seconds (for TO-220AB package)
- Component in accordance to RoHS 2002/95/EC and WEEE 2002/96/EC



TYPICAL APPLICATIONS

For use in high frequency power factor correctors, switching mode power supplies, free-wheeling diodes and secondary dc-to-dc rectification application.

MECHANICAL DATA

Case: TO-220AB & TO-263AB

Epoxy meets UL 94V-0 flammability rating

Terminals: Matte tin plated leads, solderable per J-STD-002B and JESD22-B102D

E3 suffix for commercial grade

Polarity: As marked

Mounting Torque: 10 in-lbs maximum

MAJOR RATINGS AND CHARACTERISTICS

$I_{F(AV)}$	10 A x 2
V_{RRM}	300 V
I_{FSM}	180 A
t_{rr}	25 ns
V_F	0.83 V
$T_j \text{ max}$	175 °C

MAXIMUM RATINGS ($T_A = 25\text{ °C}$ unless otherwise noted)

PARAMETER	SYMBOL	UH20FCT	UHB20FCT	UNIT
Maximum repetitive peak reverse voltage	V_{RRM}	300		V
Maximum average forward rectified current (see Fig.1)	$I_{F(AV)}$	20	10	A
Peak forward surge current 8.3 ms single half sine-wave superimposed on rated load	I_{FSM}	180		A
Operating junction and storage temperature range	T_J, T_{STG}	- 55 to + 175		°C

ELECTRICAL CHARACTERISTICS ($T_A = 25\text{ °C}$ unless otherwise noted)

PARAMETER	TEST CONDITIONS	SYMBOL	TYP.	MAX.	UNIT
Maximum instantaneous forward voltage per diode ⁽¹⁾	at $I_F = 5.0\text{ A}, T_j = 25\text{ °C}$	V_F	0.96	-	V
	$I_F = 5.0\text{ A}, T_j = 125\text{ °C}$		0.77	-	
	at $I_F = 10\text{ A}, T_j = 25\text{ °C}$		1.0	1.2	
	$I_F = 10\text{ A}, T_j = 125\text{ °C}$		0.83	0.90	
Maximum reverse current per diode ⁽¹⁾	at $V_R = 300\text{ V}$	I_R	0.5	5	μA
	$T_j = 125\text{ °C}$		25	150	



ELECTRICAL CHARACTERISTICS ($T_A = 25\text{ }^\circ\text{C}$ unless otherwise noted)					
PARAMETER	TEST CONDITIONS	SYMBOL	TYP.	MAX.	UNIT
Maximum reverse recovery time	at $I_F = 0.5\text{ A}$, $I_R = 1.0\text{ A}$, $I_{rr} = 0.25\text{ A}$	t_{rr}	20	25	ns
Maximum reverse recovery time per diode	at $I_F = 1.0\text{ A}$, $di/dt = 50\text{ A}/\mu\text{s}$, $V_R = 30\text{ V}$, $I_{rr} = 0.1 I_{RM}$	t_{rr}	28	35	ns
Typical softness factor (tb/ta)	at $I_F = 10\text{ A}$, $di/dt = 200\text{ A}/\mu\text{s}$, $V_R = 200\text{ V}$, $T_J = 125\text{ }^\circ\text{C}$ per diode	S	0.36	-	-
Typical reverse recovery current		I_{RM}	7.0	-	A
Typical stored charge		Q_{rr}	160	-	nC
Typical forward recovery time per diode	at $I_F = 10\text{ A}$, $di/dt = 80\text{ A}/\mu\text{s}$, $V_{FR} = 1.1 \times V_{Fmax}$	t_{fr}	150	-	ns

Note:

(1) Pulse test: 300 μs pulse width, 1 % duty cycle

THERMAL CHARACTERISTICS ($T_A = 25\text{ }^\circ\text{C}$ unless otherwise noted)				
PARAMETER	SYMBOL	UH20FCT	UHB20FCT	UNIT
Typical thermal resistance per diode	$R_{\theta JC}$	2.0	2.0	$^\circ\text{C}/\text{W}$

ORDERING INFORMATION					
PACKAGE	PREFERRED P/N	UNIT WEIGHT (g)	PACKAGE CODE	BASE QUANTITY	DELIVERY MODE
TO-220AB	UH20FCT-E3/4W	1.88	4W	50/Tube	Tube
TO-263AB	UHB20FCT-E3/4W	1.38	4W	50/Tube	Tube
TO-263AB	UHB20FCT-E3/8W	1.38	8W	800/Reel	Tape & Reel

RATINGS AND CHARACTERISTICS CURVES

($T_A = 25\text{ }^\circ\text{C}$ unless otherwise noted)

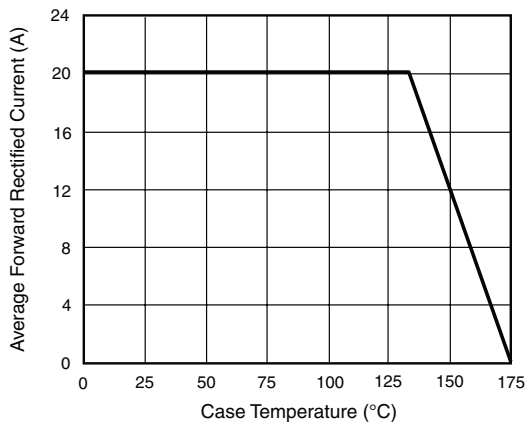

Figure 1. Maximum Forward Current Derating Curve

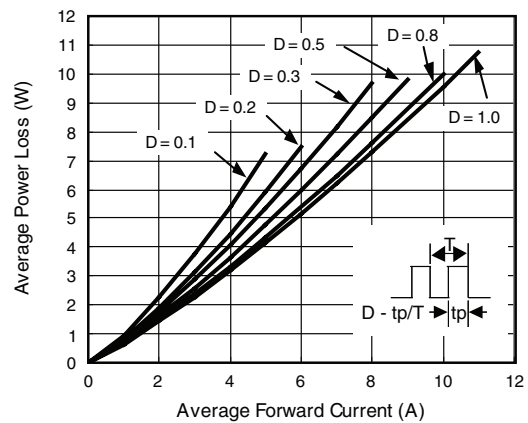

Figure 2. Forward Power Loss Characteristics Per Diode

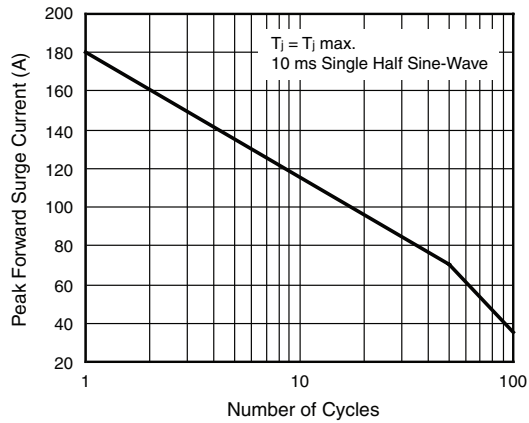

Figure 3. Maximum Non-Repetitive Peak Forward Surge Current Per Diode

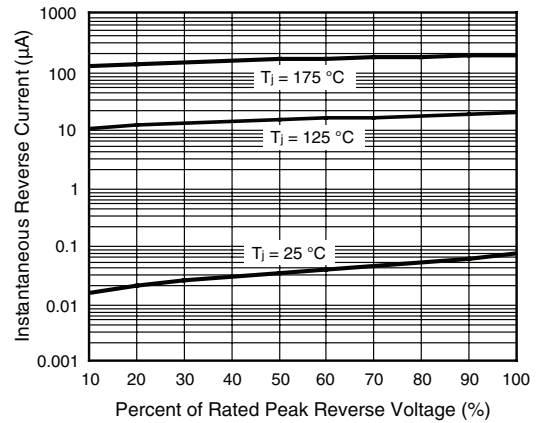

Figure 5. Typical Reverse Leakage Characteristics Per Diode

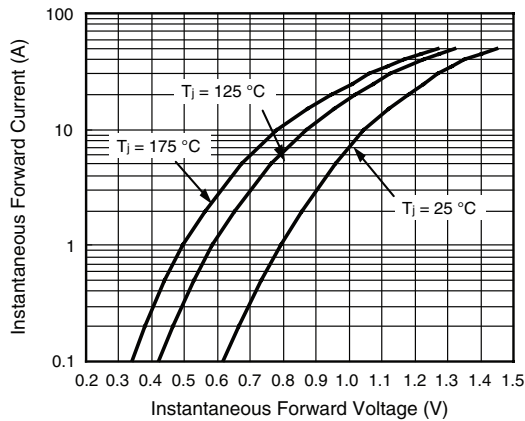

Figure 4. Typical Instantaneous Forward Characteristics Per Diode

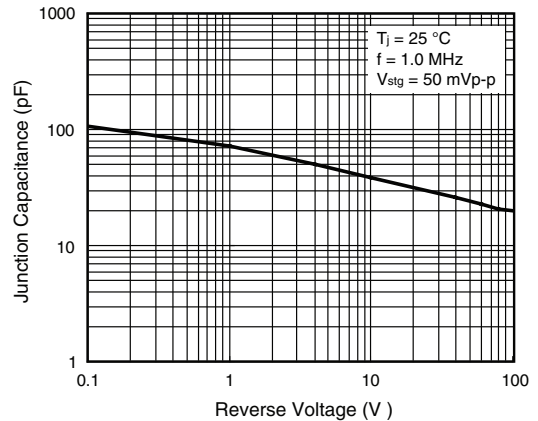

Figure 6. Typical Junction Capacitance Per Diode

UH20FCT & UHB20FCT

Vishay General Semiconductor



PACKAGE OUTLINE DIMENSIONS in inches (millimeters)

TO-220AB

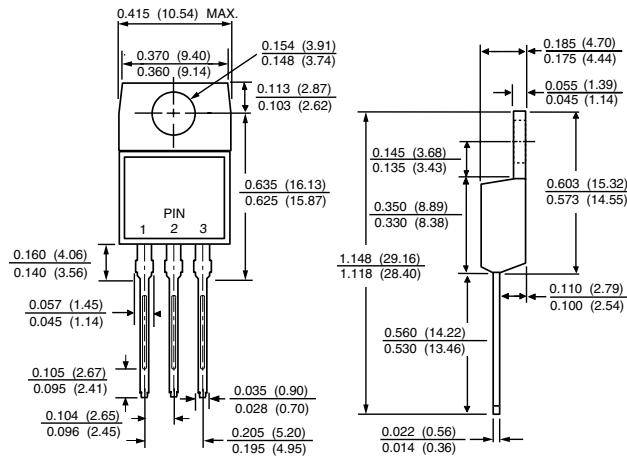

TO-263AB

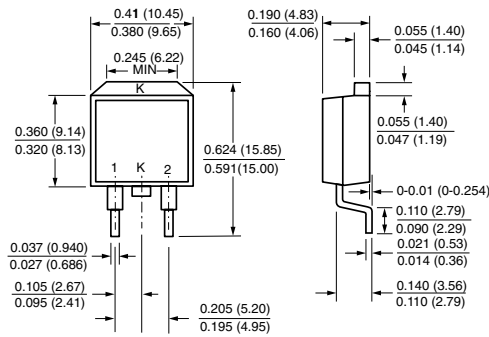

Mounting Pad Layout

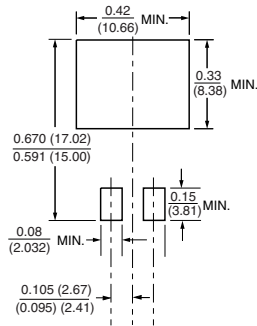



Notice

Specifications of the products displayed herein are subject to change without notice. Vishay Intertechnology, Inc., or anyone on its behalf, assumes no responsibility or liability for any errors or inaccuracies.

Information contained herein is intended to provide a product description only. No license, express or implied, by estoppel or otherwise, to any intellectual property rights is granted by this document. Except as provided in Vishay's terms and conditions of sale for such products, Vishay assumes no liability whatsoever, and disclaims any express or implied warranty, relating to sale and/or use of Vishay products including liability or warranties relating to fitness for a particular purpose, merchantability, or infringement of any patent, copyright, or other intellectual property right.

The products shown herein are not designed for use in medical, life-saving, or life-sustaining applications. Customers using or selling these products for use in such applications do so at their own risk and agree to fully indemnify Vishay for any damages resulting from such improper use or sale.

X-ON Electronics

Largest Supplier of Electrical and Electronic Components

Click to view similar products for [Rectifiers](#) category:

Click to view products by [Vishay](#) manufacturer:

Other Similar products are found below :

[70HFR40](#) [RL252-TP](#) [150KR30A](#) [1N5397](#) [NTE5841](#) [NTE6038](#) [SCF5000](#) [1N4002G](#) [1N4005-TR](#) [JANS1N6640US](#) [VS-80-7161](#) [481235F](#)
[RRE02VS6SGTR](#) [067907F](#) [MS306](#) [70HF40](#) [T85HFL60S02](#) [US2JFL-TP](#) [A1N5404G-G](#) [CRS04\(T5L,TEMQ\)](#) [ACGRA4007-HF](#)
[ACGRB207-HF](#) [CLH03\(TE16L,Q\)](#) [ACGRC307-HF](#) [ACEFC304-HF](#) [NTE6356](#) [NTE6359](#) [NTE6002](#) [NTE6023](#) [NTE6039](#) [NTE6077](#)
[85HFR60](#) [40HFR60](#) [1N1186RA](#) [70HF120](#) [85HFR80](#) [D126A45C](#) [SCF7500](#) [D251N08B](#) [SCHJ22.5K](#) [SM100](#) [SCPA2](#) [SCH10000](#) [SDHD5K](#)
[VS-12FL100S10](#) [ACGRA4001-HF](#) [D1821SH45T PR](#) [D1251S45T](#) [NTE5990](#) [NTE6358](#)