

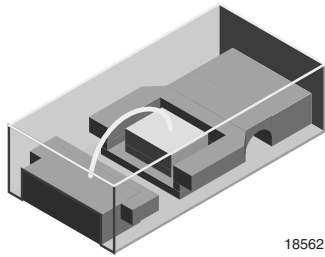

Ultrabright 0603 SMD LED



18562

DESCRIPTION

The new 0603 LED series have been designed in the smallest SMD package. This innovative 0603 LED technology opens the way to

- smaller products of higher performance
- more design in flexibility
- enhanced applications

The 0603 LED is an obvious solution for small-scale, high power products that are expected to work reliability in an arduous environment.

The reflector inside this package is filled with a mixture of epoxy and yellow converter.

This yellow converter converts the blue emission partially to yellow, which mixes the remaining blue to give white.

PRODUCT GROUP AND PACKAGE DATA

- Product group: LED
- Package: SMD 0603
- Product series: standard
- Angle of half intensity: $\pm 80^\circ$

FEATURES

- High efficient InGaN technology
- Smallest SMD package 0603 with exceptional brightness 1.6 mm x 0.8 mm x 0.6 mm (L x W x H)
- High reliability lead frame based
- Temperature range -40°C to $+100^\circ\text{C}$
- Chromaticity coordinate categorized according to CIE1931 per packing unit
- Typical color temperature 5500 K
- EIA and ICE standard package
- Compatible to IR reflow soldering
- Available in 8 mm tape reel
- Preconditioning according to JEDEC[®] level 2
- ESD-withstand voltage: up to 1 kV according to JESD22-A114-B
- AEC-Q101 qualified
- Material categorization: for definitions of compliance please see www.vishay.com/doc?99912



APPLICATIONS

- Automotive: backlighting in dashboards, switches, and keypads
- Telecommunication: indicator and backlighting in telephone and fax
- Backlighting for audio, and video equipment
- Backlighting in office equipment
- Indoor and outdoor message boards
- Flat backlight for LCDs, switches, and symbols

PARTS TABLE

PART	COLOR	LUMINOUS INTENSITY (mcd)			at I _F (mA)	COORDINATE (x, y)			at I _F (mA)	FORWARD VOLTAGE (V)			at I _F (mA)	TECHNOLOGY
		MIN.	TYP.	MAX.		MIN.	TYP.	MAX.		MIN.	TYP.	MAX.		
VLMW11R2S2-5K8L-08	White	140	-	280	10	-	0.33, 0.33	-	10	2.9	-	4.0	20	InGaN / yellow converter
VLMW11R2S1-6K-08	White	140	-	224	10	-	0.32, 0.305	-	10	2.9	-	4.0	20	InGaN / yellow converter

ABSOLUTE MAXIMUM RATINGS (T_{amb} = 25 °C, unless otherwise specified)

VLMW11..

PARAMETER	TEST CONDITION	SYMBOL	VALUE	UNIT
Reverse voltage ⁽¹⁾	I _R max. = 10 μA	V _R	5	V
DC forward current	T _{amb} ≤ 60 °C	I _F	20	mA
Surge forward current	t _p ≤ 10 μs	I _{FSM}	0.1	A
Power dissipation		P _V	80	mW
Junction temperature		T _j	110	°C
Storage temperature range		T _{stg}	-40 to +100	°C
Operating temperature range		T _{amb}	-40 to +100	°C
Thermal resistance junction-to-ambient	Mounted on PC board (pad size > 16 mm ²)	R _{thJA}	480	K/W

Note

⁽¹⁾ Driving the LED in reverse direction is suitable for short term application

OPTICAL AND ELECTRICAL CHARACTERISTICS ($T_{amb} = 25\text{ }^{\circ}\text{C}$, unless otherwise specified)
VLMW11.., WHITE

PARAMETER	TEST CONDITION	PART	SYMBOL	MIN.	TYP.	MAX.	UNIT
Luminous intensity	$I_F = 10\text{ mA}$	VLMW11R2S2-5K8L	I_V	140	-	280	mcd
		VLMW11R2S1-6K		140	-	224	mcd
Chromaticity coordinate x acc. to CIE 1931	$I_F = 10\text{ mA}$	VLMW11R2S2-5K8L	x	-	0.33	-	
		VLMW11R2S1-6K		-	0.32	-	
Chromaticity coordinate y acc. to CIE 1931	$I_F = 10\text{ mA}$	VLMW11R2S2-5K8L	y	-	0.33	-	
		VLMW11R2S1-6K		-	0.305	-	
Angle of half intensity	$I_F = 10\text{ mA}$		ϕ	-	± 80	-	$^{\circ}$
Forward voltage	$I_F = 20\text{ mA}$		V_F	2.9	-	4.0	V
Temperature coefficient of V_F	$I_F = 10\text{ mA}$		TC_{VF}	-	-3	-	mV/K
Temperature coefficient of I_V	$I_F = 10\text{ mA}$		TC_{IV}	-	-0.4	-	%/K

LUMINOUS INTENSITY CLASSIFICATION

GROUP	LIGHT INTENSITY (mcd)			
	STANDARD	OPTIONAL	MIN.	MAX.
R	2	140	180	
S	1	180	224	
	2	224	280	

CROSSING TABLE

VISHAY	OSRAM
VLMW11R2S2	LWL28G-R2S2

Note

- Luminous intensity is tested at a current pulse duration of 25 ms and an accuracy of $\pm 11\%$.
The above type numbers represent the order groups which include only a few brightness groups. Only one group will be shipped on each reel (there will be no mixing of two groups on each reel). In order to ensure availability, single brightness groups are not be orderable.
In a similar manner for colors where wavelength groups are measured and binned, single wavelength groups will be shipped on any one reel.
In order to ensure availability, single wavelength groups are not be orderable

CHROMATICITY COORDINATED GROUPS FOR WHITE SMD LED

	X	Y		X	Y
5L	0.291	0.268	7L	0.330	0.330
	0.285	0.279		0.330	0.347
	0.307	0.312		0.347	0.371
	0.310	0.297		0.345	0.352
5K	0.296	0.259	7K	0.330	0.310
	0.291	0.268		0.330	0.330
	0.310	0.297		0.338	0.342
	0.313	0.284		0.352	0.344
6L	0.310	0.297	8L	0.345	0.352
	0.307	0.312		0.347	0.371
	0.330	0.347		0.367	0.401
	0.330	0.330		0.364	0.380
6K	0.313	0.284	8K	0.352	0.344
	0.310	0.297		0.338	0.342
	0.330	0.330		0.364	0.380
	0.330	0.310		0.360	0.357

Note

- Chromaticity coordinate groups are tested at a current pulse duration of 25 ms and a tolerance of ± 0.01



TYPICAL CHARACTERISTICS ($T_{amb} = 25\text{ }^{\circ}\text{C}$, unless otherwise specified)

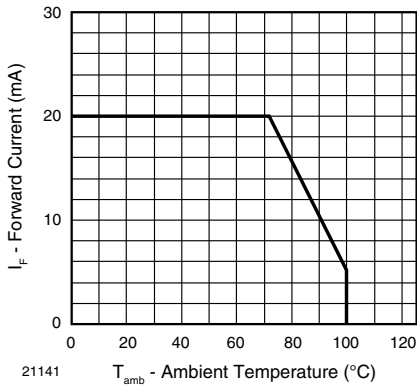

Fig. 1 - Forward Current vs. Ambient Temperature

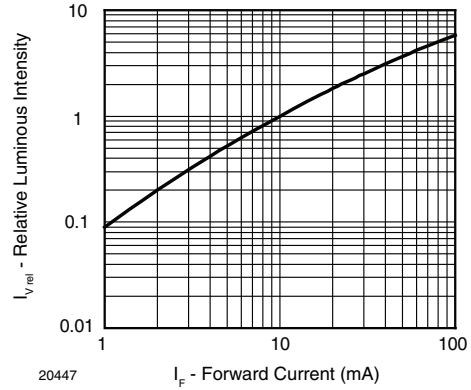

Fig. 4 - Relative Luminous Intensity vs. Forward Current

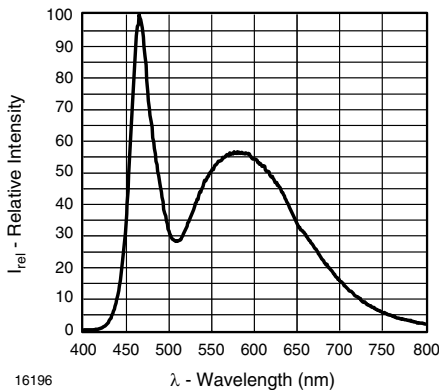

Fig. 2 - Relative Intensity vs. Wavelength

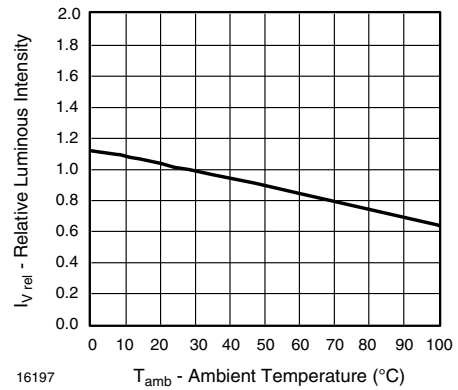

Fig. 5 - Relative Luminous Intensity vs. Ambient Temperature

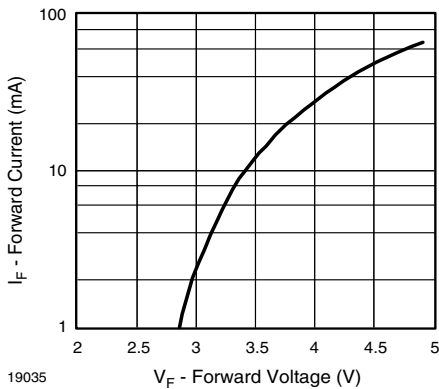

Fig. 3 - Forward Current vs. Forward Voltage

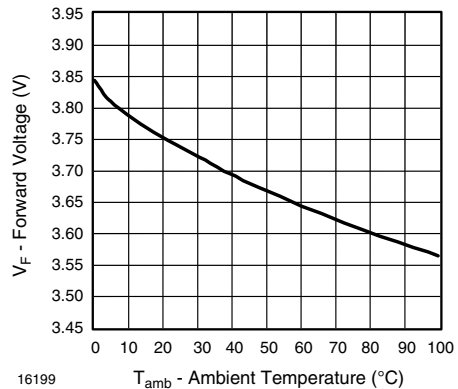

Fig. 6 - Forward Voltage vs. Ambient Temperature

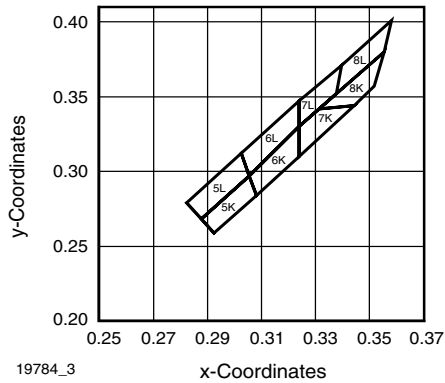
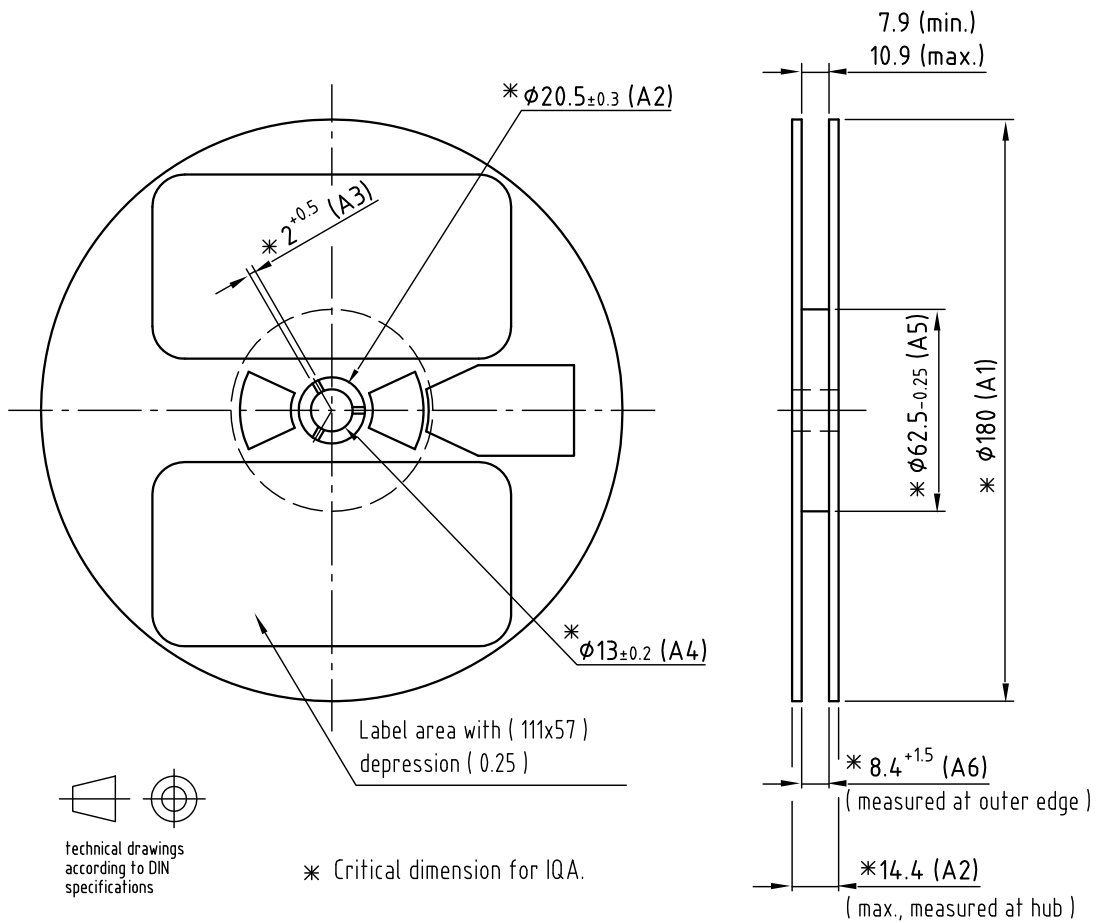

Fig. 7 - Coordinates of Colorgroups

REEL DIMENSIONS in millimeters



Drawing-No.: 9.800-5086.01-4
Issue: 1; 29.04.04
19043

Not indicated tolerances ± 0.05
Material: black static dissipative



TAPE DIMENSIONS in millimeters

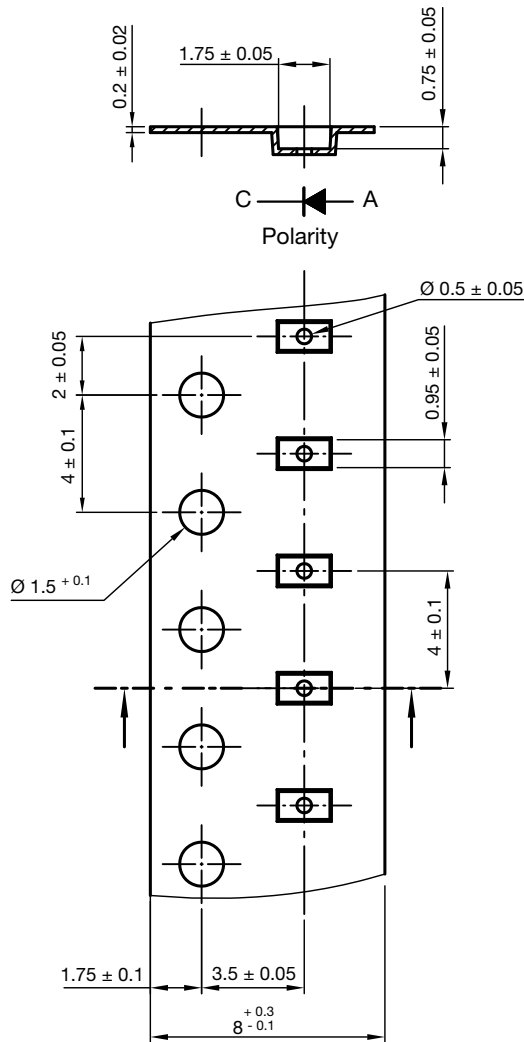

Technical drawings according to DIN specifications

Not indicated tolerances ± 0.05
Material: Conductive black PC

Drawing-No.: 9.700-5290.01-4
Issue: 3; 24.09.13



PACKAGE DIMENSIONS in millimeters

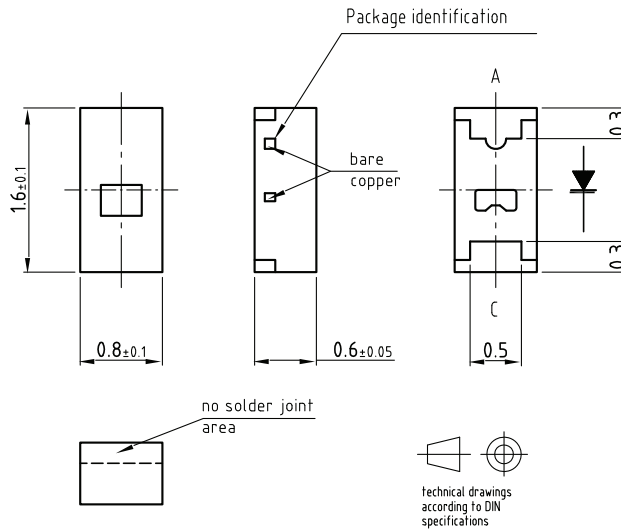

Not indicated tolerances ±0.1

Recommended solder pad

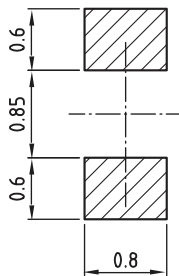

Drawing-No.: 6.541-5056.01-4

Issue: 2; 04.05.05

19426

SOLDERING PROFILE

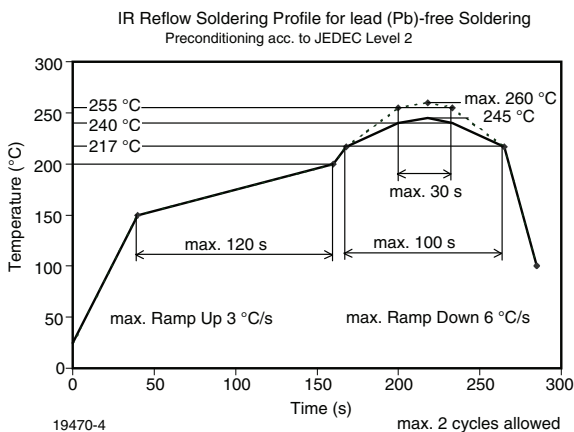
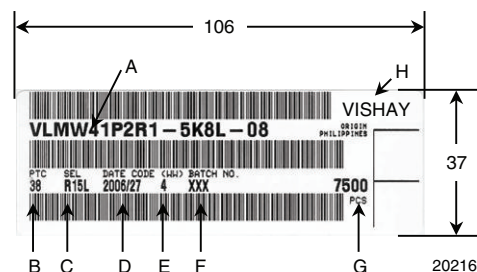

Fig. 8 - Vishay Lead (Pb)-free Reflow Soldering Profile (according to J-STD-020C)

BAR CODE PRODUCT LABEL (example)



- A. Type of component
- B. Manufacturing plant
- C. SEL - selection code (bin):
e.g.: R1 = code for luminous intensity group
5L = code for chrom. coordinate group
- D. Date code year / week
- E. Day code (e.g. 4: Thursday)
- F. Batch no.
- G. Total quantity
- H. Company code



DRY PACKING

The reel is packed in an anti-humidity bag to protect the devices from absorbing moisture during transportation and storage.

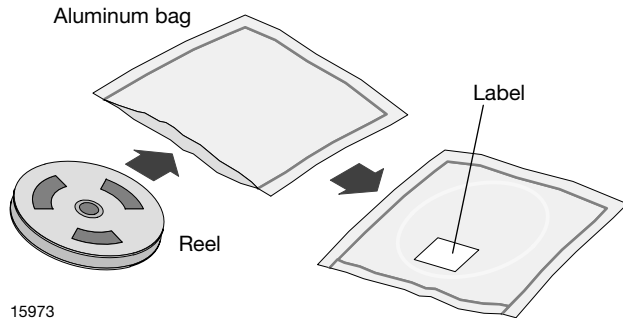

ESD PRECAUTION

Proper storage and handling procedures should be followed to prevent ESD damage to the devices especially when they are removed from the antistatic shielding bag. Electrostatic sensitive devices warning labels are on the packaging.

VISHAY SEMICONDUCTORS STANDARD BAR CODE LABELS

The Vishay Semiconductors standard bar code labels are printed at final packing areas. The labels are on each packing unit and contain Vishay Semiconductors specific data.

FINAL PACKING

The sealed reel is packed into a cardboard box. A secondary cardboard box is used for shipping purposes.

RECOMMENDED METHOD OF STORAGE

Dry box storage is recommended as soon as the aluminum bag has been opened to prevent moisture absorption. The following conditions should be observed, if dry boxes are not available:

- Storage temperature 10 °C to 30 °C
- Storage humidity ≤ 60 % RH max.

After more than 1 year under these conditions moisture content will be too high for reflow soldering.

In case of moisture absorption, the devices will recover to the former condition by drying under the following condition:

- 192 h at 40 °C + 5 °C / - 0 °C and < 5 % RH (dry air / nitrogen) or
- 96 h at 60 °C + 5 °C and < 5 % RH for all device containers or
- 24 h at 100 °C + 5 °C not suitable for reel or tubes.

An EIA JEDEC standard JESD22-A112 level 2 label is included on all dry bags.

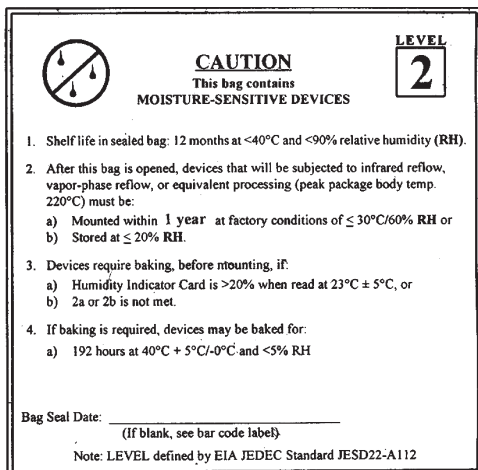

Example of JESD22-A112 level 2 label



Disclaimer

ALL PRODUCT, PRODUCT SPECIFICATIONS AND DATA ARE SUBJECT TO CHANGE WITHOUT NOTICE TO IMPROVE RELIABILITY, FUNCTION OR DESIGN OR OTHERWISE.

Vishay Intertechnology, Inc., its affiliates, agents, and employees, and all persons acting on its or their behalf (collectively, "Vishay"), disclaim any and all liability for any errors, inaccuracies or incompleteness contained in any datasheet or in any other disclosure relating to any product.

Vishay makes no warranty, representation or guarantee regarding the suitability of the products for any particular purpose or the continuing production of any product. To the maximum extent permitted by applicable law, Vishay disclaims (i) any and all liability arising out of the application or use of any product, (ii) any and all liability, including without limitation special, consequential or incidental damages, and (iii) any and all implied warranties, including warranties of fitness for particular purpose, non-infringement and merchantability.

Statements regarding the suitability of products for certain types of applications are based on Vishay's knowledge of typical requirements that are often placed on Vishay products in generic applications. Such statements are not binding statements about the suitability of products for a particular application. It is the customer's responsibility to validate that a particular product with the properties described in the product specification is suitable for use in a particular application. Parameters provided in datasheets and / or specifications may vary in different applications and performance may vary over time. All operating parameters, including typical parameters, must be validated for each customer application by the customer's technical experts. Product specifications do not expand or otherwise modify Vishay's terms and conditions of purchase, including but not limited to the warranty expressed therein.

Except as expressly indicated in writing, Vishay products are not designed for use in medical, life-saving, or life-sustaining applications or for any other application in which the failure of the Vishay product could result in personal injury or death. Customers using or selling Vishay products not expressly indicated for use in such applications do so at their own risk. Please contact authorized Vishay personnel to obtain written terms and conditions regarding products designed for such applications.

No license, express or implied, by estoppel or otherwise, to any intellectual property rights is granted by this document or by any conduct of Vishay. Product names and markings noted herein may be trademarks of their respective owners.

X-ON Electronics

Largest Supplier of Electrical and Electronic Components

Click to view similar products for [Standard LEDs - SMD category](#):

Click to view products by [Vishay manufacturer](#):

Other Similar products are found below :

[LTST-C19GD2WT](#) [LTST-N683GBEW](#) [LTW-170ZDC](#) [LTW-M140SZS40](#) [598-8110-100F](#) [598-8170-100F](#) [598-8610-202F](#) [67-22VRVGC/TR8](#) [AAAF5060QBFSEEZGS](#) [HLMP-6305-L0011](#) [ALMD-LB36-SV002](#) [APT1608QGW](#) [15-21UYC/S530-A3/TR8](#) [EASV1803BA0](#) [LG M67K-H1J2-24-0-2-R18-Z](#) [LS A676-P2S1-1](#) [SML310BATT86](#) [SML-512VWT86A](#) [SML-LX0606SISUGC/A](#) [SML-LXL1307SRC-TR](#) [SML-LXR851SIUPGUBC](#) [LT1ED53A](#) [FAT801-S](#) [AM27ZGC03](#) [APB3025SGNC](#) [APFA3010SURKCGKQBDC](#) [APHK1608VGCA](#) [APT2012QGW](#) [CLX6D-FKB-CN1R1H1BB7D3D3](#) [LTST-C250KGKT](#) [LTW-020ZDCG](#) [LTW-21TS5](#) [LTW-220DS5](#) [JANTXM19500/521-02](#) [UYGT801-S](#) [LO T67F-V1AB-24-1](#) [YGFR411-H](#) [598-8330-117F](#) [SML-LX0402IC-TR](#) [CMDA20AYAA7D1S](#) [CMDA16AYDR7A1X](#) [339-1SURYGW/S530-A2](#) [598-8040-100F](#) [598-8070-100F](#) [598-8140-100F](#) [598-8610-200F](#) [EAPL3527GA5](#) [67-11/BHC-M1N2B8Y/2A0](#) [SML-LXL1209SYC/ATR](#) [EASV3020YGA0](#)