

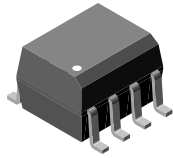

## Optocoupler, Phototransistor Output, with Base Connection in SOIC-8 Package

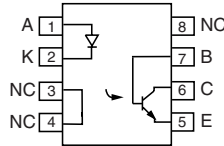

1179002



### DESCRIPTION

The VO211AT, VO212AT, VO213AT are optically coupled pairs with a gallium arsenide infrared LED and silicon NPN phototransistor. Signal information, including a DC level, can be transmitted by the device while maintaining a high degree of electrical isolation between input and output.

The VO211AT, VO212AT, VO213AT comes in a standard SOIC-8 small outline package for surface mounting which makes it ideally suited for high density applications with limited space.

### FEATURES

- Isolation test voltage, 4000 V<sub>RMS</sub>
- Lead (Pb)-free component
- Component in accordance to RoHS 2002/95/EC and WEEE 2002/96/EC



RoHS COMPLIANT

### AGENCY APPROVALS

- UL1577, file no. E52744 system code Y
- CUL - file no. E52744, equivalent to CSA bulletin 5A
- DIN EN 60747-5-5 (VDE 0884) available with option 1

ORDER INFORMATION	
PART	REMARKS
VO211AT	CTR > 20 %, SOIC-8
VO212AT	CTR > 50 %, SOIC-8
VO213AT	CTR > 100 %, SOIC-8

ABSOLUTE MAXIMUM RATINGS				
PARAMETER	TEST CONDITION	SYMBOL	VALUE	UNIT
<b>INPUT</b>				
Peak reverse voltage		V <sub>R</sub>	6	V
Peak forward current	1 μs, 300 pps	I <sub>FM</sub>	1	A
Forward continuous current		I <sub>F</sub>	60	mA
Power dissipation		P <sub>diss</sub>	90	mW
Derate linearly from 25 °C			1.2	mW/°C
<b>OUTPUT</b>				
Collector emitter breakdown voltage		BV <sub>CEO</sub>	30	V
Emitter collector breakdown voltage		BV <sub>ECO</sub>	7	V
Collector base breakdown voltage		BV <sub>CBO</sub>	70	V
I <sub>Cmax, DC</sub>		I <sub>Cmax, DC</sub>	50	mA
I <sub>Cmax</sub>	t < 1 ms	I <sub>Cmax</sub>	100	mA
Power dissipation		P <sub>diss</sub>	150	mW
Derate linearly from 25 °C			2	mW/°C
<b>COUPLER</b>				
Isolation test voltage		V <sub>ISO</sub>	4000	V <sub>RMS</sub>
Total package dissipation	LED and detector	P <sub>tot</sub>	240	mW
Derate linearly from 25 °C			3.2	mW/°C
Storage temperature		T <sub>stg</sub>	- 40 to + 150	°C
Operating temperature		T <sub>amb</sub>	- 40 to + 100	°C
Soldering time	at 260 °C	T <sub>slid</sub>	10	s

### Note

T<sub>amb</sub> = 25 °C, unless otherwise specified.

Stresses in excess of the absolute maximum ratings can cause permanent damage to the device. Functional operation of the device is not implied at these or any other conditions in excess of those given in the operational sections of this document. Exposure to absolute maximum ratings for extended periods of the time can adversely affect reliability.

# VO211AT, VO212AT, VO213AT



Vishay Semiconductors Optocoupler, Phototransistor Output, with Base Connection in SOIC-8 Package

ELECTRICAL CHARACTERISTICS							
PARAMETER	TEST CONDITION	PART	SYMBOL	MIN.	TYP.	MAX.	UNIT
<b>INPUT</b>							
Forward voltage	$I_F = 10 \text{ mA}$		$V_F$		1.3	1.5	V
Reverse current	$V_R = 6 \text{ V}$		$I_R$		0.1	100	$\mu\text{A}$
Capacitance	$V_R = 0 \text{ V}$		$C_O$		13		pF
<b>OUTPUT</b>							
Collector emitter breakdown voltage	$I_C = 100 \mu\text{A}$		$BV_{CEO}$	30			V
Emitter collector breakdown voltage	$I_E = 10 \mu\text{A}$		$BV_{ECO}$	7			V
Collector base breakdown voltage	$I_C = 100 \mu\text{A}$		$BV_{CBO}$	100			V
Collector base current			$I_{CBO}$			1	nA
Emitter base current			$I_{EBO}$			1	nA
Collector dark current	$V_{CE} = 10 \text{ V}$		$I_{CEO}$		5	50	nA
Collector emitter capacitance	$V_{CE} = 0 \text{ V}$		$C_{CE}$		10		pF
Saturation voltage, collector emitter	$I_F = 10 \text{ mA}$		$V_{CEsat}$			0.4	V
<b>COUPLER</b>							
Isolation test voltage	1 s		$V_{ISO}$	4000			$V_{RMS}$

## Note

$T_{amb} = 25 \text{ }^\circ\text{C}$ , unless otherwise specified.

Minimum and maximum values were tested requirements. Typical values are characteristics of the device and are the result of engineering evaluations. Typical values are for information only and are not part of the testing requirements.

CURRENT TRANSFER RATIO							
PARAMETER	TEST CONDITION	PART	SYMBOL	MIN.	TYP.	MAX.	UNIT
Current transfer ratio	$I_F = 10 \text{ mA}$ , $V_{CE} = 5 \text{ V}$	VO211AT	CTR	20	50		%
		VO212AT	CTR	50	80		%
		VO213AT	CTR	100	130		%

SWITCHING CHARACTERISTICS							
PARAMETER	TEST CONDITION	PART	SYMBOL	MIN.	TYP.	MAX.	UNIT
Turn-on time	$I_C = 2 \text{ mA}$ , $R_L = 100 \Omega$ , $V_{CC} = 10 \text{ V}$		$t_{on}$		3		$\mu\text{s}$
Turn-off time	$I_C = 2 \text{ mA}$ , $R_L = 100 \Omega$ , $V_{CC} = 10 \text{ V}$		$t_{off}$		3		$\mu\text{s}$
Rise time	$I_C = 2 \text{ mA}$ , $R_L = 100 \Omega$ , $V_{CC} = 10 \text{ V}$		$t_r$		3		$\mu\text{s}$
Fall time	$I_C = 2 \text{ mA}$ , $R_L = 100 \Omega$ , $V_{CC} = 10 \text{ V}$		$t_f$		2		$\mu\text{s}$

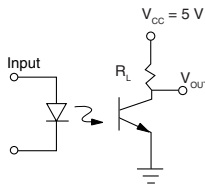

iii215at\_17

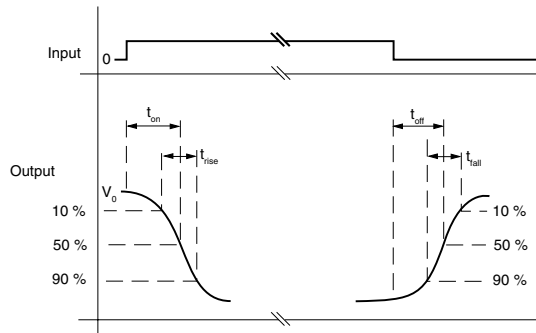
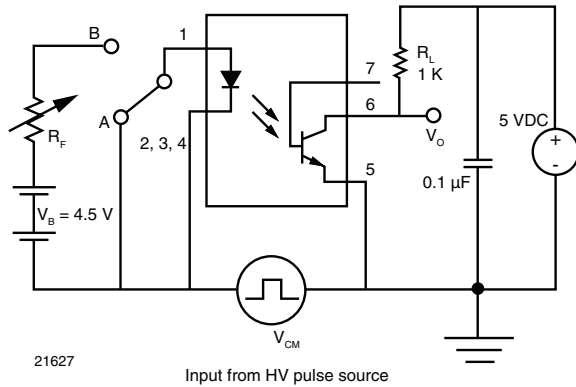
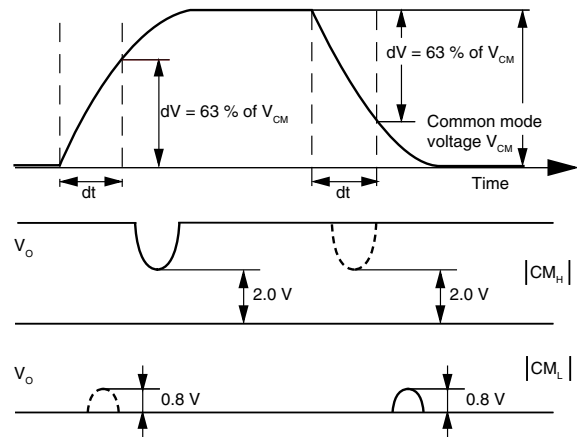

Fig. 1 - Switching Test Circuit

COMMON MODE TRANSIENT IMMUNITY						
PARAMETER	TEST CONDITION	SYMBOL	MIN.	TYP.	MAX.	UNIT
Common mode transient immunity at logic high	$V_{CM} = 1000 \text{ V}_{P-P}$ , $R_L = 1 \text{ k}\Omega$ , $I_F = 0 \text{ mA}$	$ C_{MH} $		5000		$\text{V}/\mu\text{s}$
Common mode transient immunity at logic low	$V_{CM} = 1000 \text{ V}_{P-P}$ , $R_L = 1 \text{ k}\Omega$ , $I_F = 10 \text{ mA}$	$ C_{ML} $		5000		$\text{V}/\mu\text{s}$



21627



21626

Fig. 2 - Test Circuit for Common Mode Transient Immunity

SAFETY AND INSULATION RATINGS						
PARAMETER	TEST CONDITION	SYMBOL	MIN.	TYP.	MAX.	UNIT
Climatic classification (according to IEC 68 part 1)				40/100/21		
Polution degree				2		
Comparative tracking index		CTI	175		399	
Isolation test voltage	1 s	$V_{ISO}$	4000			$V_{RMS}$
Peak transient overvoltage		$V_{IOTM}$	6000			V
Peak insulation voltage		$V_{IORM}$	560			V
Resistance (input to output)		$R_{IO}$		100		$G\Omega$
Safety rating - power output		$P_{SO}$			350	mW
Safety rating - input current		$I_{SI}$			150	mA
Safety rating - temperature		$T_{SI}$			165	$^{\circ}C$
External creepage distance			4			mm
External clearance distance			4			mm
Internal creepage distance			3.3			mm
Insulation thickness			0.2			mm

**Note**

As per IEC 60747-5-2, § 7.4.3.8.1, this optocoupler is suitable for “safe electrical insulation” only within the safety ratings. Compliance with the safety ratings shall be ensured by means of protective circuits.

**TYPICAL CHARACTERISTICS**

$T_{amb} = 25^{\circ}C$ , unless otherwise specified

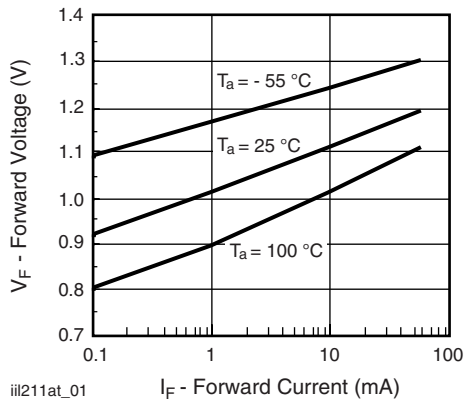

Fig. 3 - Forward Voltage vs. Forward Current

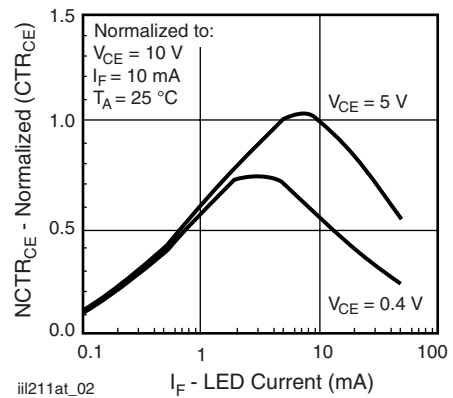

Fig. 4 - Normalized Non-Saturated and Saturated  $CTR_{CE}$  vs. LED Current



# VO211AT, VO212AT, VO213AT

Optocoupler, Phototransistor Output, with Vishay Semiconductors  
Base Connection in SOIC-8 Package

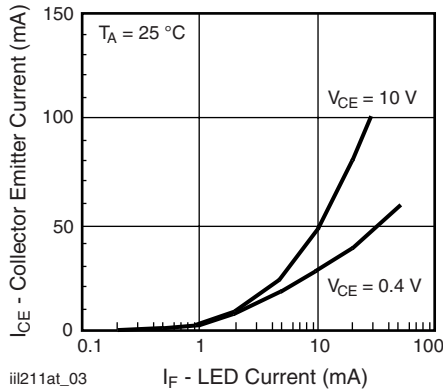

Fig. 5 - Collector Emitter Current vs. LED Current

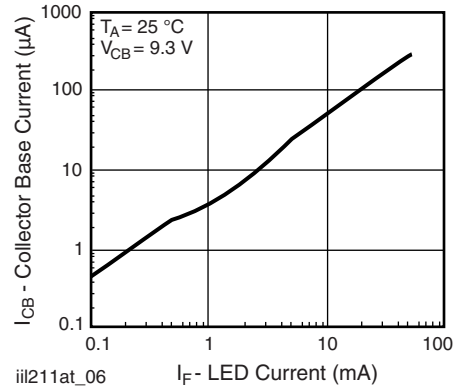

Fig. 8 - Collector Base Photocurrent vs. LED Current

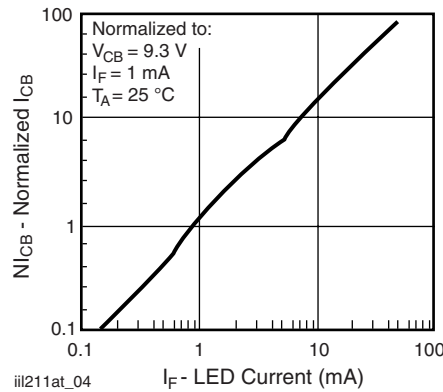

Fig. 6 - Normalized Collector Base Photocurrent vs. LED Current

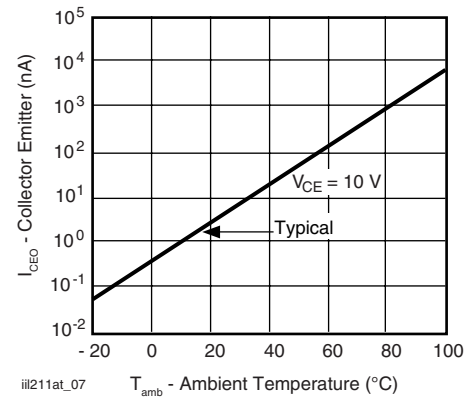

Fig. 9 - Collector Emitter Leakage Current vs. Temperature

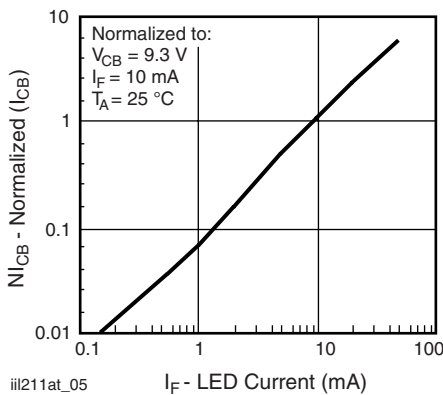

Fig. 7 - Normalized Collector Base Photocurrent vs. LED Current

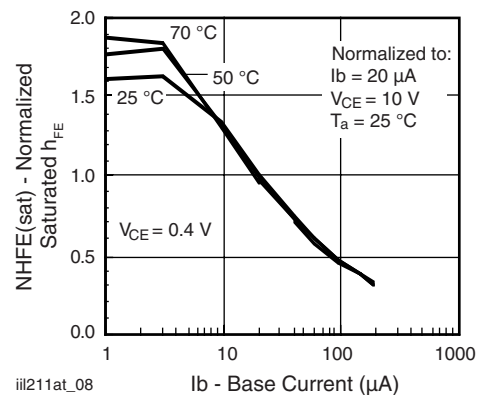
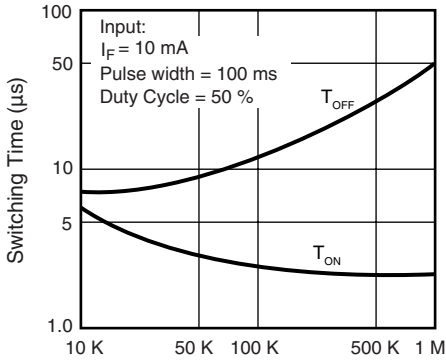

Fig. 10 - Normalized Saturated  $h_{FE}$  vs. Base Current and Temperature

# VO211AT, VO212AT, VO213AT



Vishay Semiconductors Optocoupler, Phototransistor Output, with Base Connection in SOIC-8 Package



iii211at\_09 Base Emitter Resistances,  $R_{BE}$  ( $\Omega$ )

Fig. 11 - Typical Switching Characteristics vs. Base Resistance (Saturated Operation)

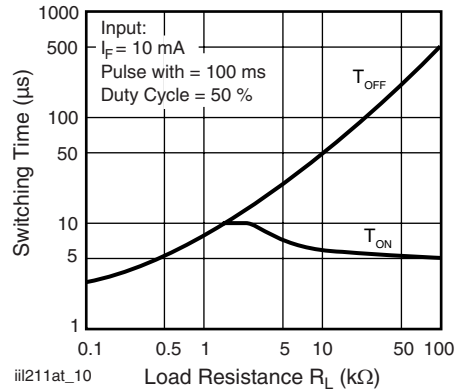

iii211at\_10 Load Resistance  $R_L$  ( $k\Omega$ )

Fig. 12 - Typical Switching Times vs. Load Resistance

## PACKAGE DIMENSIONS in inches (millimeters)

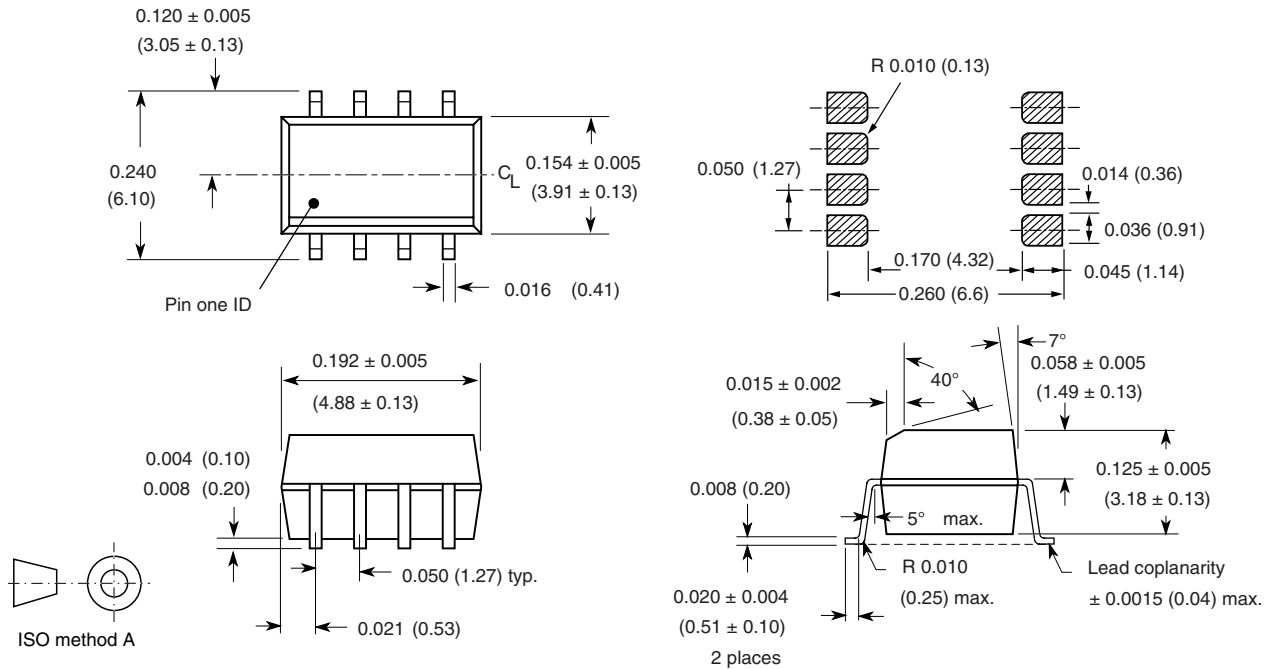

i178003



## OZONE DEPLETING SUBSTANCES POLICY STATEMENT

It is the policy of Vishay Semiconductor GmbH to

1. Meet all present and future national and international statutory requirements.
2. Regularly and continuously improve the performance of our products, processes, distribution and operating systems with respect to their impact on the health and safety of our employees and the public, as well as their impact on the environment.

It is particular concern to control or eliminate releases of those substances into the atmosphere which are known as ozone depleting substances (ODSs).

The Montreal Protocol (1987) and its London Amendments (1990) intend to severely restrict the use of ODSs and forbid their use within the next ten years. Various national and international initiatives are pressing for an earlier ban on these substances.

Vishay Semiconductor GmbH has been able to use its policy of continuous improvements to eliminate the use of ODSs listed in the following documents.

1. Annex A, B and list of transitional substances of the Montreal Protocol and the London Amendments respectively.
2. Class I and II ozone depleting substances in the Clean Air Act Amendments of 1990 by the Environmental Protection Agency (EPA) in the USA.
3. Council Decision 88/540/EEC and 91/690/EEC Annex A, B and C (transitional substances) respectively.

Vishay Semiconductor GmbH can certify that our semiconductors are not manufactured with ozone depleting substances and do not contain such substances.

We reserve the right to make changes to improve technical design  
and may do so without further notice.

Parameters can vary in different applications. All operating parameters must be validated for each customer application by the customer. Should the buyer use Vishay Semiconductors products for any unintended or unauthorized application, the buyer shall indemnify Vishay Semiconductors against all claims, costs, damages, and expenses, arising out of, directly or indirectly, any claim of personal damage, injury or death associated with such unintended or unauthorized use.

Vishay Semiconductor GmbH, P.O.B. 3535, D-74025 Heilbronn, Germany



## Disclaimer

All product specifications and data are subject to change without notice.

Vishay Intertechnology, Inc., its affiliates, agents, and employees, and all persons acting on its or their behalf (collectively, "Vishay"), disclaim any and all liability for any errors, inaccuracies or incompleteness contained herein or in any other disclosure relating to any product.

Vishay disclaims any and all liability arising out of the use or application of any product described herein or of any information provided herein to the maximum extent permitted by law. The product specifications do not expand or otherwise modify Vishay's terms and conditions of purchase, including but not limited to the warranty expressed therein, which apply to these products.

No license, express or implied, by estoppel or otherwise, to any intellectual property rights is granted by this document or by any conduct of Vishay.

The products shown herein are not designed for use in medical, life-saving, or life-sustaining applications unless otherwise expressly indicated. Customers using or selling Vishay products not expressly indicated for use in such applications do so entirely at their own risk and agree to fully indemnify Vishay for any damages arising or resulting from such use or sale. Please contact authorized Vishay personnel to obtain written terms and conditions regarding products designed for such applications.

Product names and markings noted herein may be trademarks of their respective owners.



## X-ON Electronics

Largest Supplier of Electrical and Electronic Components

*Click to view similar products for [Transistor Output Optocouplers](#) category:*

*Click to view products by [Vishay](#) manufacturer:*

Other Similar products are found below :

[LTV-814S-TA](#) [LTV-824HS](#) [LTV-852S](#) [66095-001](#) [6N136-X017T](#) [MCT6-X007](#) [MOC8101-X017T](#) [PS2561A-1-W-A](#) [PS2561B-1-L-A](#)  
[PS2561L-1-V-A](#) [MRF658](#) [IL755-1X007](#) [ILD74-X001](#) [ILQ615-2X017](#) [ILQ615-3X016](#) [LDA102S](#) [LDA110S](#) [PS2561-1-V-W-A](#) [PS2561AL-1-V-A](#) [PS2561L1-1-L-A](#) [PS2701A-1-F3-P-A](#) [PS2801-1-F3-P-A](#) [PS2911-1-L-AX](#) [CNY17-2X017](#) [CNY17-4X001](#) [CNY17-4X017](#) [CNY17F-1X007](#) [CNY17F-2X017](#) [CNY17F-4X001](#) [CNY17G-1](#) [LTV-214](#) [LTV-702VB](#) [LTV-733S](#) [LTV-816S-TA](#) [LTV-825S](#) [TCET1113](#) [TCET2100](#)  
[4N25-X007T](#) [IL215AT](#) [ILD615-1X007](#) [ILQ2-X007](#) [VOS615A-2T](#) [WPPC-A11066AA](#) [WPPC-A11066AD](#) [WPPC-A11084ASS](#) [WPPC-A21068AA](#) [WPPC-D11066AA](#) [WPPC-D21068ED](#) [WPPC-D410616EA](#) [WPPC-D410616ED](#)