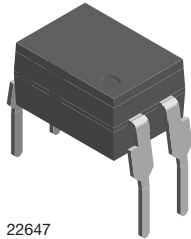
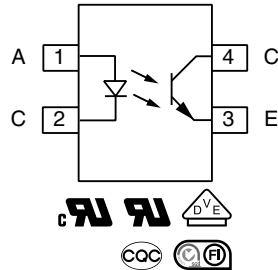


# Low Input Current Optocoupler, Phototransistor Output, High Reliability, 5300 V<sub>RMS</sub>



22647



## DESCRIPTION

The 110 °C rated VO615C series feature a high current transfer ratio, low coupling capacitance and high isolation voltage. These couplers have a GaAs infrared diode emitter, which is optically coupled to a silicon planar phototransistor detector, and is incorporated in a plastic DIP-4 package.

The coupling devices are designed for signal transmission between two electrically separated circuits.

## FEATURES

- Copper lead-frame
- Operating temperature from -55 °C to +110 °C
- Isolation test voltage, 5300 V<sub>RMS</sub>
- High collector emitter voltage, V<sub>CEO</sub> = 80 V
- Low saturation voltage
- Fast switching times
- Low CTR degradation
- Low coupling capacitance
- End stackable, 0.100" (2.54 mm) spacing
- Material categorization: for definitions of compliance please see [www.vishay.com/doc?99912](http://www.vishay.com/doc?99912)



## APPLICATIONS

- AC adapters
- SMPS
- PLC
- Factory automation
- Game consoles

## AGENCY APPROVALS

The safety application model number covering all products in this datasheet is VO615C. This model number should be used when consulting safety agency documents.

- UL1577, file no. E52744
- cUL tested to CSA 22.2 bulletin 5A
- DIN EN 60747-5-5 (VDE 0884), available with option 1
- FIMKO EN60065 and EN60950-1, file no. FI 27409
- CQC GB8898-2001

ORDERING INFORMATION				
<div style="display: flex; justify-content: space-around; align-items: center;"> <div style="border: 1px solid black; padding: 2px;">V</div> <div style="border: 1px solid black; padding: 2px;">O</div> <div style="border: 1px solid black; padding: 2px;">6</div> <div style="border: 1px solid black; padding: 2px;">1</div> <div style="border: 1px solid black; padding: 2px;">5</div> <div style="border: 1px solid black; padding: 2px;">C</div> <div style="border: 1px solid black; padding: 2px;">-</div> <div style="border: 1px solid black; padding: 2px;">#</div> <div style="border: 1px solid black; padding: 2px;">X</div> <div style="border: 1px solid black; padding: 2px;">0</div> <div style="border: 1px solid black; padding: 2px;">#</div> <div style="border: 1px solid black; padding: 2px;">#</div> <div style="border: 1px solid black; padding: 2px;">T</div> </div> <p style="text-align: center;">PART NUMBER</p> <p style="text-align: center;">CTR BIN</p> <p style="text-align: center;">PACKAGE OPTION</p> <p style="text-align: center;">TAPE AND REEL</p>	<p>DIP-4 7.62 mm</p>	<p>Option 6 10.16 mm</p>		
	<p>Option 9 &gt; 8 mm</p>			
AGENCY CERTIFIED/PACKAGE	CTR (%)			
	10 mA			
<b>UL, cUL, FIMKO, CQC</b>	<b>40 to 80</b>	<b>63 to 125</b>	<b>100 to 200</b>	<b>160 to 320</b>
DIP-4	VO615C-1	-	-	-
<b>VDE, UL, cUL, FIMKO, CQC (option 1)</b>	<b>40 to 80</b>	<b>63 to 125</b>	<b>100 to 200</b>	<b>160 to 320</b>
DIP-4, 400 mil, option 6	-	VO615C-2X016	VO615C-3X016	VO615C-4X016
SMD-4, option 9	-	VO615C-2X019T, VO615C-2X019T1 <sup>(1)</sup>	-	-

### Notes

- Additional options may be available, please contact the sales office.
- (1) T1 rotation in tape and reel packaging.

<b>ABSOLUTE MAXIMUM RATINGS</b> ( $T_{amb} = 25\text{ }^{\circ}\text{C}$ , unless otherwise specified)				
PARAMETER	TEST CONDITION	SYMBOL	VALUE	UNIT
<b>INPUT</b>				
Reverse voltage		$V_R$	6	V
Forward current		$I_F$	60	mA
Forward surge current	$t_p \leq 10\text{ }\mu\text{s}$	$I_{FSM}$	1.5	A
Power dissipation	at $25\text{ }^{\circ}\text{C}$	$P_{diss}$	70	mW
<b>OUTPUT</b>				
Collector emitter voltage		$V_{CEO}$	80	V
Emitter collector voltage		$V_{ECO}$	7	V
Collector current		$I_C$	50	mA
	$t_p \leq 1\text{ ms}$		100	mA
Output power dissipation	at $25\text{ }^{\circ}\text{C}$	$P_{diss}$	150	mW
<b>COUPLER</b>				
Isolation test voltage (RMS)	$t = 1\text{ min}$	$V_{ISO}$	5300	$V_{RMS}$
Total power dissipation		$P_{tot}$	200	mW
Operation temperature		$T_{amb}$	-55 to +110	$^{\circ}\text{C}$
Storage temperature range		$T_{stg}$	-55 to +150	$^{\circ}\text{C}$
Junction temperature		$T_j$	125	$^{\circ}\text{C}$
Soldering temperature <sup>(1)</sup>	2 mm from case, $\leq 10\text{ s}$	$T_{sld}$	260	$^{\circ}\text{C}$

**Notes**

- Stresses in excess of the absolute maximum ratings can cause permanent damage to the device. Functional operation of the device is not implied at these or any other conditions in excess of those given in the operational sections of this document. Exposure to absolute maximum ratings for extended periods of the time can adversely affect reliability.
- <sup>(1)</sup> Refer to reflow profile for soldering conditions for surface mounted devices (SMD), and wave profile for soldering conditions for through hole devices (DIP), please go to "Assembly Instructions" ([www.vishay.com/doc?80054](http://www.vishay.com/doc?80054)).

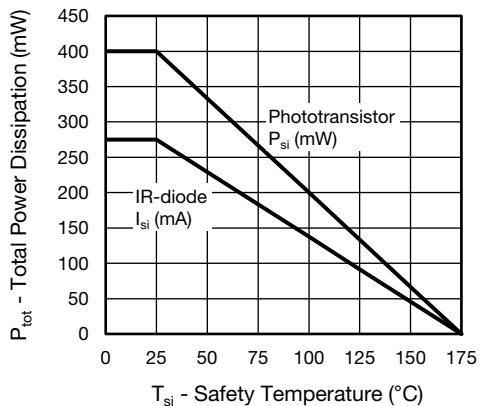


Fig. 1 - Total Power Dissipation vs. Safety Temperature

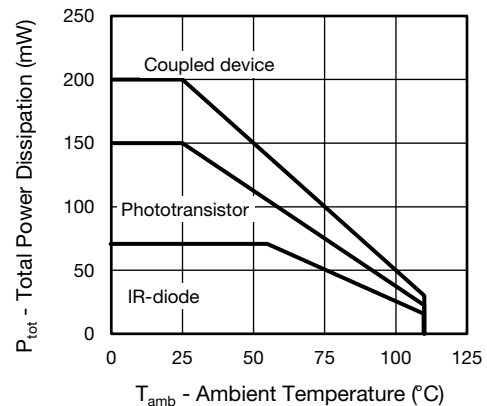


Fig. 2 - Total Power Dissipation vs. Ambient Temperature

<b>ELECTRICAL CHARACTERISTICS</b> ( $T_{amb} = 25\text{ }^{\circ}\text{C}$ , unless otherwise specified)						
PARAMETER	TEST CONDITION	SYMBOL	MIN.	TYP.	MAX.	UNIT
<b>INPUT</b>						
Forward voltage	$I_F = 60\text{ mA}$	$V_F$		1.35	1.6	V
Reverse current	$V_R = 6\text{ V}$	$I_R$		0.01	10	$\mu\text{A}$
Junction capacitance	$V_R = 0\text{ V}$ , $f = 1\text{ MHz}$	$C_j$		9		pF
<b>OUTPUT</b>						
Collector emitter leakage current	$V_{CE} = 10\text{ V}$	$I_{CEO}$		0.3	100	nA
Collector emitter capacitance	$V_{CE} = 5\text{ V}$ , $f = 1\text{ MHz}$	$C_{CE}$		2.8		pF
Collector emitter breakdown voltage	$I_C = 1\text{ mA}$	$BV_{CEO}$	80			V
Emitter collector breakdown voltage	$I_E = 100\text{ }\mu\text{A}$	$BV_{ECO}$	7			V
<b>COUPLER</b>						
Collector emitter saturation voltage	$I_F = 10\text{ mA}$ , $I_C = 2.5\text{ mA}$	$V_{CEsat}$		0.25	0.4	V
Coupling capacitance	$f = 1\text{ MHz}$	$C_C$		0.4		pF
Cut-off frequency	$I_F = 10\text{ mA}$ , $V_{CC} = 5\text{ V}$ , $R_L = 100\text{ }\Omega$	$f_{ctr}$		110		kHz

**Note**

- Minimum and maximum values are testing requirements. Typical values are characteristics of the device and are the result of engineering evaluation. Typical values are for information only and are not part of the testing requirements.

<b>CURRENT TRANSFER RATIO</b> ( $T_{amb} = 25\text{ }^{\circ}\text{C}$ , unless otherwise specified)							
PARAMETER	TEST CONDITION	PART	SYMBOL	MIN.	TYP.	MAX.	UNIT
$I_C/I_F$	$I_F = 10\text{ mA}$ , $V_{CE} = 5\text{ V}$	VO615C-1	CTR	40		80	%
		VO615C-2	CTR	63		125	%
		VO615C-3	CTR	100		200	%
		VO615C-4	CTR	160		320	%

<b>SWITCHING CHARACTERISTICS</b> ( $T_{amb} = 25\text{ }^{\circ}\text{C}$ , unless otherwise specified)						
PARAMETER	TEST CONDITION	SYMBOL	MIN.	TYP.	MAX.	UNIT
<b>NON-SATURATED</b>						
Rise time	$I_C = 2\text{ mA}$ , $V_{CC} = 5\text{ V}$ , $R_L = 100\text{ }\Omega$	$t_r$		3		$\mu\text{s}$
Fall time		$t_f$		3		$\mu\text{s}$
Turn-on time		$t_{on}$		6		$\mu\text{s}$
Turn-off time		$t_{off}$		4		$\mu\text{s}$

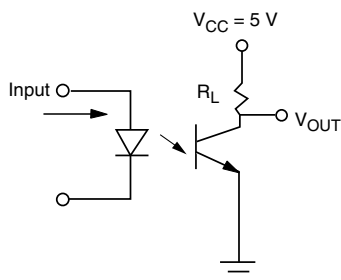


Fig. 3 - Test Circuit

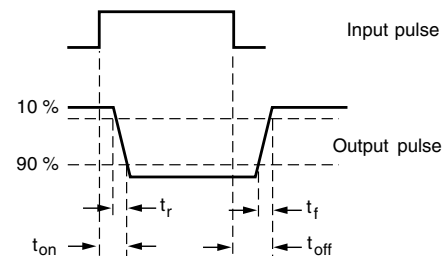


Fig. 4 - Test Circuit and Waveforms

SAFETY AND INSULATION RATINGS				
PARAMETER		SYMBOL	VALUE	UNIT
<b>MAXIMUM SAFETY RATINGS</b>				
Output safety power		$P_{SO}$	700	mW
Input safety current		$I_{si}$	400	mW
Safety temperature		$T_S$	175	°C
Comparative tracking index		CTI	175	
<b>INSULATION RATED PARAMETERS</b>				
Maximum withstanding isolation voltage		$V_{ISO}$	5300	$V_{RMS}$
Maximum transient isolation voltage		$V_{IOTM}$	8000	$V_{peak}$
Maximum repetitive peak isolation voltage		$V_{IORM}$	565	$V_{peak}$
		$V_{IORM}^{(1)}$	1140	$V_{peak}$
Insulation resistance		$T_{amb} = 25\text{ °C}, V_{DC} = 500\text{ V}$	$R_{IO}$	$\geq 10^{12}$
Isolation resistance		$T_{amb} = 100\text{ °C}, V_{DC} = 500\text{ V}$	$R_{IO}$	$\geq 10^{11}$
Climatic classification (according to IEC 68 part 1)				55/110/21
Environment (pollution degree in accordance to DIN VDE 0109)				2
Internal and external creepage		Standard DIP-4		$\geq 7$
		400 mil DIP-4		$\geq 8$
Clearance		Standard DIP-4		$\geq 7$
		400 mil DIP-4		$\geq 8$
Insulation thickness				0.4
				mm

**Notes**

- As per DIN EN 60747-5-5, 2, § 7.4.3.8.2, this optocoupler is suitable for “safe electrical insulation” only within the safety ratings. Compliance with the safety ratings shall be ensured by means of protective circuits.
- <sup>(1)</sup> Only for option 6.

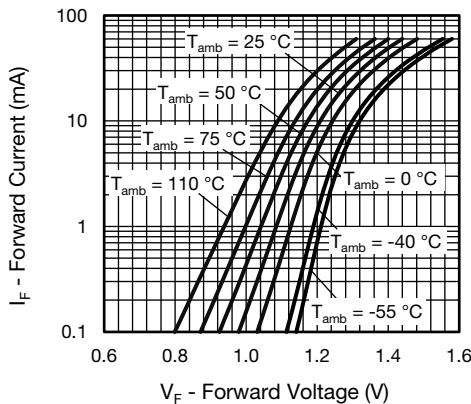
**TYPICAL CHARACTERISTICS** ( $T_{amb} = 25\text{ °C}$ , unless otherwise specified)


Fig. 5 - Forward Voltage vs. Forward Current

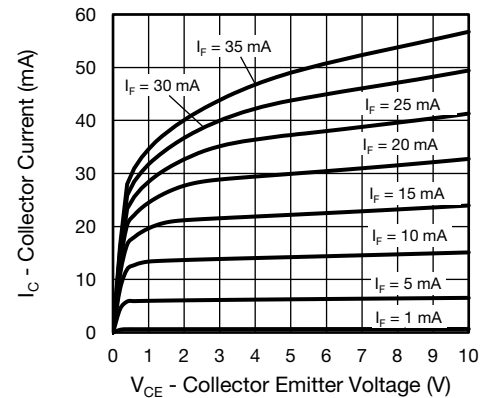


Fig. 6 - Collector Current vs. Collector Emitter Voltage (NS)

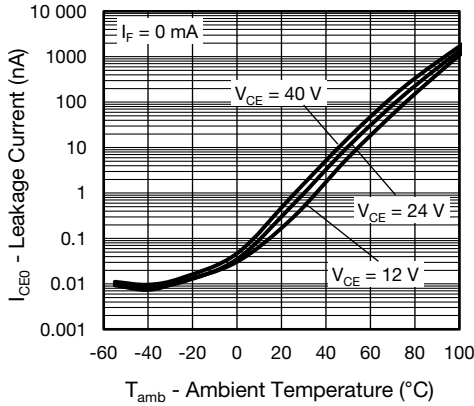


Fig. 7 - Leakage Current vs. Ambient Temperature

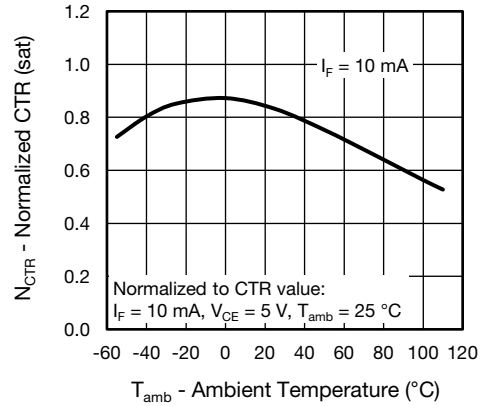


Fig. 10 - Normalized Current Transfer Ratio (saturated) vs. Ambient Temperature

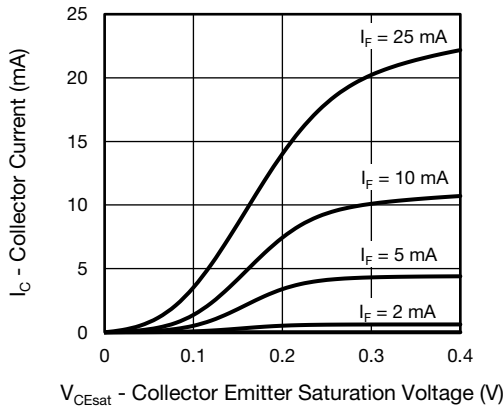


Fig. 8 - Collector Current vs. Collector Emitter Voltage (saturated)

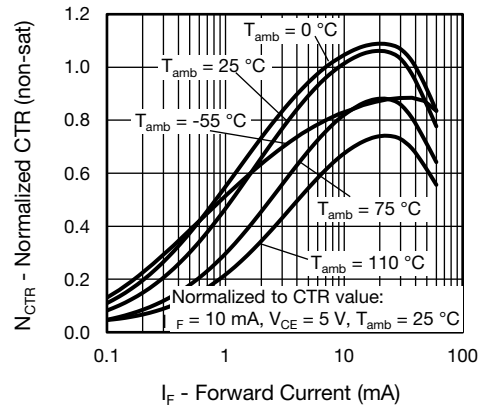


Fig. 11 - Normalized CTR (non-saturated) vs. Forward Current

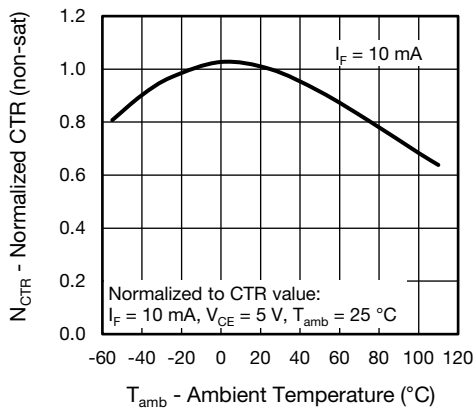


Fig. 9 - Normalized Current Transfer Ratio (non-saturated) vs. Ambient Temperature

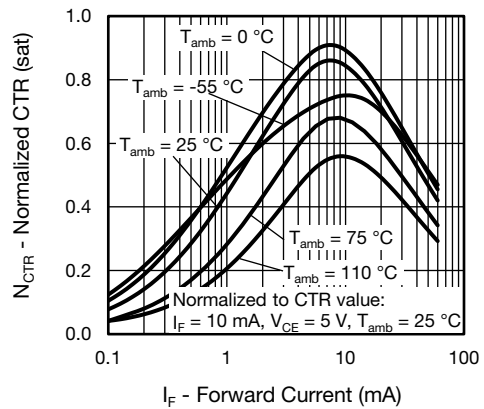


Fig. 12 - Normalized CTR (saturated) vs. Forward Current

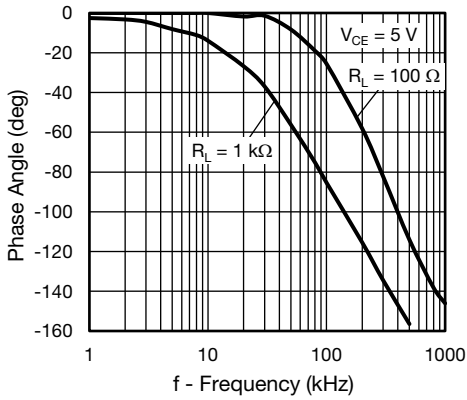


Fig. 13 - Phase Angle vs. Frequency

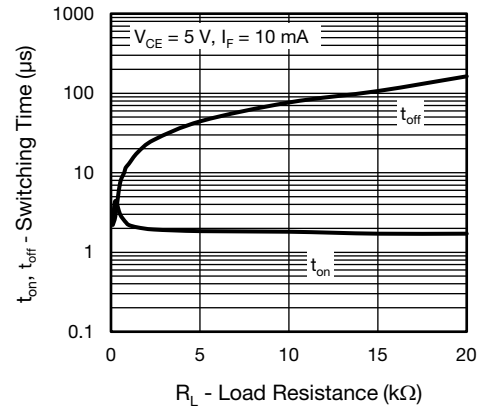


Fig. 15 - Switching Time vs. Load Resistance

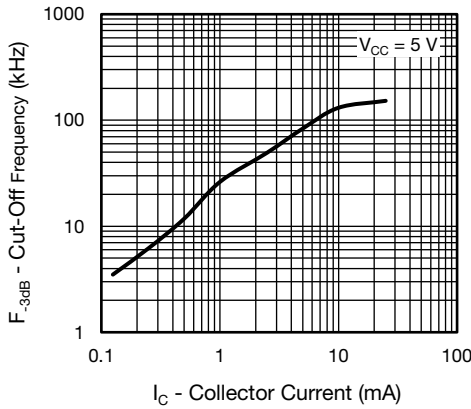


Fig. 14 - Frequency vs. Collector Current

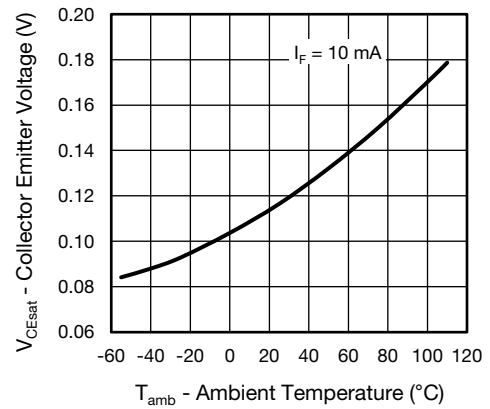
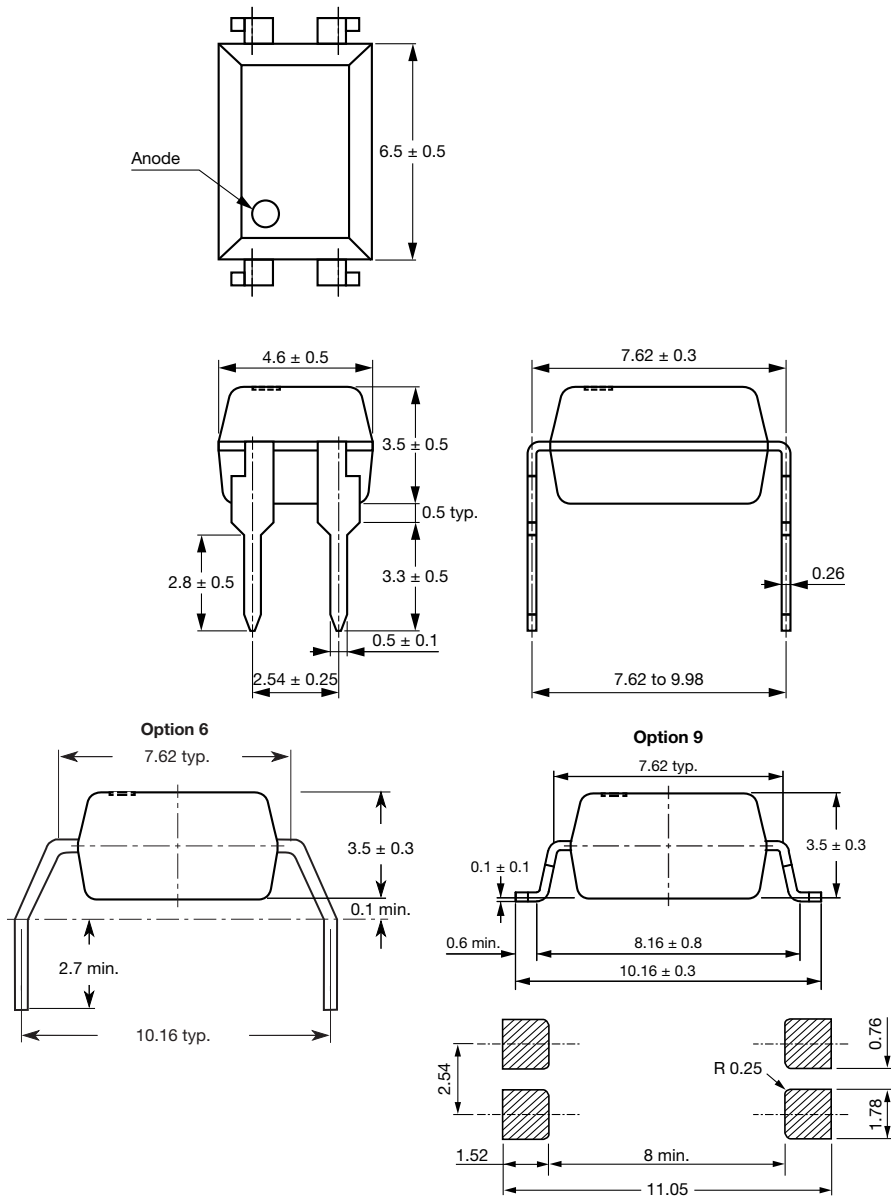
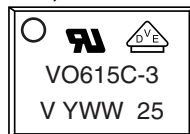


Fig. 16 - Collector Emitter Voltage vs. Ambient Temperature (saturated)

**PACKAGE DIMENSIONS** in millimeters



**PACKAGE MARKING** (Example of VO615C-3X016)



**Note**

- Option information is not marked.

**PACKING INFORMATION**

DEVICE PER TUBE			
TYPE	UNITS/TUBE	TUBES/BOX	UNITS/BOX
DIP-4	100	40	4000

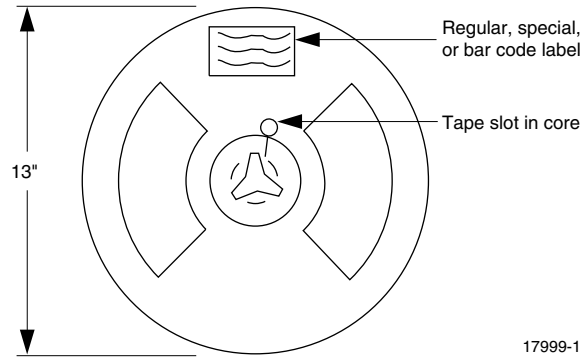


Fig. 17 - Tape and Reel Shipping Medium

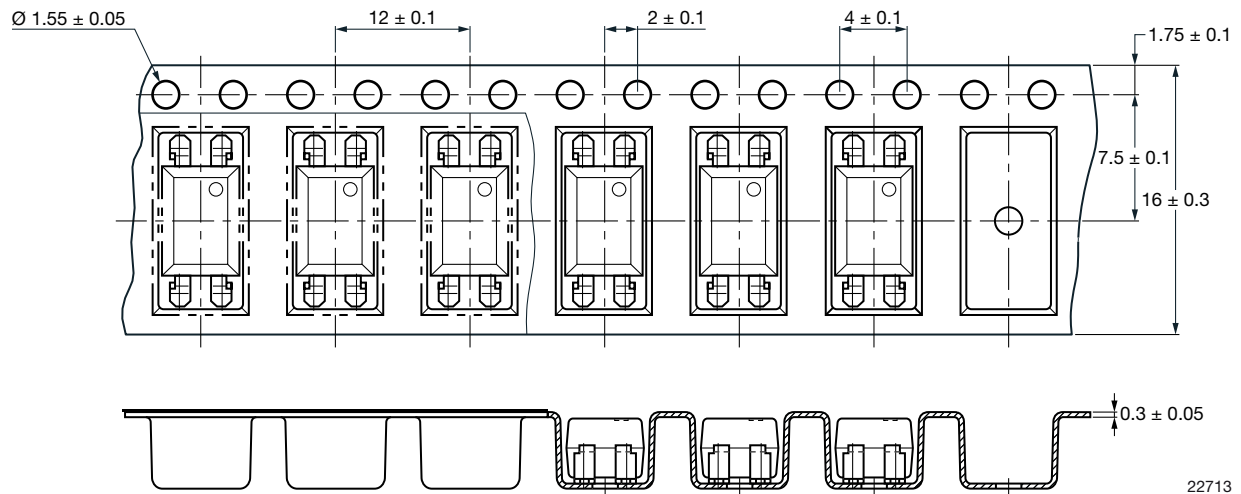


Fig. 18 - Tape Packing for Option 7 and 9, T1 rotation (2000 units per reel)





## Disclaimer

ALL PRODUCT, PRODUCT SPECIFICATIONS AND DATA ARE SUBJECT TO CHANGE WITHOUT NOTICE TO IMPROVE RELIABILITY, FUNCTION OR DESIGN OR OTHERWISE.

Vishay Intertechnology, Inc., its affiliates, agents, and employees, and all persons acting on its or their behalf (collectively, "Vishay"), disclaim any and all liability for any errors, inaccuracies or incompleteness contained in any datasheet or in any other disclosure relating to any product.

Vishay makes no warranty, representation or guarantee regarding the suitability of the products for any particular purpose or the continuing production of any product. To the maximum extent permitted by applicable law, Vishay disclaims (i) any and all liability arising out of the application or use of any product, (ii) any and all liability, including without limitation special, consequential or incidental damages, and (iii) any and all implied warranties, including warranties of fitness for particular purpose, non-infringement and merchantability.

Statements regarding the suitability of products for certain types of applications are based on Vishay's knowledge of typical requirements that are often placed on Vishay products in generic applications. Such statements are not binding statements about the suitability of products for a particular application. It is the customer's responsibility to validate that a particular product with the properties described in the product specification is suitable for use in a particular application. Parameters provided in datasheets and/or specifications may vary in different applications and performance may vary over time. All operating parameters, including typical parameters, must be validated for each customer application by the customer's technical experts. Product specifications do not expand or otherwise modify Vishay's terms and conditions of purchase, including but not limited to the warranty expressed therein.

Except as expressly indicated in writing, Vishay products are not designed for use in medical, life-saving, or life-sustaining applications or for any other application in which the failure of the Vishay product could result in personal injury or death. Customers using or selling Vishay products not expressly indicated for use in such applications do so at their own risk. Please contact authorized Vishay personnel to obtain written terms and conditions regarding products designed for such applications.

No license, express or implied, by estoppel or otherwise, to any intellectual property rights is granted by this document or by any conduct of Vishay. Product names and markings noted herein may be trademarks of their respective owners.

## Material Category Policy

**Vishay Intertechnology, Inc. hereby certifies that all its products that are identified as RoHS-Compliant fulfill the definitions and restrictions defined under Directive 2011/65/EU of The European Parliament and of the Council of June 8, 2011 on the restriction of the use of certain hazardous substances in electrical and electronic equipment (EEE) - recast, unless otherwise specified as non-compliant.**

**Please note that some Vishay documentation may still make reference to RoHS Directive 2002/95/EC. We confirm that all the products identified as being compliant to Directive 2002/95/EC conform to Directive 2011/65/EU.**

**Vishay Intertechnology, Inc. hereby certifies that all its products that are identified as Halogen-Free follow Halogen-Free requirements as per JEDEC JS709A standards. Please note that some Vishay documentation may still make reference to the IEC 61249-2-21 definition. We confirm that all the products identified as being compliant to IEC 61249-2-21 conform to JEDEC JS709A standards.**

## X-ON Electronics

Largest Supplier of Electrical and Electronic Components

*Click to view similar products for [Transistor Output Optocouplers](#) category:*

*Click to view products by [Vishay](#) manufacturer:*

Other Similar products are found below :

[LTV-814S-TA](#) [LTV-824HS](#) [66095-001](#) [6N136-X017T](#) [MCT6-X007](#) [MOC8101-X017T](#) [PS2561A-1-W-A](#) [PS2561B-1-L-A](#) [PS2561L-1-V-A](#)  
[MRF658](#) [IL755-1X007](#) [ILD2-X006](#) [ILD74-X001](#) [ILQ615-2X017](#) [ILQ615-3X016](#) [LDA102S](#) [LDA110S](#) [PS2561-1-V-W-A](#) [PS2561AL-1-V-](#)  
[A](#) [PS2561L1-1-L-A](#) [PS2701A-1-F3-P-A](#) [PS2801-1-F3-P-A](#) [PS2911-1-L-AX](#) [CNY17-2X017](#) [CNY17-4X001](#) [CNY17-4X017](#) [CNY17F-](#)  
[1X007](#) [CNY17F-2X017](#) [CNY17F-4X001](#) [CNY17G-1](#) [LTV-214](#) [LTV-702VB](#) [LTV-733S](#) [LTV-816S-TA](#) [LTV-825S](#) [TCET1113](#) [TCET2100](#)  
[4N25-X007T](#) [IL215AT](#) [ILD615-1X007](#) [ILQ2-X007](#) [VOS615A-2T](#) [WPPC-A11066AA](#) [WPPC-A11066AD](#) [WPPC-A11084ASS](#) [WPPC-](#)  
[A21068AA](#) [WPPC-D11066AA](#) [WPPC-D21068ED](#) [WPPC-D410616EA](#) [WPPC-D410616ED](#)