

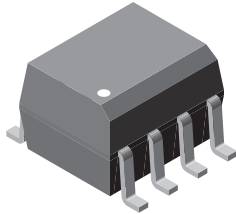

## Optocoupler, Phototransistor Output, Dual Channel, SOIC-8 Package

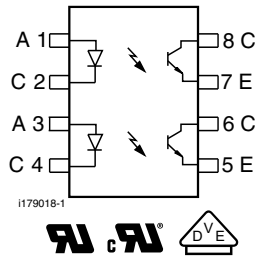

i179074



### FEATURES

- Two channel coupler
- SOIC-8 surface mountable package
- Standard lead spacing of 0.05"
- Available only on tape and reel option (conforms to EIA standard 481-2)
- Isolation test voltage, 4000 V<sub>RMS</sub>
- Compatible with dual wave, vapor phase and IR reflow soldering
- Material categorization: For definitions of compliance please see [www.vishay.com/doc?99912](http://www.vishay.com/doc?99912)



RoHS COMPLIANT

### DESCRIPTION

The VOD205T, VOD206T, VOD207T, VOD211T, VOD213T, VOD217T are optically coupled pairs with a gallium arsenide infrared LED and a silicon NPN phototransistor. Signal information, including a DC level, can be transmitted by the device while maintaining a high degree of electrical isolation between input and output.

### AGENCY APPROVALS

- UL1577, file no. E52744 system code Y
- cUL - file no. E52744, equivalent to CSA bulletin 5A
- DIN EN 60747-5-5 (VDE 0884-5) approved, contact customer service if this option is required

### ORDERING INFORMATION

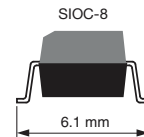
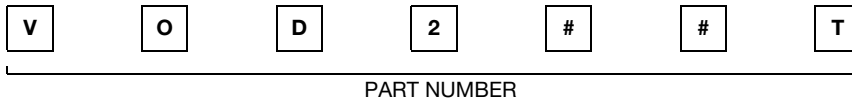

| AGENCY CERTIFIED/PACKAGE | CTR (%)  |           |            |         |                      |                      |
|--------------------------|----------|-----------|------------|---------|----------------------|----------------------|
| UL, cUL                  | 40 to 80 | 63 to 125 | 100 to 200 | > 20    | > 100 <sup>(1)</sup> | > 100 <sup>(2)</sup> |
| SOIC-8                   | VOD205T  | VOD206T   | VOD207T    | VOD211T | VOD213T              | VOD217T              |

#### Notes

- (1) I<sub>F</sub> = 10 mA  
 (2) I<sub>F</sub> = 1 mA

### ABSOLUTE MAXIMUM RATINGS (T<sub>amb</sub> = 25 °C, unless otherwise specified)

| PARAMETER                              | TEST CONDITION | SYMBOL            | VALUE | UNIT  |
|--|----------------|-------------------|-------|-------|
| <b>INPUT</b>                           |                |                   |       |       |
| Peak reverse voltage                   |                | V <sub>R</sub>    | 6     | V     |
| Peak pulsed current                    | 1 μs, 300 pps  | I <sub>FM</sub>   | 1     | A     |
| Continuous forward current per channel |                | I <sub>F</sub>    | 30    | mA    |
| Power dissipation                      |                | P <sub>diss</sub> | 50    | mW    |
| Derate linearly from 25 °C             |                |                   | 0.66  | mW/°C |
| <b>OUTPUT</b>                          |                |                   |       |       |
| Collector emitter breakdown voltage    |                | BV <sub>CEO</sub> | 70    | V     |
| Emitter collector breakdown voltage    |                | BV <sub>ECO</sub> | 7     | V     |
| Continuous output current              |                | I <sub>Cmax</sub> | 50    | mA    |
| Power dissipation per channel          |                | P <sub>diss</sub> | 125   | mW    |
| Derate linearly from 25 °C             |                |                   | 1.67  | mW/°C |



| ABSOLUTE MAXIMUM RATINGS ( $T_{amb} = 25\text{ }^{\circ}\text{C}$ , unless otherwise specified) |                  |           |             |           |
|---|------------------|-----------|-------------|-----------|
| PARAMETER   | TEST CONDITION   | SYMBOL    | VALUE       | UNIT      |
| <b>COUPLER</b>  |                  |           |             |           |
| Isolation test voltage  | $t = 1\text{ s}$ | $V_{ISO}$ | 4000        | $V_{RMS}$ |
| Total package dissipation ambient<br>(2 LEDs and 2 detectors, 2 channels)                       |                  | $P_{tot}$ | 300         | mW        |
| Derate linearly from 25 °C  |                  |           | 4           | mW/°C     |
| Storage temperature   |                  | $T_{stg}$ | -40 to +150 | °C        |
| Operating temperature   |                  | $T_{amb}$ | -40 to +100 | °C        |
| Soldering time from 260 °C <sup>(1)</sup>   |                  | $T_{sld}$ | 10          | s         |

**Notes**

- Stresses in excess of the absolute maximum ratings can cause permanent damage to the device. Functional operation of the device is not implied at these or any other conditions in excess of those given in the operational sections of this document. Exposure to absolute maximum ratings for extended periods of the time can adversely affect reliability.
- <sup>(1)</sup> Refer to reflow profile for soldering conditions for surface mounted devices.

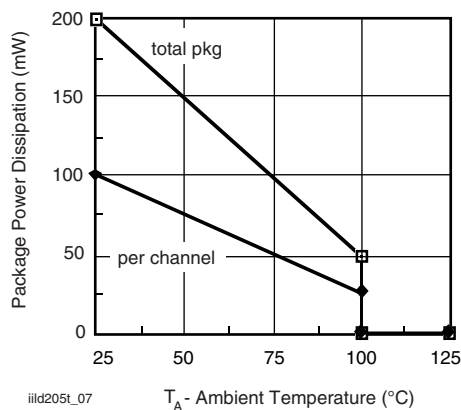

Fig. 1 - Power Dissipation vs. Ambient Temperature

| ELECTRICAL CHARACTERISTICS ( $T_{amb} = 25\text{ }^{\circ}\text{C}$ , unless otherwise specified) |   |      |             |      |      |      |               |
|---|---|------|-------------|------|------|------|---------------|
| PARAMETER   | TEST CONDITION                            | PART | SYMBOL      | MIN. | TYP. | MAX. | UNIT          |
| <b>INPUT</b>  |   |      |             |      |      |      |               |
| Forward voltage   | $I_F = 10\text{ mA}$                      |      | $V_F$       |      | 1.2  | 1.55 | V             |
| Reverse current   | $V_R = 6\text{ V}$                        |      | $I_R$       |      | 0.1  | 100  | $\mu\text{A}$ |
| Capacitance   | $V_R = 0\text{ V}$                        |      | $C_O$       |      | 25   |      | pF            |
| <b>OUTPUT</b>   |   |      |             |      |      |      |               |
| Collector emitter breakdown voltage   | $I_C = 100\text{ }\mu\text{A}$            |      | $BV_{CEO}$  | 70   |      |      | V             |
| Emitter collector breakdown voltage   | $I_E = 100\text{ }\mu\text{A}$            |      | $BV_{ECO}$  | 7    |      |      | V             |
| Collector emitter leakage current   | $V_{CE} = 10\text{ V}, I_F = 0\text{ A}$  |      | $I_{CEO}$   |      | 5    | 50   | nA            |
| Collector emitter capacitance   | $V_{CE} = 0\text{ V}$                     |      | $C_{CE}$    |      | 10   |      | pF            |
| Collector emitter saturation voltage  | $I_F = 10\text{ mA}, I_C = 2.5\text{ mA}$ |      | $V_{CEsat}$ |      |      | 0.4  | V             |
| <b>COUPLER</b>  |   |      |             |      |      |      |               |
| Capacitance (input to output)   |   |      | $C_{IO}$    |      | 0.5  |      | pF            |

**Note**

- Minimum and maximum values were tested requirements. Typical values are characteristics of the device and are the result of engineering evaluations. Typical values are for information only and are not part of the testing requirements.



| CURRENT TRANSFER RATIO |   |         |            |      |      |      |      |
|------------------------|---|---------|------------|------|------|------|------|
| PARAMETER              | TEST CONDITION                            | PART    | SYMBOL     | MIN. | TYP. | MAX. | UNIT |
| $I_C/I_F$              | $V_{CE} = 5\text{ V}, I_F = 10\text{ mA}$ | VOD205T | $CTR_{DC}$ | 40   |      | 80   | %    |
|                        |   | VOD206T | $CTR_{DC}$ | 63   |      | 125  | %    |
|                        |   | VOD207T | $CTR_{DC}$ | 100  |      | 200  | %    |
|                        |   | VOD211T | $CTR_{DC}$ | 20   |      |      | %    |
|                        |   | VOD213T | $CTR_{DC}$ | 100  |      |      | %    |
|                        | $V_{CE} = 5\text{ V}, I_F = 1\text{ mA}$  | VOD205T | $CTR_{DC}$ | 13   | 30   |      | %    |
|                        |   | VOD206T | $CTR_{DC}$ | 22   | 45   |      | %    |
|                        |   | VOD207T | $CTR_{DC}$ | 34   | 70   |      | %    |
| VOD217T                | $CTR_{DC}$                                | 100     | 120        |      | %    |      |      |

| SWITCHING CHARACTERISTICS |   |           |      |      |      |               |  |
|---------------------------|---|-----------|------|------|------|---------------|--|
| PARAMETER                 | TEST CONDITION  | SYMBOL    | MIN. | TYP. | MAX. | UNIT          |  |
| Turn-on time              | $I_C = 2\text{ mA}, R_L = 100\ \Omega, V_{CC} = 5\text{ V}$ | $t_{on}$  |      | 5    |      | $\mu\text{s}$ |  |
| Turn-off time             | $I_C = 2\text{ mA}, R_L = 100\ \Omega, V_{CC} = 5\text{ V}$ | $t_{off}$ |      | 4    |      | $\mu\text{s}$ |  |
| Rise time                 | $I_C = 2\text{ mA}, R_L = 100\ \Omega, V_{CC} = 5\text{ V}$ | $t_r$     |      | 5    |      | $\mu\text{s}$ |  |
| Fall time                 | $I_C = 2\text{ mA}, R_L = 100\ \Omega, V_{CC} = 5\text{ V}$ | $t_f$     |      | 4    |      | $\mu\text{s}$ |  |

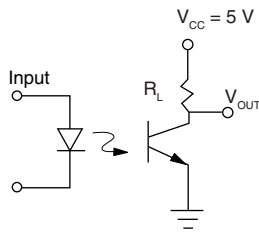

iii215at\_17

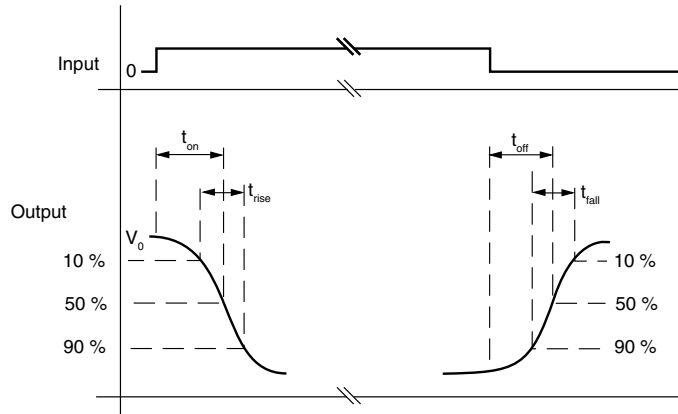

Fig. 2 - Switching Test Circuit

| COMMON MODE TRANSIENT IMMUNITY               |  |            |      |        |      |                        |  |
|--|--|------------|------|--------|------|------------------------|--|
| PARAMETER                                    | TEST CONDITION   | SYMBOL     | MIN. | TYP.   | MAX. | UNIT                   |  |
| Common mode transient immunity at logic high | $V_{CM} = 1000\text{ V}_{P-P}, R_L = 1\text{ k}\Omega, I_F = 0\text{ mA}$  | $ C_{MH} $ |      | 10 000 |      | $\text{V}/\mu\text{s}$ |  |
| Common mode transient immunity at logic low  | $V_{CM} = 1000\text{ V}_{P-P}, R_L = 1\text{ k}\Omega, I_F = 10\text{ mA}$ | $ C_{ML} $ |      | 10 000 |      | $\text{V}/\mu\text{s}$ |  |

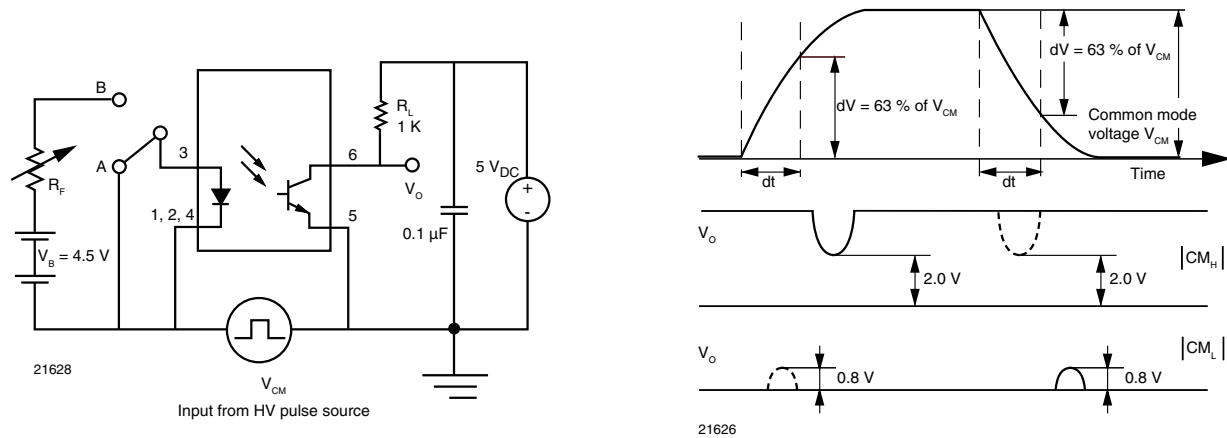

Fig. 3 - Test Circuit for Common Mode Transient Immunity

| SAFETY AND INSULATION RATINGS |                            |            |      |           |      |      |
|-------------------------------|----------------------------|------------|------|-----------|------|------|
| PARAMETER                     | TEST CONDITION             | SYMBOL     | MIN. | TYP.      | MAX. | UNIT |
| Climatic classification       | according to IEC 68 part 1 |            |      | 40/100/21 |      |      |
| Polution degree               |                            |            |      | 2         |      |      |
| Comparative tracking index    |                            | CTI        | 175  |           | 399  |      |
| Peak transient overvoltage    |                            | $V_{IOTM}$ | 6000 |           |      | V    |
| Peak insulation voltage       |                            | $V_{IORM}$ | 560  |           |      | V    |
| Resistance (input to output)  |                            | $R_{IO}$   |      | 100       |      | GΩ   |
| Apparent charge method a      |                            | $q_{pd}$   |      |           |      | C    |
| Apparent charge method b      |                            | $q_{pd}$   |      |           |      | C    |
| Safety rating - power output  |                            | $P_{SO}$   |      |           | 350  | mW   |
| Safety rating - input current |                            | $I_{SI}$   |      |           | 150  | mA   |
| Safety rating - temperature   |                            | $T_{SI}$   |      |           | 165  | °C   |
| External creepage distance    |                            |            | 4    |           |      | mm   |
| Internal creepage distance    |                            |            | 4    |           |      | mm   |
| External clearance distance   |                            |            | 4    |           |      | mm   |
| Insulation thickness          |                            |            | 0.2  |           |      | mm   |

**Note**

- As per IEC 60747-5-5, §7.4.3.8.2, this optocoupler is suitable for “safe electrical insulation” only within the safety ratings. Compliance with the safety ratings shall be ensured by means of protective circuits.



TYPICAL CHARACTERISTICS (T<sub>amb</sub> = 25 °C, unless otherwise specified)

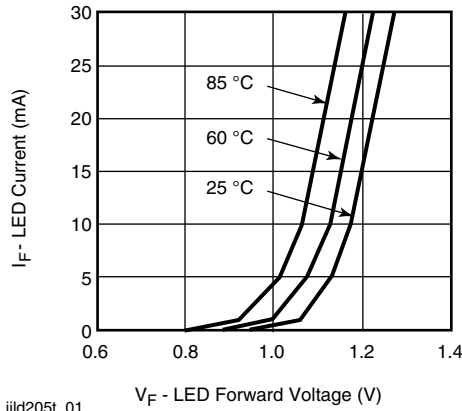

iiid205t\_01

Fig. 4 - Forward Current vs. Forward Voltage

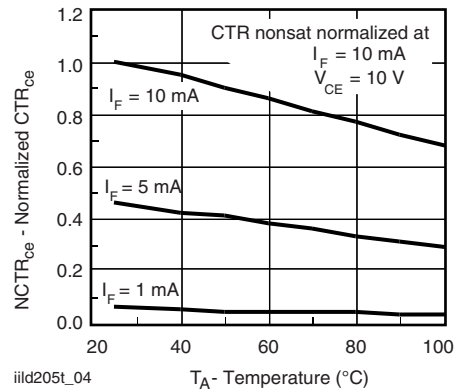

iiid205t\_04

Fig. 7 - Current Transfer Ratio (normalized) vs. Ambient Temperature

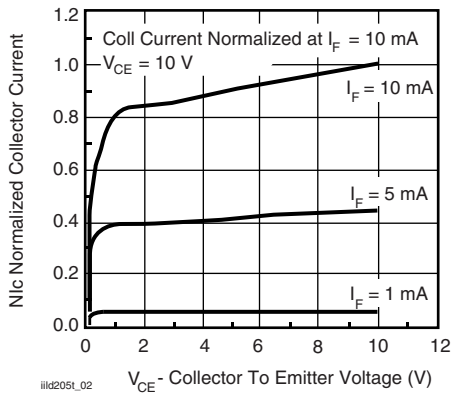

iiid205t\_02

Fig. 5 - Collector Emitter Current vs. V<sub>CE</sub>

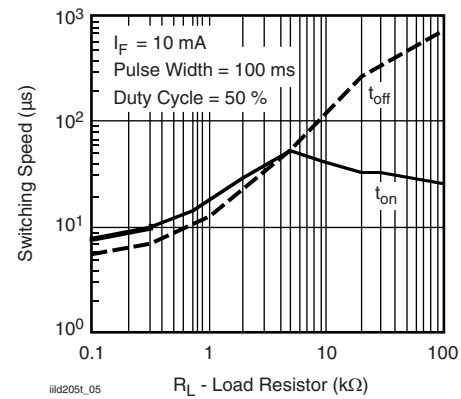

iiid205t\_05

Fig. 8 - Switching Speed vs. Load Resistor

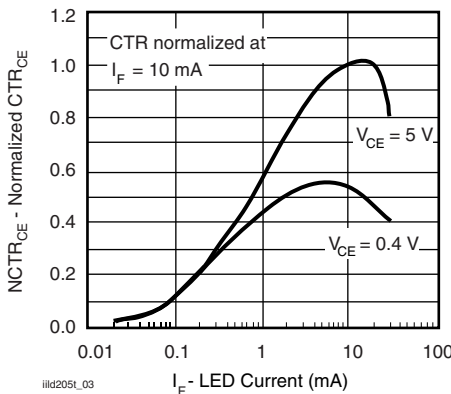

iiid205t\_03

Fig. 6 - Normalized CTR<sub>CE</sub> vs. Forward Current

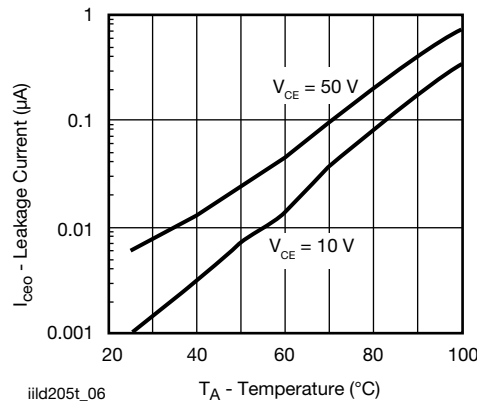

iiid205t\_06

Fig. 9 - Collector Current vs. Ambient Temperature



PACKAGE DIMENSIONS in millimeters

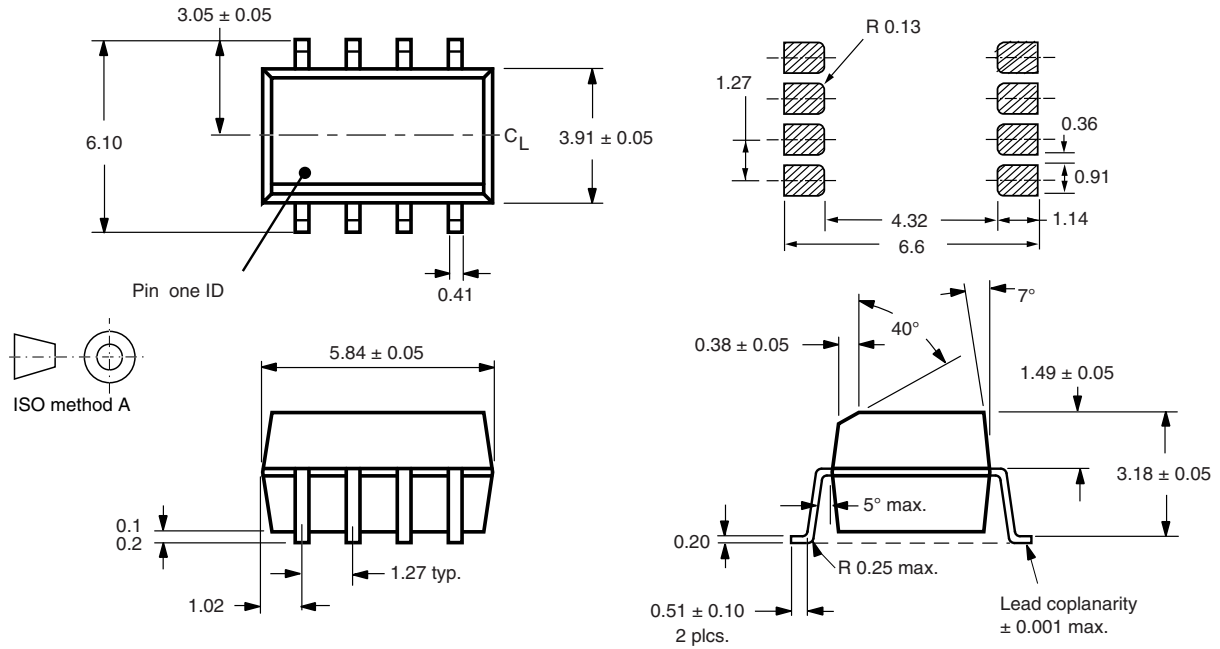

i178020

PACKAGE MARKING (example of VOD207T)

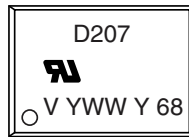

TAPE AND REEL PACKAGING

Dimensions in millimeters

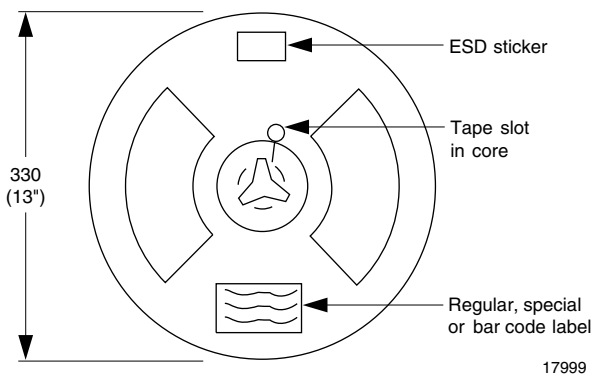

Fig. 10 - Tape and Reel Shipping Medium (EIA-481, revision A, and IEC 60286), 2000 units per reel

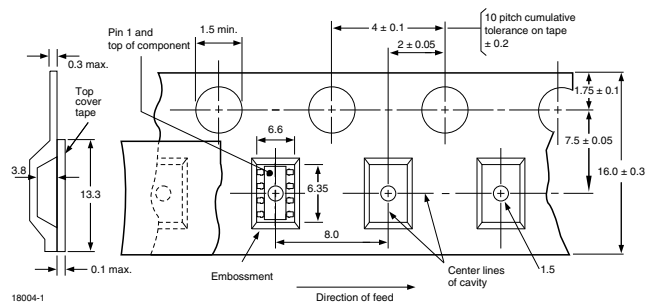

Fig. 11 - Tape Dimensions, 2000 Parts per Reel



## Footprint and Schematic Information for VOD205T, VOD206T, VOD207T, VOD211T, VOD213T, VOD217T

The footprint and schematic symbols for the following parts can be accessed using the associated links. They are available in Eagle, Altium, KiCad, OrCAD / Allegro, Pulsonix, and PADS.

Note that the 3D models for these parts can be found on the Vishay product page.

| PART NUMBER | FOOTPRINT / SCHEMATIC  |
|-------------|--|
| VOD205T     | <a href="http://www.snapeda.com/parts/VOD205T/Vishay/view-part">www.snapeda.com/parts/VOD205T/Vishay/view-part</a> |
| VOD206T     | <a href="http://www.snapeda.com/parts/VOD206T/Vishay/view-part">www.snapeda.com/parts/VOD206T/Vishay/view-part</a> |
| VOD207T     | <a href="http://www.snapeda.com/parts/VOD207T/Vishay/view-part">www.snapeda.com/parts/VOD207T/Vishay/view-part</a> |
| VOD211T     | <a href="http://www.snapeda.com/parts/VOD211T/Vishay/view-part">www.snapeda.com/parts/VOD211T/Vishay/view-part</a> |
| VOD213T     | <a href="http://www.snapeda.com/parts/VOD213T/Vishay/view-part">www.snapeda.com/parts/VOD213T/Vishay/view-part</a> |
| VOD217T     | <a href="http://www.snapeda.com/parts/VOD217T/Vishay/view-part">www.snapeda.com/parts/VOD217T/Vishay/view-part</a> |

For technical issues and product support, please contact [optocoupleranswers@vishay.com](mailto:optocoupleranswers@vishay.com).

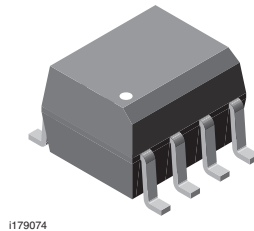



## **Disclaimer**

ALL PRODUCT, PRODUCT SPECIFICATIONS AND DATA ARE SUBJECT TO CHANGE WITHOUT NOTICE TO IMPROVE RELIABILITY, FUNCTION OR DESIGN OR OTHERWISE.

Vishay Intertechnology, Inc., its affiliates, agents, and employees, and all persons acting on its or their behalf (collectively, "Vishay"), disclaim any and all liability for any errors, inaccuracies or incompleteness contained in any datasheet or in any other disclosure relating to any product.

Vishay makes no warranty, representation or guarantee regarding the suitability of the products for any particular purpose or the continuing production of any product. To the maximum extent permitted by applicable law, Vishay disclaims (i) any and all liability arising out of the application or use of any product, (ii) any and all liability, including without limitation special, consequential or incidental damages, and (iii) any and all implied warranties, including warranties of fitness for particular purpose, non-infringement and merchantability.

Statements regarding the suitability of products for certain types of applications are based on Vishay's knowledge of typical requirements that are often placed on Vishay products in generic applications. Such statements are not binding statements about the suitability of products for a particular application. It is the customer's responsibility to validate that a particular product with the properties described in the product specification is suitable for use in a particular application. Parameters provided in datasheets and / or specifications may vary in different applications and performance may vary over time. All operating parameters, including typical parameters, must be validated for each customer application by the customer's technical experts. Product specifications do not expand or otherwise modify Vishay's terms and conditions of purchase, including but not limited to the warranty expressed therein.

Except as expressly indicated in writing, Vishay products are not designed for use in medical, life-saving, or life-sustaining applications or for any other application in which the failure of the Vishay product could result in personal injury or death. Customers using or selling Vishay products not expressly indicated for use in such applications do so at their own risk. Please contact authorized Vishay personnel to obtain written terms and conditions regarding products designed for such applications.

No license, express or implied, by estoppel or otherwise, to any intellectual property rights is granted by this document or by any conduct of Vishay. Product names and markings noted herein may be trademarks of their respective owners.



## X-ON Electronics

Largest Supplier of Electrical and Electronic Components

*Click to view similar products for [Transistor Output Optocouplers](#) category:*

*Click to view products by [Vishay](#) manufacturer:*

Other Similar products are found below :

[LTV-814S-TA](#) [LTV-824HS](#) [66095-001](#) [6N136-X017T](#) [MCT6-X007](#) [MOC8101-X017T](#) [PS2561A-1-W-A](#) [PS2561B-1-L-A](#) [PS2561L-1-V-A](#)  
[MRF658](#) [IL755-1X007](#) [ILD2-X006](#) [ILD74-X001](#) [ILQ615-2X017](#) [ILQ615-3X016](#) [LDA102S](#) [LDA110S](#) [PS2561-1-V-W-A](#) [PS2561AL-1-V-](#)  
[A](#) [PS2561L1-1-L-A](#) [PS2701A-1-F3-P-A](#) [PS2801-1-F3-P-A](#) [PS2911-1-L-AX](#) [CNY17-2X017](#) [CNY17-4X001](#) [CNY17-4X017](#) [CNY17F-](#)  
[1X007](#) [CNY17F-2X017](#) [CNY17F-4X001](#) [CNY17G-1](#) [LTV-214](#) [LTV-702VB](#) [LTV-733S](#) [LTV-816S-TA](#) [LTV-825S](#) [TCET1113](#) [TCET2100](#)  
[4N25-X007T](#) [IL215AT](#) [ILD615-1X007](#) [ILQ2-X007](#) [VOS615A-2T](#) [WPPC-A11066AA](#) [WPPC-A11066AD](#) [WPPC-A11084ASS](#) [WPPC-](#)  
[A21068AA](#) [WPPC-D11066AA](#) [WPPC-D21068ED](#) [WPPC-D410616EA](#) [WPPC-D410616ED](#)