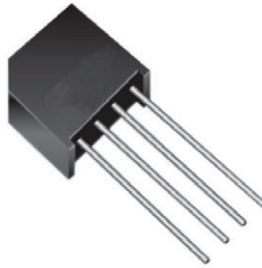

## Single Phase Rectifier Bridge, 1.9 A

**2KBB**

### FEATURES

- Suitable for printed circuit board mounting
- Leads on standard 2.54 mm (0.1") grid
- Compact construction
- High surge current capability
- Polarized package
- Equivalent to standard DIN parts
- Material categorization: for definitions of compliance please see [www.vishay.com/doc?99912](http://www.vishay.com/doc?99912)

**RoHS**  
COMPLIANT

### PRIMARY CHARACTERISTICS

$I_O$	1.9 A
$V_{RRM}$	50 V to 1000 V
Package	2KBB
Circuit configuration	Single phase bridge

### DESCRIPTION

A 1.9 A single phase diode bridge rectifier assembly consisting of four silicon diodes in a plastic encapsulation, intended for general applications in industrial and consumer equipment.

### MAJOR RATINGS AND CHARACTERISTICS

SYMBOL	CHARACTERISTICS	VALUES	UNITS
$I_O$		1.9	A
	$T_C$	45	°C
$I_{FSM}$	50 Hz	50	A
	60 Hz	52	
$I^2t$	50 Hz	17.7	A <sup>2</sup> s
	60 Hz	16.1	
$V_{RRM}$		100 to 1000	V
$T_J$		-40 to 150	°C

### ELECTRICAL SPECIFICATIONS

#### VOLTAGE RATINGS AND APPLICATION DATA

CROSS REFERENCE		$V_{RRM}, V_{RSM}$ MAXIMUM PEAK REVERSE VOLTAGE $T_J = 15\text{ °C}$ (V)	$I_{RM}$ TYPICAL PEAK REVERSE CURRENT PER DIODE AT RATED $V_{RRM}$ ( $\mu$ A)		APPLICATION DATA (SEE FIGURE 3)		
PART NUMBER	DIN CODE		$T_J = 25\text{ °C}$	$T_J = 150\text{ °C}$	$V_{RMS}$ MAXIMUM RECOMMENDE D AC SUPPLY VOLTAGE (V)	$C_{MAX}$ MAXIMUM LOAD CAPACITANCE ( $\mu$ F)	$R_{MIN}$ MINIMUM SOURCE RESISTANCE ( $\Omega$ )
VS-2KBB05	B20C1500	50	10	500	20	7000	0.3
VS-2KBB10	B40C1500	100	10	500	40	5000	0.5
VS-2KBB20	B80C1500	200	10	500	80	3300	0.8
VS-2KBB40	B125C1500	400	10	500	125	1600	1.5
VS-2KBB60	B250C1500	600	10	500	250	1200	2.5
VS-2KBB80	B380C1500	800	10	500	380	800	3.0
VS-2KBB100	B500C1500	1000	10	500	500	600	5.0

#### Note

- For PIN configuration - ~ ~ + add "R" to end of part number, e.g. 2KBB05R (see also dimensions for details - link at the end of datasheet)



FORWARD CONDUCTION					
PARAMETER	SYMBOL	TEST CONDITIONS		VALUES	UNITS
Maximum DC output current	$I_O$	$T_C = 45\text{ }^\circ\text{C}$ , resistive and inductive load		1.9	A
		$T_C = 45\text{ }^\circ\text{C}$ , capacitive load		1.5	
Maximum peak one cycle, non-repetitive surge current	$I_{FSM}$	t = 6 ms	Following any rated load condition, and with rated $V_{RRM}$ applied following surge	50	A
		t = 5 ms		52	
Maximum $I^2t$ for fusing, initial $T_J = T_J$ maximum	$I^2t$	t = 10 ms	Rated $V_{RRM}$ applied following surge, initial $T_J = 150\text{ }^\circ\text{C}$	12.5	$\text{A}^2\text{s}$
		t = 8.3 ms		11.3	
		t = 10 ms		17.7	
		t = 8.3 ms		16.1	
Maximum $I^2\sqrt{t}$ capability for fusing	$I^2\sqrt{t}$ (1)	t = 0.1 to 10 ms, $V_{RRM}$ following surge = 0		177	$\text{A}^2\sqrt{\text{s}}$
Maximum peak forward voltage per diode	$V_{FM}$	$I_O = 1.9\text{ A}$ (3.0 $A_{pk}$ )		1.1	V
Operating frequency range	f			40 to 2000	Hz

**Note**

(1)  $I^2t$  for time  $t_x = I^2\sqrt{t} \times \sqrt{t_x}$

THERMAL AND MECHANICAL SPECIFICATIONS			
PARAMETER	SYMBOL	VALUES	UNITS
Operating junction and storage temperature range	$T_J, T_{Stg}$	-40 to 150	$^\circ\text{C}$
Approximate weight		4	g
		0.14	oz.

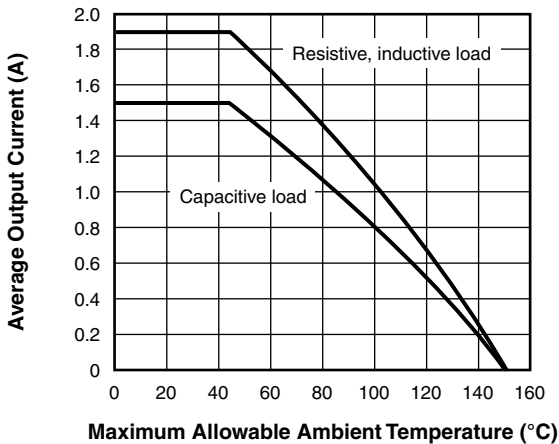

Fig. 1 - Average (DC) Output Current vs. Maximum Allowable Ambient Temperature

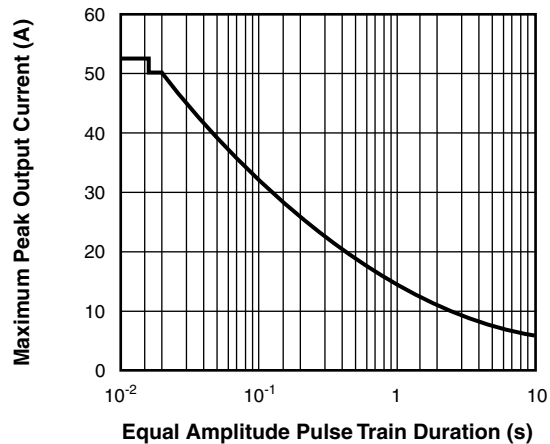

Fig. 2 - Maximum Non-Repetitive Surge Current vs. Pulse Train Duration (f = 50 Hz)

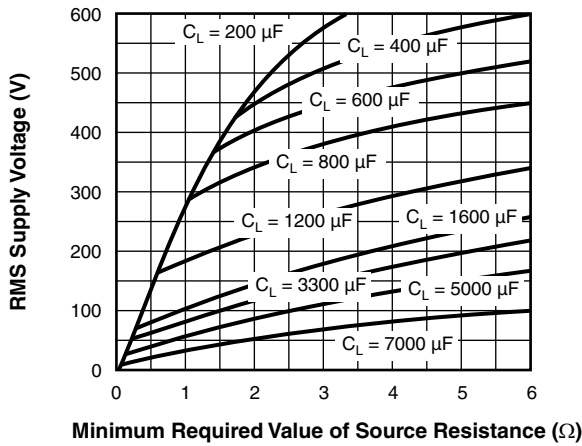

Fig. 3 - Minimum Required Source Resistance vs. RMS Supply Voltage and Load Capacitance

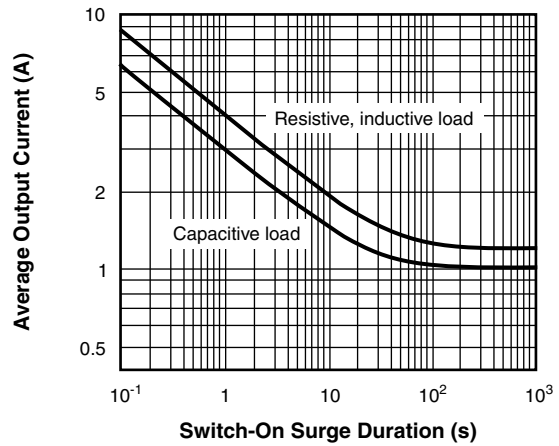
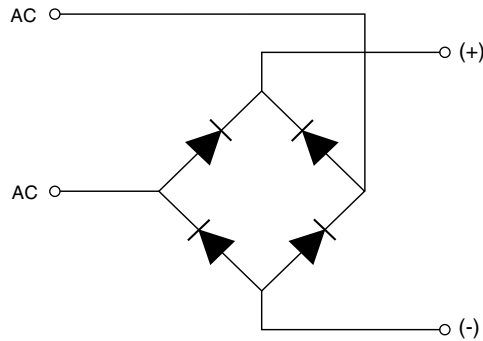

Fig. 4 - Maximum Switch-On Surge Current vs. Surge Duration

**CIRCUIT CONFIGURATION**



LINKS TO RELATED DOCUMENTS	
Dimensions	<a href="http://www.vishay.com/doc?95328">www.vishay.com/doc?95328</a>

## 2KBB

**DIMENSIONS** in millimeters (inches)

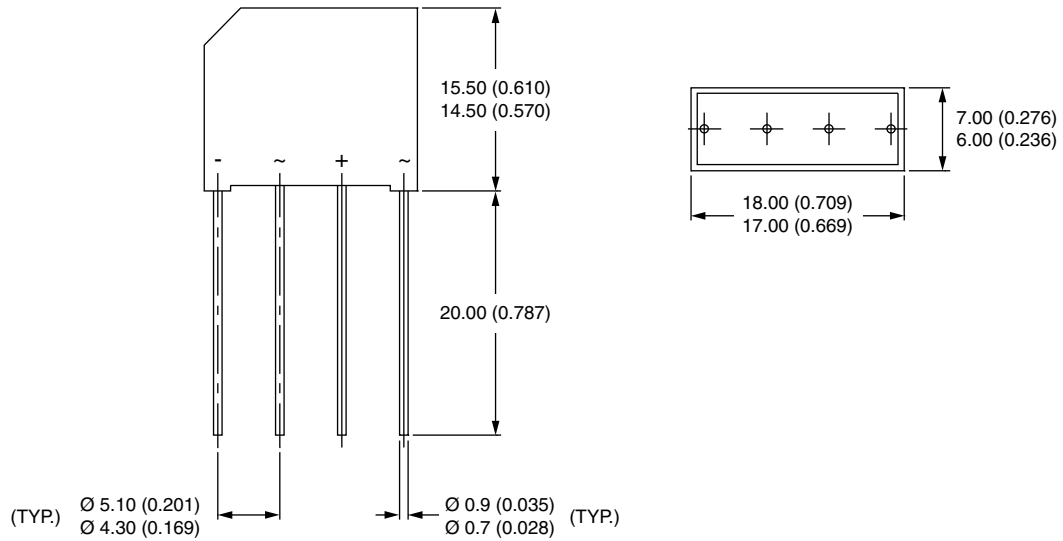

**Note**

- For PIN configuration - ~ ~ + add "R" to end of part number



## **Disclaimer**

ALL PRODUCT, PRODUCT SPECIFICATIONS AND DATA ARE SUBJECT TO CHANGE WITHOUT NOTICE TO IMPROVE RELIABILITY, FUNCTION OR DESIGN OR OTHERWISE.

Vishay Intertechnology, Inc., its affiliates, agents, and employees, and all persons acting on its or their behalf (collectively, "Vishay"), disclaim any and all liability for any errors, inaccuracies or incompleteness contained in any datasheet or in any other disclosure relating to any product.

Vishay makes no warranty, representation or guarantee regarding the suitability of the products for any particular purpose or the continuing production of any product. To the maximum extent permitted by applicable law, Vishay disclaims (i) any and all liability arising out of the application or use of any product, (ii) any and all liability, including without limitation special, consequential or incidental damages, and (iii) any and all implied warranties, including warranties of fitness for particular purpose, non-infringement and merchantability.

Statements regarding the suitability of products for certain types of applications are based on Vishay's knowledge of typical requirements that are often placed on Vishay products in generic applications. Such statements are not binding statements about the suitability of products for a particular application. It is the customer's responsibility to validate that a particular product with the properties described in the product specification is suitable for use in a particular application. Parameters provided in datasheets and / or specifications may vary in different applications and performance may vary over time. All operating parameters, including typical parameters, must be validated for each customer application by the customer's technical experts. Product specifications do not expand or otherwise modify Vishay's terms and conditions of purchase, including but not limited to the warranty expressed therein.

Except as expressly indicated in writing, Vishay products are not designed for use in medical, life-saving, or life-sustaining applications or for any other application in which the failure of the Vishay product could result in personal injury or death. Customers using or selling Vishay products not expressly indicated for use in such applications do so at their own risk. Please contact authorized Vishay personnel to obtain written terms and conditions regarding products designed for such applications.

No license, express or implied, by estoppel or otherwise, to any intellectual property rights is granted by this document or by any conduct of Vishay. Product names and markings noted herein may be trademarks of their respective owners.

## X-ON Electronics

Largest Supplier of Electrical and Electronic Components

*Click to view similar products for [Bridge Rectifiers](#) category:*

*Click to view products by [Vishay](#) manufacturer:*

Other Similar products are found below :

[MB2510](#) [MB252](#) [MB356G](#) [MB358G](#) [90MT160KPBF](#) [GBJ1504-BP](#) [GBU15J-BP](#) [GBU15K-BP](#) [GBU4A-BP](#) [GBU4D-BP](#) [GBU6B-E3/45](#)  
[GSIB680-E3/45](#) [DB101-BP](#) [DF01](#) [DF10SA-E345](#) [KBPC50-10S](#) [RS405GL-BP](#) [G5SBA60-E3/51](#) [GBU10J-BP](#) [GBU6M](#) [GBU8D-BP](#)  
[GBU8J-BP](#) [GSIB1520-E3/45](#) [2KBB10](#) [36MB140A](#) [TB102M](#) [MB1510](#) [MB258](#) [MB6M-G](#) [MB86](#) [TL401G](#) [MDA920A2](#) [TU602](#) [TU810](#)  
[BR1005-BP](#) [BR101-BP](#) [BR84DTP204](#) [BU2008-E3/51](#) [36MB100A](#) [KBPC10/15/2501WP](#) [KBPC25-02](#) [VS-2KBB60](#) [DF06SA-E345](#)  
[DF1510S](#) [VS-40MT160PAPBF](#) [W02M](#) [GBL02-E3/45](#) [GBU4G-BP](#) [GBJ2506-BP](#) [GBU6B-E3/51](#)