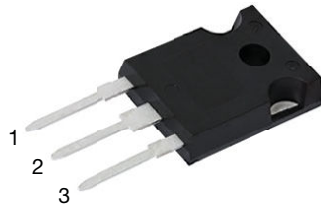
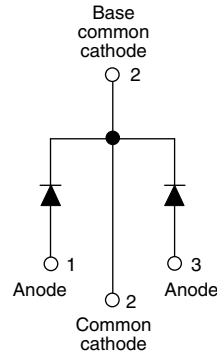

High Performance Schottky Rectifier, 2 x 20 A

TO-247AC 3L

FEATURES

- 150 °C T_J operation
- High purity, high temperature epoxy encapsulation for enhanced mechanical strength and moisture resistance
- Very low forward voltage drop
- High frequency operation
- Guard ring for enhanced ruggedness and long term reliability
- Designed and qualified according to JEDEC®-JESD 47
- Material categorization: for definitions of compliance please see www.vishay.com/doc?99912

RoHS
 COMPLIANT
 HALOGEN
FREE

DESCRIPTION

The VS-40L...CW... center tap Schottky rectifier has been optimized for very low forward voltage drop with moderate leakage. The proprietary barrier technology allows for reliable operation up to 150 °C junction temperature. Typical applications are in parallel switching power supplies.

PRIMARY CHARACTERISTICS

$I_{F(AV)}$	2 x 20 A
V_R	40 V, 45 V
V_F at I_F	0.49 V
I_{RM} max.	80 mA at 100 °C
T_J max.	150 °C
E_{AS}	20 mJ
Package	TO-247AC 3L
Circuit configuration	Common cathode

MAJOR RATINGS AND CHARACTERISTICS

SYMBOL	CHARACTERISTICS	VALUES	UNITS
$I_{F(AV)}$	Rectangular waveform	40	A
V_{RRM}		40/45	V
I_{FSM}	$t_p = 5 \mu s$ sine	1240	A
V_F	20 A _{pk} , $T_J = 125$ °C (per leg, typical)	0.42	V
T_J		-55 to +150	°C

VOLTAGE RATINGS

PARAMETER	SYMBOL	VS-40L40CW-N3	VS-40L45CW-N3	UNITS
Maximum DC reverse voltage	V_R	40	45	V
Maximum working peak reverse voltage	V_{RWM}			

ABSOLUTE MAXIMUM RATINGS

PARAMETER	SYMBOL	TEST CONDITIONS	VALUES	UNITS
Maximum average forward current, see fig. 5	$I_{F(AV)}$	50 % duty cycle at $T_C = 122$ °C, rectangular waveform	20	A
			40	
Maximum peak one cycle non-repetitive surge current per leg, see fig. 7	I_{FSM}	5 μs sine or 3 μs rect. pulse	1240	A
		10 ms sine or 6 ms rect. pulse	350	
Non-repetitive avalanche energy per leg	E_{AS}	$T_J = 25$ °C, $I_{AS} = 3$ A, $L = 4.4$ mH	20	mJ
Repetitive avalanche current per leg	I_{AR}	Current decaying linearly to zero in 1 μs Frequency limited by T_J maximum $V_A = 1.5 \times V_R$ typical	3	A



ELECTRICAL SPECIFICATIONS						
PARAMETER	SYMBOL	TEST CONDITIONS		TYP.	MAX.	UNITS
Maximum forward voltage drop per leg See fig. 1	$V_{FM}^{(1)}$	20 A	$T_J = 25\text{ }^\circ\text{C}$	0.48	0.53	V
		40 A		0.61	0.69	
		20 A	$T_J = 125\text{ }^\circ\text{C}$	0.42	0.49	
		40 A		0.60	0.70	
Reverse leakage current per leg See fig. 2	$I_{RM}^{(1)}$	$T_J = 25\text{ }^\circ\text{C}$	$V_R = \text{Rated } V_R$	-	1.5	mA
		$T_J = 100\text{ }^\circ\text{C}$		20	80	
Threshold voltage	$V_{F(TO)}$	$T_J = T_J \text{ maximum}$		0.27		V
Forward slope resistance	r_t			8.72		$\text{m}\Omega$
Maximum junction capacitance per leg	C_T	$V_R = 5 V_{DC}$ (test signal range 100 kHz to 1 MHz) $25\text{ }^\circ\text{C}$		-	1500	pF
Maximum voltage rate of change	dV/dt	Rated V_R		10 000		$\text{V}/\mu\text{s}$

Note(1) Pulse width < 300 μs , duty cycle < 2 %

THERMAL - MECHANICAL SPECIFICATIONS				
PARAMETER	SYMBOL	TEST CONDITIONS	VALUES	UNITS
Maximum junction and storage temperature range	T_J, T_{Stg}		-55 to 150	$^\circ\text{C}$
Maximum thermal resistance, junction to case per leg	R_{thJC}	DC operation See fig. 4	1.6	$^\circ\text{C}/\text{W}$
Maximum thermal resistance, junction to case per package		DC operation	0.8	
Typical thermal resistance, case to heatsink	R_{thCS}	Mounting surface, smooth and greased	0.24	
Approximate weight			6	g
			0.21	oz.
Mounting torque	minimum	Non-lubricated threads	6 (5)	$\text{kgf} \cdot \text{cm}$ ($\text{lbf} \cdot \text{in}$)
	maximum		12 (10)	
Marking device		Case style TO-247AC 3L	40L40CW	
			40L45CW	

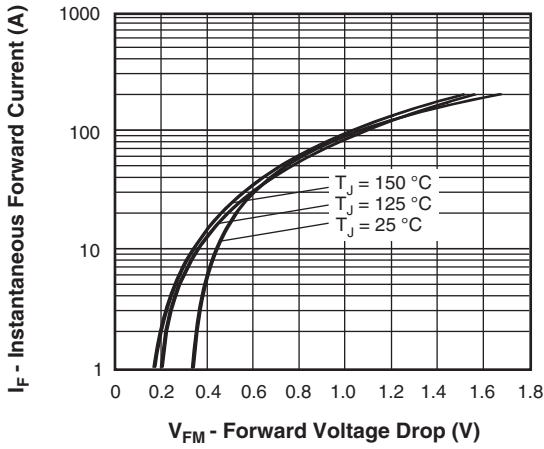

Fig. 1 - Maximum Forward Voltage Drop Characteristics (Per Leg)

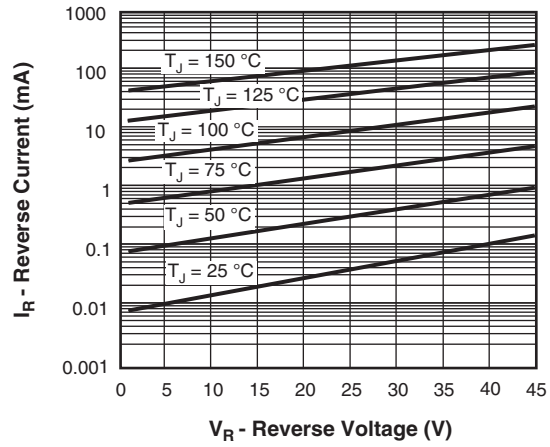

Fig. 2 - Typical Values of Reverse Current vs. Reverse Voltage (Per Leg)

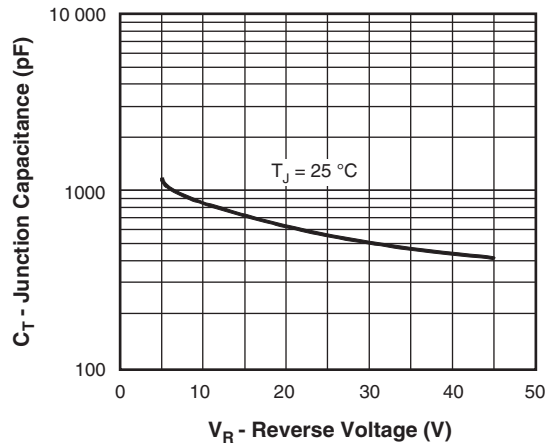

Fig. 3 - Typical Junction Capacitance vs. Reverse Voltage (Per Leg)

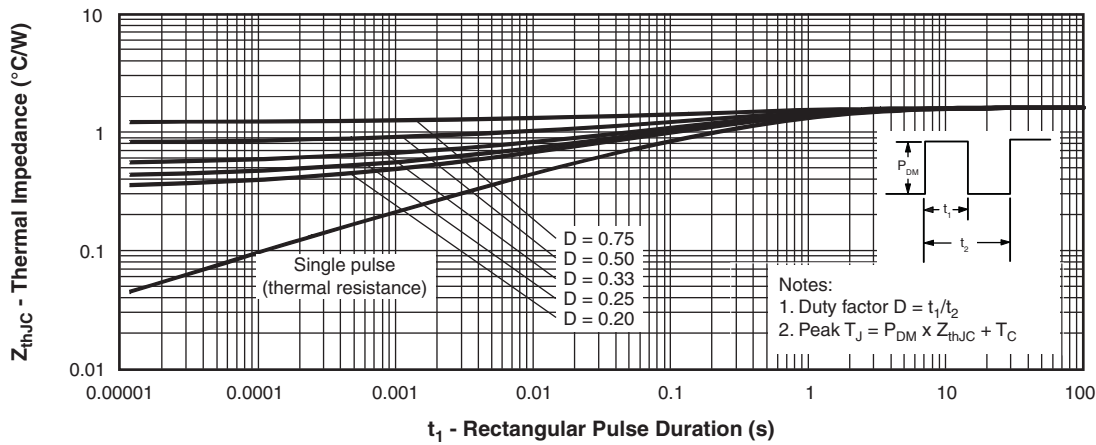

Fig. 4 - Maximum Thermal Impedance Z_{thJC} Characteristics (Per Leg)

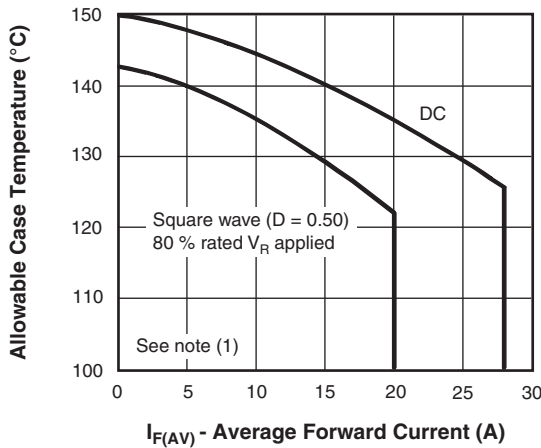

Fig. 5 - Maximum Allowable Case Temperature vs. Average Forward Current (Per Leg)

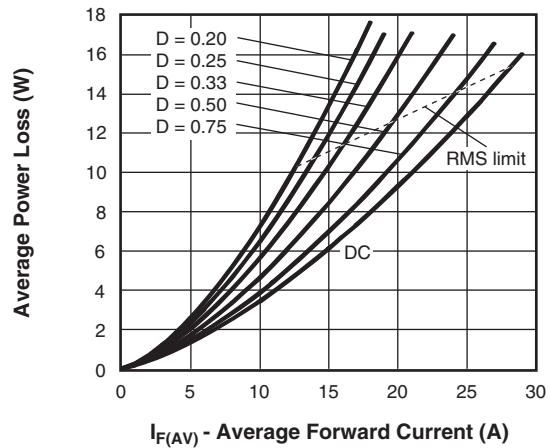

Fig. 6 - Forward Power Loss Characteristics (Per Leg)

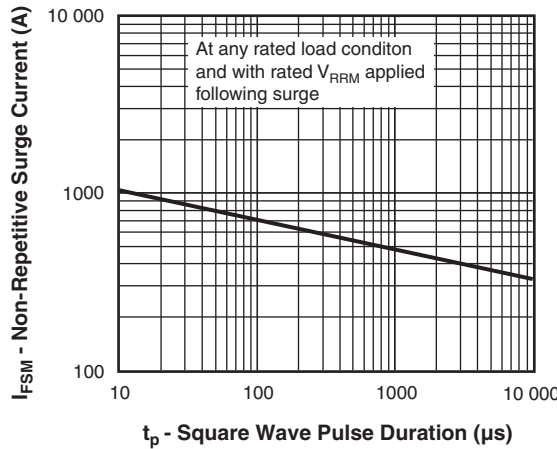

Fig. 7 - Maximum Non-Repetitive Surge Current (Per Leg)

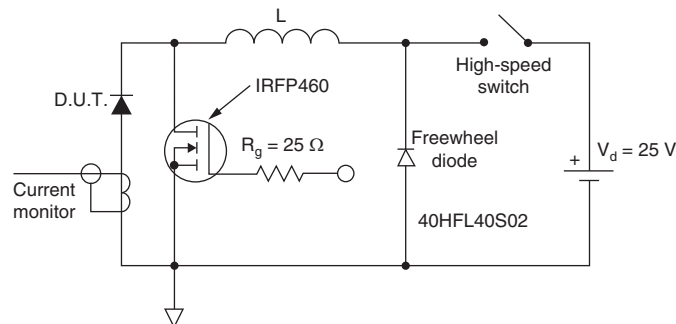

Fig. 8 - Unclamped Inductive Test Circuit

Note

- (1) Formula used: $T_C = T_J - (P_d + P_{d_{REV}}) \times R_{thJC}$;
 P_d = forward power loss = $I_{F(AV)} \times V_{FM}$ at $(I_{F(AV)}/D)$ (see fig. 6);
 $P_{d_{REV}}$ = inverse power loss = $V_{R1} \times I_R (1 - D)$; I_R at $V_{R1} = 80\%$ rated V_R



ORDERING INFORMATION TABLE

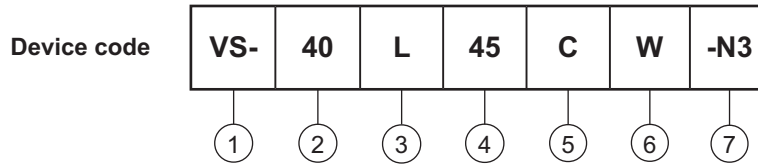

- 1** - Vishay Semiconductors product
- 2** - Current rating (40 = 40 A)
- 3** - Schottky "L" series
- 4** - Voltage code 40 = 40 V
45 = 45 V
- 5** - Circuit configuration:
C = common cathode
- 6** - Package:
W = TO-247
- 7** - Environmental digit
-N3 = halogen-free, RoHS-compliant, and totally lead (Pb)-free

ORDERING INFORMATION (Example)			
PREFERRED P/N	QUANTITY PER T/R	MINIMUM ORDER QUANTITY	PACKAGING DESCRIPTION
VS-40L40CW-N3	25	500	Antistatic plastic tube
VS-40L45CW-N3	25	500	Antistatic plastic tube

LINKS TO RELATED DOCUMENTS	
Dimensions	www.vishay.com/doc?96138
Part marking information	www.vishay.com/doc?95007



TO-247AC 3L

DIMENSIONS in millimeters and inches

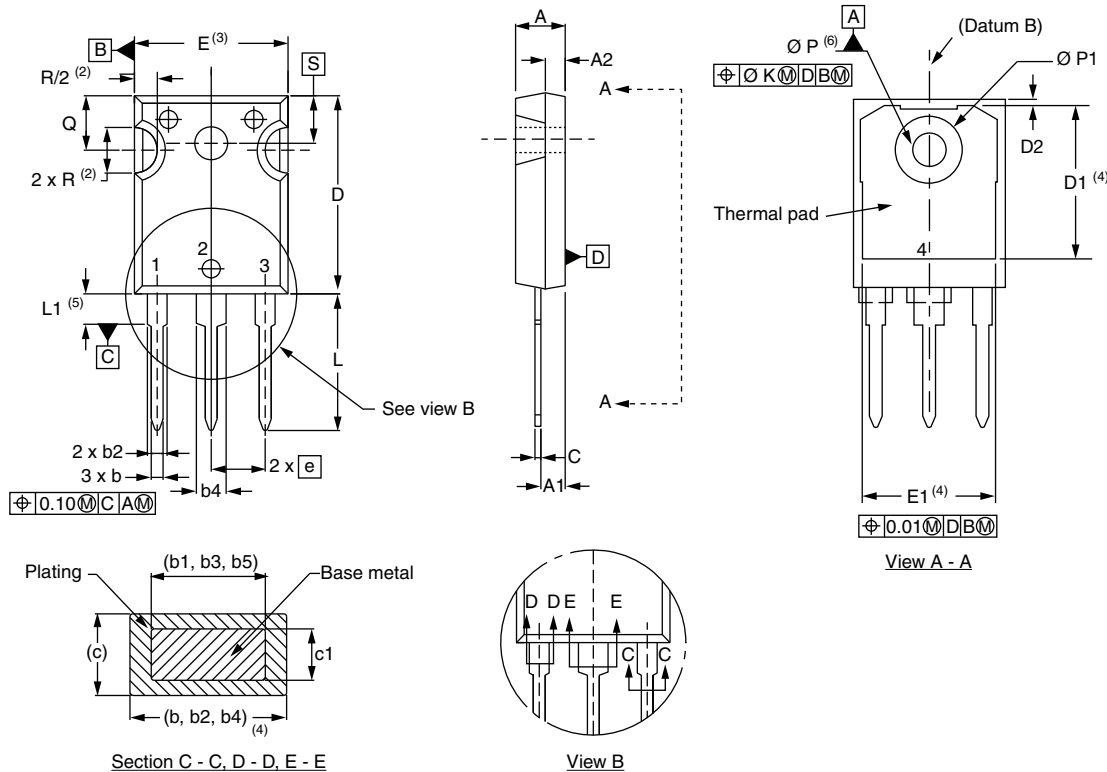

SYMBOL	MILLIMETERS		INCHES		NOTES	SYMBOL	MILLIMETERS		INCHES		NOTES
	MIN.	MAX.	MIN.	MAX.			MIN.	MAX.	MIN.	MAX.	
A	4.65	5.31	0.183	0.209		D2	0.51	1.35	0.020	0.053	
A1	2.21	2.59	0.087	0.102		E	15.29	15.87	0.602	0.625	3
A2	1.17	1.37	0.046	0.054		E1	13.46	-	0.53	-	
b	0.99	1.40	0.039	0.055		e	5.46 BSC		0.215 BSC		
b1	0.99	1.35	0.039	0.053		Ø K	0.254		0.010		
b2	1.65	2.39	0.065	0.094		L	14.20	16.10	0.559	0.634	
b3	1.65	2.34	0.065	0.092		L1	3.71	4.29	0.146	0.169	
b4	2.59	3.43	0.102	0.135		Ø P	3.56	3.66	0.14	0.144	
b5	2.59	3.38	0.102	0.133		Ø P1	-	7.39	-	0.291	
c	0.38	0.89	0.015	0.035		Q	5.31	5.69	0.209	0.224	
c1	0.38	0.84	0.015	0.033		R	4.52	5.49	0.178	0.216	
D	19.71	20.70	0.776	0.815	3	S	5.51 BSC		0.217 BSC		
D1	13.08	-	0.515	-	4						

Notes

- (1) Dimensioning and tolerancing per ASME Y14.5M-1994
- (2) Contour of slot optional
- (3) Dimension D and E do not include mold flash. Mold flash shall not exceed 0.127 mm (0.005") per side. These dimensions are measured at the outermost extremes of the plastic body
- (4) Thermal pad contour optional with dimensions D1 and E1
- (5) Lead finish uncontrolled in L1
- (6) Ø P to have a maximum draft angle of 1.5 to the top of the part with a maximum hole diameter of 3.91 mm (0.154")
- (7) Outline conforms to JEDEC® outline TO-247 with exception of dimension Q



Disclaimer

ALL PRODUCT, PRODUCT SPECIFICATIONS AND DATA ARE SUBJECT TO CHANGE WITHOUT NOTICE TO IMPROVE RELIABILITY, FUNCTION OR DESIGN OR OTHERWISE.

Vishay Intertechnology, Inc., its affiliates, agents, and employees, and all persons acting on its or their behalf (collectively, "Vishay"), disclaim any and all liability for any errors, inaccuracies or incompleteness contained in any datasheet or in any other disclosure relating to any product.

Vishay makes no warranty, representation or guarantee regarding the suitability of the products for any particular purpose or the continuing production of any product. To the maximum extent permitted by applicable law, Vishay disclaims (i) any and all liability arising out of the application or use of any product, (ii) any and all liability, including without limitation special, consequential or incidental damages, and (iii) any and all implied warranties, including warranties of fitness for particular purpose, non-infringement and merchantability.

Statements regarding the suitability of products for certain types of applications are based on Vishay's knowledge of typical requirements that are often placed on Vishay products in generic applications. Such statements are not binding statements about the suitability of products for a particular application. It is the customer's responsibility to validate that a particular product with the properties described in the product specification is suitable for use in a particular application. Parameters provided in datasheets and / or specifications may vary in different applications and performance may vary over time. All operating parameters, including typical parameters, must be validated for each customer application by the customer's technical experts. Product specifications do not expand or otherwise modify Vishay's terms and conditions of purchase, including but not limited to the warranty expressed therein.

Except as expressly indicated in writing, Vishay products are not designed for use in medical, life-saving, or life-sustaining applications or for any other application in which the failure of the Vishay product could result in personal injury or death. Customers using or selling Vishay products not expressly indicated for use in such applications do so at their own risk. Please contact authorized Vishay personnel to obtain written terms and conditions regarding products designed for such applications.

No license, express or implied, by estoppel or otherwise, to any intellectual property rights is granted by this document or by any conduct of Vishay. Product names and markings noted herein may be trademarks of their respective owners.

X-ON Electronics

Largest Supplier of Electrical and Electronic Components

Click to view similar products for [Schottky Diodes & Rectifiers](#) category:

Click to view products by [Vishay](#) manufacturer:

Other Similar products are found below :

[CUS06\(TE85L,Q,M\)](#) [MA4E2039](#) [D1FH3-5063](#) [MBR0530L-TP](#) [MBR10100CT-BP](#) [MBR30H100MFST1G](#) [MMBD301M3T5G](#) [PMAD1103-LF](#) [RB160M-50TR](#) [RB520S-30](#) [RB551V-30](#) [DD350N18K](#) [DZ435N40K](#) [DZ600N16K](#) [BAS16E6433HTMA1](#) [BAS 3010S-02LRH E6327](#) [BAT 54-02LRH E6327](#) [NSR05F40QNXT5G](#) [JANS1N6640](#) [SB07-03C-TB-H](#) [SB1003M3-TL-W](#) [SBAT54CWT1G](#) [SK32A-LTP](#) [SK33A-TP](#) [SK34A-TP](#) [SK34B-TP](#) [SMD1200PL-TP](#) [ACDBN160-HF](#) [SS3003CH-TL-E](#) [STPS30S45CW](#) [PDS3100Q-7](#) [GA01SHT18](#) [CRS10I30A\(TE85L,QM\)](#) [MA4E2501L-1290](#) [MBR1240MFST1G](#) [MBRB30H30CT-1G](#) [BAS28E6433HTMA1](#) [BAS 70-02L E6327](#) [VS-STPS40L45CW-N3](#) [DD350N12K](#) [SB007-03C-TB-E](#) [SK110-LTP](#) [SK154-TP](#) [SK32A-TP](#) [SK33B-TP](#) [SK35A-TP](#) [SK38B-LTP](#) [SK38B-TP](#) [NRVB10100MFST1G](#) [NRVB560MFST1G](#)