

Thyristor High Voltage, Phase Control SCR, 40 A

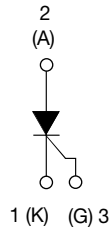

FEATURES

- Designed and qualified according to JEDEC-JESD47
- 140 °C max. operating junction temperature
- Material categorization:
For definitions of compliance please see www.vishay.com/doc?99912

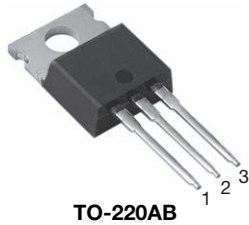

RoHS
COMPLIANT
HALOGEN
FREE
Available

APPLICATIONS

- Typical usage is in input rectification crowbar (soft start) and AC switch in motor control, UPS, welding, and battery charge

DESCRIPTION

The VS-40TTS12... high voltage series of silicon controlled rectifiers are specifically designed for medium power switching and phase control applications. The glass passivation technology used has reliable operation up to 140 °C junction temperature.

PRODUCT SUMMARY	
Package	TO-220AB
Diode variation	Single SCR
$I_{T(AV)}$	25 A
V_{DRM}/V_{RRM}	1200 V
V_{TM}	1.6 V
I_{GT}	35 mA
T_J	- 40 °C to 140 °C

MAJOR RATINGS AND CHARACTERISTICS			
PARAMETER	TEST CONDITIONS	VALUES	UNITS
$I_{T(AV)}$	Sinusoidal waveform	25	A
I_{RMS}		40	
V_{RRM}/V_{DRM}		1200	V
I_{TSM}		350	A
V_T	$T_J = 25\text{ °C}$	1.6	V
dV/dt		500	V/μs
dI/dt		150	A/μs
T_J		- 40 to 140	°C

VOLTAGE RATINGS			
PART NUMBER	V_{RRM} , MAXIMUM PEAK REVERSE VOLTAGE V	V_{DRM} , MAXIMUM PEAK DIRECT VOLTAGE V	T_J °C
VS-40TTS12PbF, VS-40TTS12-M3	1200	1200	- 25 to 140



ABSOLUTE MAXIMUM RATINGS				
PARAMETER	SYMBOL	TEST CONDITIONS	VALUES	UNITS
Maximum average on-state current	$I_{T(AV)}$	$T_C = 93\text{ }^\circ\text{C}$, 180° conduction half sine wave	25	A
Maximum RMS on-state current	I_{RMS}		40	
Maximum peak, one-cycle non-repetitive surge current	I_{TSM}	10 ms sine pulse, rated V_{RRM} applied	300	
		10 ms sine pulse, no voltage reapplied	350	
Maximum I^2t for fusing	I^2t	10 ms sine pulse, rated V_{RRM} applied	450	A ² s
		10 ms sine pulse, no voltage reapplied	630	
Maximum $I^2\sqrt{t}$ for fusing	$I^2\sqrt{t}$	$t = 0.1$ to 10 ms, no voltage reapplied	6300	A ² √s
Maximum on-state voltage	V_{TM}	80 A, $T_J = 25\text{ }^\circ\text{C}$	1.6	V
Low level value of on-state slope resistance	r_t	$T_J = 140\text{ }^\circ\text{C}$	11.4	mΩ
Low level value of threshold voltage	$V_{T(TO)}$		0.96	V
Maximum reverse and direct leakage current	I_{RRM}/I_{DRM}	$V_R = \text{Rated } V_{RRM}/V_{DRM}$	$T_J = 25\text{ }^\circ\text{C}$	0.5
			$T_J = 140\text{ }^\circ\text{C}$	12
Holding current	I_H	Anode supply = 6 V, resistive load, initial $I_T = 1$ A, $T_J = 25\text{ }^\circ\text{C}$	100	mA
Maximum latching current	I_L	Anode supply = 6 V, resistive load, $T_J = 25\text{ }^\circ\text{C}$	200	
Maximum rate of rise of off-state voltage	dV/dt	$T_J = T_J \text{ max.}$, linear to 80 °C, $V_{DRM} = R_g - k = \text{Open}$	500	V/μs
Maximum rate of rise of turned-on current	dI/dt		150	A/μs

TRIGGERING				
PARAMETER	SYMBOL	TEST CONDITIONS	VALUES	UNITS
Maximum peak gate power	P_{GM}		8.0	W
Maximum average gate power	$P_{G(AV)}$		2.0	
Maximum peak positive gate current	+ I_{GM}		1.5	A
Maximum peak negative gate voltage	- V_{GM}		10	V
Maximum required DC gate current to trigger	I_{GT}	Anode supply = 6 V, resistive load, $T_J = 25\text{ }^\circ\text{C}$	35	mA
Maximum required DC gate voltage to trigger	V_{GT}	Anode supply = 6 V, resistive load, $T_J = 25\text{ }^\circ\text{C}$	1.3	V
Maximum DC gate voltage not to trigger	V_{GD}	$T_J = 140\text{ }^\circ\text{C}$, $V_{DRM} = \text{Rated value}$	0.2	
Maximum DC gate current not to trigger	I_{GD}		1.5	mA

SWITCHING				
PARAMETER	SYMBOL	TEST CONDITIONS	VALUES	UNITS
Typical turn-on time	t_{gt}	$T_J = 25\text{ }^\circ\text{C}$	0.9	μs
Typical reverse recovery time	t_{rr}	$T_J = 140\text{ }^\circ\text{C}$	4	
Typical turn-off time	t_q		110	

THERMAL AND MECHANICAL SPECIFICATIONS				
PARAMETER	SYMBOL	TEST CONDITIONS	VALUES	UNITS
Maximum junction and storage temperature range	T_J, T_{Stg}		- 40 to 140	°C
Maximum thermal resistance, junction to case	R_{thJC}	DC operation	0.8	°C/W
Maximum thermal resistance, junction to ambient	R_{thJA}		60	
Typical thermal resistance, case to heatsink	R_{thCS}	Mounting surface, smooth and greased	0.5	
Approximate weight			2	g
			0.07	oz.
Mounting torque	minimum		6 (5)	kgf · cm (lbf · in)
	maximum		12 (10)	
Marking device		Case style TO-220AB	40TTS12	

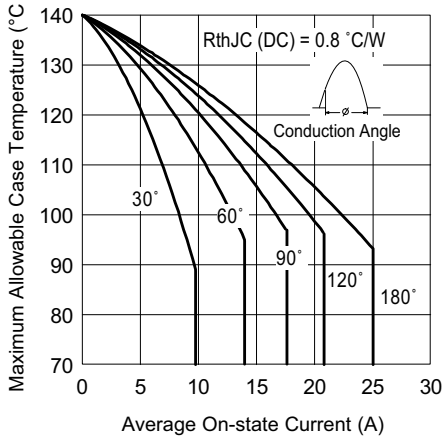

Fig. 1 - Current Rating Characteristics

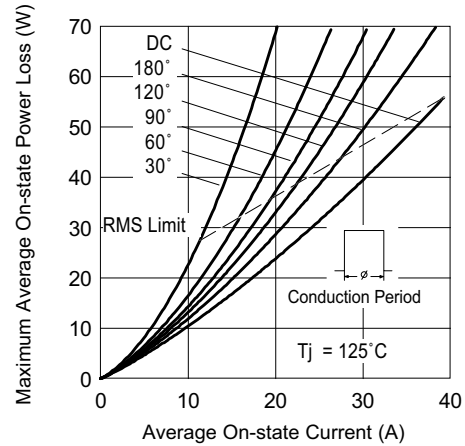

Fig. 4 - On-State Power Loss Characteristics

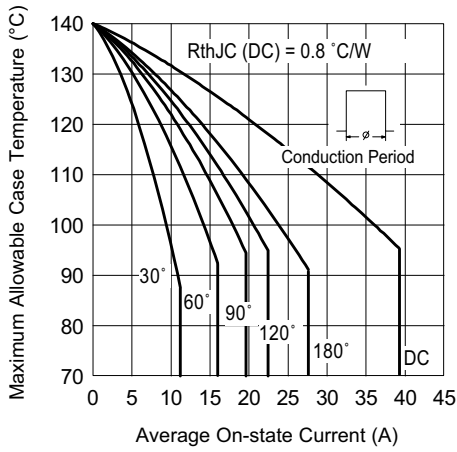

Fig. 2 - Current Rating Characteristics

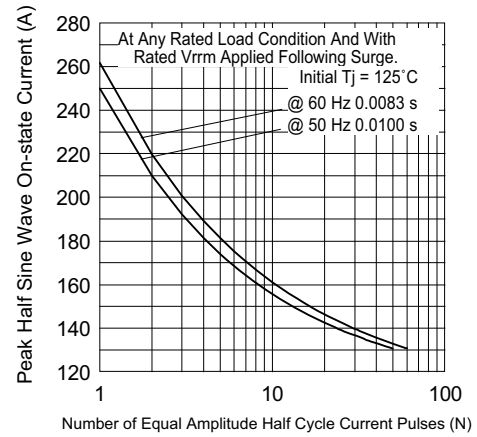

Fig. 5 - Maximum Non-Repetitive Surge Current

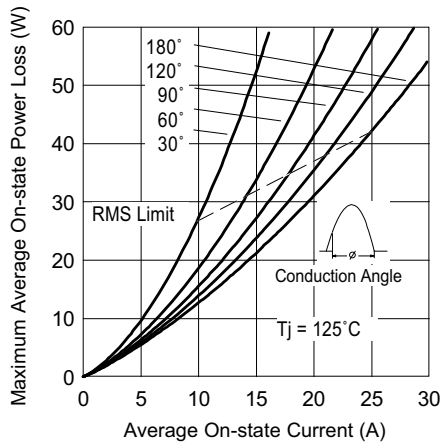

Fig. 3 - On-State Power Loss Characteristics

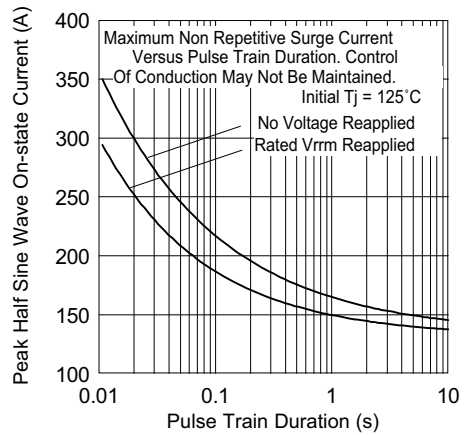

Fig. 6 - Maximum Non-Repetitive Surge Current

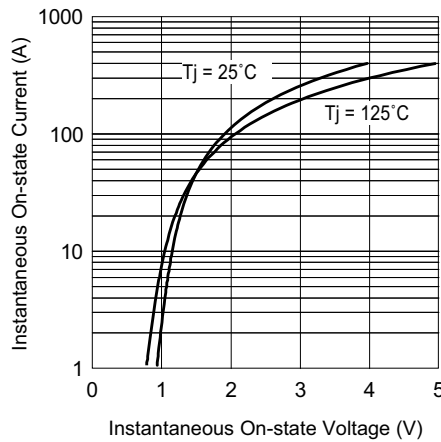

Fig. 7 - On-State Voltage Drop Characteristics

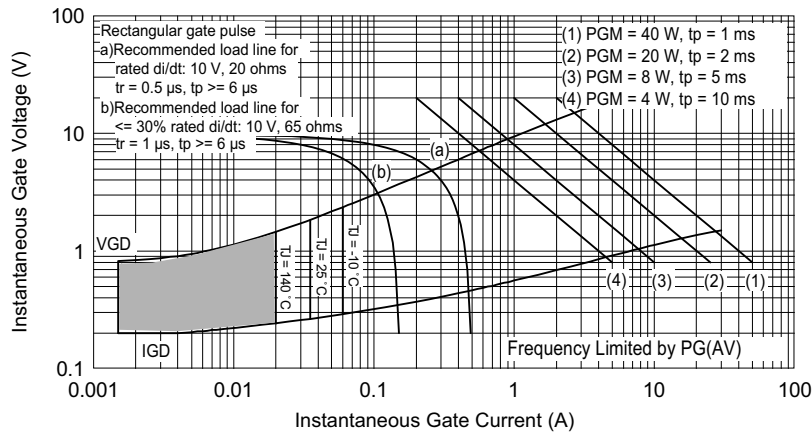

Fig. 8 - Gate Characteristics

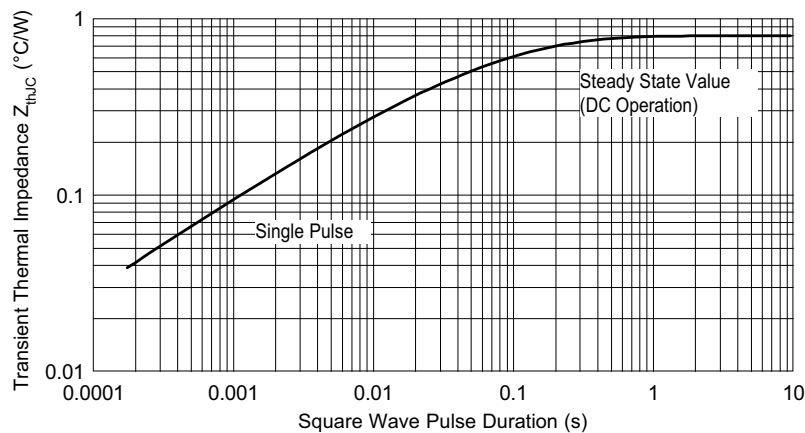
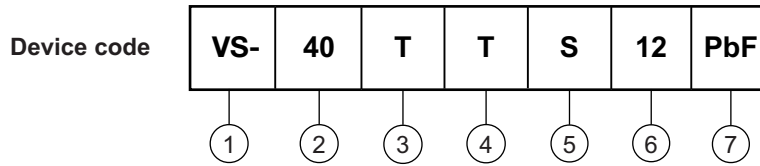

Fig. 9 - Thermal Impedance Z_{thJC} Characteristics



ORDERING INFORMATION TABLE



- 1** - Vishay Semiconductors product
- 2** - Current rating, RMS value
- 3** - Circuit configuration:
T = Single thyristor
- 4** - Package:
T = TO-220
- 5** - Type of silicon:
S = Standard recovery rectifier
- 6** - Voltage rating (12 = 1200 V)
- 7** - Environmental digit:
PbF = Lead (Pb)-free and RoHS compliant
-M3 = Halogen-free, RoHS compliant, and terminations lead (Pb)-free

ORDERING INFORMATION (Example)			
PREFERRED P/N	QUANTITY PER T/R	MINIMUM ORDER QUANTITY	PACKAGING DESCRIPTION
VS-40TTS12PbF	50	1000	Antistatic plastic tubes
VS-40TTS12-M3	50	1000	Antistatic plastic tubes

LINKS TO RELATED DOCUMENTS	
Dimensions	www.vishay.com/doc?95222
Part marking information	TO-220AB PbF www.vishay.com/doc?95225
	TO-220AB -M3 www.vishay.com/doc?95028

TO-220AB

DIMENSIONS in millimeters and inches

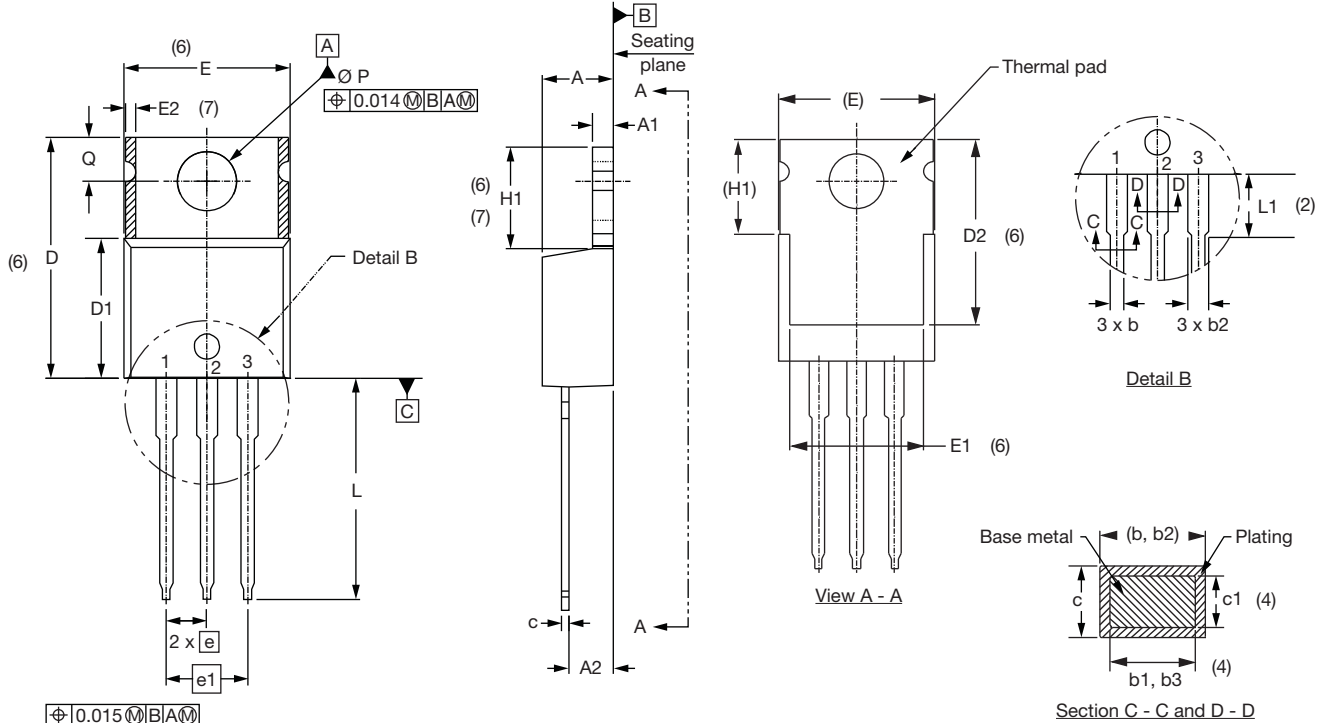

SYMBOL	MILLIMETERS		INCHES		NOTES
	MIN.	MAX.	MIN.	MAX.	
A	4.25	4.65	0.167	0.183	
A1	1.14	1.40	0.045	0.055	
A2	2.56	2.92	0.101	0.115	
b	0.69	1.01	0.027	0.040	
b1	0.38	0.97	0.015	0.038	4
b2	1.20	1.73	0.047	0.068	
b3	1.14	1.73	0.045	0.068	4
c	0.36	0.61	0.014	0.024	
c1	0.36	0.56	0.014	0.022	4
D	14.85	15.25	0.585	0.600	3
D1	8.38	9.02	0.330	0.355	
D2	11.68	12.88	0.460	0.507	6

SYMBOL	MILLIMETERS		INCHES		NOTES
	MIN.	MAX.	MIN.	MAX.	
E	10.11	10.51	0.398	0.414	3, 6
E1	6.86	8.89	0.270	0.350	6
E2	-	0.76	-	0.030	7
e	2.41	2.67	0.095	0.105	
e1	4.88	5.28	0.192	0.208	
H1	6.09	6.48	0.240	0.255	6, 7
L	13.52	14.02	0.532	0.552	
L1	3.32	3.82	0.131	0.150	2
Ø P	3.54	3.73	0.139	0.147	
Q	2.60	3.00	0.102	0.118	
θ	90° to 93°		90° to 93°		

Notes

- Dimensioning and tolerancing as per ASME Y14.5M-1994
- Lead dimension and finish uncontrolled in L1
- Dimension D, D1 and E do not include mold flash. Mold flash shall not exceed 0.127 mm (0.005") per side. These dimensions are measured at the outermost extremes of the plastic body
- Dimension b1, b3 and c1 apply to base metal only
- Controlling dimensions: inches
- Thermal pad contour optional within dimensions E, H1, D2 and E1
- Dimensions E2 x H1 define a zone where stamping and singulation irregularities are allowed
- Outline conforms to JEDEC TO-220, except A2 (maximum) and D2 (minimum) where dimensions are derived from the actual package outline



Disclaimer

ALL PRODUCT, PRODUCT SPECIFICATIONS AND DATA ARE SUBJECT TO CHANGE WITHOUT NOTICE TO IMPROVE RELIABILITY, FUNCTION OR DESIGN OR OTHERWISE.

Vishay Intertechnology, Inc., its affiliates, agents, and employees, and all persons acting on its or their behalf (collectively, "Vishay"), disclaim any and all liability for any errors, inaccuracies or incompleteness contained in any datasheet or in any other disclosure relating to any product.

Vishay makes no warranty, representation or guarantee regarding the suitability of the products for any particular purpose or the continuing production of any product. To the maximum extent permitted by applicable law, Vishay disclaims (i) any and all liability arising out of the application or use of any product, (ii) any and all liability, including without limitation special, consequential or incidental damages, and (iii) any and all implied warranties, including warranties of fitness for particular purpose, non-infringement and merchantability.

Statements regarding the suitability of products for certain types of applications are based on Vishay's knowledge of typical requirements that are often placed on Vishay products in generic applications. Such statements are not binding statements about the suitability of products for a particular application. It is the customer's responsibility to validate that a particular product with the properties described in the product specification is suitable for use in a particular application. Parameters provided in datasheets and/or specifications may vary in different applications and performance may vary over time. All operating parameters, including typical parameters, must be validated for each customer application by the customer's technical experts. Product specifications do not expand or otherwise modify Vishay's terms and conditions of purchase, including but not limited to the warranty expressed therein.

Except as expressly indicated in writing, Vishay products are not designed for use in medical, life-saving, or life-sustaining applications or for any other application in which the failure of the Vishay product could result in personal injury or death. Customers using or selling Vishay products not expressly indicated for use in such applications do so at their own risk. Please contact authorized Vishay personnel to obtain written terms and conditions regarding products designed for such applications.

No license, express or implied, by estoppel or otherwise, to any intellectual property rights is granted by this document or by any conduct of Vishay. Product names and markings noted herein may be trademarks of their respective owners.

Material Category Policy

Vishay Intertechnology, Inc. hereby certifies that all its products that are identified as RoHS-Compliant fulfill the definitions and restrictions defined under Directive 2011/65/EU of The European Parliament and of the Council of June 8, 2011 on the restriction of the use of certain hazardous substances in electrical and electronic equipment (EEE) - recast, unless otherwise specified as non-compliant.

Please note that some Vishay documentation may still make reference to RoHS Directive 2002/95/EC. We confirm that all the products identified as being compliant to Directive 2002/95/EC conform to Directive 2011/65/EU.

Vishay Intertechnology, Inc. hereby certifies that all its products that are identified as Halogen-Free follow Halogen-Free requirements as per JEDEC JS709A standards. Please note that some Vishay documentation may still make reference to the IEC 61249-2-21 definition. We confirm that all the products identified as being compliant to IEC 61249-2-21 conform to JEDEC JS709A standards.

X-ON Electronics

Largest Supplier of Electrical and Electronic Components

Click to view similar products for [SCRs category](#):

Click to view products by [Vishay manufacturer](#):

Other Similar products are found below :

[NTE5428](#) [T1500N16TOF VT](#) [T880N16TOF](#) [TT162N16KOF-A](#) [TT162N16KOF-K](#) [TT330N16AOF](#) [VS-22RIA20](#) [VS-2N685](#) [057219R](#)
[T1190N16TOF VT](#) [T1220N22TOF VT](#) [T201N70TOH](#) [T700N22TOF](#) [T830N18TOF](#) [TT250N12KOF-K](#) [VS-110RKI40](#) [NTE5427](#) [NTE5442](#)
[T2160N28TOF VT](#) [TT251N16KOF-K](#) [VS-22RIA100](#) [VS-16RIA40](#) [TD250N16KOF-A](#) [VS-ST110S16P0](#) [T930N36TOF VT](#) [T2160N24TOF](#)
[VT](#) [T1190N18TOF VT](#) [T1590N28TOF VT](#) [2N1776A](#) [T590N14TOF](#) [NTE5375](#) [NTE5460](#) [NTE5481](#) [NTE5512](#) [NTE5514](#) [NTE5518](#)
[NTE5519](#) [NTE5529](#) [NTE5553](#) [NTE5555](#) [NTE5557](#) [NTE5567](#) [NTE5570](#) [NTE5572](#) [NTE5574](#) [NTE5576](#) [NTE5579](#) [NTE5589](#) [NTE5592](#)
[NTE5598](#)