

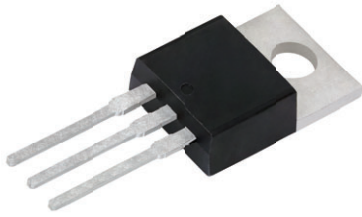

## High Performance Schottky Rectifier, 2 x 30 A

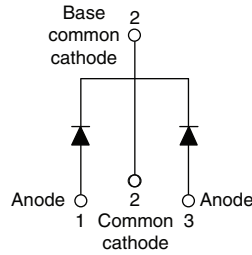

3L TO-220AB



### FEATURES

- 150 °C T<sub>J</sub> operation
- Low forward voltage drop
- High frequency operation
- High purity, high temperature epoxy encapsulation for enhanced mechanical strength and moisture resistance
- Guard ring for enhanced ruggedness and long term reliability
- Designed and qualified according to JEDEC®-JESD 47
- Material categorization: for definitions of compliance please see [www.vishay.com/doc?99912](http://www.vishay.com/doc?99912)



RoHS  
COMPLIANT  
HALOGEN  
FREE

| PRIMARY CHARACTERISTICS          |                  |
|----------------------------------|------------------|
| I <sub>F(AV)</sub>               | 2 x 30 A         |
| V <sub>R</sub>                   | 35 V, 40 V, 45 V |
| V <sub>F</sub> at I <sub>F</sub> | 0.53 V           |
| I <sub>FRM</sub> max.            | 250 mA at 125 °C |
| T <sub>J</sub> max.              | 150 °C           |
| E <sub>AS</sub>                  | 20 mJ            |
| Package                          | 3L TO-220AB      |
| Circuit configuration            | Common cathode   |

### DESCRIPTION

This center tap Schottky rectifier has been optimized for low reverse leakage at high temperature. The proprietary barrier technology allows for reliable operation up to 150 °C junction temperature. Typical applications are in switching power supplies, converters, freewheeling diodes, and reverse battery protection.

| MAJOR RATINGS AND CHARACTERISTICS |  |             |       |
|-----------------------------------|--|-------------|-------|
| SYMBOL                            | CHARACTERISTICS                              | VALUES      | UNITS |
| I <sub>F(AV)</sub>                | Rectangular waveform (per device)            | 60          | A     |
| V <sub>R</sub>                    |  | 35 to 45    | V     |
| I <sub>FRM</sub>                  | T <sub>C</sub> = 113 °C (per leg)            | 60          | A     |
| I <sub>FSM</sub>                  | t <sub>p</sub> = 5 μs sine                   | 1500        |       |
| V <sub>F</sub>                    | 30 A <sub>pk</sub> , T <sub>J</sub> = 125 °C | 0.53        | V     |
| T <sub>J</sub>                    | Range  | -65 to +150 | °C    |

| VOLTAGE RATINGS                      |                  |                |                |                |       |
|--------------------------------------|------------------|----------------|----------------|----------------|-------|
| PARAMETER                            | SYMBOL           | VS-60CTQ035-M3 | VS-60CTQ040-M3 | VS-60CTQ045-M3 | UNITS |
| Maximum DC reverse voltage           | V <sub>R</sub>   | 35             | 40             | 45             | V     |
| Maximum working peak reverse voltage | V <sub>RWM</sub> |                |                |                |       |

| ABSOLUTE MAXIMUM RATINGS                                    |                    |  |        |       |
|---|--------------------|--|--------|-------|
| PARAMETER   | SYMBOL             | TEST CONDITIONS  | VALUES | UNITS |
| Maximum average forward current                             | I <sub>F(AV)</sub> | 50 % duty cycle at T <sub>C</sub> = 113 °C, rectangular waveform   | 30     | A     |
|   |                    |  | 60     |       |
| Peak repetitive forward current per leg                     | I <sub>FRM</sub>   | Rated V <sub>R</sub> , square wave, 20 kHz, T <sub>C</sub> = 113 °C  | 60     | A     |
| Maximum peak one cycle non-repetitive surge current per leg | I <sub>FSM</sub>   | 5 μs sine or 3 μs rect. pulse  | 1500   |       |
|   |                    | 10 ms sine or 6 ms rect. pulse   | 300    |       |
| Non-repetitive avalanche energy per leg                     | E <sub>AS</sub>    | T <sub>J</sub> = 25 °C, I <sub>AS</sub> = 3 A, L = 4.40 mH   | 20     | mJ    |
| Repetitive avalanche current per leg                        | I <sub>AR</sub>    | Current decaying linearly to zero in 1 μs<br>Frequency limited by T <sub>J</sub> maximum V <sub>A</sub> = 1.5 x V <sub>R</sub> typical | 3      | A     |



| <b>ELECTRICAL SPECIFICATIONS</b>      |                |  |                                   |      |                  |    |
|---------------------------------------|----------------|--|-----------------------------------|------|------------------|----|
| PARAMETER                             | SYMBOL         | TEST CONDITIONS  | TYP.                              | MAX. | UNITS            |    |
| Maximum forward voltage drop          | $V_{FM}^{(1)}$ | 30 A   | $T_J = 25\text{ }^\circ\text{C}$  | 0.51 | 0.56             | V  |
|                                       |                | 60 A   |                                   | 0.66 | 0.72             |    |
|                                       |                | 30 A   | $T_J = 125\text{ }^\circ\text{C}$ | 0.48 | 0.53             |    |
|                                       |                | 60 A   |                                   | 0.68 | 0.75             |    |
| Maximum instantaneous reverse current | $I_{RM}$       | $T_J = 25\text{ }^\circ\text{C}$   | Rated DC voltage                  | 0.33 | 2                | mA |
|                                       |                | $T_J = 125\text{ }^\circ\text{C}$  |                                   | 145  | 250              |    |
| Maximum junction capacitance          | $C_T$          | $V_R = 5 V_{DC}$ (test signal range 100 kHz to 1 MHz) $25\text{ }^\circ\text{C}$ | 2000                              |      | pF               |    |
| Typical series inductance             | $L_S$          | Measured from top of terminal to mounting plane                                  | 8.0                               |      | nH               |    |
| Maximum voltage rate of change        | dV/dt          | Rated $V_R$  | 10 000                            |      | V/ $\mu\text{s}$ |    |

**Note**

(1) Pulse width < 300  $\mu\text{s}$ , duty cycle < 2 %

| <b>THERMAL - MECHANICAL SPECIFICATIONS</b>           |            |                                      |             |                        |
|--|------------|--------------------------------------|-------------|------------------------|
| PARAMETER  | SYMBOL     | TEST CONDITIONS                      | VALUES      | UNITS                  |
| Maximum junction temperature range                   | $T_J$      |                                      | -65 to +150 | $^\circ\text{C}$       |
| Maximum storage temperature range                    | $T_{Stg}$  |                                      | -65 to +175 |                        |
| Maximum thermal resistance, junction to case per leg | $R_{thJC}$ | DC operation                         | 1.2         | $^\circ\text{C/W}$     |
| Typical thermal resistance, case to heatsink         | $R_{thCS}$ | Mounting surface, smooth and greased | 0.50        |                        |
| Approximate weight                                   |            |                                      | 2           | g                      |
|  |            |                                      | 0.07        | oz.                    |
| Mounting torque                                      | minimum    | Non-lubricated threads               | 6 (5)       | kgf · cm<br>(lbf · in) |
|  | maximum    |                                      | 12 (10)     |                        |
| Marking device                                       |            | Case style 3L TO-220AB               | 60CTQ035    |                        |
|  |            |                                      | 60CTQ040    |                        |
|  |            |                                      | 60CTQ045    |                        |

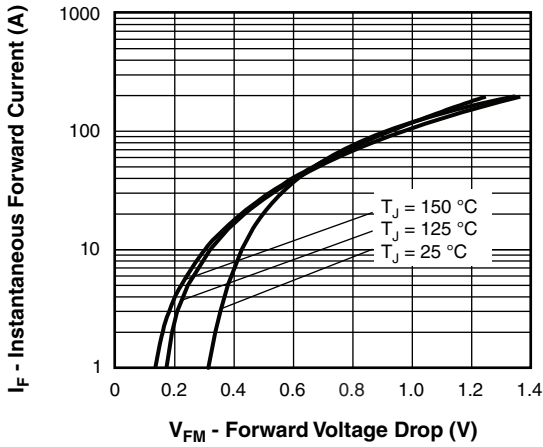

Fig. 1 - Maximum Forward Voltage Drop Characteristics

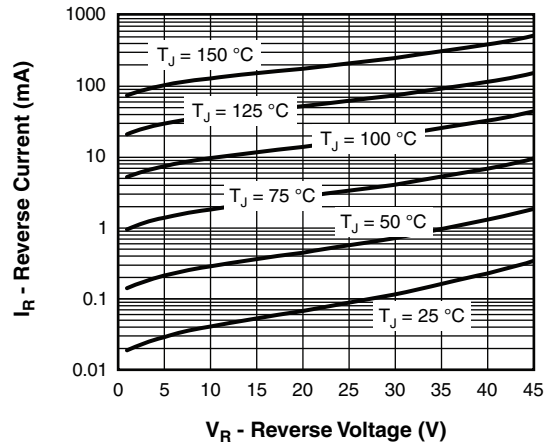

Fig. 2 - Typical Values of Reverse Current vs. Reverse Voltage

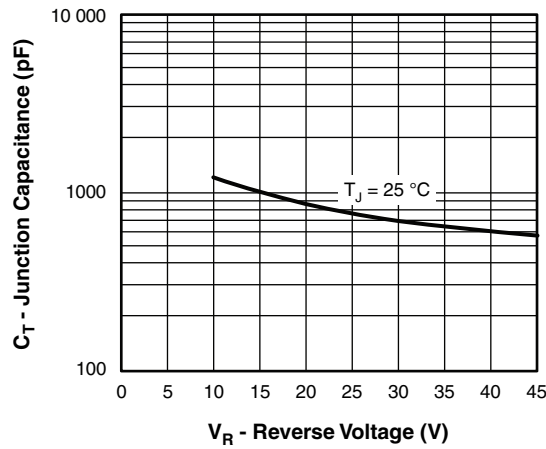

Fig. 3 - Typical Junction Capacitance vs. Reverse Voltage

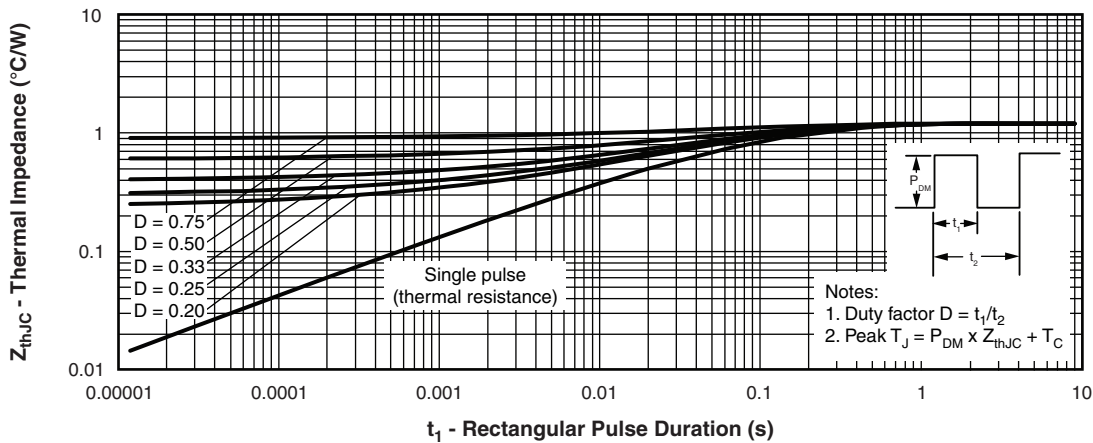

Fig. 4 - Maximum Thermal Impedance  $Z_{thJC}$  Characteristics

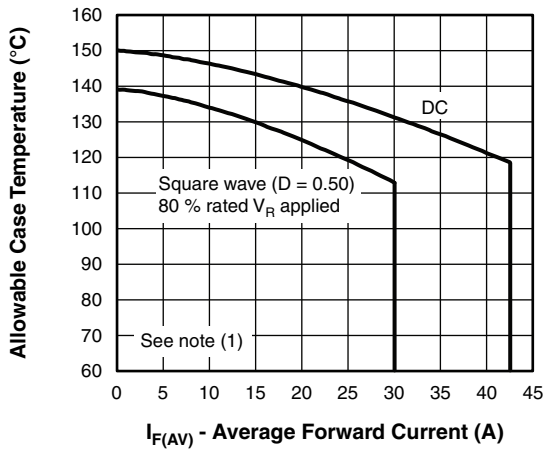

Fig. 5 - Maximum Allowable Case Temperature vs. Average Forward Current

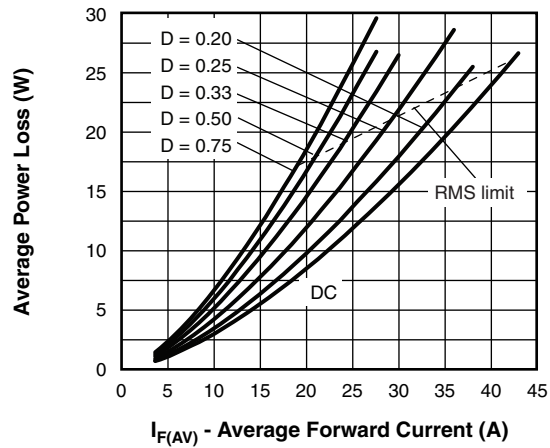

Fig. 6 - Forward Power Loss Characteristics

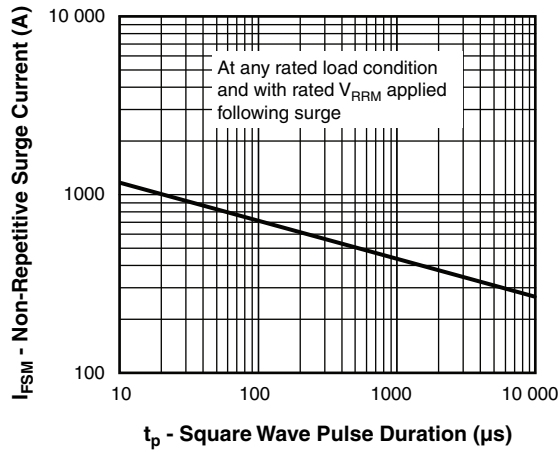

Fig. 7 - Maximum Non-Repetitive Surge Current (Per Leg)

**Note**

- (1) Formula used:  $T_C = T_J - (P_d + P_{d_{REV}}) \times R_{thJC}$ ;
- $P_d$  = forward power loss =  $I_{F(AV)} \times V_{FM}$  at  $(I_{F(AV)}/D)$  (see fig. 6);
- $P_{d_{REV}}$  = inverse power loss =  $V_{R1} \times I_R (1 - D)$ ;  $I_R$  at  $V_{R1} = 80\%$  rated  $V_R$



## ORDERING INFORMATION TABLE

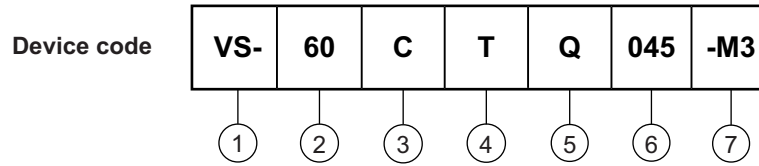

- 1** - Vishay Semiconductors product
  - 2** - Current rating (60 = 60 A)
  - 3** - Circuit configuration  
C = common cathode
  - 4** - Package  
T = TO-220
  - 5** - Schottky "Q" series
  - 6** - Voltage ratings
 

|            |
|------------|
| 035 = 35 V |
| 040 = 40 V |
| 045 = 45 V |
  - 7** - Environmental digit
- M3 = halogen-free, RoHS-compliant, and termination lead (Pb)-free

| ORDERING INFORMATION (Example) |                  |                        |                         |
|--------------------------------|------------------|------------------------|-------------------------|
| PREFERRED P/N                  | QUANTITY PER T/R | MINIMUM ORDER QUANTITY | PACKAGING DESCRIPTION   |
| VS-60CTQ035-M3                 | 50               | 1000                   | Antistatic plastic tube |
| VS-60CTQ040-M3                 | 50               | 1000                   | Antistatic plastic tube |
| VS-60CTQ045-M3                 | 50               | 1000                   | Antistatic plastic tube |

| LINKS TO RELATED DOCUMENTS |  |
|----------------------------|--|
| Dimensions                 | <a href="http://www.vishay.com/doc?96154">www.vishay.com/doc?96154</a> |
| Part marking information   | <a href="http://www.vishay.com/doc?95028">www.vishay.com/doc?95028</a> |



# 3L TO-220AB

**DIMENSIONS** in millimeters and inches

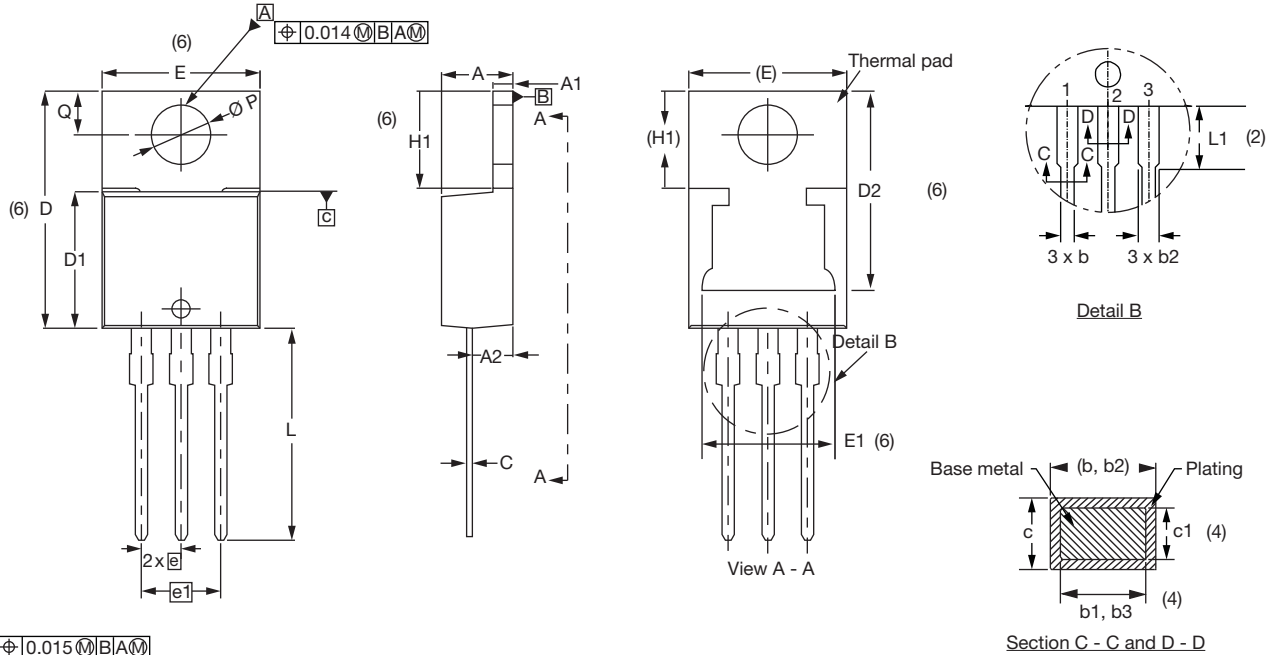

Conforms to JEDEC® outline TO-220AB

| SYMBOL | MILLIMETERS |       | INCHES |       | NOTES | SYMBOL          | MILLIMETERS |       | INCHES |       | NOTES |
|--------|-------------|-------|--------|-------|-------|-----------------|-------------|-------|--------|-------|-------|
|        | MIN.        | MAX.  | MIN.   | MAX.  |       |                 | MIN.        | MAX.  | MIN.   | MAX.  |       |
| A      | 4.25        | 4.65  | 0.167  | 0.183 |       | D2              | 11.68       | 13.30 | 0.460  | 0.524 | 6, 7  |
| A1     | 1.14        | 1.40  | 0.045  | 0.055 |       | E               | 10.11       | 10.51 | 0.398  | 0.414 | 3, 6  |
| A2     | 2.50        | 2.92  | 0.098  | 0.115 |       | E1              | 6.86        | 8.89  | 0.270  | 0.350 | 6     |
| b      | 0.69        | 1.01  | 0.027  | 0.040 |       | e               | 2.41        | 2.67  | 0.095  | 0.105 |       |
| b1     | 0.38        | 0.97  | 0.015  | 0.038 | 4     | e1              | 4.88        | 5.28  | 0.192  | 0.208 |       |
| b2     | 1.20        | 1.73  | 0.047  | 0.068 |       | H1              | 6.09        | 6.48  | 0.240  | 0.255 | 6     |
| b3     | 1.14        | 1.73  | 0.045  | 0.068 | 4     | L               | 13.52       | 14.02 | 0.532  | 0.552 |       |
| c      | 0.36        | 0.61  | 0.014  | 0.024 |       | L1              | 3.32        | 3.82  | 0.131  | 0.150 | 2     |
| c1     | 0.36        | 0.56  | 0.014  | 0.022 | 4     | $\varnothing P$ | 3.54        | 3.91  | 0.139  | 0.154 |       |
| D      | 14.85       | 15.35 | 0.585  | 0.604 | 3     | Q               | 2.60        | 3.00  | 0.102  | 0.118 |       |
| D1     | 8.38        | 9.02  | 0.330  | 0.355 |       |                 |             |       |        |       |       |

**Notes**

- (1) Dimensioning and tolerancing as per ASME Y14.5M-1994
- (2) Lead dimension and finish uncontrolled in L1
- (3) Dimension D, D1, and E do not include mold flash. Mold flash shall not exceed 0.127 mm (0.005") per side. These dimensions are measured at the outermost extremes of the plastic body
- (4) Dimension b1, b3, and c1 apply to base metal only
- (5) Controlling dimensions: inches
- (6) Thermal pad contour optional within dimensions E, H1, D2, and E1
- (7) Outline conforms to JEDEC® TO-220, except D2



## Disclaimer

ALL PRODUCT, PRODUCT SPECIFICATIONS AND DATA ARE SUBJECT TO CHANGE WITHOUT NOTICE TO IMPROVE RELIABILITY, FUNCTION OR DESIGN OR OTHERWISE.

Vishay Intertechnology, Inc., its affiliates, agents, and employees, and all persons acting on its or their behalf (collectively, "Vishay"), disclaim any and all liability for any errors, inaccuracies or incompleteness contained in any datasheet or in any other disclosure relating to any product.

Vishay makes no warranty, representation or guarantee regarding the suitability of the products for any particular purpose or the continuing production of any product. To the maximum extent permitted by applicable law, Vishay disclaims (i) any and all liability arising out of the application or use of any product, (ii) any and all liability, including without limitation special, consequential or incidental damages, and (iii) any and all implied warranties, including warranties of fitness for particular purpose, non-infringement and merchantability.

Statements regarding the suitability of products for certain types of applications are based on Vishay's knowledge of typical requirements that are often placed on Vishay products in generic applications. Such statements are not binding statements about the suitability of products for a particular application. It is the customer's responsibility to validate that a particular product with the properties described in the product specification is suitable for use in a particular application. Parameters provided in datasheets and / or specifications may vary in different applications and performance may vary over time. All operating parameters, including typical parameters, must be validated for each customer application by the customer's technical experts. Product specifications do not expand or otherwise modify Vishay's terms and conditions of purchase, including but not limited to the warranty expressed therein.

Except as expressly indicated in writing, Vishay products are not designed for use in medical, life-saving, or life-sustaining applications or for any other application in which the failure of the Vishay product could result in personal injury or death. Customers using or selling Vishay products not expressly indicated for use in such applications do so at their own risk. Please contact authorized Vishay personnel to obtain written terms and conditions regarding products designed for such applications.

No license, express or implied, by estoppel or otherwise, to any intellectual property rights is granted by this document or by any conduct of Vishay. Product names and markings noted herein may be trademarks of their respective owners.

## X-ON Electronics

Largest Supplier of Electrical and Electronic Components

*Click to view similar products for [Schottky Diodes & Rectifiers](#) category:*

*Click to view products by [Vishay](#) manufacturer:*

Other Similar products are found below :

[MA4E2039](#) [D1FH3-5063](#) [MBR10100CT-BP](#) [MBR1545CT](#) [MMBD301M3T5G](#) [RB160M-50TR](#) [RB551V-30](#) [BAS16E6433HTMA1](#) [BAT](#)  
[54-02LRH E6327](#) [NSR05F40QNXT5G](#) [NTE555](#) [JANS1N6640](#) [SB07-03C-TB-H](#) [SB1003M3-TL-W](#) [SK310-T](#) [SK32A-LTP](#) [SK33A-TP](#)  
[SK34B-TP](#) [SS3003CH-TL-E](#) [GA01SHT18](#) [CRS10I30A\(TE85L,QM](#) [MA4E2501L-1290](#) [MBRB30H30CT-1G](#) [SB007-03C-TB-E](#) [SK32A-TP](#)  
[SK33B-TP](#) [SK35A-TP](#) [SK38B-TP](#) [NRVBM120LT1G](#) [NTE505](#) [NTSB30U100CT-1G](#) [SS15E-TP](#) [VS-6CWQ10FNHM3](#) [ACDBA1100LR-HF](#)  
[ACDBA1200-HF](#) [ACDBA140-HF](#) [ACDBA2100-HF](#) [ACDBA3100-HF](#) [CDBQC0530L-HF](#) [CDBQC0240LR-HF](#) [ACDBA340-HF](#)  
[ACDBA260LR-HF](#) [ACDBA1100-HF](#) [SK310B-TP](#) [MA4E2502L-1246](#) [MA4E2502H-1246](#) [NRVBM120ET1G](#) [NSR01L30MXT5G](#) [NTE573](#)  
[NTE6081](#)