

Ultrafast Soft Recovery Diode, 30 A FRED Pt® Gen 4

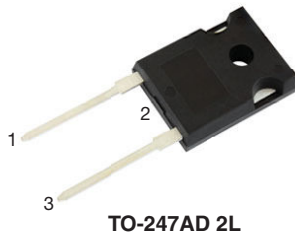

TO-247AD 2L

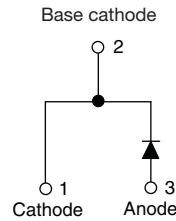

FEATURES

- Gen 4 FRED Pt® technology
- Low I_{RRM} and reverse recovery charge
- Very low forward voltage drop
- Polyimide passivated chip for high reliability standard
- 175 °C operating junction temperature
- Designed and qualified according to JEDEC®-JESD 47
- Material categorization: for definitions of compliance please see www.vishay.com/doc?99912

RoHS
COMPLIANT
HALOGEN
FREE

PRIMARY CHARACTERISTICS	
$I_{F(AV)}$	30 A
V_R	600 V
V_F at I_F	1.19 V
t_{rr} typ.	see Recovery table
T_J max.	175 °C
Package	TO-247AD 2L
Circuit configuration	Single

DESCRIPTION

Gen 4 Fred technology, state of the art, ultralow V_F , soft switching optimized for Discontinuous (Critical) Mode (DCM) and IGBT F/W diode.

The minimized conduction loss, optimized stored charge and low recovery current minimize the switching losses and reduce over dissipation in the switching element and snubbers.

ABSOLUTE MAXIMUM RATINGS				
PARAMETER	SYMBOL	TEST CONDITIONS	MAX.	UNITS
Peak repetitive reverse voltage	V_{RRM}		600	V
Average rectified forward current	$I_{F(AV)}$	$T_C = 131$ °C	30	A
Non-repetitive peak surge current	I_{FSM}	$T_C = 25$ °C, $t_p = 8.3$ ms half sine wave	240	
Operating junction and storage temperature	T_J, T_{Stg}		-55 to +175	°C

ELECTRICAL SPECIFICATIONS ($T_J = 25$ °C unless otherwise specified)						
PARAMETER	SYMBOL	TEST CONDITIONS	MIN.	TYP.	MAX.	UNITS
Breakdown voltage, blocking voltage	V_{BR}, V_R	$I_R = 100$ μ A	600	-	-	V
Forward voltage	V_F	$I_F = 30$ A	-	1.36	1.6	
		$I_F = 60$ A	-	1.6	-	
		$I_F = 30$ A, $T_J = 125$ °C	-	1.23	-	
		$I_F = 60$ A, $T_J = 125$ °C	-	1.5	-	
		$I_F = 30$ A, $T_J = 150$ °C	-	1.19	1.35	
Reverse leakage current	I_R	$V_R = V_R$ rated	-	-	50	μ A
		$T_J = 125$ °C, $V_R = V_R$ rated	-	-	500	
Junction capacitance	C_T	$V_R = 600$ V	-	18.3	-	pF



DYNAMIC RECOVERY CHARACTERISTICS ($T_J = 25\text{ }^\circ\text{C}$ unless otherwise specified)							
PARAMETER	SYMBOL	TEST CONDITIONS		MIN.	TYP.	MAX.	UNITS
Reverse recovery time	t_{rr}	$T_J = 25\text{ }^\circ\text{C}$	$I_F = 30\text{ A}$ $dI_F/dt = 1000\text{ A}/\mu\text{s}$ $V_R = 400\text{ V}$	-	65	-	ns
		$T_J = 125\text{ }^\circ\text{C}$		-	90	-	
Peak recovery current	I_{RRM}	$T_J = 25\text{ }^\circ\text{C}$		-	18	-	A
		$T_J = 125\text{ }^\circ\text{C}$		-	32	-	
Reverse recovery charge	Q_{rr}	$T_J = 25\text{ }^\circ\text{C}$		-	850	-	nC
		$T_J = 125\text{ }^\circ\text{C}$		-	1850	-	

THERMAL - MECHANICAL SPECIFICATIONS							
PARAMETER	SYMBOL	TEST CONDITIONS		MIN.	TYP.	MAX.	UNITS
Thermal resistance, junction to case	R_{thJC}			-	-	0.9	$^\circ\text{C}/\text{W}$
Thermal resistance, junction to ambient	R_{thJA}	Typical socket mount		-	-	40	
Thermal resistance, case to heatsink	R_{thCS}			-	0.4	-	
Weight				-	6.0	-	g
				-	0.21	-	oz.
Mounting torque				6.0 (5)	-	12 (10)	kgf · cm (lbf · in)
Marking device		Case style TO-247AD 2L		E4PU3006L			

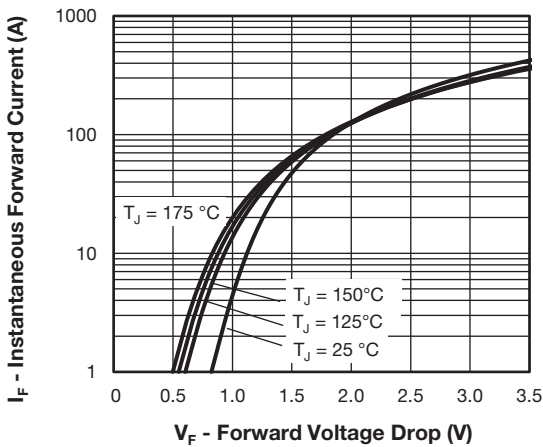

Fig. 1 - Typical Forward Voltage Drop Characteristics

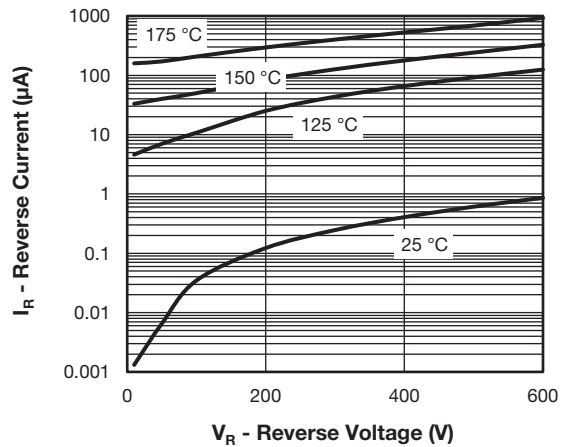

Fig. 2 - Typical Values of Reverse Current vs. Reverse Voltage

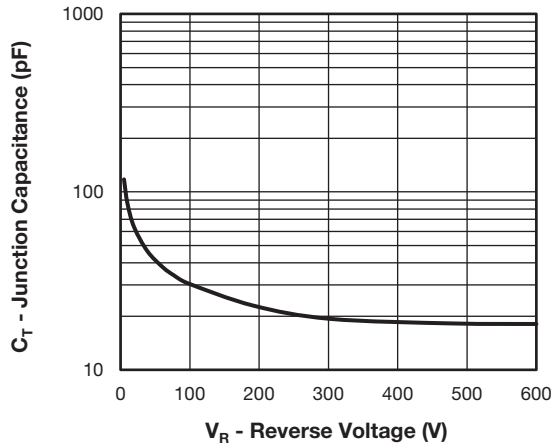

Fig. 3 - Typical Junction Capacitance vs. Reverse Voltage

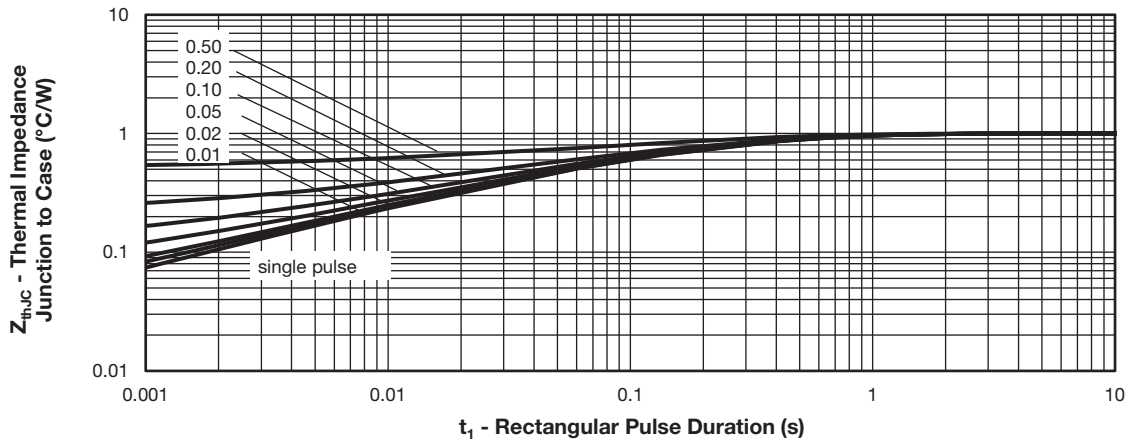

Fig. 4 - Max. Thermal Impedance Z_{thJC} Characteristics

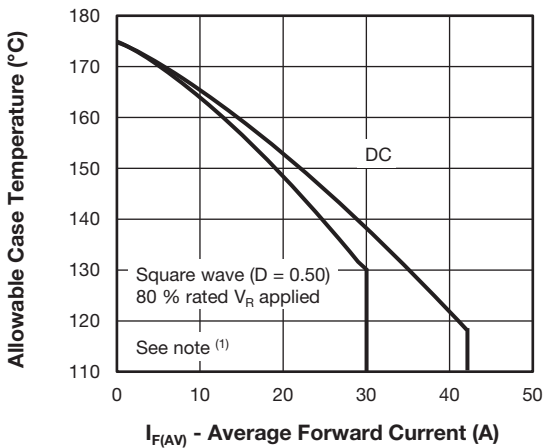

Fig. 5 - Maximum Allowable Case Temperature vs. Average Forward Current

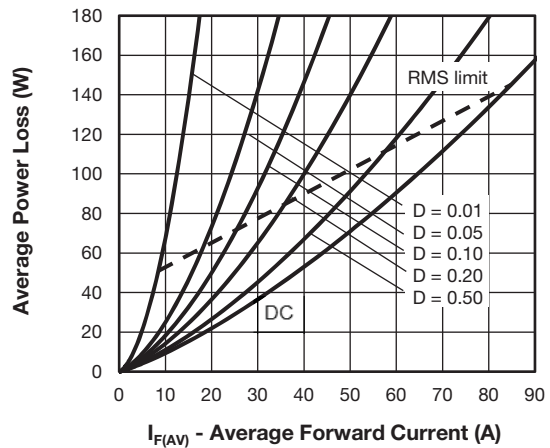

Fig. 6 - Forward Power Loss Characteristics

Note

- (1) Formula used: $T_C = T_J - (P_d + P_{dREV}) \times R_{thJC}$;
- P_d = forward power loss = $I_{F(AV)} \times V_{FM}$ at $(I_{F(AV)}/D)$ (see Fig.5)
- P_{dREV} = inverse power loss = $V_{R1} \times I_R (1 - D)$; I_R at V_R = rated V_R

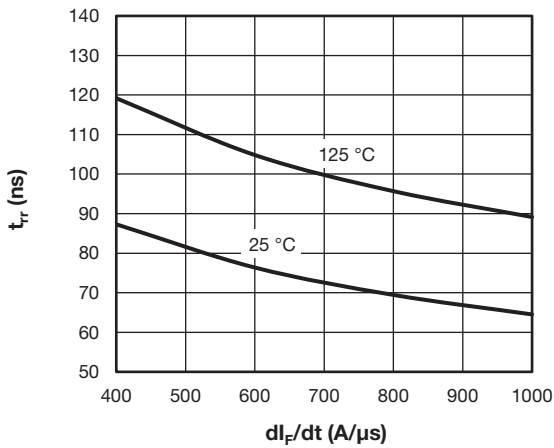

Fig. 7 - Typical Reverse Recovery Time vs. di_F/dt

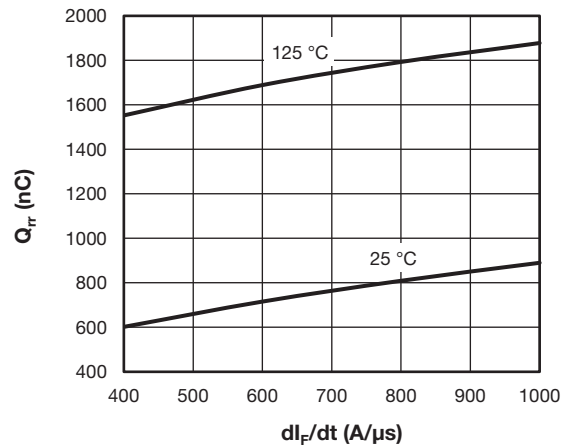

Fig. 8 - Typical Stored Charge vs. di_F/dt

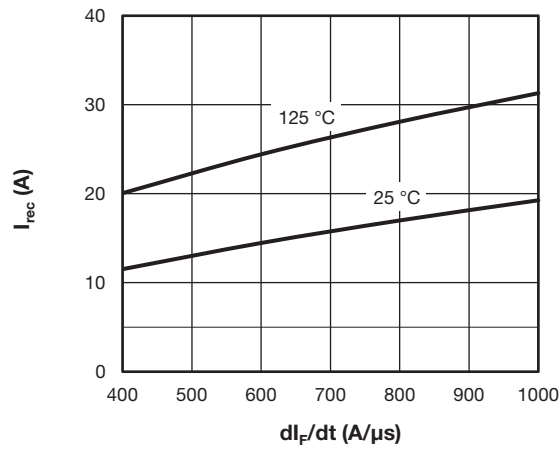
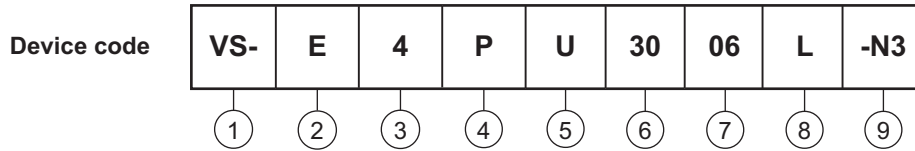

Fig. 9 - Typical Reverse Current vs. di_F/dt



ORDERING INFORMATION TABLE



- 1** - Vishay Semiconductors product
- 2** - Circuit configuration:
E = single diode
- 3** - FRED Pt Gen 4
- 4** - P = TO-247 package
- 5** - Process type:
U = ultrafast recovery
- 6** - Current rating (30 = 30 A)
- 7** - Voltage rating (06 = 600 V)
- 8** - Package: L = long lead
- 9** - Environmental digit:
-N3 = halogen-free, RoHS-compliant, and totally lead (Pb)-free

ORDERING INFORMATION (Example)			
PREFERRED P/N	QUANTITY PER TUBE	MINIMUM ORDER QUANTITY	PACKAGING DESCRIPTION
VS-E4PU3006L-N3	25	500	Antistatic plastic tube

LINKS TO RELATED DOCUMENTS	
Dimensions	www.vishay.com/doc?95536
Part marking information	www.vishay.com/doc?95648

TO-247AD 2L

DIMENSIONS in millimeters and inches

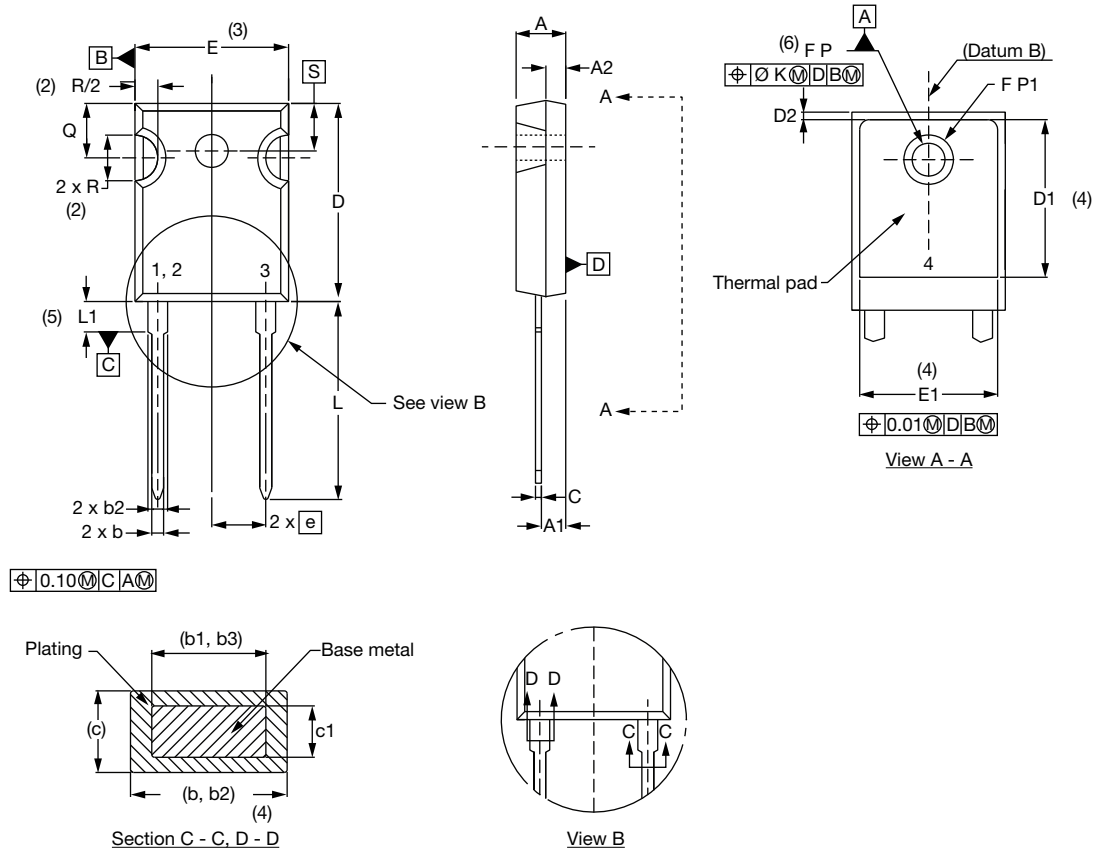

SYMBOL	MILLIMETERS		INCHES		NOTES	SYMBOL	MILLIMETERS		INCHES		NOTES
	MIN.	MAX.	MIN.	MAX.			MIN.	MAX.	MIN.	MAX.	
A	4.65	5.31	0.183	0.209		E	15.29	15.87	0.602	0.625	3
A1	2.21	2.59	0.087	0.102		E1	13.46	-	0.53	-	
A2	1.50	2.49	0.059	0.098		e	5.46 BSC		0.215 BSC		
b	0.99	1.40	0.039	0.055		Ø K	0.254		0.010		
b1	0.99	1.35	0.039	0.053		L	19.81	20.32	0.780	0.800	
b2	1.65	2.39	0.065	0.094		L1	3.71	4.29	0.146	0.169	
b3	1.65	2.34	0.065	0.092		Ø P	3.56	3.66	0.14	0.144	
c	0.38	0.89	0.015	0.035		Ø P1	-	6.98	-	0.275	
c1	0.38	0.84	0.015	0.033		Q	5.31	5.69	0.209	0.224	
D	19.71	20.70	0.776	0.815	3	R	4.52	5.49	0.178	0.216	
D1	13.08	-	0.515	-	4	S	5.51 BSC		0.217 BSC		
D2	0.51	1.35	0.020	0.053							

Notes

- (1) Dimensioning and tolerancing per ASME Y14.5M-1994
- (2) Contour of slot optional
- (3) Dimension D and E do not include mold flash. These dimensions are measured at the outermost extremes of the plastic body
- (4) Thermal pad contour optional with dimensions D1 and E1
- (5) Lead finish uncontrolled in L1
- (6) Ø P to have a maximum draft angle of 1.5 to the top of the part with a maximum hole diameter of 3.91 mm (0.154")
- (7) Outline conforms to JEDEC® outline TO-247 with exception of dimension A min., D, E min., Q min., S, and note 4



Disclaimer

ALL PRODUCT, PRODUCT SPECIFICATIONS AND DATA ARE SUBJECT TO CHANGE WITHOUT NOTICE TO IMPROVE RELIABILITY, FUNCTION OR DESIGN OR OTHERWISE.

Vishay Intertechnology, Inc., its affiliates, agents, and employees, and all persons acting on its or their behalf (collectively, "Vishay"), disclaim any and all liability for any errors, inaccuracies or incompleteness contained in any datasheet or in any other disclosure relating to any product.

Vishay makes no warranty, representation or guarantee regarding the suitability of the products for any particular purpose or the continuing production of any product. To the maximum extent permitted by applicable law, Vishay disclaims (i) any and all liability arising out of the application or use of any product, (ii) any and all liability, including without limitation special, consequential or incidental damages, and (iii) any and all implied warranties, including warranties of fitness for particular purpose, non-infringement and merchantability.

Statements regarding the suitability of products for certain types of applications are based on Vishay's knowledge of typical requirements that are often placed on Vishay products in generic applications. Such statements are not binding statements about the suitability of products for a particular application. It is the customer's responsibility to validate that a particular product with the properties described in the product specification is suitable for use in a particular application. Parameters provided in datasheets and / or specifications may vary in different applications and performance may vary over time. All operating parameters, including typical parameters, must be validated for each customer application by the customer's technical experts. Product specifications do not expand or otherwise modify Vishay's terms and conditions of purchase, including but not limited to the warranty expressed therein.

Except as expressly indicated in writing, Vishay products are not designed for use in medical, life-saving, or life-sustaining applications or for any other application in which the failure of the Vishay product could result in personal injury or death. Customers using or selling Vishay products not expressly indicated for use in such applications do so at their own risk. Please contact authorized Vishay personnel to obtain written terms and conditions regarding products designed for such applications.

No license, express or implied, by estoppel or otherwise, to any intellectual property rights is granted by this document or by any conduct of Vishay. Product names and markings noted herein may be trademarks of their respective owners.

X-ON Electronics

Largest Supplier of Electrical and Electronic Components

Click to view similar products for [Rectifiers](#) category:

Click to view products by [Vishay](#) manufacturer:

Other Similar products are found below :

[D91A](#) [DA24F4100L](#) [DD89N1600K-A](#) [DD89N16K-K](#) [RL252-TP](#) [DLA11C-TR-E](#) [DSA17G](#) [DSEI2X30-06C](#) [1N4005-TR](#) [BAV199-TP](#)
[UFS120Je3/TR13](#) [JANS1N6640US](#) [DD89N16K](#) [DD89N16K-A](#) [481235F](#) [DSP10G-TR-E](#) [067907F](#) [MS306](#) [ND104N08K](#) [SPA2003-B-D-](#)
[A01](#) [VGF0136AB](#) [US2JFL-TP](#) [UFS105Je3/TR13](#) [A1N5404G-G](#) [ACGRA4007-HF](#) [ACGRB207-HF](#) [RF301B2STL](#) [RF501B2STL](#) [UES1306](#)
[UES1302](#) [BAV199E6433HTMA1](#) [ACGRC307-HF](#) [ACEFC304-HF](#) [JANTXV1N5660A](#) [UES1106](#) [GS2K-LTP](#) [D126A45C](#) [D251N08B](#)
[SCHJ22.5K](#) [SM100](#) [SCPA2](#) [SCH10000](#) [SDHD5K](#) [STTH20P035FP](#) [VS-8EWS12S-M3](#) [VS-12FL100S10](#) [ACGRA4001-HF](#) [MUR420GP-TP](#)
[1N5404GP-E3/54](#) [ND89N08K](#)