

High Speed Infrared Emitting Diode, 940 nm, Surface Emitter Technology

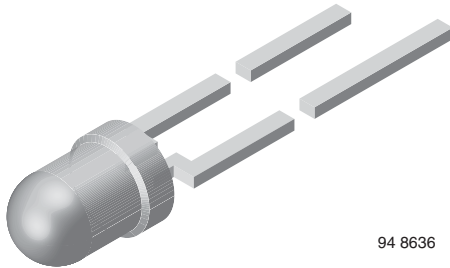

94 8636

DESCRIPTION

As part of the SurfLight™ portfolio, the VSLY3943 is a high speed infrared emitting diode based on surface emitter technology, molded in a blue-gray plastic package.

FEATURES

- Package type: leaded
- Package form: T-1, clear epoxy
- Dimensions: Ø 3 mm
- Peak wavelength: $\lambda_p = 940$ nm
- High speed
- High radiant power
- High radiant intensity
- Angle of half intensity: $\phi = \pm 17^\circ$
- Low forward voltage
- Good spectral matching to Si photodetectors
- Material categorization: for definitions of compliance please see www.vishay.com/doc?99912



APPLICATIONS

- Infrared remote control units
- Free air transmission systems
- Infrared source for optical counters and card readers

PRODUCT SUMMARY

COMPONENT	I_e (mW/sr)	ϕ (deg)	λ_p (nm)	t_r (ns)
VSLY3943	70	± 17	940	5

Note

- Test conditions see table “Basic Characteristics”

ORDERING INFORMATION

ORDERING CODE	PACKAGING	REMARKS	PACKAGE FORM
VSLY3943	Bulk	MOQ: 5000 pcs, 5000 pcs/bulk	T-1
VSLY3943-MSZ	Ammopack	MOQ: 10 000 pcs, 2000 pcs/box	T-1

Note

- MOQ: minimum order quantity

ABSOLUTE MAXIMUM RATINGS ($T_{amb} = 25$ °C, unless otherwise specified)

PARAMETER	TEST CONDITION	SYMBOL	VALUE	UNIT
Reverse voltage		V_R	5	V
Forward current		I_F	70	mA
Peak forward current	$t_p/T = 0.1, t_p = 100$ μ s	I_{FM}	140	mA
Surge forward current	$t_p = 100$ μ s	I_{FSM}	500	mA
Power dissipation		P_V	160	mW
Junction temperature		T_j	100	°C
Operating temperature range		T_{amb}	-40 to +85	°C
Storage temperature range		T_{stg}	-40 to +100	°C
Soldering temperature	$t \leq 5$ s, 2 mm from case	T_{sd}	260	°C
Thermal resistance junction-to-ambient	J-STD-051, leads 7 mm, soldered on PCB	R_{thJA}	300	K/W

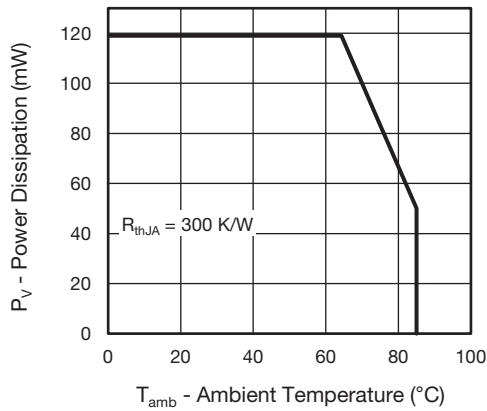

Fig. 1 - Power Dissipation Limit vs. Ambient Temperature

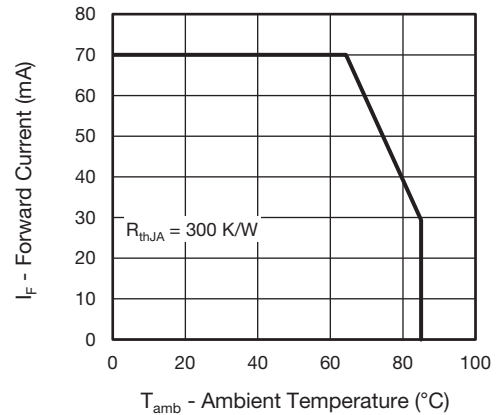

Fig. 2 - Forward Current Limit vs. Ambient Temperature

BASIC CHARACTERISTICS (T _{amb} = 25 °C, unless otherwise specified)						
PARAMETER	TEST CONDITION	SYMBOL	MIN.	TYP.	MAX.	UNIT
Forward voltage	I _F = 70 mA, t _p = 20 ms	V _F	-	1.5	1.7	V
	I _F = 500 mA, t _p = 100 μs	V _F	-	2.6	-	V
Temperature coefficient of V _F	I _F = 50 mA	TK _{V_F}	-	-0.7	-	mV/K
Reverse current	V _R = 5 V	I _R	Not designed for reverse operation			μA
Junction capacitance	V _R = 0 V, f = 1 MHz, E = 0 mW/cm ²	C _J	-	30	-	pF
Radiant intensity	I _F = 70 mA, t _p = 20 ms	I _e	32	70	120	mW/sr
	I _F = 500 mA, t _p = 100 μs	I _e	-	650	-	mW/sr
Radiant power	I _F = 70 mA, t _p = 20 ms	φ _e	-	40	-	mW
Temperature coefficient of radiant power	I _F = 50 mA	TK _{φ_e}	-	-0.2	-	%/K
Angle of half intensity		φ	-	± 17	-	deg
Peak wavelength	I _F = 50 mA	λ _p	-	940	-	nm
Spectral bandwidth	I _F = 70 mA	Δλ	-	55	-	nm
Temperature coefficient of λ _p	I _F = 70 mA	TK _{λ_p}	-	0.28	-	nm
Rise time	I _F = 70 mA, 10 % to 90 %	t _r	-	5	-	ns
Fall time	I _F = 70 mA, 10 % to 90 %	t _f	-	6	-	ns

BASIC CHARACTERISTICS ($T_{amb} = 25\text{ }^{\circ}\text{C}$, unless otherwise specified)

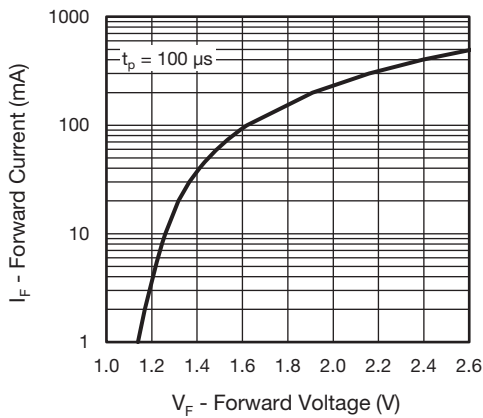

Fig. 3 - Forward Current vs. Forward Voltage

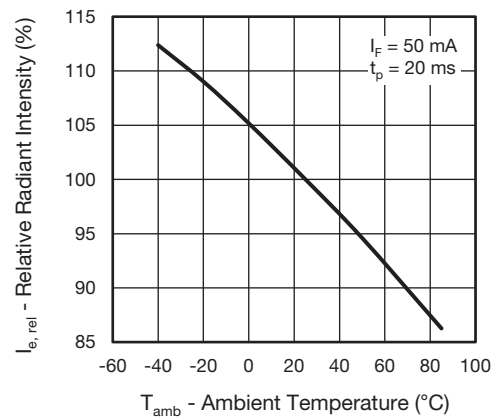

Fig. 6 - Relative Radiant Intensity vs. Ambient Temperature

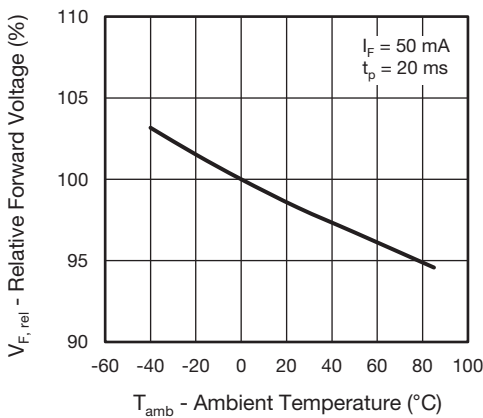

Fig. 4 - Relative Forward Voltage vs. Ambient Temperature

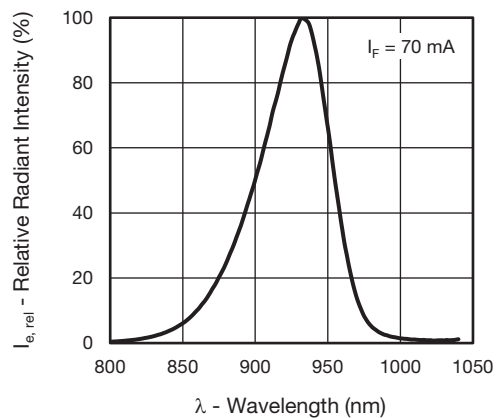

Fig. 7 - Relative Radiant Intensity vs. Wavelength

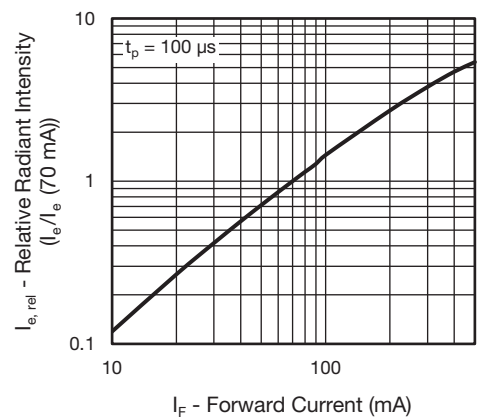

Fig. 5 - Relative Radiant Intensity vs. Forward Current

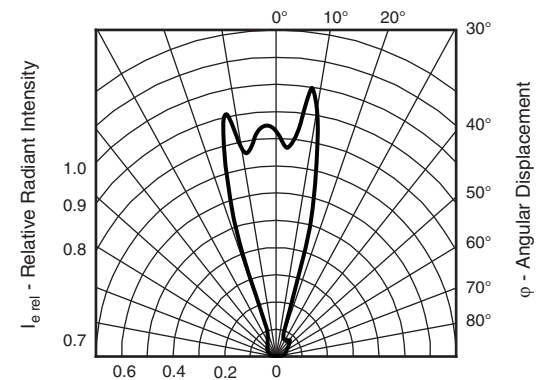
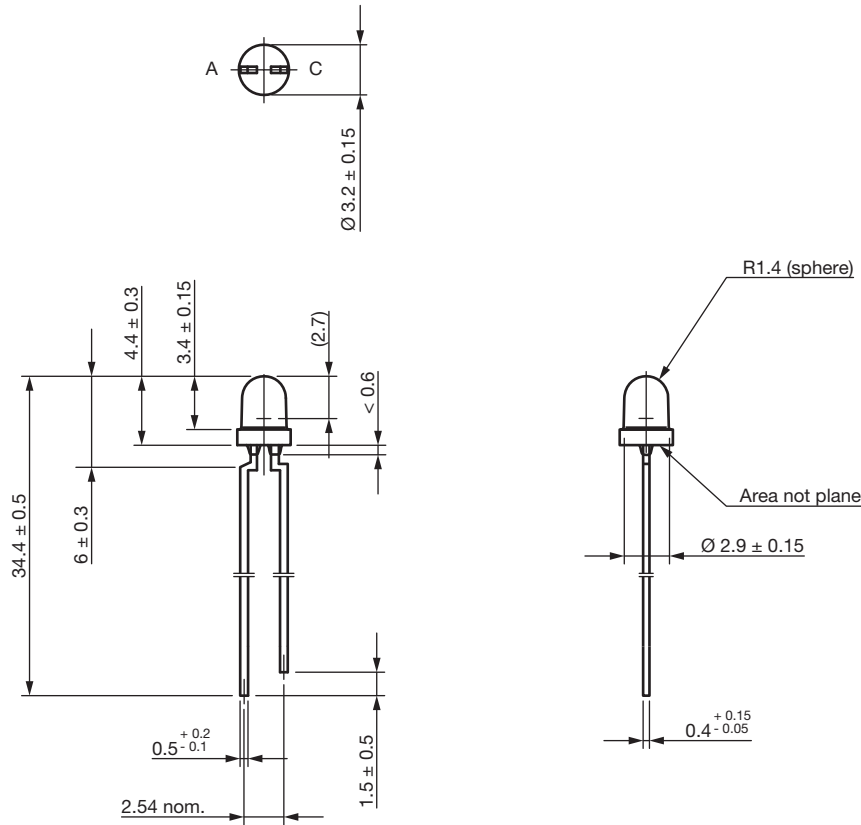
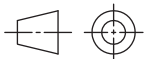

Fig. 8 - Relative Radiant Intensity vs. Angular Displacement



PACKAGE DIMENSIONS in millimeters



technical drawings
according to DIN
specifications

Drawing-No.: 6.541-5118.01-4
Issue: 1; 13.12.17



Disclaimer

ALL PRODUCT, PRODUCT SPECIFICATIONS AND DATA ARE SUBJECT TO CHANGE WITHOUT NOTICE TO IMPROVE RELIABILITY, FUNCTION OR DESIGN OR OTHERWISE.

Vishay Intertechnology, Inc., its affiliates, agents, and employees, and all persons acting on its or their behalf (collectively, "Vishay"), disclaim any and all liability for any errors, inaccuracies or incompleteness contained in any datasheet or in any other disclosure relating to any product.

Vishay makes no warranty, representation or guarantee regarding the suitability of the products for any particular purpose or the continuing production of any product. To the maximum extent permitted by applicable law, Vishay disclaims (i) any and all liability arising out of the application or use of any product, (ii) any and all liability, including without limitation special, consequential or incidental damages, and (iii) any and all implied warranties, including warranties of fitness for particular purpose, non-infringement and merchantability.

Statements regarding the suitability of products for certain types of applications are based on Vishay's knowledge of typical requirements that are often placed on Vishay products in generic applications. Such statements are not binding statements about the suitability of products for a particular application. It is the customer's responsibility to validate that a particular product with the properties described in the product specification is suitable for use in a particular application. Parameters provided in datasheets and / or specifications may vary in different applications and performance may vary over time. All operating parameters, including typical parameters, must be validated for each customer application by the customer's technical experts. Product specifications do not expand or otherwise modify Vishay's terms and conditions of purchase, including but not limited to the warranty expressed therein.

Except as expressly indicated in writing, Vishay products are not designed for use in medical, life-saving, or life-sustaining applications or for any other application in which the failure of the Vishay product could result in personal injury or death. Customers using or selling Vishay products not expressly indicated for use in such applications do so at their own risk. Please contact authorized Vishay personnel to obtain written terms and conditions regarding products designed for such applications.

No license, express or implied, by estoppel or otherwise, to any intellectual property rights is granted by this document or by any conduct of Vishay. Product names and markings noted herein may be trademarks of their respective owners.

X-ON Electronics

Largest Supplier of Electrical and Electronic Components

Click to view similar products for [Infrared Emitters - High Power](#) category:

Click to view products by [Vishay](#) manufacturer:

Other Similar products are found below :

[TSHA6201](#) [TSHA6202](#) [SFH 4030](#) [SFH 4060](#) [SFH 4775S A01](#) [SFH 4726AS](#) [SFH 4725AS](#) [VSMY2853SLX01](#) [VSMY2853RGX01](#)
[VSMY2853GX01](#) [VSMY2850GX01](#) [IN-P281ASGHIR](#) [IN-P281ASGIR](#) [VSMY2890GX01](#) [VSMY2890RGX01](#) [SFH 4728AS A01](#) [SST-10-
IRD-B130H-S940](#) [SST-10-IRD-B50H-S940](#) [QEE123](#) [TSHA6200](#) [TSML1030](#) [VTE1291W-2H](#) [LL-304IRC4B-2AD](#) [LL-503HIRT2E-1CC](#)
[LL-503IRC2E-2AC](#) [LL-503IRC2V-2AD](#) [LL-503IRT2E-2AC](#) [LL-503IRT2E-2AE](#) [LL-503SIRC2E-1BD](#) [LL-S170IRC-2A](#) [SFH 4259](#)
[OS5RKAZ5D1P](#) [OSB56LZE31D](#) [OSG58AZ5D1P](#) [OSI3CA5111A](#) [OSI3NAS1C1A](#) [OSI5LA56A1A](#) [OSI5XNE3E1E](#) [OSIXCA5121A](#)
[OSIXCAS1C1A](#) [OSM54LZ5D1P](#) [OSM5D3Z2C1P](#) [OSMR43Z2C1P](#) [OSO5PAZ161D](#) [OSOR7161D](#) [OSPW7161D](#) [OSPW71B1P](#)
[OSR5PAZE31D](#) [OSR9XAE3E1E](#) [OSRICA3131A](#)