

## High Power Infrared Emitting Diode, 850 nm, Surface Emitter Technology



### LINKS TO ADDITIONAL RESOURCES



### DESCRIPTION

As part of the [SurfLight™](#) portfolio, the VSMA1085400 is an infrared, 850 nm emitting diode. It features a double stack emitter chip for highest radiant power. The 42 mil chip size allows 1.5 A DC operation and supports pulsed currents up to 5.0 A.

### FEATURES

- Package type: surface-mount
- Package form: high power SMD with lens
- Dimensions (L x W x H in mm): 3.4 x 3.4 x 2.45
- Centroid wavelength:  $\lambda_{\text{centroid}} = 850 \text{ nm}$
- Angle of half intensity:  $\varphi = \pm 40^\circ$
- Designed for high drive currents: up to 1.5 A (DC) and up to 5 A (pulsed)
- Low thermal resistance:  $6 \text{ K/W} < R_{\text{thJSP}} < 9 \text{ K/W}$
- ESD: up to 5 kV (according to ANSI / ESDA / JEDEC® JS-001)
- Floor life: 168 h, MSL 3, according to J-STD-020
- Lead (Pb)-free reflow soldering
- Material categorization: for definitions of compliance please see [www.vishay.com/doc?99912](http://www.vishay.com/doc?99912)



### APPLICATIONS

- Driver and occupant monitoring
- Eye tracking
- Safety and security, CCTV

### PRODUCT SUMMARY

COMPONENT	$I_e$ (mW/sr) at $I_F = 1.0 \text{ A}$	$\varphi$ (°)	$\lambda_p$ (nm)	$\lambda_{\text{centroid}}$ (nm)	$t_r$ (ns)
VSMA1085400	925	$\pm 40$	860	850	10

#### Note

- Test conditions see table “Basic Characteristics”

### ORDERING INFORMATION

ORDERING CODE	PACKAGING	REMARKS	PACKAGE FORM
VSMA1085400	Tape and reel	MOQ: 600 pcs, 600 pcs/reel	High power with lens

#### Note

- MOQ: minimum order quantity

<b>ABSOLUTE MAXIMUM RATINGS</b> ( $T_{amb} = 25\text{ }^{\circ}\text{C}$ , unless otherwise specified)				
PARAMETER	TEST CONDITION	SYMBOL	VALUE	UNIT
Reverse voltage		$V_R$	5	V
Forward current		$I_F$	1.5	A
Surge forward current	$t_p = 100\text{ }\mu\text{s}$	$I_{FSM}$	5	A
Power dissipation		$P_V$	5.33	W
Junction temperature		$T_j$	145	$^{\circ}\text{C}$
Ambient temperature range		$T_{amb}$	-40 to +125	$^{\circ}\text{C}$
Storage temperature range		$T_{stg}$	-40 to +125	$^{\circ}\text{C}$
Soldering temperature	According to Fig. 11, J-STD020E	$T_{sd}$	260	$^{\circ}\text{C}$
Thermal resistance junction to solder point real <sup>(1)</sup>	JESD 51	$R_{thJSP,real}$	6 to 9	K/W
Thermal resistance junction to ambient real	JESD 51	$R_{thJA,real}$	150	K/W
ESD sensitivity	According to ANSI / ESDA / JEDEC JS-001	$V_{ESD}$	5	kV

**Note**

- (1) Thermal resistance junction to solder point real has been measured with the part mounted on an ideal heatsink and the optical output power has been deducted from the total electrical power dissipation

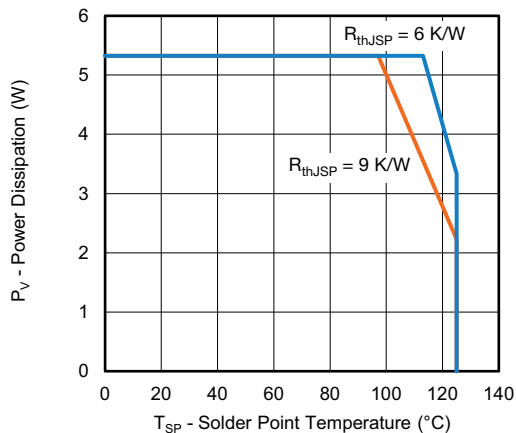


Fig. 1 - Power Dissipation Limit vs. Solder Point Temperature

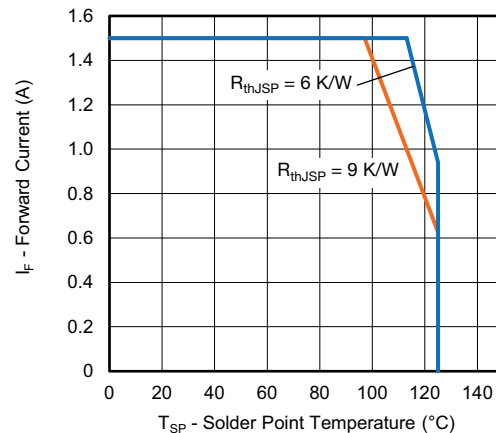


Fig. 2 - Forward Current Limit vs. Solder Point Temperature

<b>BASIC CHARACTERISTICS</b> ( $T_{amb} = 25\text{ }^{\circ}\text{C}$ , unless otherwise specified)						
PARAMETER	TEST CONDITION	SYMBOL	MIN.	TYP.	MAX.	UNIT
Forward voltage	$I_F = 0.35\text{ A}$ , $t_p = 10\text{ ms}$	$V_F$	2.7	2.95	3.1	V
	$I_F = 1\text{ A}$ , $t_p = 100\text{ }\mu\text{s}$	$V_F$	2.8	3.1	3.3	V
	$I_F = 1.5\text{ A}$ , $t_p = 100\text{ }\mu\text{s}$	$V_F$	2.9	3.25	3.55	V
	$I_F = 5\text{ A}$ , $t_p = 100\text{ }\mu\text{s}$	$V_F$	3.2	3.9	4.4	V
Temperature coefficient of $V_F$	$I_F = 1\text{ A}$ , $t_p = 200\text{ }\mu\text{s}$		-	-2	-	mV/K
Reverse current		$I_R$	Not designed for reverse operation			$\mu\text{A}$
Radiant intensity	$I_F = 0.35\text{ A}$ , $t_p = 10\text{ ms}$	$I_e$	275	350	425	mW/sr
	$I_F = 1\text{ A}$ , $t_p = 100\text{ }\mu\text{s}$	$I_e$	700	925	1150	mW/sr
	$I_F = 1.5\text{ A}$ , $t_p = 100\text{ }\mu\text{s}$	$I_e$	975	1350	1725	mW/sr
	$I_F = 5\text{ A}$ , $t_p = 100\text{ }\mu\text{s}$	$I_e$	2850	4100	5350	mW/sr
Radiant power	$I_F = 1\text{ A}$ , $t_p = 100\text{ }\mu\text{s}$	$\phi_e$	-	1425	-	mW
	$I_F = 1.5\text{ A}$ , $t_p = 100\text{ }\mu\text{s}$	$\phi_e$	-	2100	-	mW
Temperature coefficient of $\phi$	$I_F = 1\text{ A}$ , $t_p = 200\text{ }\mu\text{s}$	$TK_{\phi}$	-	-0.15	-	%/K
Angle of half intensity		$\varphi$	-	$\pm 40$	-	$^{\circ}$
Peak wavelength	$I_F = 1\text{ A}$ , $t_p = 300\text{ }\mu\text{s}$	$\lambda_p$	-	860	-	nm
Centroid wavelength	$I_F = 1\text{ A}$ , $t_p = 300\text{ }\mu\text{s}$	$\lambda_{\text{centroid}}$	-	850	-	nm
Spectral bandwidth	$I_F = 1\text{ A}$ , $t_p = 300\text{ }\mu\text{s}$	$\Delta\lambda$	-	30	-	nm
Temperature coefficient of $\lambda_p$	$I_F = 100\text{ mA}$ , $t_p = 20\text{ ms}$	$TK_{\lambda_p}$	-	0.25	-	nm/K
Rise time	$I_F = 1\text{ A}$	$t_r$	-	10	-	ns
Fall time	$I_F = 1\text{ A}$	$t_f$	-	15	-	ns

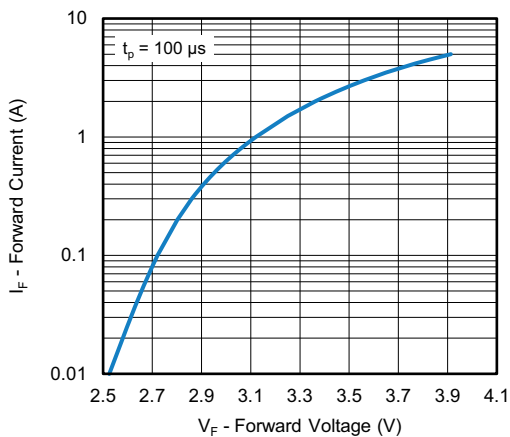
**BASIC CHARACTERISTICS** ( $T_{amb} = 25\text{ }^{\circ}\text{C}$ , unless otherwise specified)


Fig. 3 - Forward Current vs. Forward Voltage

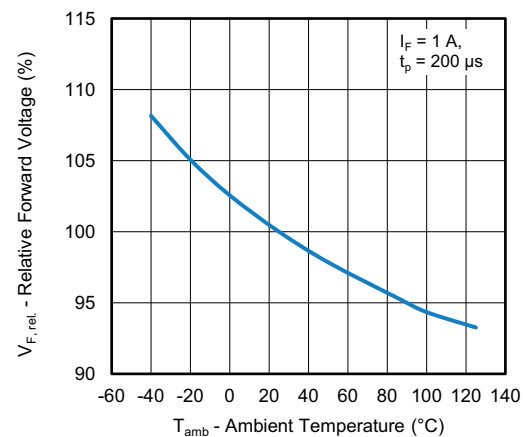


Fig. 4 - Relative Forward Voltage vs. Ambient Temperature

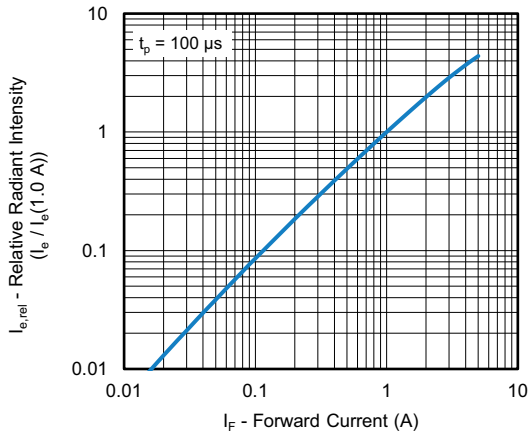


Fig. 5 - Relative Radiant Intensity vs. Forward Current

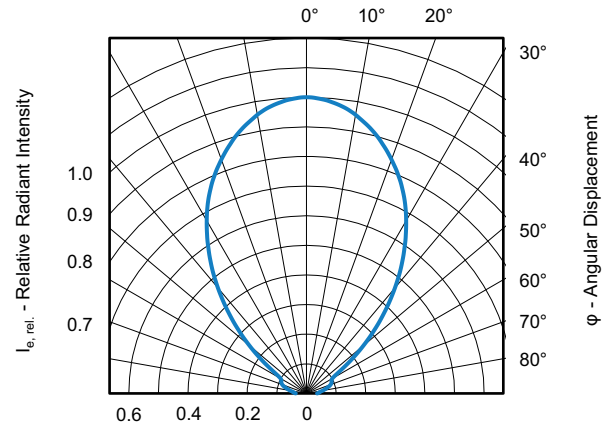


Fig. 8 - Relative Radiant Intensity vs. Angular Displacement

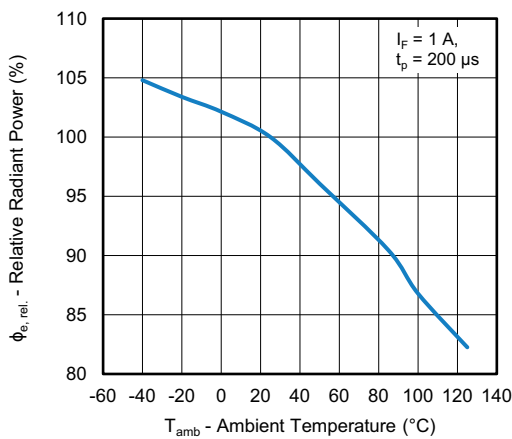


Fig. 6 - Relative Radiant Power vs. Ambient Temperature

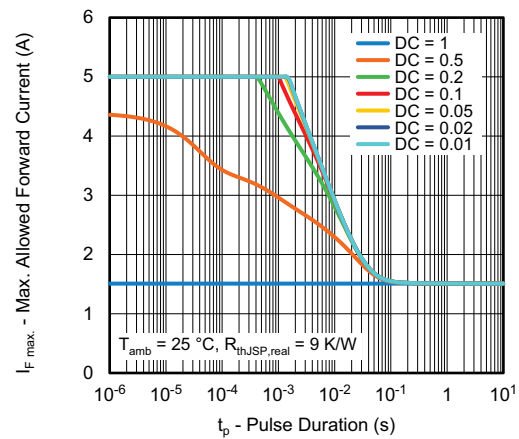


Fig. 9 - Max. Allowed Forward Current vs. Pulse Duration

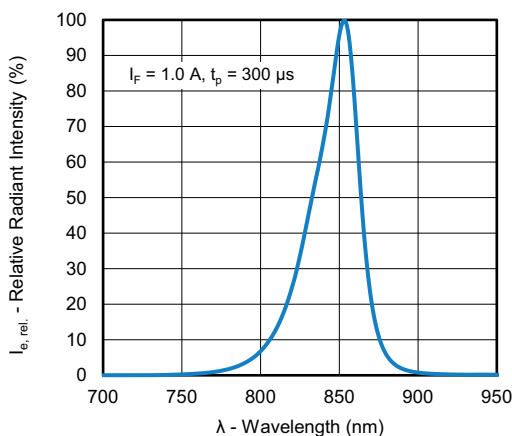


Fig. 7 - Relative Radiant Intensity vs. Wavelength

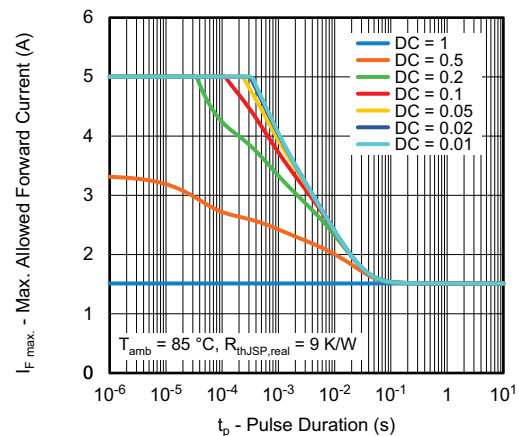
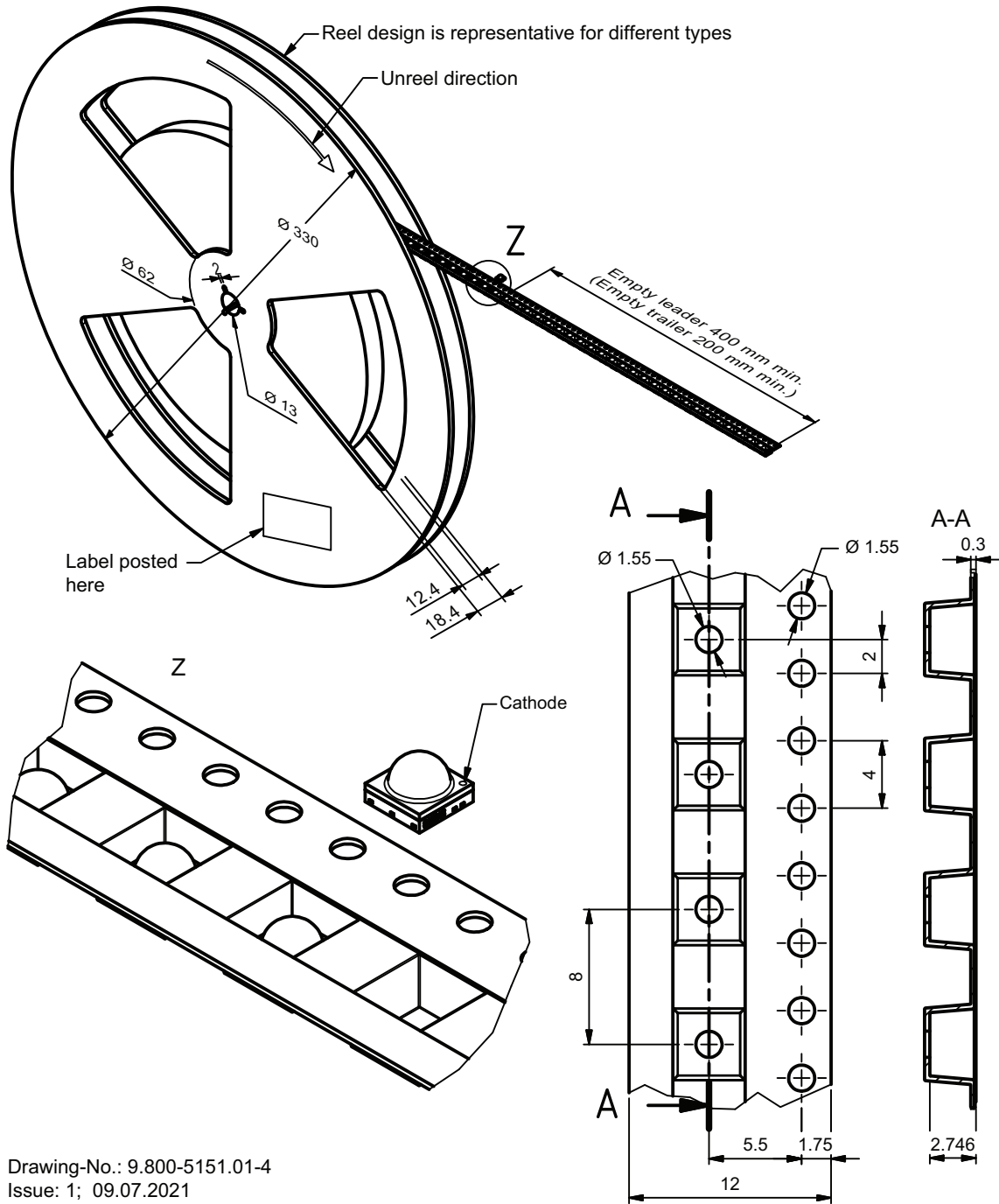


Fig. 10 - Max. Allowed Forward Current vs. Pulse Duration

**TAPING DIMENSIONS** in millimeters



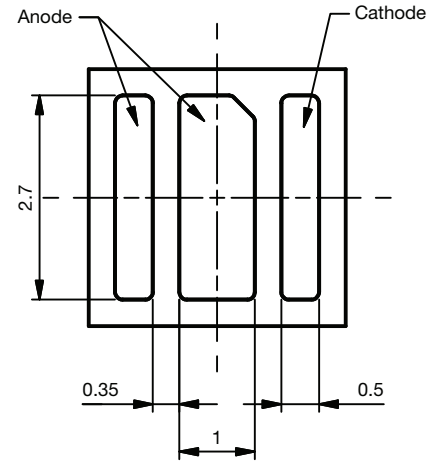
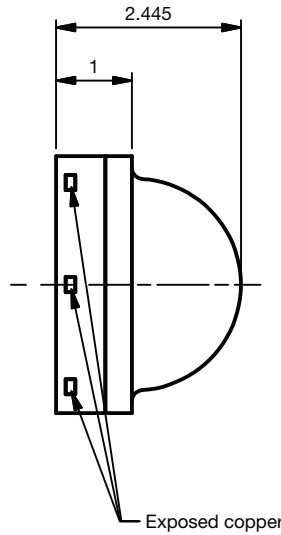
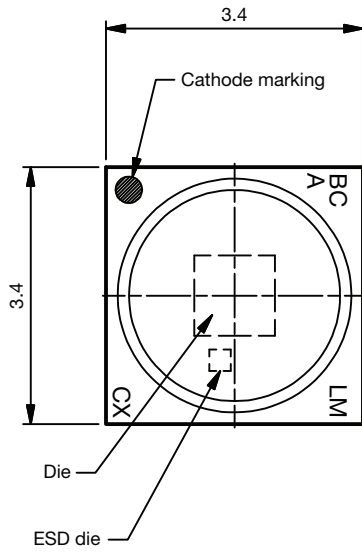
Drawing-No.: 9.800-5151.01-4  
Issue: 1; 09.07.2021

**Notes**

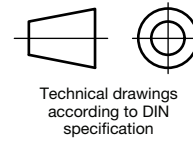
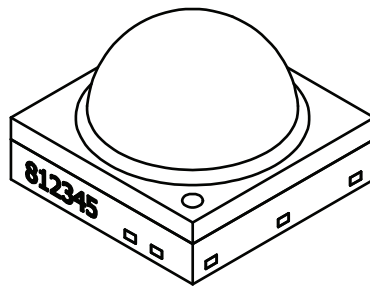
- Empty component pockets sealed with top cover tape
- 7 inch reel - 600 pieces per reel
- The maximum number of consecutive missing lamps is two
- In accordance with ANSI / EIA 481-1-A-1994 specifications



PACKAGE DIMENSIONS in millimeters



Not indicated tolerances ± 0.1



Technical drawings according to DIN specification

Drawing-No.: 6.550-5367.01-4  
Issue: 1; 09.07.2021

Notes

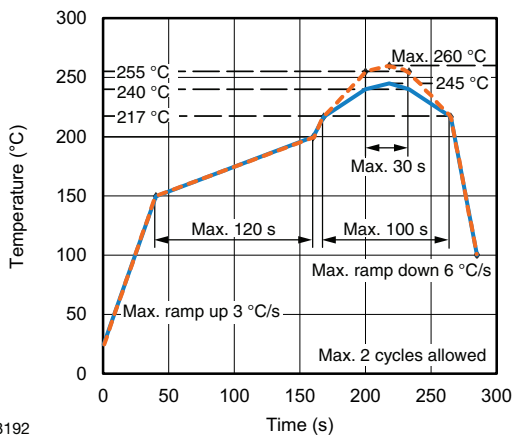
- Tolerance is ± 0.10 mm (0.004") unless otherwise noted
- Specifications are subject to change without notice

**RECOMMENDED FOOTPRINT**



Drawing-No.: 6.550-5366.9-3  
Issue: 1; 09.07.2021

**SOLDER PROFILE**



23192

Fig. 11 - Lead (Pb)-free (Sn) Infrared Reflow Solder Profile According to J-STD020E for Surface-Mount Components

**DRYPACK**

Devices are packed in moisture barrier bags (MBB) to prevent the products from moisture absorption during transportation and storage. Each bag contains a desiccant.

**FLOOR LIFE**

Floor life (time between soldering and removing from MBB) must not exceed the time indicated on MBB label:

Floor life: 168 h

Conditions:  $T_{amb} < 30\text{ °C}$ ,  $RH < 60\%$

Moisture sensitivity level 3, according to J-STD-020B

**DRYING**

In case of moisture absorption devices should be baked before soldering. Conditions see J-STD-033D or label. Devices taped on reel dry using recommended conditions 192 h at 40 °C (+ 5 °C),  $RH < 5\%$ .



## Disclaimer

ALL PRODUCT, PRODUCT SPECIFICATIONS AND DATA ARE SUBJECT TO CHANGE WITHOUT NOTICE TO IMPROVE RELIABILITY, FUNCTION OR DESIGN OR OTHERWISE.

Vishay Intertechnology, Inc., its affiliates, agents, and employees, and all persons acting on its or their behalf (collectively, "Vishay"), disclaim any and all liability for any errors, inaccuracies or incompleteness contained in any datasheet or in any other disclosure relating to any product.

Vishay makes no warranty, representation or guarantee regarding the suitability of the products for any particular purpose or the continuing production of any product. To the maximum extent permitted by applicable law, Vishay disclaims (i) any and all liability arising out of the application or use of any product, (ii) any and all liability, including without limitation special, consequential or incidental damages, and (iii) any and all implied warranties, including warranties of fitness for particular purpose, non-infringement and merchantability.

Statements regarding the suitability of products for certain types of applications are based on Vishay's knowledge of typical requirements that are often placed on Vishay products in generic applications. Such statements are not binding statements about the suitability of products for a particular application. It is the customer's responsibility to validate that a particular product with the properties described in the product specification is suitable for use in a particular application. Parameters provided in datasheets and / or specifications may vary in different applications and performance may vary over time. All operating parameters, including typical parameters, must be validated for each customer application by the customer's technical experts. Product specifications do not expand or otherwise modify Vishay's terms and conditions of purchase, including but not limited to the warranty expressed therein.

Hyperlinks included in this datasheet may direct users to third-party websites. These links are provided as a convenience and for informational purposes only. Inclusion of these hyperlinks does not constitute an endorsement or an approval by Vishay of any of the products, services or opinions of the corporation, organization or individual associated with the third-party website. Vishay disclaims any and all liability and bears no responsibility for the accuracy, legality or content of the third-party website or for that of subsequent links.

Except as expressly indicated in writing, Vishay products are not designed for use in medical, life-saving, or life-sustaining applications or for any other application in which the failure of the Vishay product could result in personal injury or death. Customers using or selling Vishay products not expressly indicated for use in such applications do so at their own risk. Please contact authorized Vishay personnel to obtain written terms and conditions regarding products designed for such applications.

No license, express or implied, by estoppel or otherwise, to any intellectual property rights is granted by this document or by any conduct of Vishay. Product names and markings noted herein may be trademarks of their respective owners.



## X-ON Electronics

Largest Supplier of Electrical and Electronic Components

*Click to view similar products for [Infrared Emitters](#) category:*

*Click to view products by [Vishay](#) manufacturer:*

Other Similar products are found below :

[LTE-309](#) [LTE-3279K](#) [LTE-4206C](#) [LTE-4208C](#) [EAILP03RDAA6](#) [IR333C](#) [LTE-2871C](#) [LTE-4238](#) [ASDL-4264-C22](#) [OED-EL305F4C50-HT](#)  
[OP216-004](#) [LTE-3376](#) [EEL109](#) [SFH 7016](#) [SFH 7015](#) [IN-S126ETIR](#) [IN-S126DSHIR](#) [IN-S126ETHIR](#) [IN-P32ZTHIR](#) [IN-S42CTQHIR](#) [IN-](#)  
[S126BTHIR](#) [IN-S63DTHIR](#) [IN-S85BTHIR](#) [IN-S63FTHIR](#) [EAIST3535A4](#) [MHT153IRCT](#) [IR533C](#) [NTE30116](#) [RE30A6-IRT-FS](#) [RE30A6-](#)  
[IRX-FS](#) [RE30AX-IRT-FS](#) [RE30AX-IRX-FS](#) [RF-E30A3-IRX-FS](#) [RF-E30A5-IRT-FS](#) [RF-E30AX-IRT-FS](#) [RF-P28A3-IRN-FT](#) [RF-P28A6-](#)  
[IRN-FT](#) [RF-P42D6-IPJ-FT](#) [RF-P42D6-IPL-FT](#) [RF-P43D6-IPL-FT](#) [RF-P43D6-IPN-FT](#) [HIR204C/H0](#) [HIR323C](#) [LTE-209](#) [HSDL-4400#011](#)  
[IR12-21C/TR8](#) [IR17-21C/TR8](#) [IR26-21C/L110/TR8](#) [IR91-21C/TR10](#) [KM-4457F3C](#)