

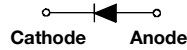

## High Performance Schottky Rectifier, 1.0 A



SMB (DO-214AA)



### FEATURES

- Small foot print, surface mountable
- Low forward voltage drop
- High frequency operation
- Guard ring for enhanced ruggedness and long term reliability
- Meets MSL level 1, per J-STD-020, LF maximum peak of 260 °C
- Material categorization: for definitions of compliance please see [www.vishay.com/doc?99912](http://www.vishay.com/doc?99912)



RoHS COMPLIANT HALOGEN FREE

### PRIMARY CHARACTERISTICS

$I_{F(AV)}$	1 A
$V_R$	90 V, 100 V
$V_F$ at $I_F$	0.78 V
$I_{RM}$	1 mA at 125 °C
$T_J$ max.	175 °C
$E_{AS}$	1.0 mJ
Package	SMB (DO-214AA)
Circuit configuration	Single

### DESCRIPTION

The VS-MBRS190-M3, VS-MBRS1100-M3 surface-mount Schottky rectifier has been designed for applications requiring low forward drop and very small foot prints on PC boards. Typical applications are in disk drives, switching power supplies, converters, freewheeling diodes, battery charging, and reverse battery protection.

### MAJOR RATINGS AND CHARACTERISTICS

SYMBOL	CHARACTERISTICS	VALUES	UNITS
$I_{F(AV)}$	Rectangular waveform	1.0	A
$V_{RRM}$		90, 100	V
$I_{FSM}$	$t_p = 5 \mu s$ sine	870	A
$V_F$	1.0 A <sub>pk</sub> , $T_J = 125 \text{ °C}$	0.63	V
$T_J$	Range	-55 to +175	°C

### VOLTAGE RATINGS

PARAMETER	SYMBOL	VS-MBRS190-M3	VS-MBRS1100-M3	UNITS
Maximum DC reverse voltage	$V_R$	90	100	V
Maximum working peak reverse voltage	$V_{RWM}$			

### ABSOLUTE MAXIMUM RATINGS

PARAMETER	SYMBOL	TEST CONDITIONS	VALUES	UNITS
Maximum average forward current	$I_{F(AV)}$	50 % duty cycle at $T_L = 147 \text{ °C}$ , rectangular waveform	1.0	A
Maximum peak one cycle non-repetitive surge current	$I_{FSM}$	5 $\mu s$ sine or 3 $\mu s$ rect. pulse	870	
		10 ms sine or 6 ms rect. pulse	50	
Non-repetitive avalanche energy	$E_{AS}$	$T_J = 25 \text{ °C}$ , $I_{AS} = 0.5 \text{ A}$ , $L = 8 \text{ mH}$	1.0	mJ
Repetitive avalanche current	$I_{AR}$	Current decaying linearly to zero in 1 $\mu s$ Frequency limited by $T_J$ maximum $V_A = 1.5 \times V_R$ typical	0.5	A



ELECTRICAL SPECIFICATIONS					
PARAMETER	SYMBOL	TEST CONDITIONS		VALUES	UNITS
Maximum forward voltage drop See fig. 1	$V_{FM}^{(1)}$	1 A	$T_J = 25\text{ }^\circ\text{C}$	0.78	V
			$T_J = 125\text{ }^\circ\text{C}$	0.62	
Maximum reverse leakage current See fig. 2	$I_{RM}^{(1)}$	$T_J = 25\text{ }^\circ\text{C}$ $T_J = 125\text{ }^\circ\text{C}$	$V_R = \text{Rated } V_R$	0.5	mA
				1.0	
Typical junction capacitance	$C_T$	$V_R = 5\text{ }V_{DC}$ (test signal range 100 kHz to 1 MHz) $25\text{ }^\circ\text{C}$		42	pF
Typical series inductance	$L_S$	Measured lead to lead 5 mm from package body		2.0	nH
Maximum voltage rate of change	$dV/dt$	Rated $V_R$		10 000	V/ $\mu\text{s}$

**Note**(1) Pulse width < 300  $\mu\text{s}$ , duty cycle < 2 %

THERMAL - MECHANICAL SPECIFICATIONS					
PARAMETER	SYMBOL	TEST CONDITIONS		VALUES	UNITS
Maximum junction and storage temperature range	$T_J^{(1)}, T_{Stg}$			-55 to +175	$^\circ\text{C}$
Maximum thermal resistance, junction to lead	$R_{thJL}^{(2)}$	DC operation See fig. 4		36	$^\circ\text{C}/\text{W}$
Maximum thermal resistance, junction to ambient	$R_{thJA}$	DC operation		80	
Approximate weight				0.10	g
				0.003	oz.
Marking device		Case style SMB (DO-214AA)		19/10	

**Notes**(1)  $\frac{dP_{tot}}{dT} < \frac{1}{R_{thJA}}$  thermal runaway condition for a diode on its own heatsink

(2) Mounted 1 square PCB

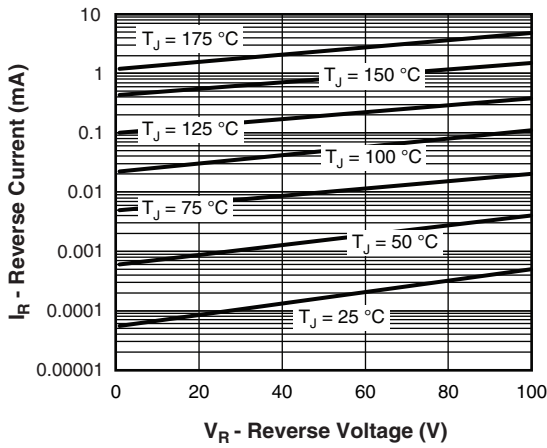

Fig. 1 - Typical Peak Reverse Current vs. Reverse Voltage

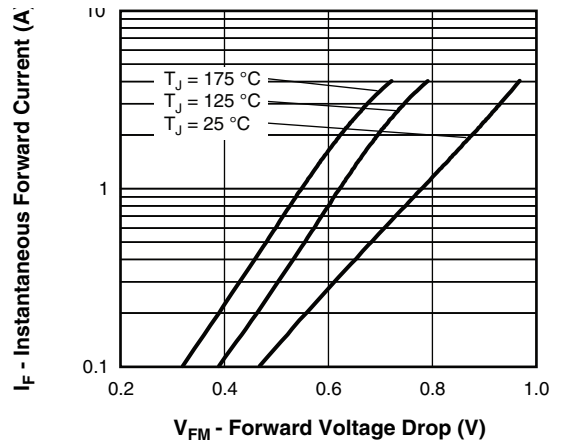

Fig. 2 - Maximum Forward Voltage Drop Characteristics

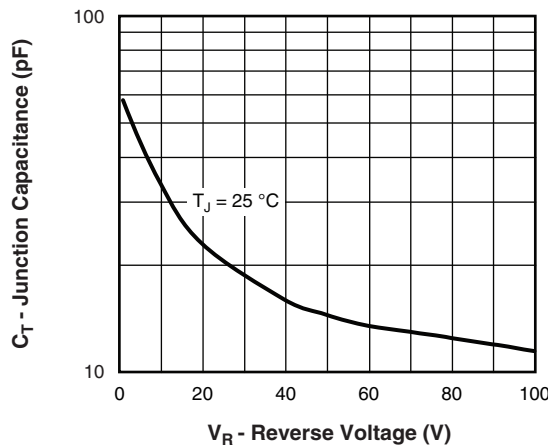

Fig. 3 - Typical Junction Capacitance vs. Reverse Voltage

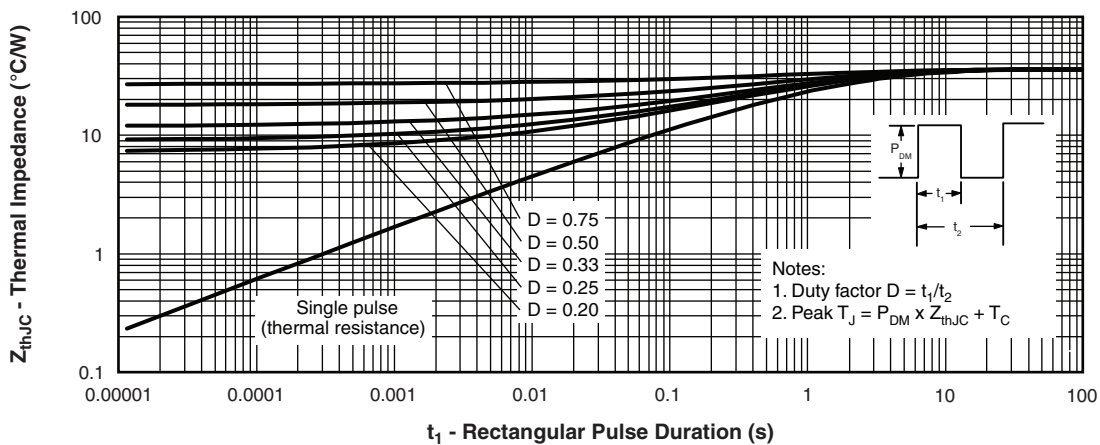

Fig. 4 - Maximum Thermal Impedance  $Z_{thJC}$  Characteristics (Per Leg)

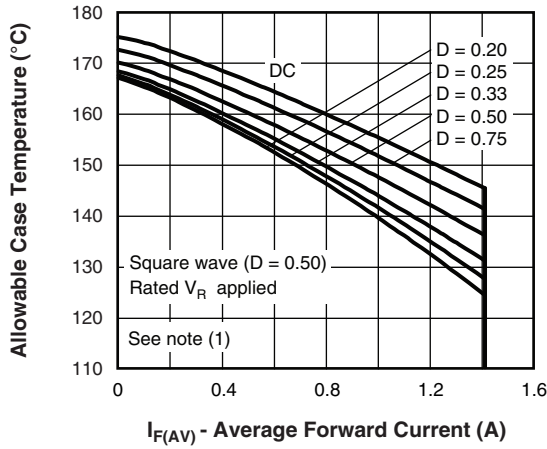

Fig. 5 - Maximum Average Forward Current vs. Allowable Lead Temperature

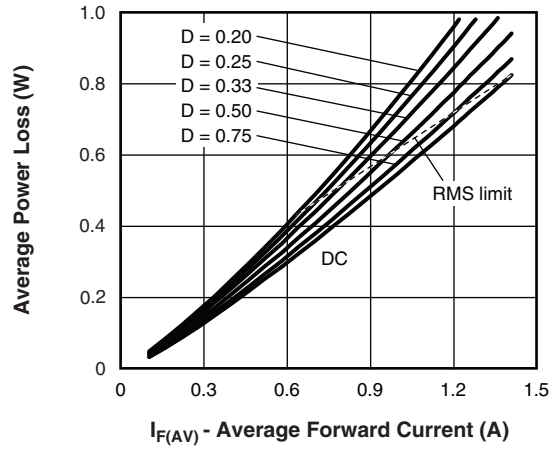

Fig. 6 - Maximum Average Forward Dissipation vs. Average Forward Current

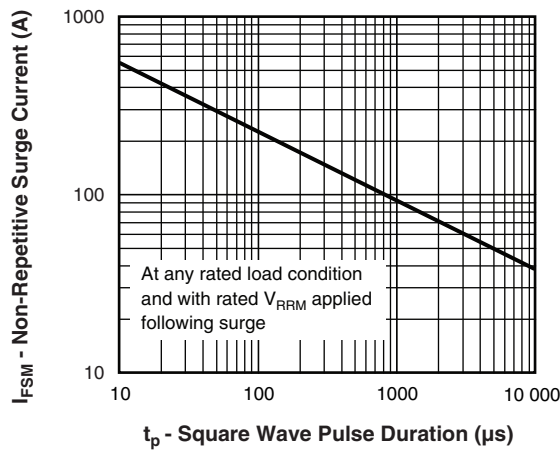

Fig. 7 - Maximum Peak Surge Forward Current vs. Pulse Duration

**Note**

- (1) Formula used:  $T_C = T_J - (Pd + Pd_{REV}) \times R_{thJC}$ ;  
 $Pd$  = forward power loss =  $I_{F(AV)} \times V_{FM}$  at  $(I_{F(AV)}/D)$  (see fig. 6);  
 $Pd_{REV}$  = inverse power loss =  $V_{R1} \times I_R (1 - D)$ ;  $I_R$  at  $V_{R1} = 80\%$  rated  $V_R$



## ORDERING INFORMATION TABLE

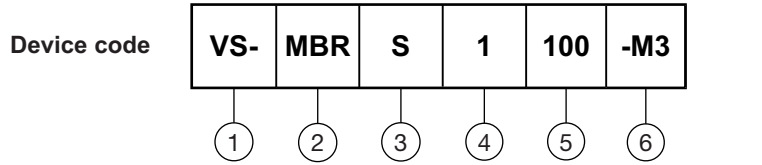

- 1** - Vishay Semiconductors product
- 2** - Schottky MBR series
- 3** - S = SMB (DO-214AA)
- 4** - Current rating (1 = 1 A)
- 5** - Voltage rating
 

90 = 90 V
100 = 100 V
- 6** - -M3 = halogen-free, RoHS-compliant, and termination lead (Pb)-free

<b>ORDERING INFORMATION</b> (Example)			
PREFERRED P/N	PREFERRED PACKAGE CODE	MINIMUM ORDER QUANTITY	PACKAGING DESCRIPTION
VS-MBRS190-M3/5BT	5BT	3200	13" diameter plastic tape and reel
VS-MBRS1100-M3/5BT	5BT	3200	13" diameter plastic tape and reel

<b>LINKS TO RELATED DOCUMENTS</b>	
Dimensions	<a href="http://www.vishay.com/doc?95401">www.vishay.com/doc?95401</a>
Part marking information	<a href="http://www.vishay.com/doc?95403">www.vishay.com/doc?95403</a>
Packaging information	<a href="http://www.vishay.com/doc?95404">www.vishay.com/doc?95404</a>
SPICE model	<a href="http://www.vishay.com/doc?95516">www.vishay.com/doc?95516</a>
SPICE model	<a href="http://www.vishay.com/doc?96602">www.vishay.com/doc?96602</a>

## SMB

**DIMENSIONS** in inches (millimeters)

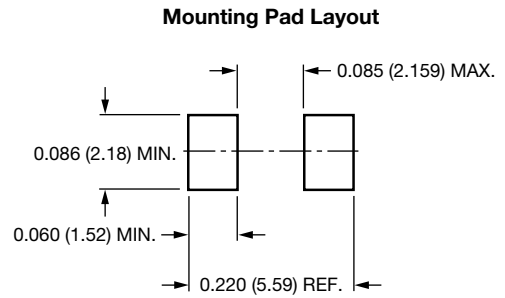
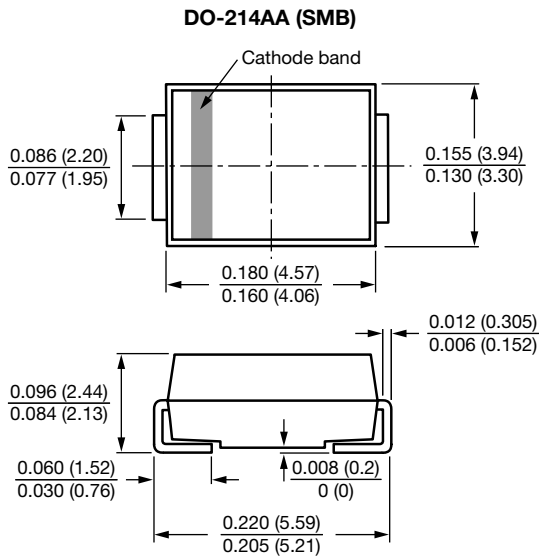



## **Disclaimer**

ALL PRODUCT, PRODUCT SPECIFICATIONS AND DATA ARE SUBJECT TO CHANGE WITHOUT NOTICE TO IMPROVE RELIABILITY, FUNCTION OR DESIGN OR OTHERWISE.

Vishay Intertechnology, Inc., its affiliates, agents, and employees, and all persons acting on its or their behalf (collectively, "Vishay"), disclaim any and all liability for any errors, inaccuracies or incompleteness contained in any datasheet or in any other disclosure relating to any product.

Vishay makes no warranty, representation or guarantee regarding the suitability of the products for any particular purpose or the continuing production of any product. To the maximum extent permitted by applicable law, Vishay disclaims (i) any and all liability arising out of the application or use of any product, (ii) any and all liability, including without limitation special, consequential or incidental damages, and (iii) any and all implied warranties, including warranties of fitness for particular purpose, non-infringement and merchantability.

Statements regarding the suitability of products for certain types of applications are based on Vishay's knowledge of typical requirements that are often placed on Vishay products in generic applications. Such statements are not binding statements about the suitability of products for a particular application. It is the customer's responsibility to validate that a particular product with the properties described in the product specification is suitable for use in a particular application. Parameters provided in datasheets and / or specifications may vary in different applications and performance may vary over time. All operating parameters, including typical parameters, must be validated for each customer application by the customer's technical experts. Product specifications do not expand or otherwise modify Vishay's terms and conditions of purchase, including but not limited to the warranty expressed therein.

Except as expressly indicated in writing, Vishay products are not designed for use in medical, life-saving, or life-sustaining applications or for any other application in which the failure of the Vishay product could result in personal injury or death. Customers using or selling Vishay products not expressly indicated for use in such applications do so at their own risk. Please contact authorized Vishay personnel to obtain written terms and conditions regarding products designed for such applications.

No license, express or implied, by estoppel or otherwise, to any intellectual property rights is granted by this document or by any conduct of Vishay. Product names and markings noted herein may be trademarks of their respective owners.

## X-ON Electronics

Largest Supplier of Electrical and Electronic Components

*Click to view similar products for [Schottky Diodes & Rectifiers](#) category:*

*Click to view products by [Vishay](#) manufacturer:*

Other Similar products are found below :

[MA4E2039](#) [D1FH3-5063](#) [MBR10100CT-BP](#) [MBR1545CT](#) [MMBD301M3T5G](#) [RB160M-50TR](#) [RB551V-30](#) [BAS16E6433HTMA1](#) [BAT](#)  
[54-02LRH E6327](#) [NSR05F40QNXT5G](#) [NTE555](#) [JANS1N6640](#) [SB07-03C-TB-H](#) [SB1003M3-TL-W](#) [SK310-T](#) [SK32A-LTP](#) [SK33A-TP](#)  
[SK34B-TP](#) [SS3003CH-TL-E](#) [GA01SHT18](#) [CRS10I30A\(TE85L,QM](#) [MA4E2501L-1290](#) [MBRB30H30CT-1G](#) [SB007-03C-TB-E](#) [SK32A-TP](#)  
[SK33B-TP](#) [SK35A-TP](#) [SK38B-TP](#) [NRVBM120LT1G](#) [NTE505](#) [NTSB30U100CT-1G](#) [SS15E-TP](#) [VS-6CWQ10FNHM3](#) [ACDBA1100LR-HF](#)  
[ACDBA1200-HF](#) [ACDBA140-HF](#) [ACDBA2100-HF](#) [ACDBA3100-HF](#) [CDBQC0530L-HF](#) [CDBQC0240LR-HF](#) [ACDBA340-HF](#)  
[ACDBA260LR-HF](#) [ACDBA1100-HF](#) [SK310B-TP](#) [MA4E2502L-1246](#) [MA4E2502H-1246](#) [NRVBM120ET1G](#) [NSR01L30MXT5G](#) [NTE573](#)  
[NTE6081](#)