

Ultra High Precision Z-Foil Surface Mount Current Sensing Chip Resistor with TCR of ± 0.05 ppm/ $^{\circ}\text{C}$ and Power Coefficient of 5 ppm at Rated Power

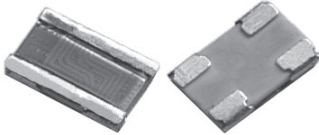

INTRODUCTION

The Z-foil technology provides a significant reduction of the resistive component's sensitivity to ambient temperature variations (TCR) and applied power changes (PCR). Designers can now guarantee a high degree of stability and accuracy in fixed-resistor applications using solutions based on Vishay's revolutionary Z-foil technology.

Model VCS1625Z is a surface mount chip resistor designed with 4 pads for Kelvin connection. Utilizing Vishay's Bulk Metal[®] Z-foil as the resistance element, it provides performance capabilities far greater than other resistor technologies can supply in a product of comparable size. 0.05 ppm/ $^{\circ}\text{C}$ absolute TCR removes errors due to temperature gradients.

This small device dissipates heat almost entirely through the pads so surface mount users are encouraged to be generous with the board's pads and traces.

Our application engineering department is available to advise and to make recommendations. For non-standard technical requirements and special applications, please contact us.

FIGURE 1 - POWER DERATING CURVE

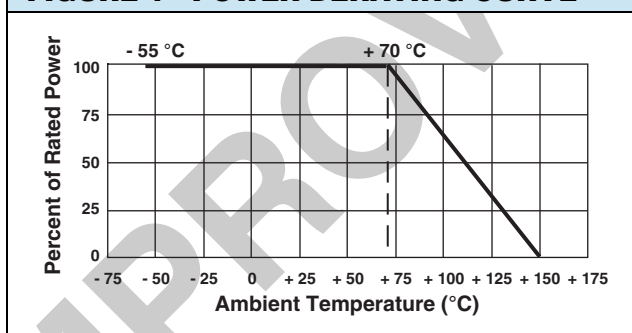

FEATURES

- Temperature coefficient of resistance (TCR):
 - ± 0.05 ppm/ $^{\circ}\text{C}$ typical (0 $^{\circ}\text{C}$ to + 60 $^{\circ}\text{C}$)
 - ± 0.2 ppm/ $^{\circ}\text{C}$ typical (- 55 $^{\circ}\text{C}$ to + 125 $^{\circ}\text{C}$, + 25 $^{\circ}\text{C}$ ref.) (see table 1)
- Resistance range: 0.3 Ω to 10 Ω (for higher or lower values please contact us)
- Foil resistors are not restricted to standard values, we can supply specific "as required" values at no extra cost or delivery (e.g. 1.234 Ω vs. 1 Ω)
- Tolerance: to ± 0.2 %
- Power coefficient " ΔR due to self heating": 5 ppm at rated power
- Load life stability: 0.02 % at 70 $^{\circ}\text{C}$, 2000 h at rated power
- Electrostatic discharge (ESD) up to 25 000 V
- Short time overload < 0.005 %
- Power rating: 0.5 W at + 70 $^{\circ}\text{C}$ (figure 1)
- Non inductive, non capacitive design
- Rise time: 1 ns effectively no ringing
- Current rating: 5 A maximum
- Current noise: < - 40 dB
- Voltage coefficient: < 0.1 ppm/V
- Non inductive: < 0.08 μH
- Non hot spot design
- Prototype samples available from 72 h. For more information, please contact foil@vishaypg.com
- For better performances please contact us



RoHS*
COMPLIANT

TERMINATIONS

- Two lead (Pb)-free options are available:
 - gold plated or tin plated
 - Tin/lead plated

APPLICATIONS

- Military
- Medical
- Automatic test equipment (ATE)
- Airborne (in heads-up display systems)
- High precision instrumentation
- Electron beam recording equipment
- Electron microscopes
- Current sensing applications
- Forced balance electronic scales
- Applications that require superior frequency stability

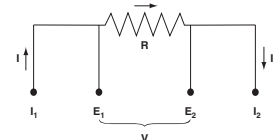

TABLE 1 - SPECIFICATIONS (2)

MODEL NUMBER	RESISTANCE RANGE	RESISTANCE TOLERANCE	TYPICAL TCR and MAX. SPREAD (- 55 $^{\circ}\text{C}$ to + 125 $^{\circ}\text{C}$, + 25 $^{\circ}\text{C}$)	POWER RATING at + 70 $^{\circ}\text{C}$ (1)	MAXIMUM CURRENT (1)
VCS1625Z	> 2.0 Ω to 10 Ω 0.3 Ω to 2.0 Ω	± 0.2 %, ± 0.5 %; ± 1.0 % ± 0.5 %; ± 1.0 %	$\pm 0.2 \pm 2.8$ ppm/ $^{\circ}\text{C}$	0.5 W on FR4 PCB	5 A

Notes

(1) Whichever is lower

(2) Tighter performances are available. Please contact application engineering foil@vishaypg.com

* Pb containing materials are not RoHS compliant, exemptions may apply

FIGURE 2 - DIMENSIONS in inches (millimeters)

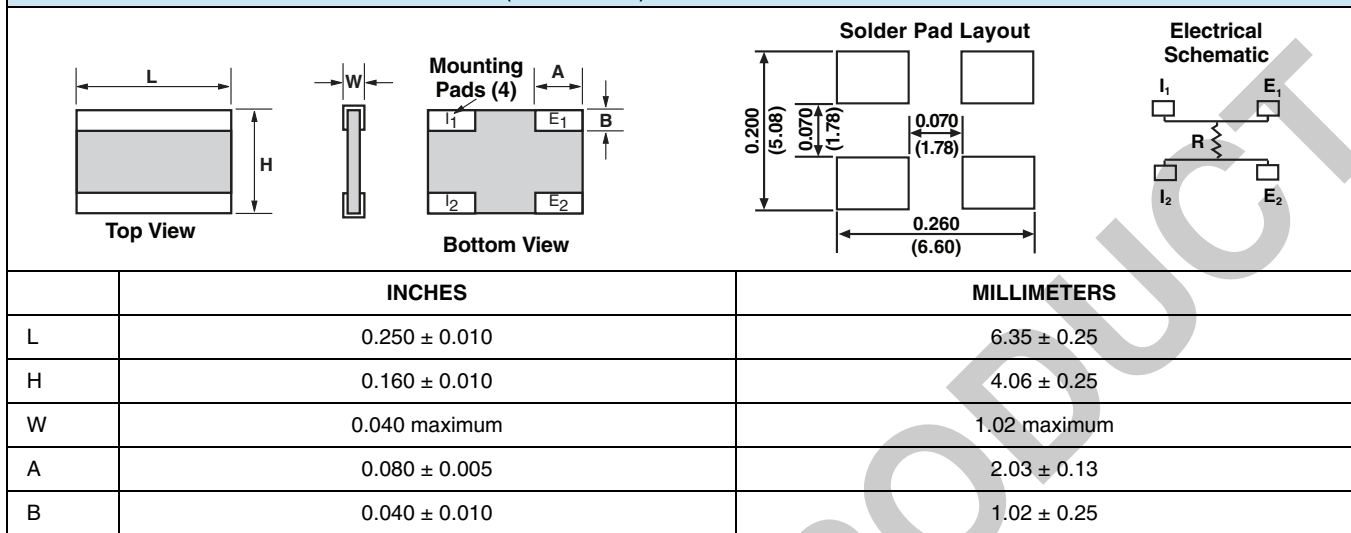

FIGURE 3 - TRIMMING TO VALUES
(Conceptual Illustration)

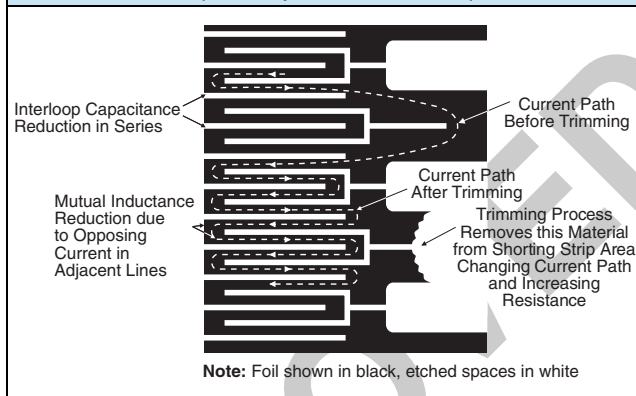

FIGURE 4 - TYPICAL TCR CURVE Z-FOIL

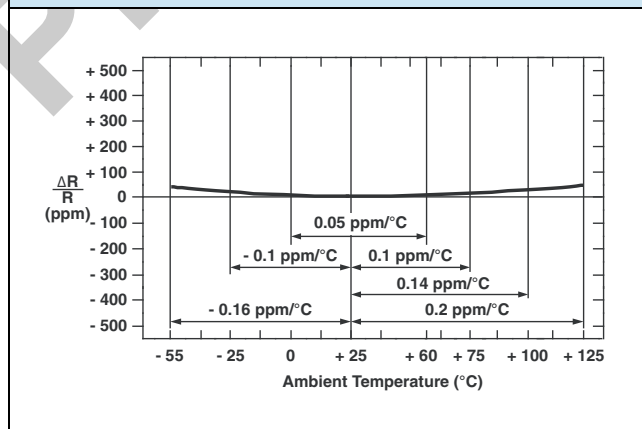

TABLE 2 - PERFORMANCE SPECIFICATIONS

TEST	MIL-PRF-55342 ΔR LIMITS	TYPICAL ΔR LIMITS	MAXIMUM ΔR LIMITS (1)
Thermal shock 5 x (- 65 °C to + 150 °C)	± 0.10 %	± 0.005 % (50 ppm)	± 0.01 % (100 ppm)
Low temperature operation	± 0.10 %	± 0.005 % (50 ppm)	± 0.01 % (100 ppm)
Short time overload	± 0.10 %	± 0.005 % (50 ppm)	± 0.02 % (200 ppm)
High temperature exposure	± 0.10 %	± 0.01 % (100 ppm)	± 0.02 % (200 ppm)
Resistance to soldering heat	± 0.2 %	± 0.01 % (100 ppm)	± 0.03 % (300 ppm)
Moisture resistance	± 0.2 %	± 0.01 % (100 ppm)	± 0.03 % (300 ppm)
Load life 2000 h at 70 °C: rated power on ceramic PCB	± 0.5 %	± 0.02 % (200 ppm)	± 0.04 % (400 ppm)

Note

(1) Measurement error 0.001R

TABLE 3 - GLOBAL PART NUMBER INFORMATION

NEW GLOBAL PART NUMBER: Y16071R5000D9W (preferred part number format)

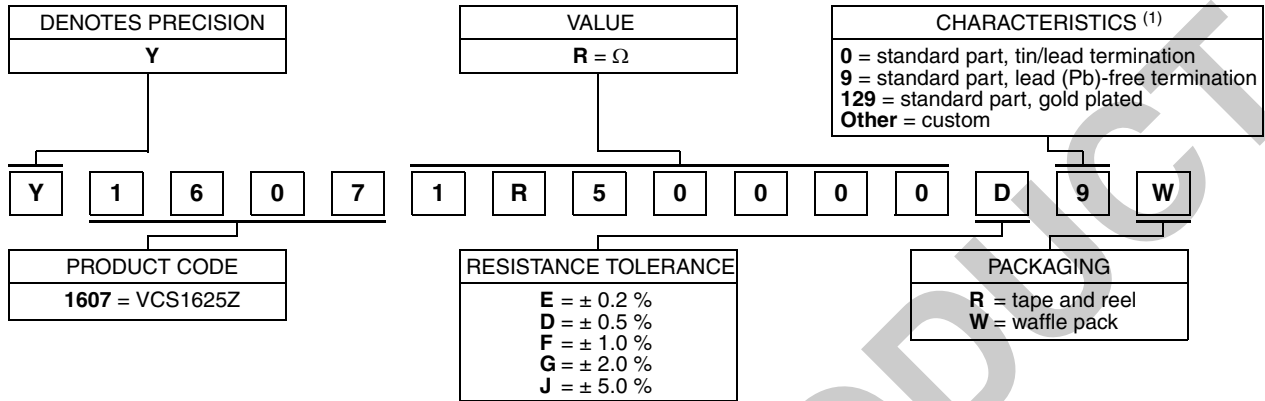

FOR EXAMPLE: ABOVE GLOBAL ORDER Y1607 1R5000 D 9 W:

TYPE: VCS1625Z

VALUE: 1.5 Ω

ABSOLUTE TOLERANCE: ± 0.5 %

TERMINATION: lead (Pb)-free

PACKAGING: waffle pack

HISTORICAL PART NUMBER: VCS1625Z 1R5000 TCR0.2 D S W (will continue to be used)

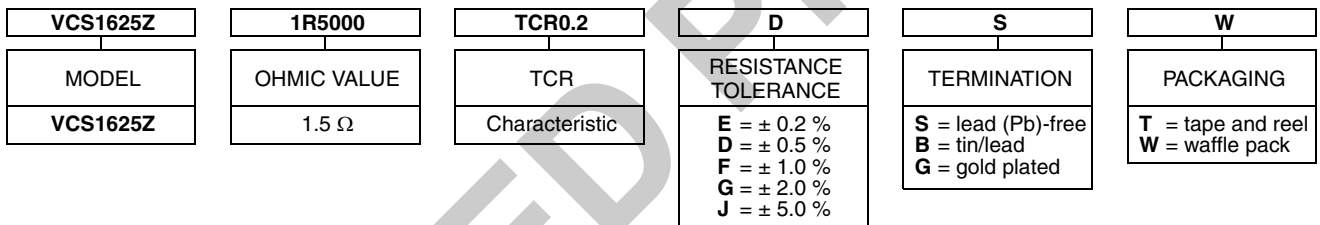

Note

⁽¹⁾ Application engineering release: for non-standard requests, please contact application engineering.



Disclaimer

ALL PRODUCTS, PRODUCT SPECIFICATIONS AND DATA ARE SUBJECT TO CHANGE WITHOUT NOTICE.

Vishay Precision Group, Inc., its affiliates, agents, and employees, and all persons acting on its or their behalf (collectively, "VPG"), disclaim any and all liability for any errors, inaccuracies or incompleteness contained herein or in any other disclosure relating to any product.

The product specifications do not expand or otherwise modify VPG's terms and conditions of purchase, including but not limited to, the warranty expressed therein.

VPG makes no warranty, representation or guarantee other than as set forth in the terms and conditions of purchase. **To the maximum extent permitted by applicable law, VPG disclaims (i) any and all liability arising out of the application or use of any product, (ii) any and all liability, including without limitation special, consequential or incidental damages, and (iii) any and all implied warranties, including warranties of fitness for particular purpose, non-infringement and merchantability.**

Information provided in datasheets and/or specifications may vary from actual results in different applications and performance may vary over time. Statements regarding the suitability of products for certain types of applications are based on VPG's knowledge of typical requirements that are often placed on VPG products. It is the customer's responsibility to validate that a particular product with the properties described in the product specification is suitable for use in a particular application. You should ensure you have the current version of the relevant information by contacting VPG prior to performing installation or use of the product, such as on our website at vpgsensors.com.

No license, express, implied, or otherwise, to any intellectual property rights is granted by this document, or by any conduct of VPG.

The products shown herein are not designed for use in life-saving or life-sustaining applications unless otherwise expressly indicated. Customers using or selling VPG products not expressly indicated for use in such applications do so entirely at their own risk and agree to fully indemnify VPG for any damages arising or resulting from such use or sale. Please contact authorized VPG personnel to obtain written terms and conditions regarding products designed for such applications.

Product names and markings noted herein may be trademarks of their respective owners.

Copyright Vishay Precision Group, Inc., 2014. All rights reserved.

X-ON Electronics

Largest Supplier of Electrical and Electronic Components

Click to view similar products for [Current Sense Resistors - SMD category](#):

Click to view products by [Vishay manufacturer](#):

Other Similar products are found below :

[CRL0603-FW-R700ELF](#) [65709-330JE](#) [PF2512FKF7W0R007L](#) [PR2512FKF7W0R003L](#) [PR2512FKF7W0R005L](#) [PF2512FKF7W0R006L](#)
[PF2512FKF7W0R033L](#) [CD2015FC-0.10-1%](#) [PR2512FKF7W0R004L](#) [RC1005F124CS](#) [RL73K3AR56JTDF](#) [RL7520WT-R001-F](#)
[RL7520WT-R009-G](#) [RL7520WT-R020-F](#) [RLP73N1ER43JTD](#) [LRC-LR2512LF-01-R820J](#) [WR06X104JGLJ](#) [TL2BR01F](#) [65709-330](#) [SP1R12J](#)
[RL7520WT-R039-G](#) [PF1206FRF7W0R02L](#) [RL7520WT-R002-F](#) [RL7520WT-R047-F](#) [KRL1632E-C-R200-F-T5](#) [KRL1632E-C-R200-F-T1](#)
[Y14880R02000B9R](#) [RLP73M1ER051FTDF](#) [RLP73M2AR051FTDF](#) [RLP73M2AR075FTDF](#) [RLP73K2A1R0FTDF](#) [RLP73M1JR051FTDF](#)
[RLP73N1JR47FTDF](#) [SR731ERTTP5R10F](#) [SR731ERTTP100J](#) [SR731ERTTP6R80F](#) [SR731ERTTP4R70F](#) [SR731ERTTP2R20F](#)
[SR731ERTTP3R90F](#) [SR731ERTTP1R00F](#) [SR731ERTTP10R0F](#) [SR731ERTTP2R00F](#) [SR731ERTTP8R20F](#) [SR731ERTTP3R9J](#)
[SR731ERTTP8R2J](#) [SR731ERTTP2R0J](#) [SR731ERTTP4R7J](#) [SR731ERTTP9R1J](#) [SR731ERTTP1R0J](#) [SR731ERTTP2R2J](#)