

SMD Aluminum Electrolytic Capacitors



FEATURES

- Polarized aluminum electrolytic capacitors, non-solid electrolyte
- SMD version with base plate, vertical construction, requiring minimum board space
- High CV per unit volume, low impedance, high ripple current
- Ø 4 mm to Ø 18 mm, 105 °C, 2000 h to 5000 h load life
- Material categorization: for definitions of compliance please see www.vishay.com/doc?99912

RoHS
COMPLIANT

APPLICATIONS

- SMD technology, in compliance with RoHS
- Coupling, decoupling, smoothing, filtering, buffering, timing
- General industrial, portable, and lightweight equipment

QUICK REFERENCE DATA

DESCRIPTION	UNIT	VALUE
Nominal case sizes (Ø D x L)	mm	4 x 5.7 to 18 x 21.5
Rated capacitance range	µF	1 to 8200
Capacitance tolerance	%	± 20 (at 120 Hz, 20 °C)
Rated voltage range	V _{DC}	6.3 to 100
Category temperature range	°C	-55 to +105
Endurance	h	2000 to 5000
Shelf life	h	1000

ORDERING INFORMATION

Part number example: ZSC00FE2211HARL

ZSC	00	FE	221	1H	AR	L
SERIES NAME	DESIGN / FORMING	DIMENSIONS	CAPACITANCE	VOLTAGE	PACKING	INTERNAL CODE
		See "Dimensions" table	See "Selection Chart"	See "Selection Chart"	Tape and Reel	

**ADDITIONAL ELECTRICAL DATA**

LEAKAGE CURRENT (Test conditions: U_R , 20 °C)			
RATED VOLTAGE	TIME	CASE SIZE	VALUE
6.3 V to 100 V	after 2 min	Ø 4 mm to Ø 18 mm	$I = 0.01 CV$ or 3 μA , whichever is greater

Notes

- Where, C = rated capacitance in μF
- V = rated DC working voltage in V

DISSIPATION FACTOR ($\tan \delta$ at 120 Hz, 20 °C)									
RATED VOLTAGE	6.3	10	16	25	35	50	63	80	100
$\tan \delta$ (max.)	0.30	0.26	0.22	0.16	0.13	0.10	0.08	0.08	0.07

Note

- When the capacitance exceeds 1000 μF , 0.002 shall be added every 1000 μF increase.

LOW TEMPERATURE BEHAVIOR (at 120 Hz)									
IMPEDANCE RATIO	RATED VOLTAGE								
	6.3	10	16	25	35	50	63	80	100
$\frac{Z_{(-25\text{ °C})}}{Z_{(+20\text{ °C})}}$	4	3	2	2	2	2	2	2	2
$\frac{Z_{(-55\text{ °C})}}{Z_{(+20\text{ °C})}}$	8	5	4	3	3	3	3	3	3

MULTIPLIER OF RIPPLE CURRENT AS A FUNCTION OF FREQUENCY	
FREQUENCY (Hz)	CAPACITANCE (μF)
50, 60	0.60
120	0.70
1000	0.85
10 000 and up	1.0

TEST PROCEDURES AND REQUIREMENTS				
TEST	TEST TIME	CAPACITANCE CHANGE	DISSIPATION FACTOR	LEAKAGE CURRENT
Endurance ⁽¹⁾	2000 h	Within $\pm 30\%$ of initial value for $\varnothing \leq D 6.3$ mm and $\varnothing 10 \times 7.7$ L	Less than 300 % of specified value	Within specified value
	5000 h	Within $\pm 30\%$ of initial value for $\varnothing \geq D 8$ mm		
Shelf life ⁽²⁾	1000 h	Within $\pm 30\%$ of initial value	Less than 300 % of specified value	

Notes

- ⁽¹⁾ The specifications shall be satisfied when the capacitors are restored to 20 °C after the rated voltage applied for 2000 h to 5000 h at 105 °C.
- ⁽²⁾ The above specifications shall be satisfied when the capacitors are restored to 20 °C after exposing them for 1000 h at 105 °C without voltage applied.

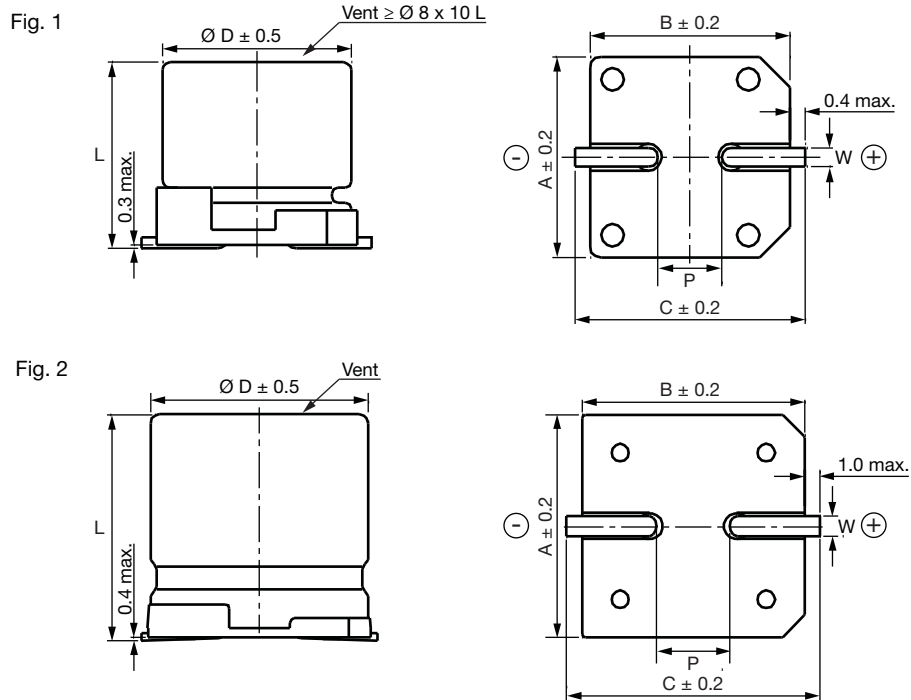
DIMENSIONS in millimeters

CASE SIZE CODE	Ø D	L	A	B	C	W	P ± 0.2	FIG. NO.
AB	4 x 5.7	4	5.7 ± 0.3	4.3	4.3	5.1	1.0	1
AC	5 x 5.7	5	5.7 ± 0.3	5.3	5.3	5.9	1.5	1
AD	6.3 x 5.7	6.3	5.7 ± 0.3	6.6	6.6	7.2	2.0	1
BM	6.3 x 7.7	6.3	7.7 ± 0.3	6.6	6.6	7.2	2.0	1
AE	8 x 6.5	8	6.5 ± 0.3	8.4	8.4	9.0	2.3	1
AF	8 x 10	8	10 ± 0.5	8.4	8.4	9.0	3.1	1
XM	10 x 7.7	10	7.7 ± 0.3	10.4	10.4	11.0	4.7	1
AG	10 x 10	10	10 ± 0.5	10.4	10.4	11.0	4.7	1
AH	12.5 x 13.5	12.5	13.5 ± 0.5	13.0	13.0	13.7	4.4	2
CX	12.5 x 16	12.5	16 ± 0.5	13.0	13.0	13.7	4.4	2
AK	16 x 16.5	16	16.5 ± 0.5	17.0	17.0	18.0	6.4	2
AM	16 x 21.5	16	21.5 ± 0.5	17.0	17.0	18.0	6.4	2
AN	18 x 16.5	18	16.5 ± 0.5	19.0	19.0	20.0	6.4	2
AP	18 x 21.5	18	21.5 ± 0.5	19.0	19.0	20.0	6.4	2

MARKING

Ø D ≤ 6.3 mm

Ø D = 8 mm to 10 mm

Ø D ≥ 12.5 mm

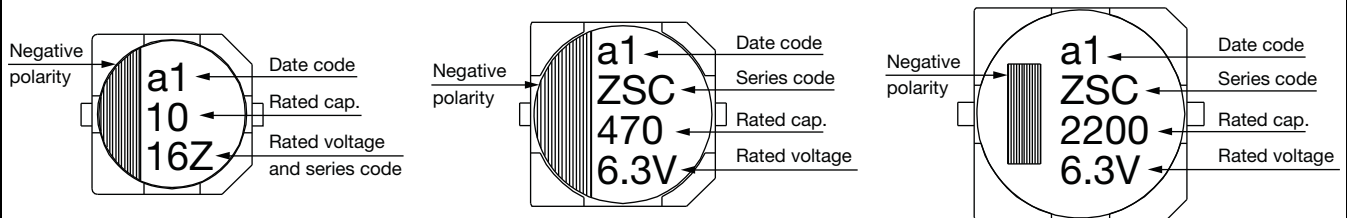



SELECTION CHART, DIMENSIONS, AND PERMISSIBLE RIPPLE CURRENT (at 100 kHz / 105 °C)																			
V _{DC}		6.3 (0J)			10 (1A)			16 (1C)			25 (1E)			35 (1V)			50 (1H)		
CAP.	CODE	Ø D x L	IMP.	mA	Ø D x L	IMP.	mA	Ø D x L	IMP.	mA	Ø D x L	IMP.	mA	Ø D x L	IMP.	mA	Ø D x L	IMP.	mA
1.0	010																4 x 5.7	2.9	60
2.2	2R2																4 x 5.7	2.9	60
3.3	3R3																4 x 5.7	2.9	60
4.7	4R7													4 x 5.7	1.35	80	5 x 5.7	1.52	85
10	100							4 x 5.7	1.35	80	4 x 5.7	1.35	80	5 x 5.7	0.80	150	6.3 x 5.7	0.88	165
22	220	4 x 5.7	1.35	80	4 x 5.7	1.35	80	5 x 5.7	0.80	150	5 x 5.7	0.80	150	6.3 x 5.7	0.44	230	6.3 x 5.7	0.88	165
33	330	4 x 5.7	1.35	80	5 x 5.7	0.80	150	6.3 x 5.7	0.44	230	6.3 x 5.7	0.44	230	6.3 x 5.7	0.44	230	6.3 x 7.7	0.68	185
47	470	5 x 5.7	0.80	150	6.3 x 5.7	0.44	230	6.3 x 5.7	0.44	230	6.3 x 5.7	0.44	230	6.3 x 5.7	0.44	230	6.3 x 7.7 8 x 6.5	0.68	185
68	680													8 x 6.5	0.36	280	8 x 10	0.34	369
100	101	6.3 x 5.7	0.44	230	6.3 x 5.7	0.44	230	6.3 x 5.7	0.44	230	6.3 x 7.7 8 x 6.5	0.36	280	8 x 10	0.17	450	8 x 10 10 x 10	0.34 0.18	369 553
150	151	6.3 x 5.7	0.44	230	6.3 x 5.7	0.44	230	6.3 x 7.7 8 x 6.5	0.36	280	8 x 10	0.17	450	8 x 10 10 x 7.7	0.17	450	10 x 10	0.18	553
220	221	6.3 x 7.7	0.36	280	6.3 x 7.7 8 x 6.5	0.36	280	6.3 x 7.7	0.36	280	8 x 10 10 x 7.7	0.17	450	10 x 10	0.09	670	12.5 x 13.5	0.12	650
330	331	8 x 6.5 8 x 10	0.36 0.17	280 450	8 x 10 10 x 7.7	0.17	450	8 x 10 10 x 7.7	0.17	450	8 x 10	0.17	450	12.5 x 13.5 10 x 10	0.070 0.09	820 670	12.5 x 13.5	0.12	650
470	471	8 x 10 10 x 7.7	0.17	450	8 x 10 10 x 7.7	0.17	450	8 x 10 10 x 10	0.17 0.09	450 670	10 x 10	0.09	670	12.5 x 16	0.060	950	16 x 16.5	0.073	1000
680	681	8 x 10 10 x 7.7	0.17	450	10 x 10	0.09	670	10 x 10	0.09	670	12.5 x 13.5	0.070	820	12.5 x 16	0.060	950	16 x 16.5	0.073	1000
1000	102	8 x 10	0.17	450	10 x 10	0.09	670	12.5 x 13.5	0.070	820	12.5 x 16	0.060	950	16 x 16.5	0.054	1260	18 x 16.5	0.066	1500
1500	152	10 x 10	0.09	670	12.5 x 13.5	0.070	820	12.5 x 16	0.060	950	16 x 16.5	0.054	1260	18 x 16.5 16 x 21.5	0.048 0.038	1500 1630	18 x 21.5	0.05	1620
2200	222	12.5 x 13.5	0.070	820	12.5 x 16	0.060	950	16 x 16.5	0.054	1260	16 x 16.5	0.054	1260	18 x 21.5	0.038	1750			
3300	332	12.5 x 16	0.060	950	16 x 16.5	0.054	1260	16 x 16.5 16 x 21.5	0.054 0.038	1260 1630	18 x 16.5 16 x 21.5 18 x 21.5	0.048 0.038 0.038	1500 1630 1750						
4700	472	16 x 16.5	0.054	1260	16 x 16.5	0.054	1260	18 x 16.5 16 x 21.5	0.048 0.038	1500 1630									
6800	682	18 x 16.5 16 x 21.5	0.048 0.038	1500 1630	18 x 16.5 16 x 21.5	0.048 0.038	1500 1630												
8200	822	18 x 16.5 16 x 21.5	0.048 0.038	1500 1630	18 x 21.5	0.038	1750												

SELECTION CHART, DIMENSIONS, AND PERMISSIBLE RIPPLE CURRENT (at 100 kHz / 105 °C)										
V _{DC}		63 (1J)			80 (1K)			100 (2A)		
CAP.	CODE	Ø D x L	IMP.	mA	Ø D x L	IMP.	mA	Ø D x L	IMP.	mA
4.7	4R7	5 x 5.7	1.90	70						
10	100	6.3 x 5.7	1.20	130						
22	220	6.3 x 7.7	0.90	150	8 x 10	1.3	130	8 x 10	1.3	130
33	330	8 x 10	0.50	280	8 x 10	1.3	130	10 x 10	0.7	200
47	470	8 x 10	0.50	280	10 x 10	0.7	200	10 x 10	0.7	200
100	101	10 x 10	0.25	450	10 x 10	0.7	200	12.5 x 13.5	0.32	450
150	151	12.5 x 13.5	0.15	700	12.5 x 13.5	0.32	450	12.5 x 16	0.26	550
220	221	12.5 x 13.5	0.15	700	12.5 x 16	0.26	550	16 x 16.5 18 x 21.5	0.17 0.15	650 950
330	331	16 x 16.5	0.082	900	16 x 16.5	0.17	650	18 x 16.5 16 x 21.5	0.15	850 900
470	471	16 x 16.5	0.082	900	16 x 21.5	0.15	900	18 x 21.5	0.15	950
680	681	18 x 16.5 16 x 21.5	0.080	1150	18 x 21.5	0.15	950			
1000	102	18 x 21.5	0.060	1250						

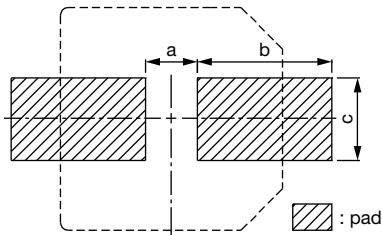
SOLDERING

Recommended soldering pad dimensions

RECOMMENDED SOLDERING PAD DIMENSIONS in millimeters			
CASE SIZE (\emptyset)	LAND SIZE		
	a	b	c
3	0.8	2.2	1.6
4	1.0	2.6	1.6
5	1.4	3.0	1.6
6.3	1.9	3.5	1.6
8 x 6.5	2.1	4.0	1.6
8	3.0	3.5	2.5
10	4.0	4.0	2.5
12.5	4.0	6.0	3.2
16	6.0	7.0	3.2
18	6.0	8.0	3.2

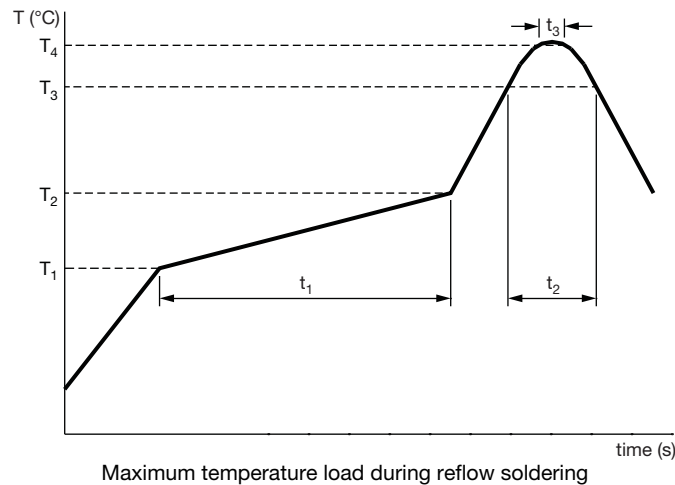
STANDARD SOLDERING PROFILE FOR LEAD (Pb)-FREE REFLOW PROCESS

REFLOW SOLDERING CONDITIONS					
Rated voltage (V)	4 to 50	4 to 50	63 and up	4 and up	
Case size (\emptyset)	4 to 6.3 x 4.5 l	3 to 6.3	3 to 6.3	8 to 18	
Preheat	Temperature (T_1 to T_2 , °C)	150 to 180			
	Time (t_1) (max., s)	1210	100		
Duration	Temperature (T_3 , °C)	230	217	230	217
	Time (t_2) (max., s)	30	90	60	40
Peak	Temperature (T_4 , °C)	250	260		250
	Time (t_3 , s)	5			
Reflow cycles	1			2 or less	

X-ON Electronics

Largest Supplier of Electrical and Electronic Components

Click to view similar products for [Aluminium Electrolytic Capacitors - SMD category](#):

Click to view products by [Vishay manufacturer](#):

Other Similar products are found below :

[EEV-FK1E332W](#) [22927](#) [MAL214099813E3](#) [HUB1800-S](#) [34610](#) [RYK-50V101MG5TT-FL](#) [107AXZ016MQ5](#) [EMK1EM471GB0D00R](#)
[EMK1VM101E83D00R](#) [RVT2A4R7M0605](#) [MAL214097402E3](#) [MAL224699909E3](#) [MAL224699813E3](#) [MAL215099017E3](#)
[MAL215099117E3](#) [MAL215099818E3](#) [AEH1010471M010R](#) [AEA1010681M016R](#) [AEA1010471M025R](#) [AEA0810331M010R](#)
[AEA1616102M050R](#) [AEH1010101M050R](#) [AEA1010102M010R](#) [AEH0810470M050R](#) [AEA0810220M100R](#) [AEA0810151M035R](#)
[AEA0810331M016R](#) [AEA0810470M063R](#) [AEA1213471M035R](#) [AEH0608101M016R](#) [AEH0608220M050R](#) [AEH0608330M050R](#)
[AEH0608470M025R](#) [AEH0608470M035R](#) [AEH0810101M025R](#) [AEH1012101M063R](#) [GSC00AC3301AARL](#) [GSC00AC3301CARL](#)
[ZSC00AF2211EARL](#) [VB1E100MB054000CE0](#) [HV100M100E077ETR](#) [RC0J226M04005VR](#) [RC0J476M05005VR](#) [RC1A227M08010VR](#)
[RC1C476M6L005VR](#) [RC1V227M10010VR](#) [35SZV10M5X5.5](#) [MAL214099111E3](#) [EXV107M025A9HAA](#) [50SKV1M4X5.5](#)