

DSM Series Ultra Thin Surface Mount Single Digit 7-Segment LED Display

DSM7UA20105 - 0.20" (5.08mm) Digit Height
Emitting Color: Pure Green (InGaN/GaN)

Applications

- People Movers
- Home Appliances
- Medical Devices
- Industrial Devices
- Automation and Controls
- Light Control
- IoT
- Transportation
- Food Service Appliances

Key Features

- 1-digit seven segment led numeric display
- Outer dimensions: 11.0 x 7.40 x 3.10mm
- Reduce overall thickness of PCB, with major cost savings
- Available in 4 different digit heights and widths
- Excellent character appearance, with high light output
- Pure green chip
- Made from InGaN on transparent GaN substrate
- Made of white segments and gray surface
- Also available in super bright red
- Available in cut tape or automation-friendly tape and reel
- Exclusive patented technology
- Low current operation and lower power consumption
- Polarity: common anode
- Available for reverse mounting configuration
- Side by side mounting allows space saving
- Easy mounting on PC boards or sockets
- Moisture Sensitive Level (MSL): 2a
- Life expectancy: 100,000 hours
- Technically and mechanically rugged
- Quality tested with the highest industry standard

Ordering Data

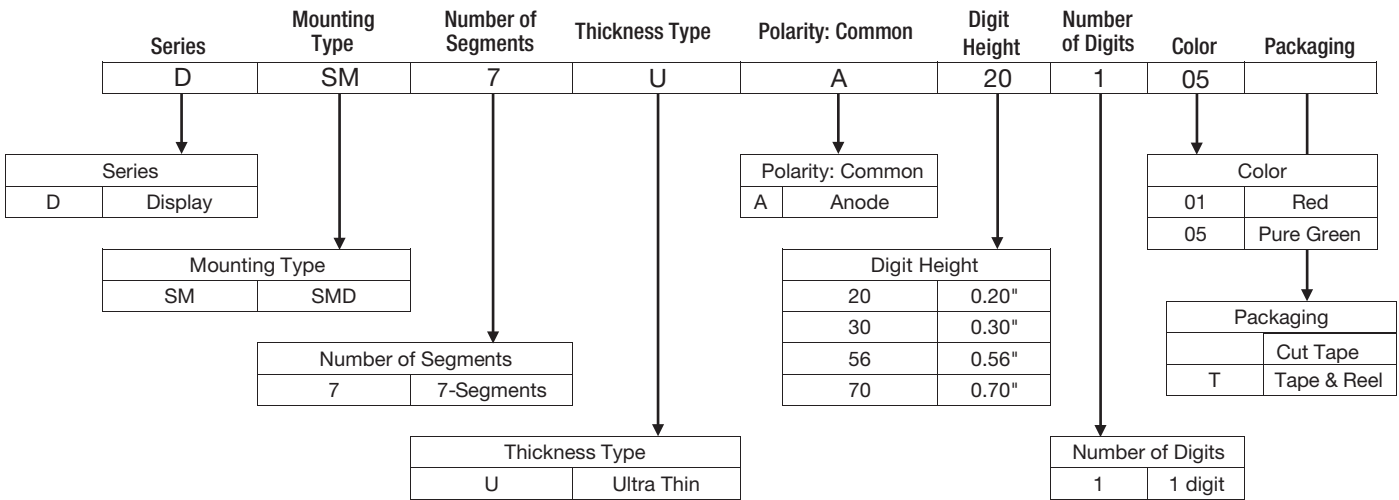

Dimensions and Internal Circuit Diagram

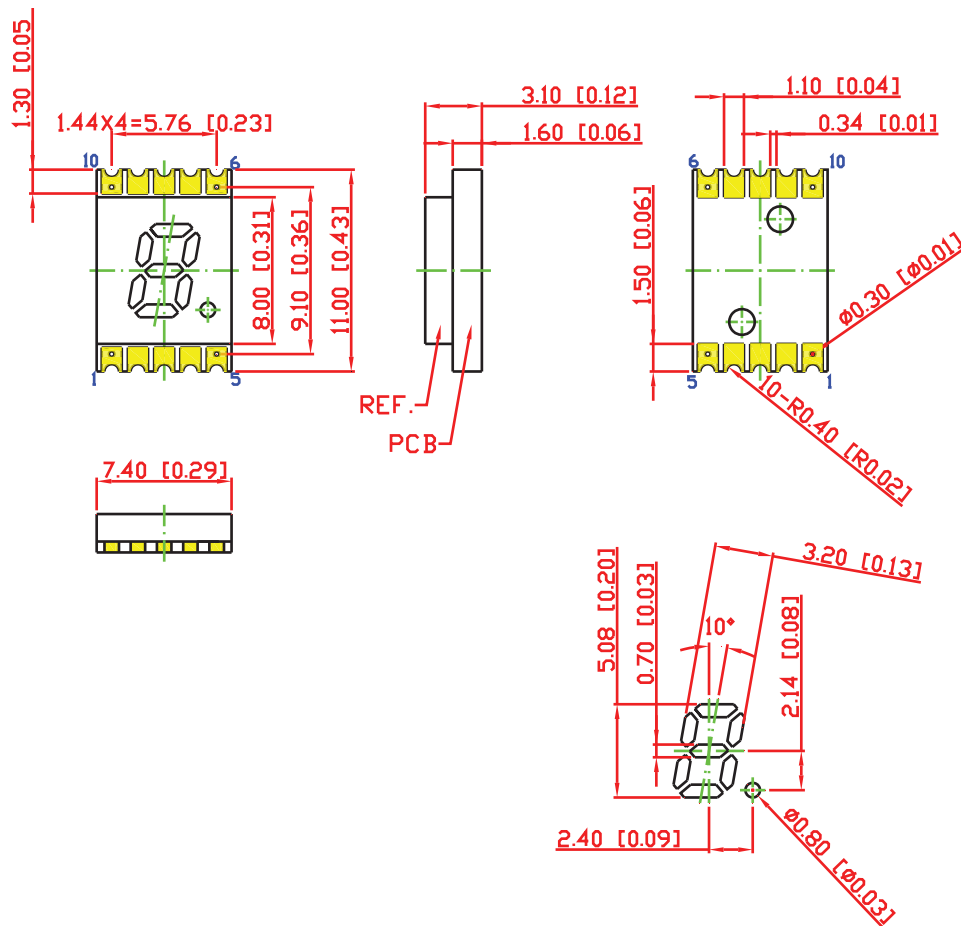

Dimensions in millimeters [inches]
Tolerance is $\pm 0.25\text{mm}$ [.01"] unless otherwise noted

Dimensions and Internal Circuit Diagram

Recommended Reverse Mount Solder Pattern

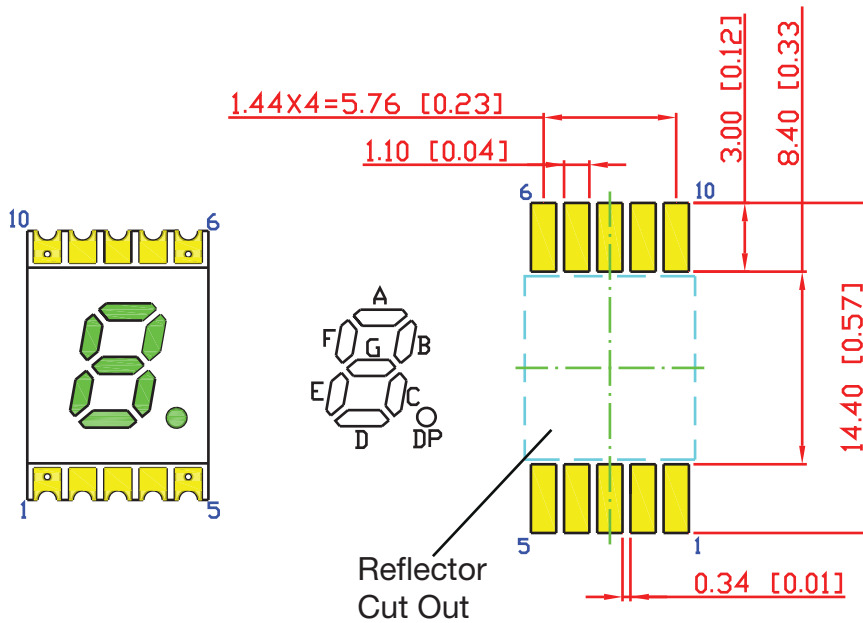

Dimensions in millimeters [inches]

Tolerance is $\pm 0.25\text{mm}$ [.01"] unless otherwise noted

Pin Connections (Common Anode)

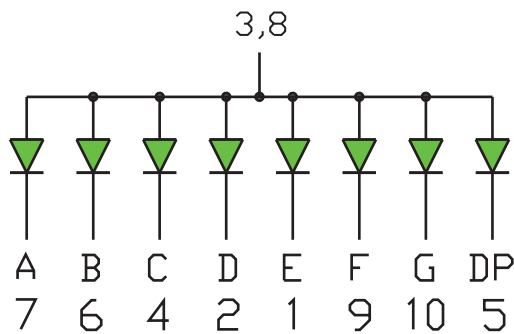

| PIN No | Connection |
|--------|--------------|
| 1 | CATHODE E |
| 2 | CATHODE D |
| 3 | COMMON ANODE |
| 4 | CATHODE C |
| 5 | CATHODE DP |
| 6 | CATHODE B |
| 7 | CATHODE A |
| 8 | COMMON ANODE |
| 9 | CATHODE F |
| 10 | CATHODE G |

Product Specifications

Absolute Maximum Rating at Ta=25°C / 77°F (Ta= Ambient Temperature)

| Parameter | Symbol | Maximum Rating | Unit |
|--------------------------------------|------------------|----------------------------|------------|
| Power dissipation | P _{AD} | 120 | mW |
| Derating liner from 25°C/77°F | - | 0.30/9.46 | mA °C / °F |
| Continuous forward current | I _{AF} | 30 | mA |
| Peak current (duty cycle 1/10, 1kHz) | I _{PF} | 100 | mA |
| Reverse voltage | V _R | 5 | V |
| Operating temperature | T _{OPR} | -40 TO +105 -40 TO +221 | °C °F |
| Storage temperature | T _{STG} | -40 TO +105 -40 TO +221 | °C °F |

Electrical - Optical Characteristics at Ta=25°C / 77°F (Ta= Ambient Temperature)

| Charateristic | Symbol | Condition | Min. | Typ. | Max. | Unit |
|------------------------------|----------------|----------------------|------|------|------|------|
| Forward Voltage, (Per Dice) | V _F | I _F =20mA | - | 2.8 | 3.6 | V |
| Reverse Current, (Per Dice) | I _R | V _R =8V | - | - | 10 | μA |
| Dominant Wavelength | λ _D | I _F =20mA | 515 | - | 530 | nm |
| Luminous Intensity | I _V | I _F =20mA | 40 | - | 100 | mcd |
| Spectral radiation bandwidth | Δλ | I _F =20mA | - | 30 | - | nm |

Product Specifications

Typical Electro-optical Characteristic Curves (25°C / 77°F Free Air Temperature Unless Otherwise Specified)

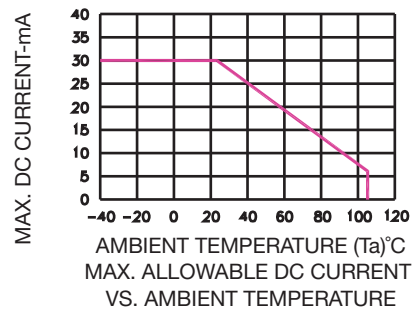
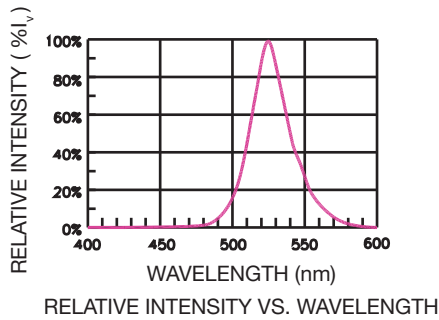
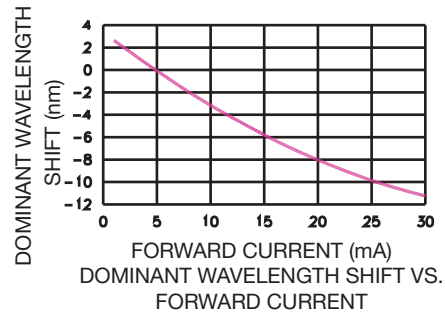
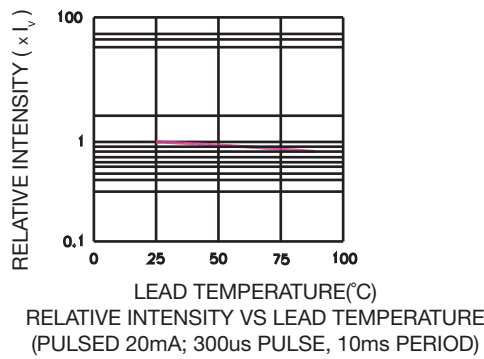
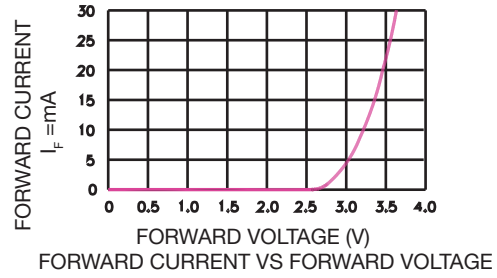
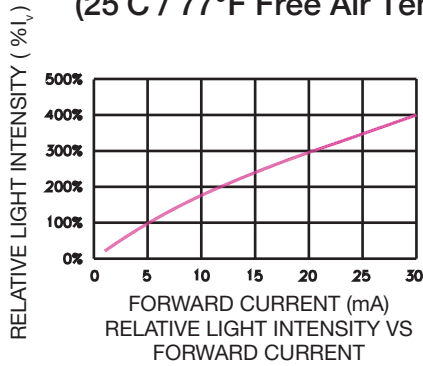

Circuit Design Notes

- Always use current limit resistors when necessary
- LEDs could be electrically connected in parallel, with each LED having its own current limiting resistor

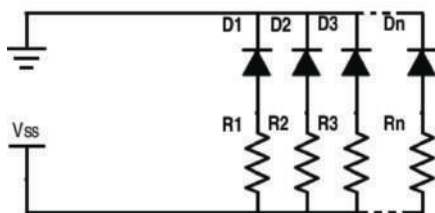

Correct

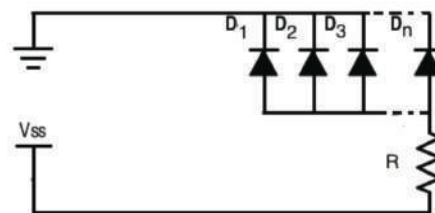

Incorrect

Recommended Reflow Soldering Profile

- SMT Reflow Soldering Instructions

SMT Soldering Profile
Pb free reflow soldering Profile

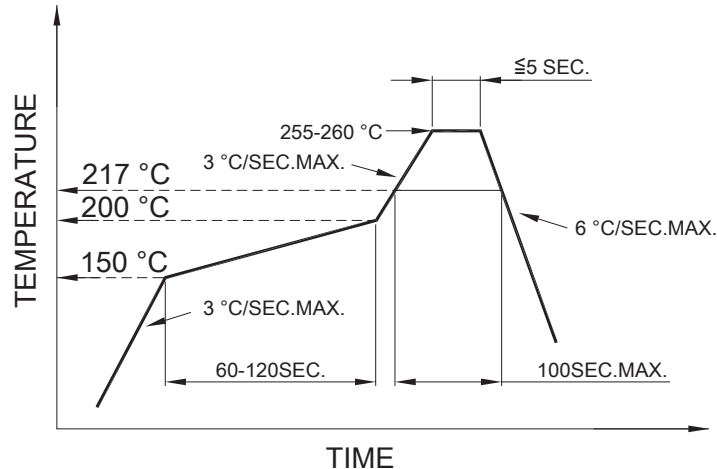

- We recommend the reflow temperature 245°C / 473°F (+/- 5°C / 41°F). The maximum soldering temperature should be limited to 260°C / 500°F.
- Number of reflow process shall be 2 time or less.
- Soldering Iron**
Basic spec is ≤ 4 sec when 260°C / 500°F. If temperature is higher, time should be shorter (+10°C / 50°F \rightarrow 1 sec). Power dissipation of Iron should be smaller than 15W, and temperature should be controllable. Surface temperature of the device should be under 230°C / 446°F.
- Rework**
 - Customer must finish rework within 3 sec. under 350°C / 662°F.
 - The head of soldering iron cannot touch copper foil.

Storage Condition

In factory original sealed bag package

| TEMPERATURE CONDITION | HUMIDITY CONDITION |
|-----------------------|--------------------|
| 5°C ~ 30°C | Below 60%RH |

After opened and not in factory original sealed bag package

| TEMPERATURE CONDITION | HUMIDITY CONDITION | STORAGE TIME |
|-----------------------|--------------------|----------------------------------|
| 5°C ~ 30°C | Below 60%RH | Within 4 weeks (MSL as level 2a) |

Tape & Reel Dimensions

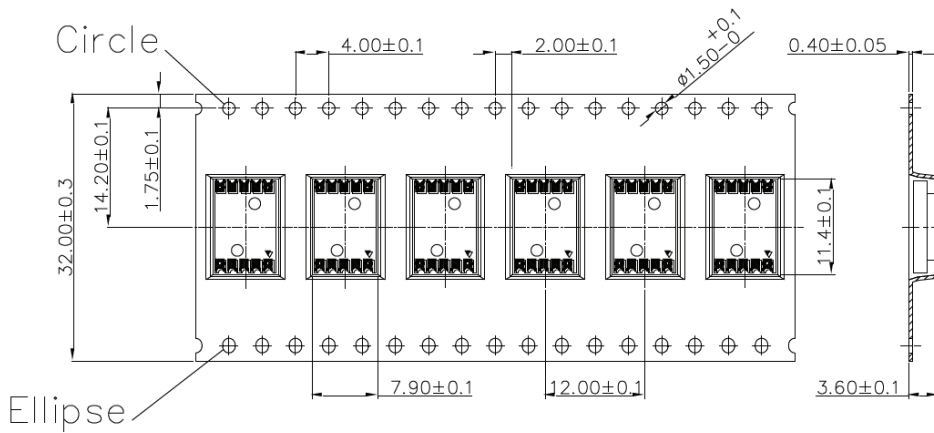
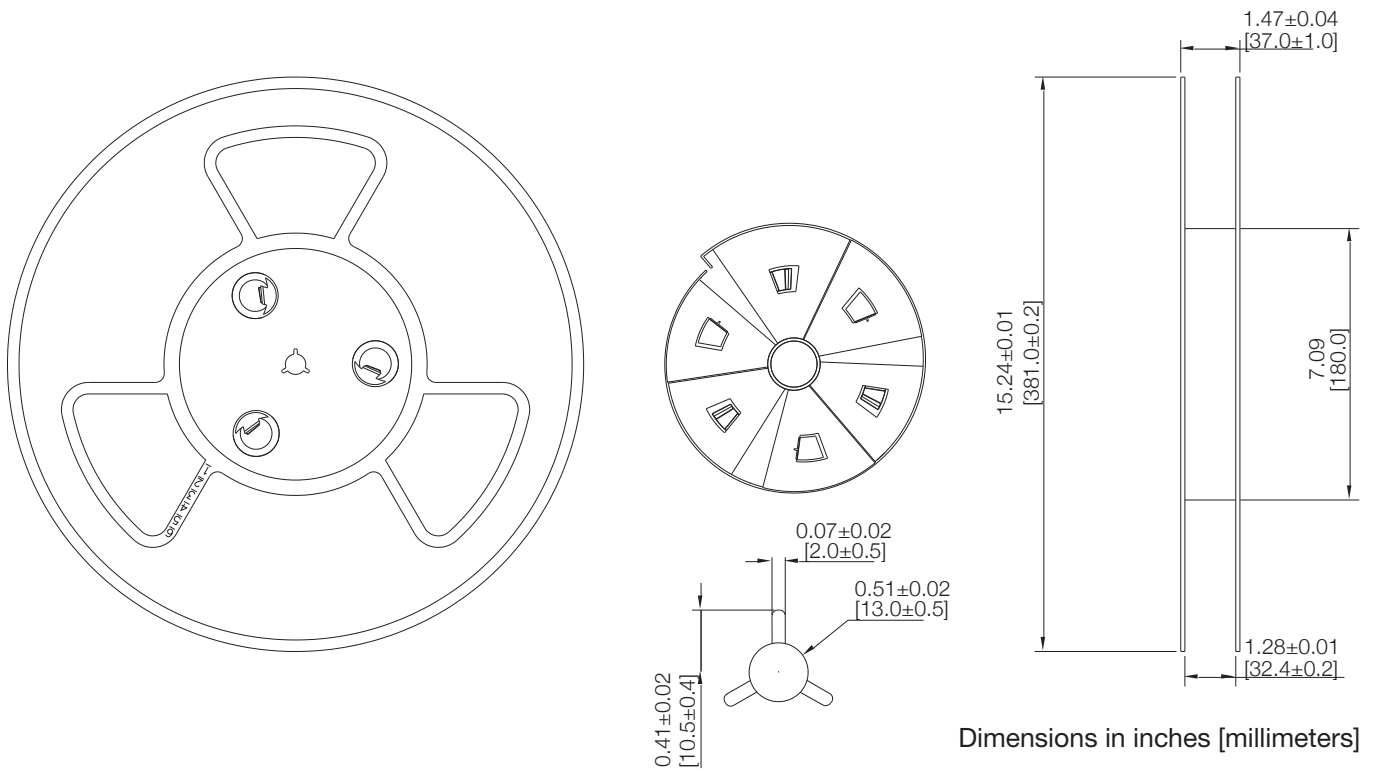

1350PCS / 1 REEL

Dimensions in millimeters

Compliance and Approvals



X-ON Electronics

Largest Supplier of Electrical and Electronic Components

Click to view similar products for [LED Displays & Accessories](#) category:

Click to view products by [Visual Communications Company](#) manufacturer:

Other Similar products are found below :

[LTC-2721WC](#) [LTC-4624JD](#) [LTC-4627WC](#) [LTC-571P](#) [LTD-5021AWC](#) [LTM-8522G](#) [LTP-4323P](#) [LTP-747G](#) [LTS-3361JG-06](#) [ELS-316SYGWA/S530-E2](#) [1668](#) [HT-F196NB-5323](#) [IPD2131-27](#) [SA03-12EWA](#) [LDQ-N514RI](#) [LDS-A3506RD](#) [LDS-A3926RI](#) [SC03-12HDB](#) [SI-B9T151550WW](#) [SI-B9V171550WW](#) [SLC-3PF-WL](#) [SLDN-32M-G](#) [1624](#) [LTC-2623WC](#) [LTC-4627JD](#) [LTD-322G](#) [LTD-482PC](#) [LTP-1057AHR](#) [LTP-1457AKR](#) [LTP-3784G-01](#) [LTS-313AP](#) [LTS-4812SKR-P](#) [LTS-547AE](#) [LTS-6780P](#) [446010401-3](#) [DA43-11GWA](#) [LDD-A516RI-17](#) [LDD-E305RI](#) [LDQ-N3402RI](#) [LDQ-N3606RI](#) [LDT-M2804RI](#) [86004CB830](#) [LTP-3862JD](#) [LTP-2088AKD](#) [LTD-6740P](#) [LTS-6880Y](#) [LDS-SMC3002RISUGTR](#) [LTC-2623E](#) [CC25-12YWA](#) [LDM-6432-P3-UR-1](#)