

DSM Series Ultra Thin Surface Mount Single Digit 7-Segment LED Display

DSM7UA56101 - 0.56" (14.22mm) Digit Height
Emitting Color: Red (AlGaInP/GaAs)

Applications

- People Movers
- Home Appliances
- Medical Devices
- Industrial Devices
- Automation and Controls
- Light Control
- IoT
- Transportation
- Food Service Appliances

Key Features

- 1-digit seven segment led numeric display
- Outer dimensions: 20.0 x 12.50 x 2.1mm
- Reduce overall thickness of PCB, with major cost savings
- Available in 4 different digit heights and widths
- Excellent character appearance, with high light output
- Super bright red chip
- Made from AlGaInP on transparent GaAs substrate
- Made of white segments and gray surface
- Also available in pure green
- Available in cut tape or automation-friendly tape and reel
- Exclusive patented technology
- Low current operation and lower power consumption
- Polarity: common anode
- Available for reverse mounting configuration
- Side by side mounting allows space saving
- Easy mounting on PC boards or sockets
- Moisture Sensitive Level (MSL): 2a
- Life expectancy: 100,000 hours
- Technically and mechanically rugged
- Quality tested with the highest industry standard

Ordering Data

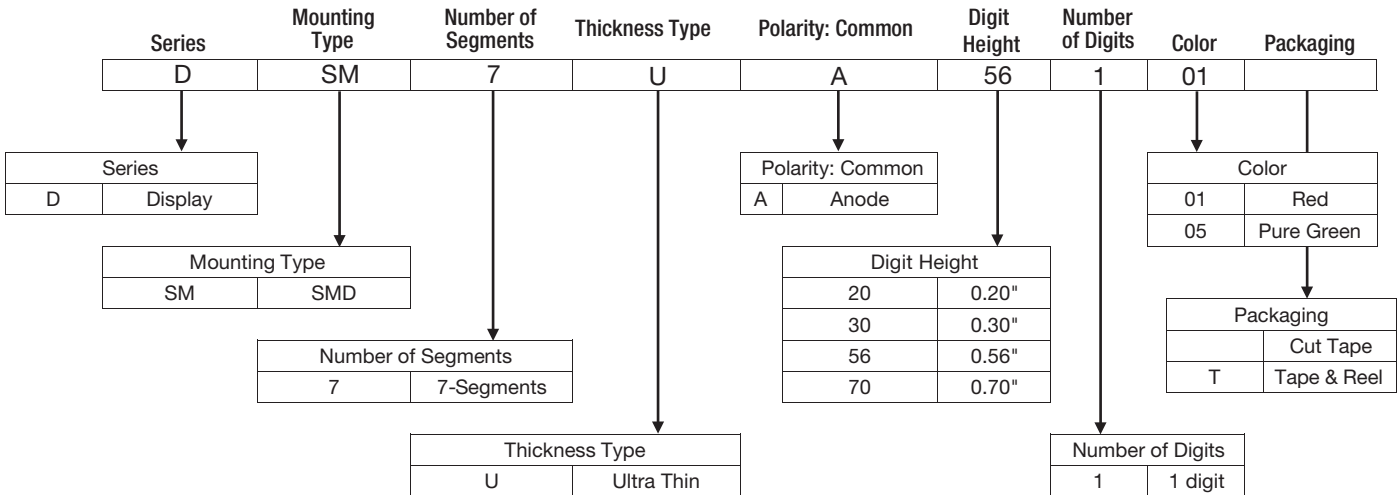

Dimensions and Internal Circuit Diagram

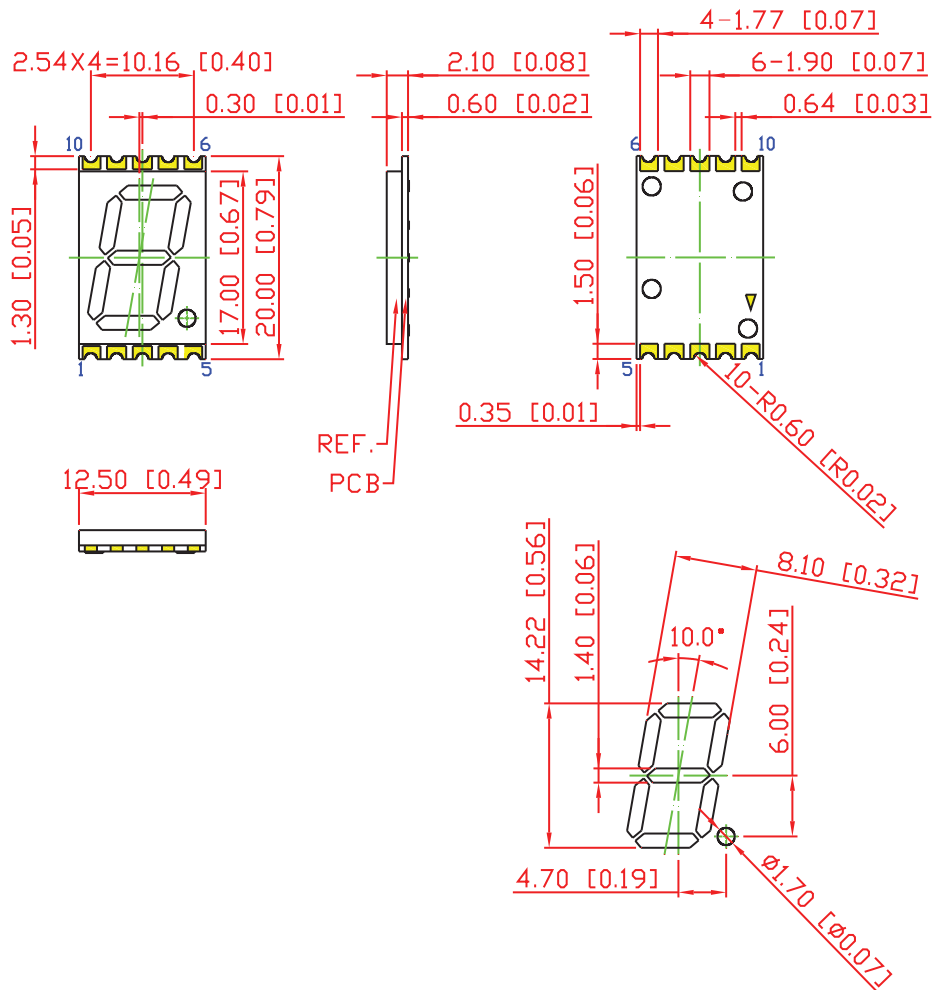

Dimensions in millimeters [inches]
Tolerance is $\pm 0.25\text{mm}$ [0.01"] unless otherwise noted

Dimensions and Internal Circuit Diagram

Recommended Reverse Mount Solder Pattern

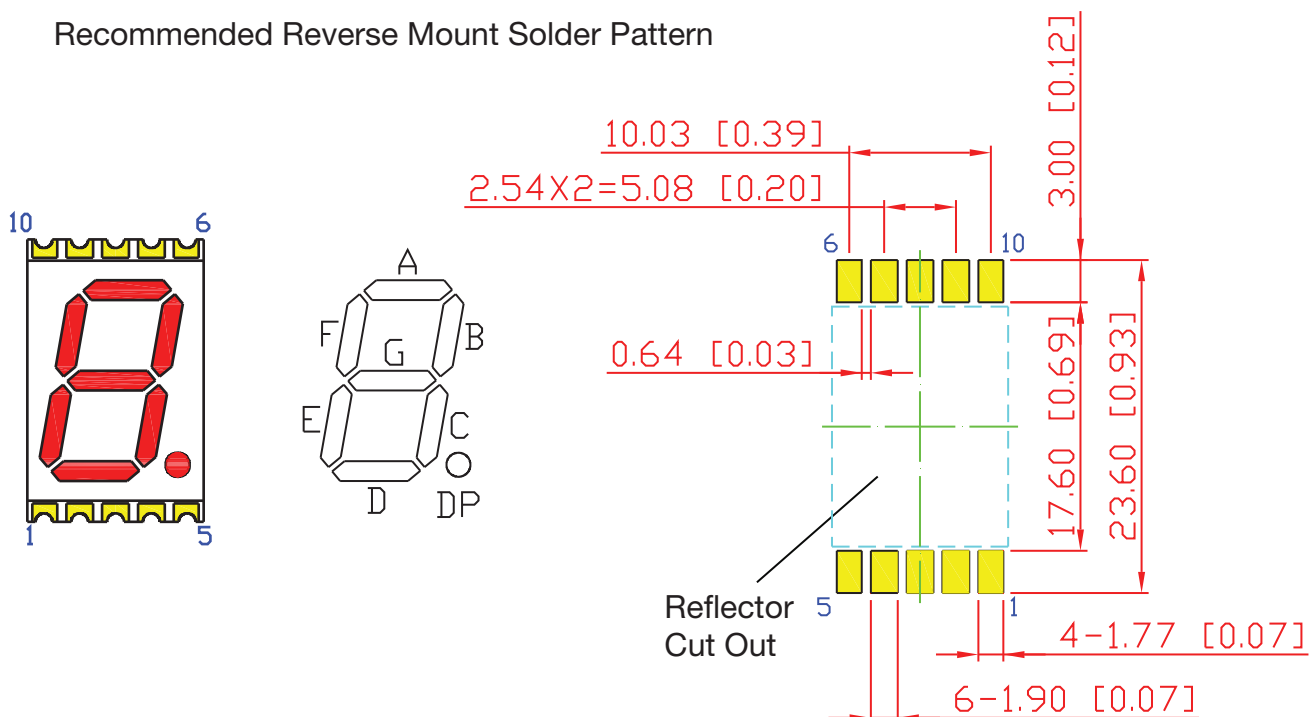

Dimensions in millimeters [inches]

Tolerance is $\pm 0.25\text{mm}$ [0.01"] unless otherwise noted

Pin Connections (Common Anode)

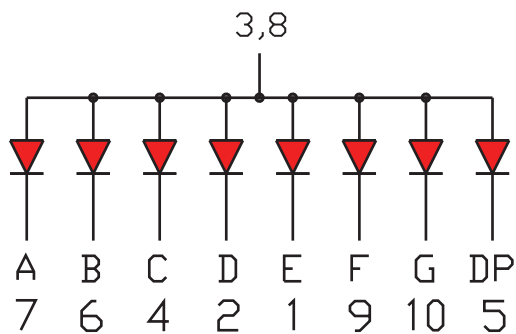

PIN No	Connection
1	CATHODE E
2	CATHODE D
3	COMMON ANODE
4	CATHODE C
5	CATHODE DP
6	CATHODE B
7	CATHODE A
8	COMMON ANODE
9	CATHODE F
10	CATHODE G

Product Specifications

Absolute Maximum Rating at Ta=25°C / 77°F (Ta= Ambient Temperature)

Parameter	Symbol	Maximum Rating	Unit
Power dissipation	P _{AD}	70	mW
Derating liner from 25°C/77°F	-	0.28/9.46	mA °C / °F
Continuous forward current	I _{AF}	25	mA
Peak current (duty cycle 1/10, 1kHz)	I _{PF}	90	mA
Reverse voltage	V _R	5	V
Operating temperature	T _{OPR}	-40 TO +105 -40 TO +221	°C °F
Storage temperature	T _{STG}	-40 TO +105 -40 TO +221	°C °F

Electrical - Optical Characteristics at Ta=25°C / 77°F (Ta= Ambient Temperature)

Charateristic	Symbol	Condition	Min.	Typ.	Max.	Unit
Forward Voltage, (Per Dice)	V _F	I _F =20mA	-	2.0	2.6	V
Reverse Current, (Per Dice)	I _R	V _R =5V	-	-	10	μA
Peak Wavelength	λ _P	I _F =20mA	-	632	-	nm
Dominant Wavelength	λ _D	I _F =20mA	619	-	629	nm
Luminous Intensity	I _V	I _F =20mA	10	-	40	mcd
Spectral radiation bandwidth	Δλ	I _F =20mA	-	20	-	nm

Product Specifications

Typical Electro-optical Characteristic Curves

(25°C / 77°F Free Air Temperature Unless Otherwise Specified)

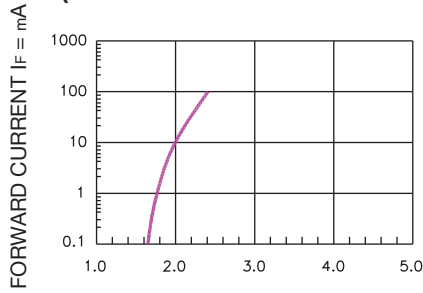

FORWARD CURRENT I_F (mA)
FORWARD VOLTAGE V_F (V)
FORWARD CURRENT VS. FORWARD VOLTAGE

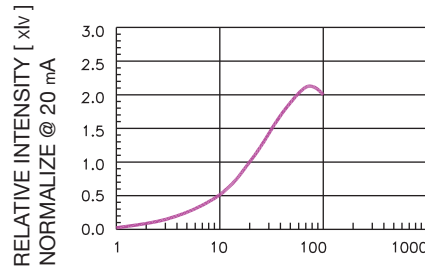

RELATIVE INTENSITY [xlv]
NORMALIZE @ 20 mA
FORWARD CURRENT I_F (mA)
RELATIVE INTENSITY VS. FORWARD CURRENT

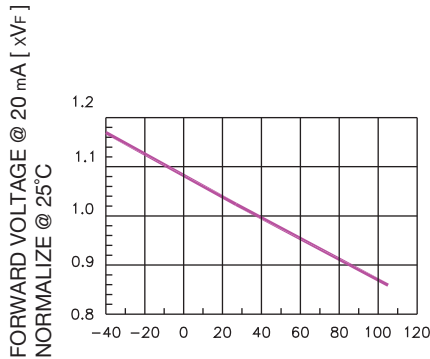

FORWARD VOLTAGE @ 20 mA [xV]
NORMALIZE @ 25°C
AMBIENT TEMPERATURE T_a (°C)
FORWARD VOLTAGE VS. TEMPERATURE

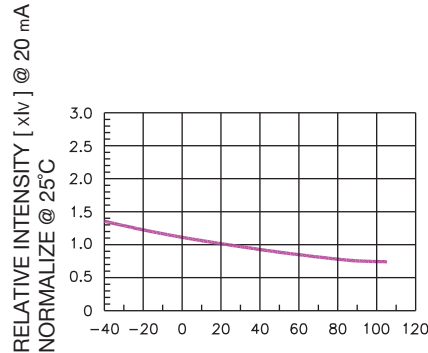

RELATIVE INTENSITY [xlv] @ 20 mA
NORMALIZE @ 25°C
AMBIENT TEMPERATURE T_a (°C)
RELATIVE INTENSITY VS. TEMPERATURE

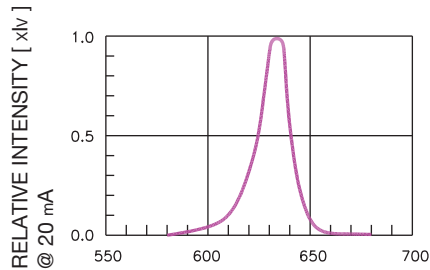

RELATIVE INTENSITY [xlv]
@ 20 mA
WAVELENGTH (nm)
RELATIVE INTENSITY VS. WAVELENGTH

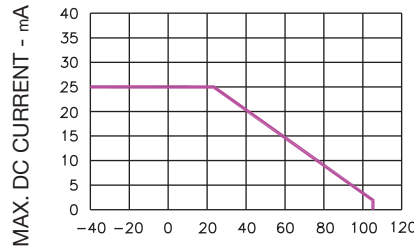

MAX. DC CURRENT - mA
AMBIENT TEMPERATURE T_a (°C)
MAX. ALLOWABLE DC CURRENT VS. AMBIENT TEMPERATURE

Circuit Design Notes

- Always use current limit resistors when necessary
- LEDs could be electrically connected in parallel, with each LED having its own current limiting resistor

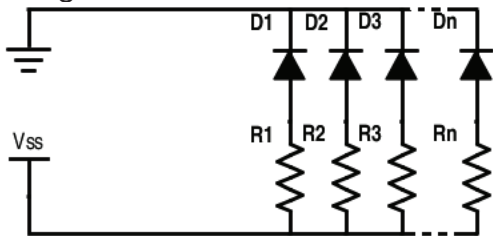

Correct

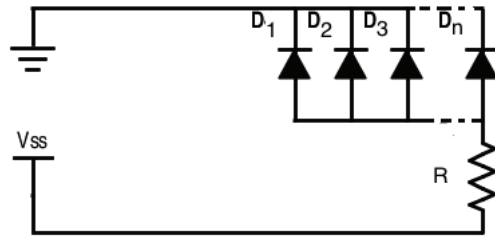

Incorrect

Recommended Reflow Soldering Profile

- SMT Reflow Soldering Instructions

SMT Soldering Profile
Pb free reflow soldering Profile

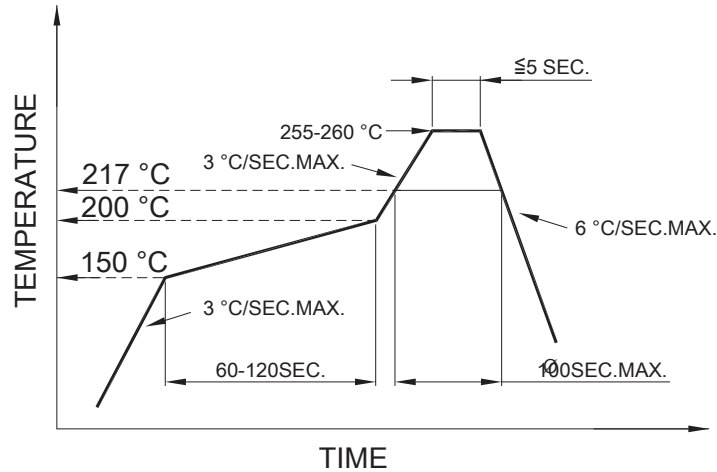

- We recommend the reflow temperature 245°C / 473°F (+/- 5°C / 41°F). The maximum soldering temperature should be limited to 260°C / 500°F.

- Number of reflow process shall be 2 time or less.

- Soldering Iron**

Basic spec is ≤ 4 sec when 260°C / 500°F. If temperature is higher, time should be shorter (+10°C / 50°F \rightarrow 1 sec). Power dissipation of Iron should be smaller than 15W, and temperature should be controllable. Surface temperature of the device should be under 230°C / 446°F.

- Rework**

- Customer must finish rework within 3 sec. under 350°C / 662°F.
- The head of soldering iron cannot touch copper foil.

Storage Condition

In factory original sealed bag package

TEMPERATURE CONDITION	HUMIDITY CONDITION
5°C ~ 30°C	Below 60%RH

After opened and not in factory original sealed bag package

TEMPERATURE CONDITION	HUMIDITY CONDITION	STORAGE TIME
5°C ~ 30°C	Below 60%RH	Within 4 weeks (MSL as level 2a)

Tape & Reel Dimensions

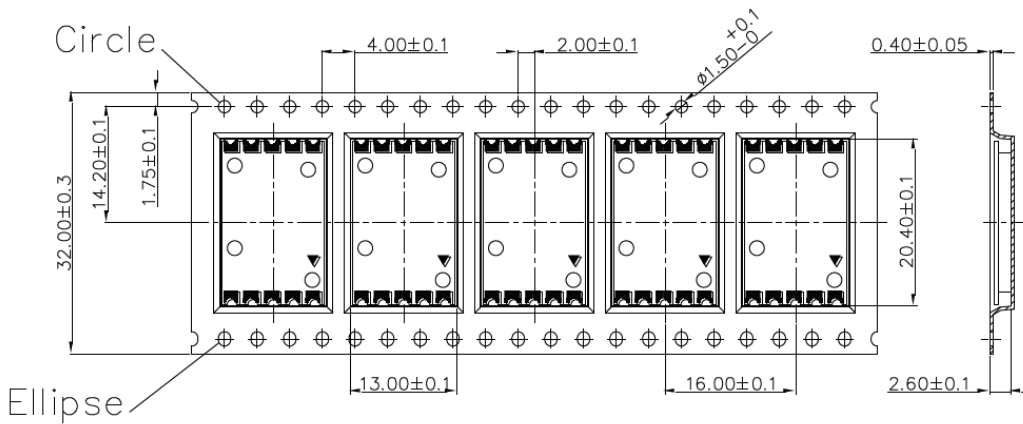
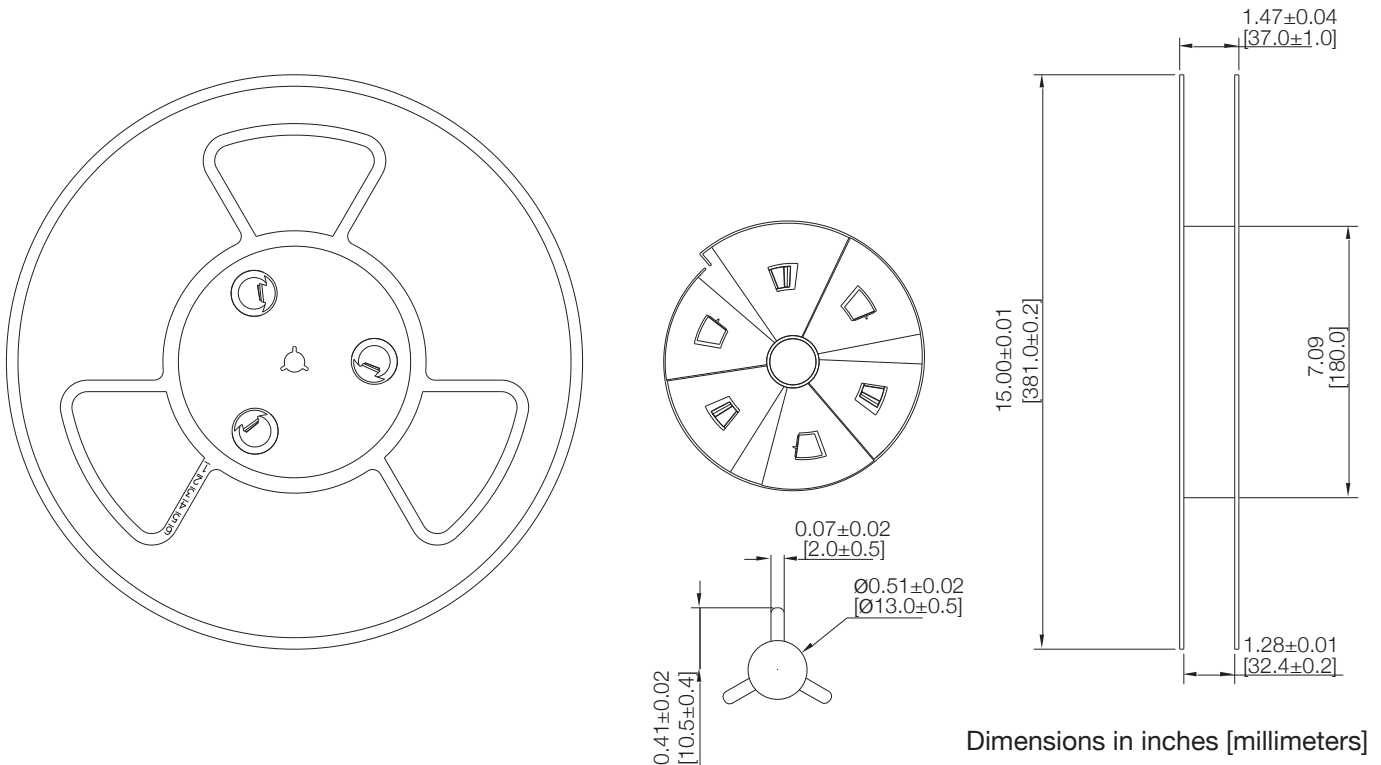

1300PCS / 1 REEL

Dimensions in millimeters

Compliance and Approvals



X-ON Electronics

Largest Supplier of Electrical and Electronic Components

Click to view similar products for [LED Displays & Accessories](#) category:

Click to view products by [Visual Communications Company](#) manufacturer:

Other Similar products are found below :

[LTC-2721WC](#) [LTC-4624JD](#) [LTC-4627WC](#) [LTC-571P](#) [LTD-5021AWC](#) [LTM-8522G](#) [LTP-4323P](#) [LTP-747G](#) [LTS-3361JG-06](#) [ELS-316SYGWA/S530-E2](#) [1668](#) [HT-F196NB-5323](#) [IPD2131-27](#) [SA03-12EWA](#) [LDQ-N514RI](#) [LDS-A3506RD](#) [LDS-A3926RI](#) [SC03-12HDB](#) [SI-B9T151550WW](#) [SI-B9V171550WW](#) [SLC-3PF-WL](#) [SLDN-32M-G](#) [1624](#) [LTC-2623WC](#) [LTC-4627JD](#) [LTD-322G](#) [LTD-482PC](#) [LTP-1057AHR](#) [LTP-1457AKR](#) [LTP-3784G-01](#) [LTS-313AP](#) [LTS-4812SKR-P](#) [LTS-547AE](#) [LTS-6780P](#) [446010401-3](#) [DA43-11GWA](#) [LDD-A516RI-17](#) [LDD-E305RI](#) [LDQ-N3402RI](#) [LDQ-N3606RI](#) [LDT-M2804RI](#) [86004CB830](#) [LTP-3862JD](#) [LTD-6740P](#) [LTS-6880Y](#) [LDS-SMC3002RISUGTR](#) [LTC-2623E](#) [CC25-12YWA](#) [LDM-6432-P3-UR-1](#) [SR420312N/32](#)