

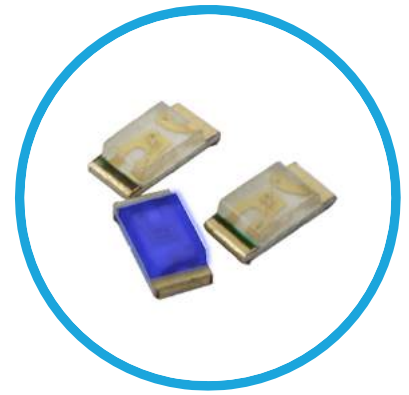

LSM0603 Series

0603 SMD LED packages

1.6 x 0.8 x 0.40 mm LED Lamp



LSM0603463V Blue SMD LED. High intensity light output, low power consumption, low profile and wide viewing angle.

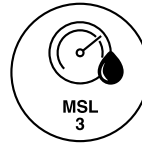
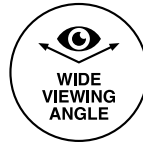
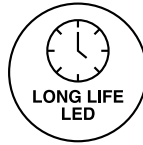
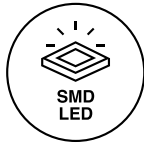

Application

- Wearable Device
- Automotive Features
- Navigations Systems
- Home and Smart Appliances
- Backlit Keypads
- Medical
- Health Care Application
- IoT
- Industrial Control Systems

Key features

- 1.6 mm x 0.8 mm (0603 package/1608 metric) Chip SMD LED
- 0.40 mm in thickness
- Low power consumption
- Rectangle flat top LED
- Wide viewing angle (120°)
- Optimized light coupling by inter reflector
- GaInP technology
- Available in a range of colors: red, white, green, blue and yellow making it ideal for status indication
- Cost-efficient solution for low-power and compact electronic equipment designs
- Compatible with automatic placement equipment and available in automation-friendly tape and reel
- Ideal for special configurations for automated PC board assembly and space-sensitive applications
- Pb-free
- Moisture sensitivity level: 3
- Package 4,000 pieces per reel
- Compliant with RoHS and REACH

Ordering Data

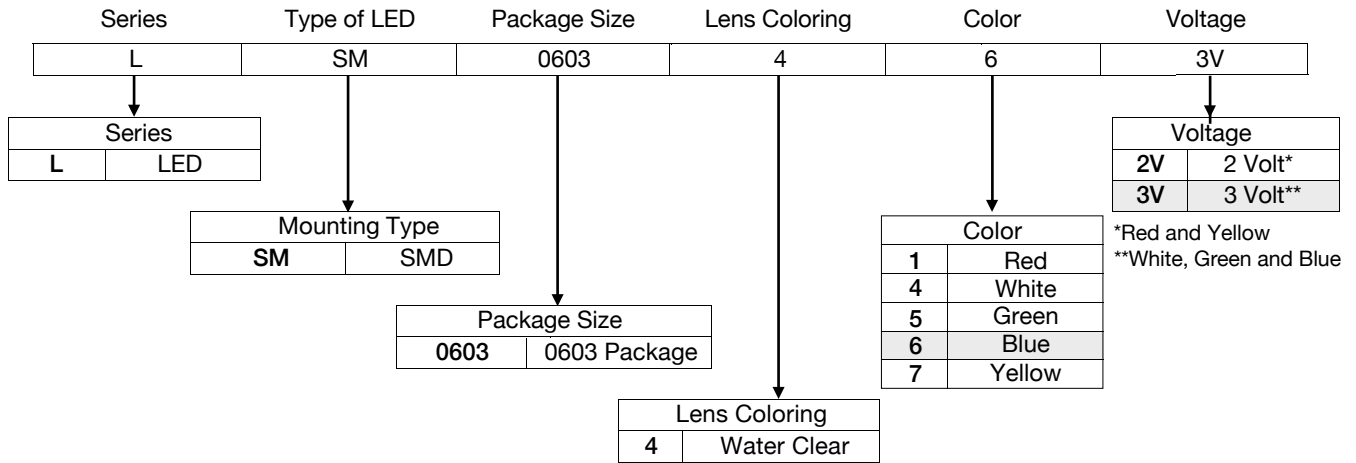

Package Dimensions

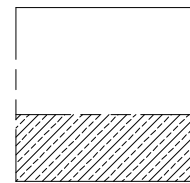
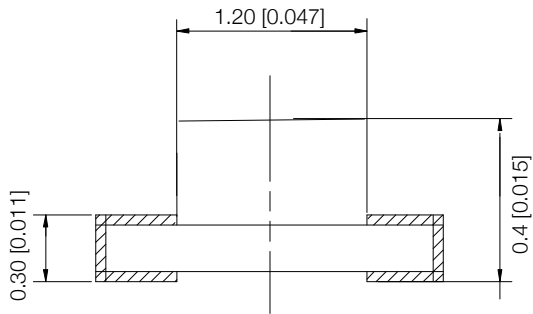
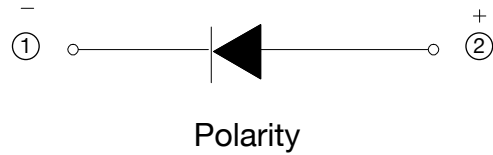
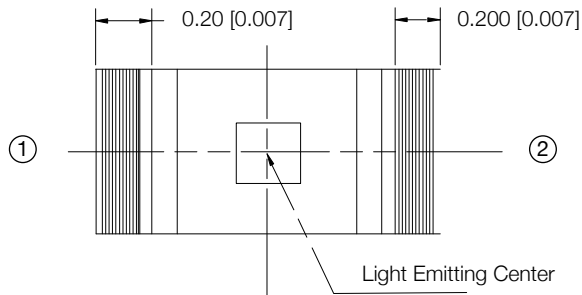

Recommended Soldering Pattern

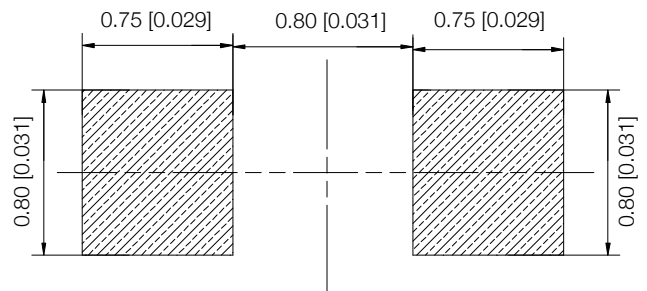
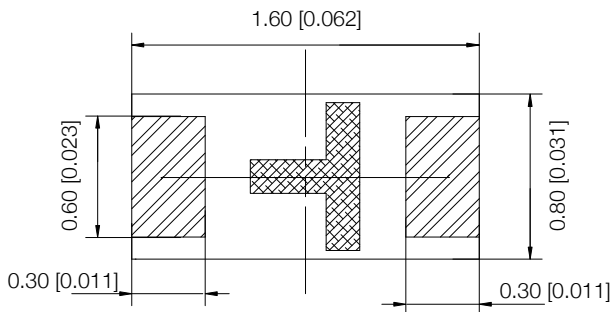

Note: The tolerance unless mentioned is $\pm 0.1\text{mm}$ [0.005 in] ; Unit=mm [in]

Product Specifications

Absolute Maximum Ratings (ta=25°C)

Items	Symbol	Ratings	Unit
Reverse Voltage	VR	5	V
Forward Current	If	20	mA
Operation Temperature	Topt	-40~+85	°C
Storage Temperature	Tstg	-40~+100	°C
Electrostatic Discharge (HBM)	ESD	2000	V
Power Dissipation	Pt	80	MW
Peak Forward Current (Duty 1/10 @1KHZ)	IFP	70	MA
Soldering Temperature	Tsol	Reflow Soldering: 260°C for 10 sec	

Parameter	Symbol	Min	Typ.	Max.	Unit	Condition
Luminous Intensity	Iv	15	--	25	mcd	IF=20mA
Peak Wavelength	λP	--	469	-	nm	IF=20mA
Dominant Wavelength	λd	468	-	470	nm	IF=20mA
Spectrum Radiation Bandwidth	$\Delta\lambda$	--	20	-	nm	IF=20mA
Forward Voltage	V _F	2.8	3.0	3.4	v	IF=20mA
Viewing Angle	θ	-	120	-	deg	IF=20mA
Reverse Current	I _R	-	-	5	uA	V _R =5V

Note:

1. Tolerance of Luminous Intensity $\pm 3\%$
2. Tolerance of Dominant Wavelength $\pm 1\text{nm}$
3. Tolerance of Forward Voltage $\pm 0.03\text{V}$

Product Specifications

Typical Electrical-Optical Characteristics Curves

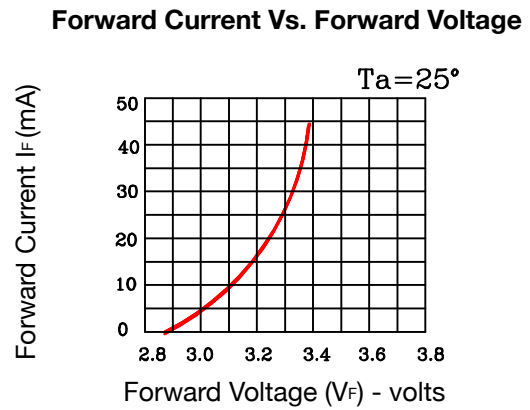
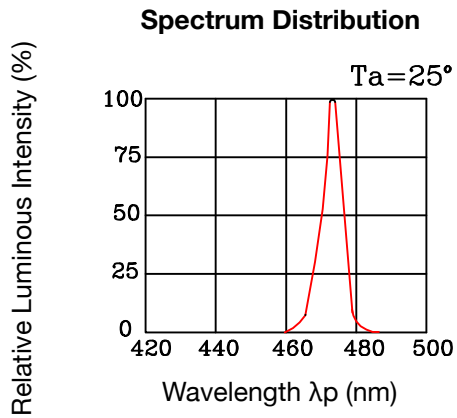

Luminous Intensity Vs. Ambient Temperature

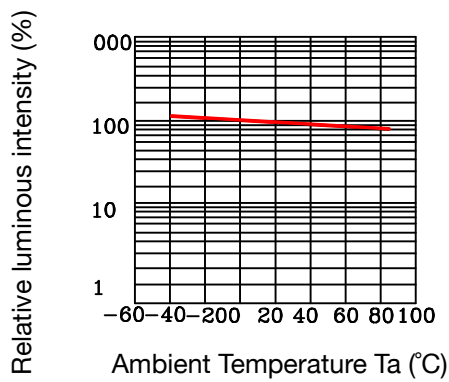

Luminous Intensity Vs. Forward Current

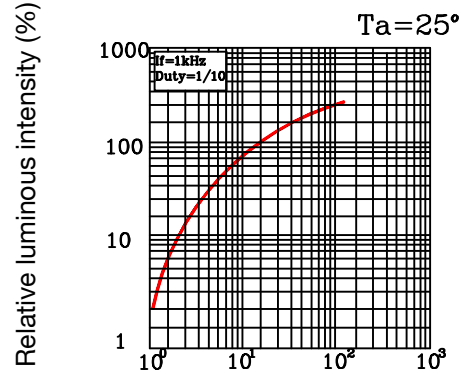

Forward Current Derating Curve

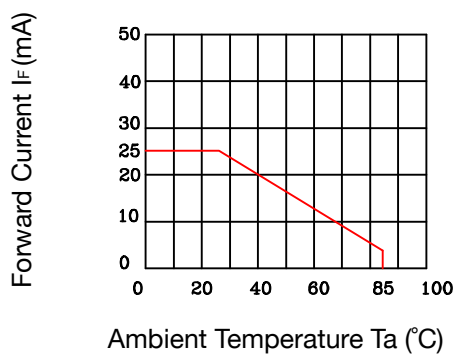

Forward Current I_F (mA) Radiation Diagram

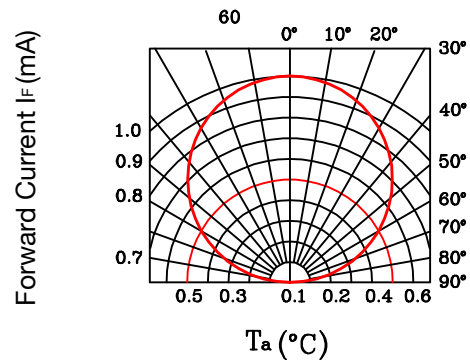

Reliability Data

The reliability of products shall be satisfied with items listed below. Confidence level: 90%

LTPD: 10%

No	Items	Test Condition	Test Hours/Cycles	Sample Size	Ac/Re
1	Reflow Soldering	Temp: 260±5°C	6 min	22 PCS	0/1
2	Temperature Cycle	H: +100°C 15 min ∫ 5 min L: -40°C 15 min	300 Cycles	22 PCS	0/1
3	Thermal Shock	H: +100°C 5 min ∫ 10 sec L: -10°C 5 min	300 Cycles	22 PCS	0/1
4	High Temperature Storage	Temp: 100°C	1000 Hrs	22 PCS	0/1
5	Low Temperature Storage	Temp:-40°C	1000 Hrs	22 PCS	0/1
6	DC Operating Life	IF=20mA	1000 Hrs	22 PCS	0/1
7	High Temperature High Humidity	85°C/85%RH	1000 Hrs	22 PCS	0/1

Recommended Reflow Soldering Profile

• Reflow Soldering

Use the conditions shown in the figure below for PB-Free Reflow Soldering.

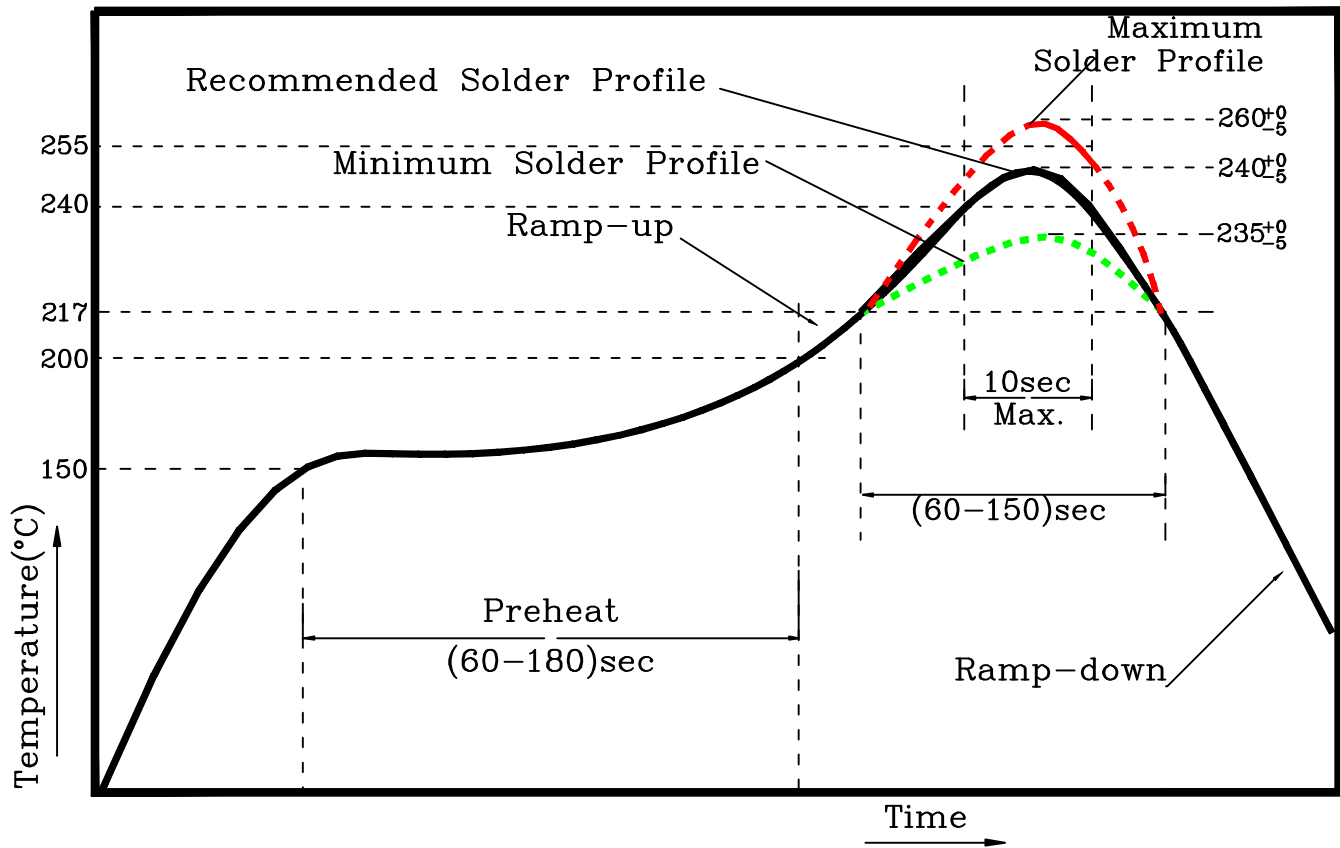

- Reflow soldering should not be done more than two times.
- Stress on the LEDs should be avoided during heating in soldering process.
- After soldering, do not handle the product before its temperature drops down to room temperature.

Precautions

• Storage

Moisture proof and anti-electrostatic package with moisture absorbent material are used, to keep moisture to a minimum.

Before opening the package, the product should be kept at 30°C or less and humidity less than 60%Rh, and be used within a year.

Afer opening the package, the product should be stored at 30°C or less and humidity less than 10%RH, and be soldered within 24 hours. It is recommended that the product be operated at the workshop condition of 30°C or less and humidity less than 60%RH.

If the moisture absorbent material has faded away or the LEDs have exceeded the storage time. Baking should be performed based on the following condition: (60+5C) for 12 hours.

• Static Electricity

Static electricity or surge voltage damages the LEDs. Damaged LEDs will show some unusual characteristics such as the forward voltage becomes lower, or the LEDs do not light at the low current, even not light.

All devices, equipment, and machinery must be properly grounded. At the same time, it is recommended that wristbands or anti-electrostatic gloves, anti-electrostatic containers be used when dealing with the LEDs.

Circuit Design Notes

• Design Consideration

In designing a circuit, the current through each LED must not exceed the absolute maximum rating specified for each LED. In the meanwhile, resistors for protection should be applied, otherwise slight voltage shift will cause big current change, burn out may happen.

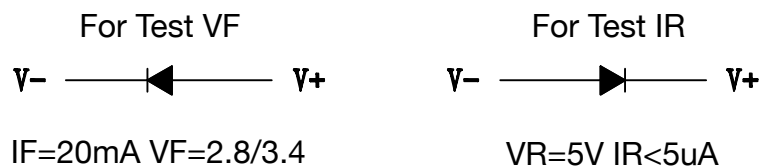

• Thermal Design

Is paramount importance because heat generation may result in the Characteristics decline, such as brightness decreased, Color changed and so on. Please consider the heat generation of the LEDs when making the system design.

Tape and Reel Specifications

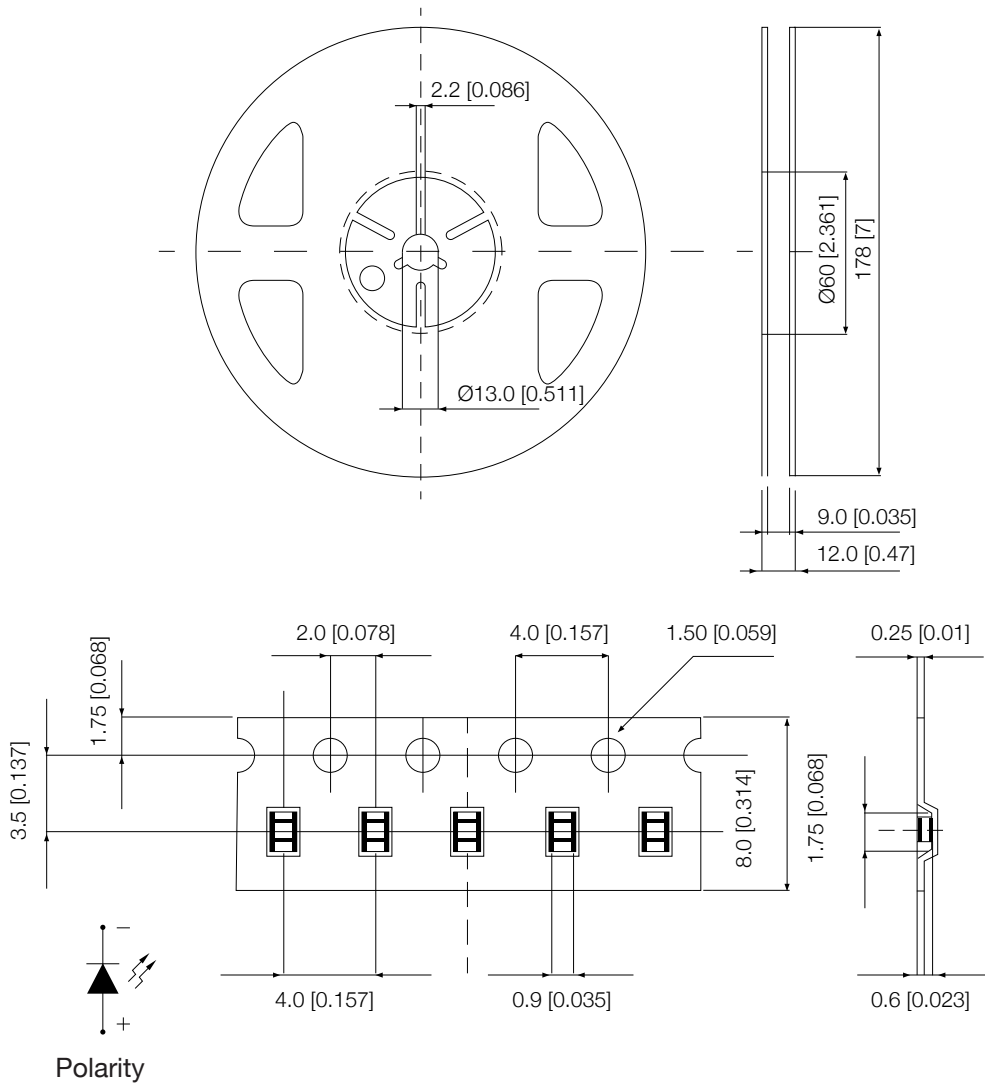

Note: The tolerance unless mentioned is $\pm 0.1\text{mm}$ [0.005 in] ; Unit=mm [in]

Compliances and Approvals



X-ON Electronics

Largest Supplier of Electrical and Electronic Components

Click to view similar products for [Standard LEDs - SMD category](#):

Click to view products by [Visual Communications Company manufacturer](#):

Other Similar products are found below :

[LTST-C19GD2WT](#) [LTST-N683GBEW](#) [LTW-170ZDC](#) [LTW-M140SZS40](#) [598-8110-100F](#) [598-8170-100F](#) [598-8610-202F](#) [67-22VRVGC/TR8](#) [AAAF5060QBFSEEZGS](#) [HLMP-6305-L0011](#) [ALMD-LB36-SV002](#) [APT1608QGW](#) [15-21UYC/S530-A3/TR8](#) [EASV1803BA0](#) [LS A676-P2S1-1](#) [SML310BATT86](#) [SML-512VWT86A](#) [SML-LX0606SISUGC/A](#) [SML-LXL1307SRC-TR](#) [SML-LXR851SIUPGUBC](#) [LT1ED53A](#) [FAT801-S](#) [AM27ZGC03](#) [APB3025SGNC](#) [APFA3010SURKCGKQBDC](#) [APHK1608VGCA](#) [APT2012QGW](#) [CLX6D-FKB-CN1R1H1BB7D3D3](#) [LTST-C250KGKT](#) [LTW-020ZDCG](#) [LTW-21TS5](#) [LTW-220DS5](#) [JANTXM19500/521-02](#) [UYGT801-S](#) [LO T67F-V1AB-24-1](#) [YGFR411-H](#) [SML-LX0402IC-TR](#) [CMDA20AYAA7D1S](#) [CMDA16AYDR7A1X](#) [339-1SURYGW/S530-A2](#) [598-8040-100F](#) [598-8070-100F](#) [598-8140-100F](#) [598-8610-200F](#) [EAPL3527GA5](#) [67-11/BHC-M1N2B8Y/2A0](#) [SML-LXL1209SYC/ATR](#) [EASV3020YGA0](#) [EAST16086YA5](#) [CMD91-21VRC/TR7](#)