



LTH3MM12V Series

3mm (T-1) Through Hole LED

Built in Resistor for 12VDC



LTH3MM12VFR4400 - White Water-Clear T-1 (3 mm) LED

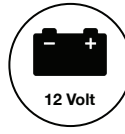

Applications

- Automotive
- Indoor and Outdoor Indication
- Industrial
- Appliances and Consumer Equipments
- Storage Servers
- Boats
- Railway
- Electronic Devices
- Residential and Landscape Lighting
- Infrastructure

Key Features

- Made with InGaN (White)
- Through-hole technology
- Integrated resistor for 12VDC operation
- With Flange
- Water-Clear Lens
- LED Bulb Size: 3mm (T-1), also available in 5mm (T-1 3/4)
- RoHS and REACH Compliant
- High-Brightness LED
- Available in 5 colors (red, green, white, blue and yellow)
- Viewing Angle: 30° (red, green, blue, yellow) and 35° (white)
- Moisture Sensitive Level (MSL): 2

Ordering Data

The LTH3MM12V Series is available in a range of standard features and options. To specify your LED, simply choose one option from each column.

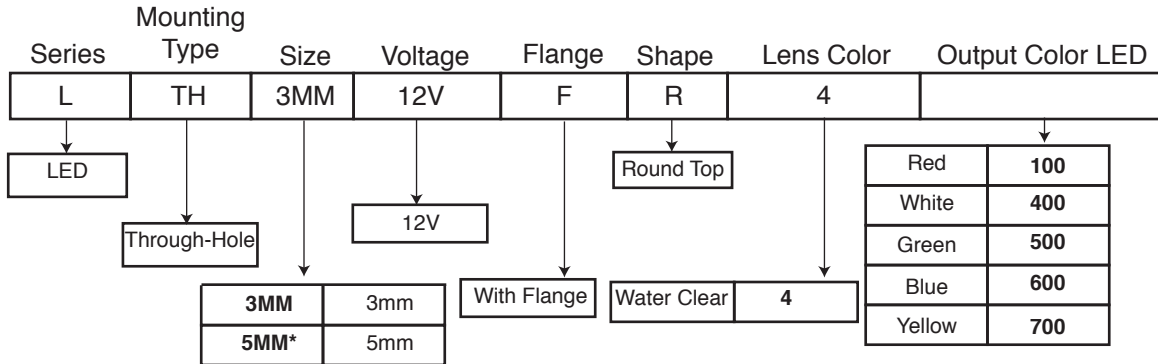

Part Numbers	Color
LTH3MM12VFR4100	Red
LTH3MM12VFR4400	White
LTH3MM12VFR4500	Green
LTH3MM12VFR4600	Blue
LTH3MM12VFR4700	Yellow

*For 5mm option, please consult LTH5MM12V Series' datasheet

Product Dimensions

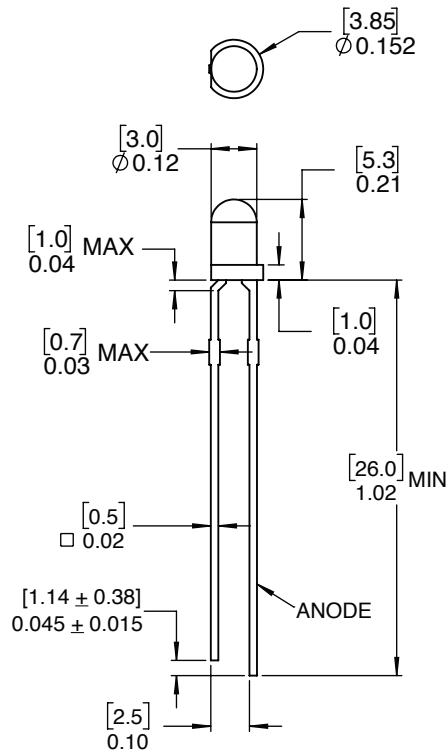

Notes:

1. All dimensions are in [millimeters] inches
2. Tolerance is $\pm[0.25]$ 0.01 unless otherwise noted.
3. The specifications, characteristics and technical data described in the datasheet are subject to change without prior notice

Product Dimensions

ABSOLUTE MAXIMUM RATINGS

(Ta=25°C)

Parameter	Symbol	Ratings	Unit
Peak Forward Current (duty 1/10 @ 1KHz)	I _{FP}	100	mA
Recommended Operating Current	I _{F(REC)}	20	mA
Power Dissipation	P _D	85	mW
Reverse Voltage	V _R	5	V
Electrostatic Discharge	ESD	200	V
Operating Temperature Range	T _{OPR}	-40~+85	°C
Storage Temperature Range	T _{STG}	-40~+100	°C
Lead Soldering Temperature Range 1.6mm (1/16 inch) from body	T _{SOL}	260°C for 5 seconds	

OPTICAL-ELECTRICAL CHARACTERISTICS

(Ta=25°C)

Parameter	Symbol	Test Condition	Min	Typ	Max	Unit
Luminous Intensity	I _v	I _F =10mA	2200	4000	6500	mcd
Chromaticity Coordinates	x		--	0.29	--	nm
	y		--	0.31	--	nm
Forward Voltage	V _F		10	12	13	V
Viewing Angle	2θ _{1/2}		--	35	--	deg
Reverse Current	I _R	V _R =5V	--	--	10	μA

Product Specifications

Typical Electrical-Optical Characteristic Curves

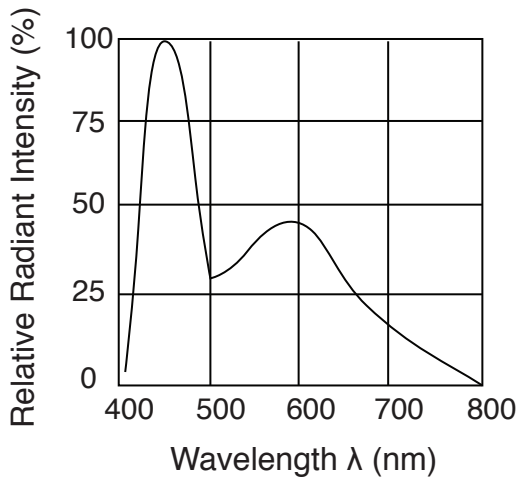

Relative Radiant Intensity vs. Wavelength

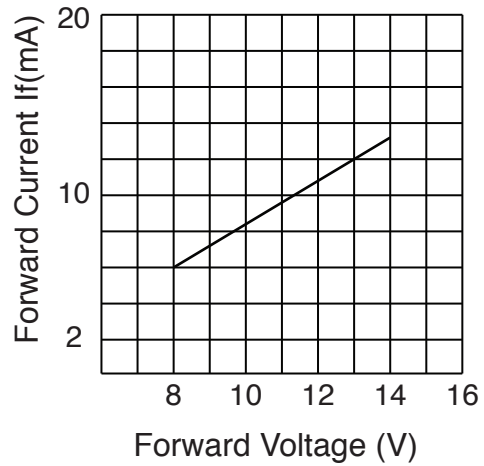

Forward Current vs. Forward Voltage

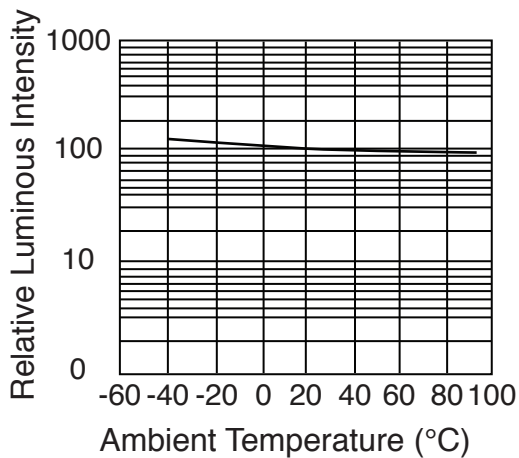

Relative Luminous Intensity vs. Ambient Temperature

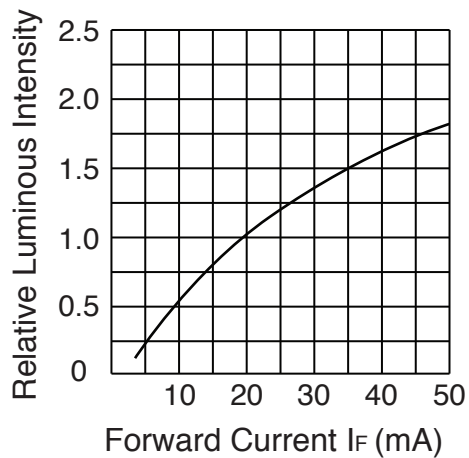

Relative Luminous Intensity vs. Forward Current

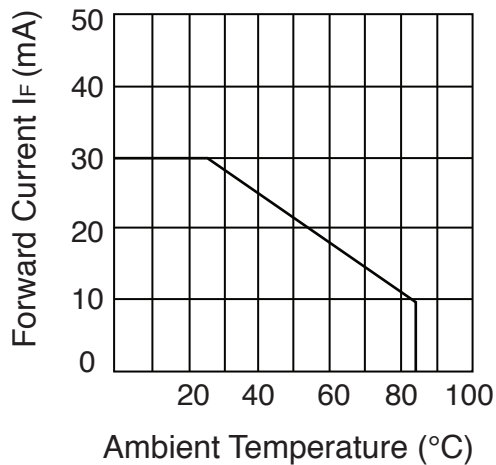

Forward Current Derating Curve

Application Notes

1. Storage

The Storage Temperature and RH are: 5°C ~ 30°C, RH 60% or less.

We suggest our customers use our products within a year.

If the moisture absorbent material (silica gel) has faded away or the LEDs exceeded the storage time, bake treat more than 24 hours at 60°C ±5°C.

2. Electrostatic Discharge (ESD)

Static electricity or surge voltage will damage the LEDs.

Recommendations: Use a conductive wrist band or anti-electrostatic glove when handling these LEDs. All devices, equipment and machinery must be properly grounded.

Work tables, storage racks, etc. should be properly grounded. In the event of a manual working in process, make sure the devices are well protected from ESD at any time.

3. Recommended Soldering Condition

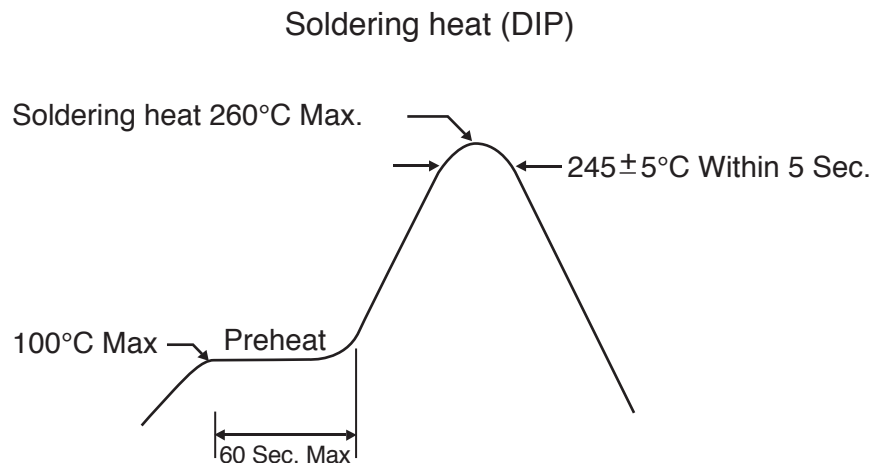

Temperature at tip of soldering iron: 350°C Max
Soldering time: 3 sec ±1 sec (once only)

Application Notes

4. Reflow Profile

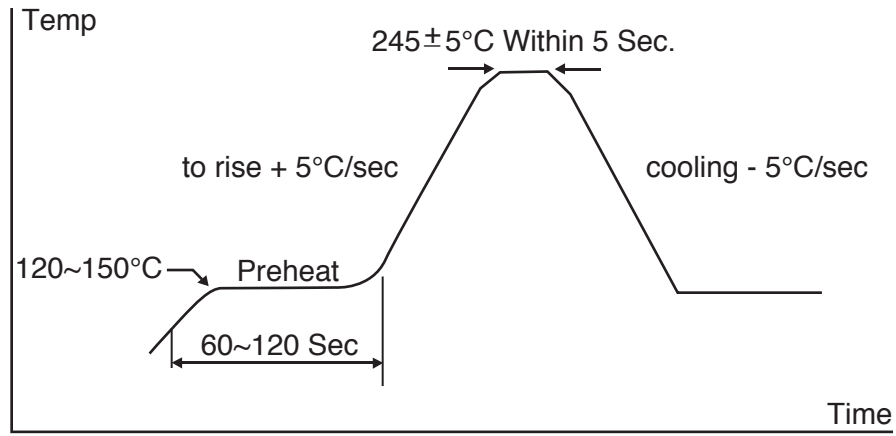

Compliances and Approvals



X-ON Electronics

Largest Supplier of Electrical and Electronic Components

Click to view similar products for [Standard LEDs - Through Hole category:](#)

Click to view products by [Visual Communications Company manufacturer:](#)

Other Similar products are found below :

[LTL-10254W](#) [LTL-1214A](#) [LTL-3251A](#) [LTL-4262N](#) [LTL-433P](#) [LTL-5234](#) [LTL87HTBK](#) [LTL-87HD4B](#) [HLMP-EL30-PS0DD](#)
[1L0532V23G0TD001](#) [NSPW500CS](#) [NTE30036](#) [NTE30044](#) [NTE30059](#) [NTE3020](#) [LD CQDP-1U3U-W5-1-K](#) [LO566UHR3-70G-A3](#)
[LP379PPG1C0G0300001](#) [SLX-LX3044GD](#) [SLX-LX3044ID](#) [SLX-LX3044YD](#) [1.90690.3330000](#) [SSS-LX4673ID-410B](#) [1L0532Y24I0TD001](#)
[264-7SYGD/S530-E2](#) [HLMP1385](#) [LTL-10224W](#) [LTL-1224A](#) [LTL-1234A](#) [LTL-2251AT](#) [LTL-307YE-012](#) [LTL-403HR](#) [LTL-4222](#) [LU7-E-](#)
[B](#) [4380H1](#) [TLHY44K1L2](#) [HLMP-3962-F0002](#) [HLMP-GG15-R0000](#) [323-2SURD/S530-A3](#) [L53SRC/E-Z](#) [L-7679C1ZGC](#) [4302T1-5V](#)
[4306D23](#) [4363D1/5](#) [WP1503SRC/J4](#) [WP153GDT](#) [WP153YDT](#) [WP1543SGC](#) [WP1543SURC](#) [WP53MGD](#)