

VITROHM

Customer Service + Factory

VITROHM PORTUGUESA
Resistências Electricas Lda.
Estrada Nacional 249, 4 Trajouce
P-2785-635 S. Domingos de Rana, Portugal
P : +351 21 445 77 - 00
F : +351 21 445 77 - 55

Sales + Marketing

YAGEO Europe GmbH
Ramskamp 70
D-25337 Elmshorn, Germany
P : +49 4121 870 - 103
F : +49 4121 870 - 289

Drawings, photos, text and layout are protected by copyright.

<http://www.vitrohm.com>

E-Mail: vitrohm.support@yageo.com

			<i>page</i>
Explanation of the Ordering Code			3
Terms and Explanations			4
Preferred values acc. to DIN/IEC			6
General			7
Pulse Load			11
Quality			19
Taping Specification			20
SMD	Power Resistors		
	series	RWN/RWC	Metal strip/ Wirewound 22
	series	RWP	Metal film 25
	series	RWF/RWS	Safety wirewound 27
Design Notes for Current Sense Resistors			29
Low Ohmic Power Resistors			
	series	KN	low inductance, axial 33
	series	KN	low inductance, radial 35
	series	KN	low inductance, ceramic case 37
	series	BWL	moulded 41
	series	SLR/SLP	ceramic metal plate 44
	series	LPS	current sensor 46
Insulated Wirewound Resistors			
	series	BW	moulded 52
	series	BWF	moulded, flame retardant, failsafe 55
Power Wirewound Resistors			
	series	KC	axial, coated, fibre glass core 60
	series	KP	radial, coated, fibre glass core 62
	series	KH	ceramic case, axial 64
	series	KV	ceramic case, vertical 66
	series	KT	vertical, circuit breaker, ceramic case, fibre glass core 68
	series	KF	axial, circuit breaker, ceramic case, fibre glass core 70
	series	KWA	ceramic case, AMP contacts 72
	series	KWP	ceramic case, radial 74
	series	KWP	Metox Element, ceramic case, radial 76
	series	KWV	ceramic case, vertical 78
	series	KWV	Metox Element, ceramic case, vertical 80
	series	CR	Precision, ceramic carrier, coated axial 82
	series	CRF	flame retardant, safety version 84
	series	RX	flameproof, coated, axial 86
	series	RE	Aluminium Housed, Chassis Mount 88
Mounting Brackets			
	series	S	Mounting Brackets Type S18141 90
Metalglaze film resistor			
	series	PO	Metaloxide, flame retardant 92
	series	RG	axial, hi-temp.-solder contacts, moulded, unflammable 96
	series	RGU	Metalglaze, moulded, vertical, unflammable 98
SMD	Metal Film Resistors		
	series	ZC	MELF Style.....100
Zero-Ohm			
	series	ZOM	moulded, Jumper.....105

Explanation :

Wirewound & Film Resistor

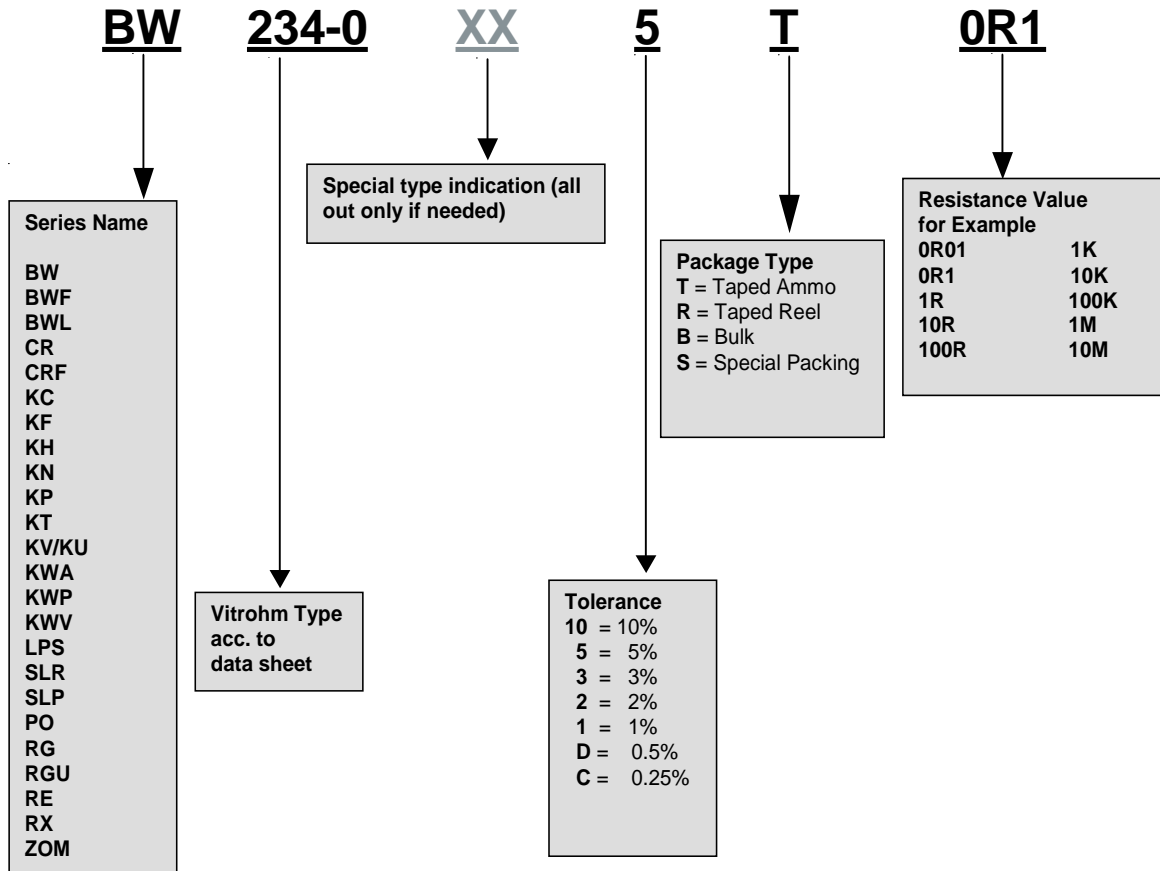

SMD Resistors

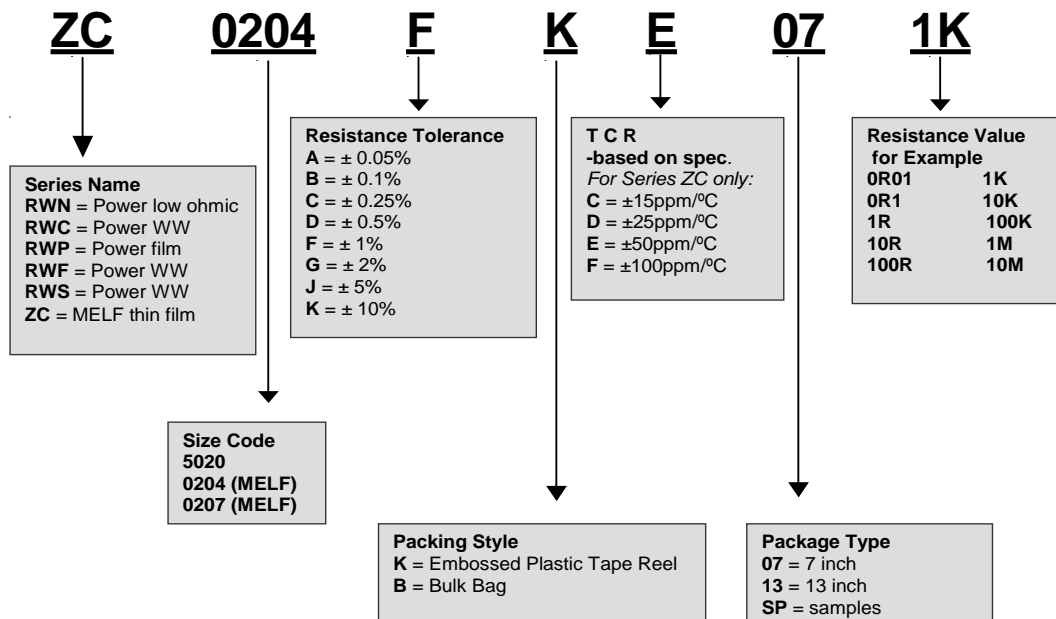

Type

Internal Vitrohm-reference for a certain component, normally identical with the ordering-number.
IEC 115-1 clause 2.2.2

Series

Collection of types with similar constructional features and comparable technical data.

Style

Industrialized, often internationally standardized, designation with respect to the dimensions of a component, e.g. length/width, diameter/length.
IEC 115-1 clause 2.2.3

Dimensions

The accurate mechanical size of a certain type or tabular for a series. If without tolerances, refer to DIN 7168 (coarse).

Rated Power P_{70}

Electrical power defined by current and voltage a resistor can bear continuously. Commonly the value is given for 70°C ambient temperature.
IEC 115-1 clause 2.2.13

Resistance range

Data, showing the minimum and maximum resistance value possible for a given type or series.

Series E of preferred values

Internationally standardized staggering for resistance values within one decade, different E-series vary on the total number of values per decade. The preferred values result (approximated) from

$$E \sqrt{10}^n \quad (n = 1, 2, 3 \dots E)$$

IEC 115-1 clause 2.3.2 and IEC 63

Tolerances

Here admissible deviation from nominal resistance value at the moment of receiving. Possible resistance changes due to electrical, climatic or mechanical stress are not included in the nominal tolerance.

Temperature coefficient

A value, determined by materials and styles, indicating the dependency of a resistance value from temperature. Resistance changes caused by temperature coefficient are reversible.
IEC 115-1 clauser 2.2.20.2 and 4.8.4.2

Voltage coefficient

A value mainly determined by materials, indicating the dependency between resistance value and applied voltage. The voltage coefficients is negative, resulting resistance changes are reversible.
IEC 115-1 clauses 2.2.25 and 4.11

Maximum continuous working voltage

Limit for the voltage applied to a resistor. May not be exceeded, even if other limitations, e.g. rated power, are not reached. If instead of a voltage value the general equation is given, the limiting voltage is only determined by the rated power.
IEC 115-1 clause 2.2.16

Thermal resistance

A value influenced by materials and dimensions indicating the selfheating of a resistor by electrical power.

Insulation voltage

Test voltage applied for one minute between components terminals and sheathing (e.g. surface). The given value does not define continuous isolation.
IEC 115-1 clause 2.2.17

Insulation resistance

Electrical resistance between components terminals and sheathing. Given for a certain measuring voltage, e.g. 100 V or 500 V.
IEC 115-1 clauses 2.2.19 and 4.6

Climatic category

Defined in IEC 68-1, this statement establishes the lowest and highest test temperature (category temperature) as well as the duration of humidity-testing. Consequently climatic category substitutes according to the CECC- and IEC-approval-systems the former applicability classes of DIN 40040, which were almost impossible to verify by testing.

Temperature range

Limits for ambient temperature. Components may be used within the stated limits.
IEC 115-1 clause 2.2.9

Derating

Reduction of electrical power at increased ambient temperature, to avoid excess of maximum surface temperature by selfheating.
IEC 115-1 clause 2.2.24

Failure rate

Number of statistically possible defects, depending on time and quantity of components. If not stated differently, the given value refers to total-failure under nominal conditions.

Load life

Relative irreversible resistance change after a certain testing time. Normally related to rated power 70°C ambient temperature and 1000 hours testing.
IEC 115-1 clause 4.25

Damp heat, steady state

Relative irreversible resistance change after a defined climatic stress.
IEC 115-1 clause 4.24

Climatic sequence

Relative irreversible resistance change after a defined sequence of climatic stresses.
IEC 115-1 clause 4.23

Terminal strength

Relative irreversible resistance change after a defined sequence of mechanical stresses to the terminals. Test procedures according to CECC or IEC are standardized in the applicable detailed specification.

Terminal tensile strength

Limit for the tensile force applied to the terminals.

Resistance to soldering heat

Relative irreversible resistance change due to soldering. Test procedures according to CECC or IEC are standardized in the applicable detailed specification.
IEC 115-1 clause 4.18

Current noise

A voltage, having a statistical distribution of frequencies, depending on the DC-current through the resistor. Current-noise-voltage is additional to thermal noise, which depends on materials and styles.
IEC 115-1 clause 4.12

Non-linearity

A value for possible non-linearity between current through and voltage applied to an ohmic resistor.

Standards

Here enumeration of norms and standard specifications, nationally or internationally known for a given series of components. If applicable also the CECC-detailed-specification to which the given series has been approved to.

Packaging units

Quantity packed in a standard packaging unit, method of packing, in cases possibilities of selection.

Ordering-example

Necessary order processing-details for required components.

E 6	E 12	E 24
1.0	1.0	1.0
		1.1
		1.2
1.5	1.5	1.3
		1.5
		1.6
		1.8
2.2	2.2	1.8
		2.0
		2.2
		2.4
		2.7
		3.0

E 6	E 12	E 24
3.3	3.3	3.3
		3.6
		3.9
4.7	4.7	4.3
		4.7
		5.1
		5.6
6.8	6.8	5.6
		6.2
		6.8
		7.5
		8.2
		9.1

E 48	E 96	E 192	E 48	E 96	E 192	E 48	E 96	E 192	E 48	E 96	E 192	E 48	E 96	E 192
100	100	100	162	162	162	261	261	261	422	422	422	681	681	681
		101			164			264			427			690
		102			165			267			432			698
105	105	105	169	169	169	274	274	274	442	442	442	715	715	715
		106			172			277			448			723
		107			174			280			453			732
110	110	110	178	178	178	287	287	287	464	464	464	750	750	750
		111			180			291			470			759
		113			182			294			475			768
115	115	115	187	187	187	301	301	301	487	487	487	787	787	787
		117			189			305			493			796
		118			191			309			499			806
121	121	121	196	196	196	316	316	316	511	511	511	825	825	825
		123			198			320			517			835
		124			200			324			523			845
127	127	127	205	205	205	332	332	332	536	536	536	866	866	866
		129			208			336			542			876
		130			210			340			549			887
133	133	133	215	215	215	348	348	348	562	562	562	909	909	909
		135			218			352			569			920
		137			221			357			576			931
140	140	140	226	226	226	365	365	365	590	590	590	953	953	953
		142			229			370			597			965
		143			232			374			604			976
147	147	147	237	237	237	383	383	383	619	619	619	988	988	988
		149			240			388			626			
		150			243			392			634			
154	154	154	249	249	249	402	402	402	649	649	649			649
		156			252			407			657			
		158			255			412			665			
		160			258			417			673			

Designation of resistance values according to IEC 62 and MIL:

resist. value	IEC 62	MIL 39008
0,1 Ohm	0R1 (R10)	-
1,0 Ohm	1R (1R0)	1R0
10 Ohm	10R	100
100 Ohm	100R (K10)	101
1000 Ohm	1 K (1K0)	102
10 KOhm	10K	103
0,1 MOhm	100K (M10)	104
1,0 MOhm	1M (1M0)	105
10,0 MOhm	10M	106

4-band colour code
colour coding of
resistance values and tolerances

5-band colour code
colour coding of
resistance values and tolerances

colour	1st band= 1st digit	2nd band= 2nd digit	3rd band= multi- plier	4th band= tole- rance
<i>without</i>	-	-	-	±20%
<i>silver</i>	-	-	x 0,01 Ω	±10%
<i>gold</i>	-	-	x 0,1 Ω	± 5%
<i>black</i>	-	0	x 1,0 Ω	-
<i>brown</i>	1	1	x 10 Ω	± 1%
<i>red</i>	2	2	x 100 Ω	± 2%
<i>orange</i>	3	3	x 1 kΩ	-
<i>yellow</i>	4	4	x 10 kΩ	-
<i>green</i>	5	5	x 100 kΩ	-
<i>blue</i>	6	6	x 1 MΩ	-
<i>violet</i>	7	7	x 1 MΩ	-
<i>grey</i>	8	8	-	-
<i>white</i>	9	9	-	-

1st band= 1st digit	2nd band= 2nd digit	3rd band= 3rd digit	4th band= multi- plier	5th band tole- rance
-	-	-	-	-
-	-	-	x 0,01 Ω	-
-	-	-	x 0,1 Ω	± 5%
-	0	0	x 1,0 Ω	-
1	1	1	x 10 Ω	± 1%
2	2	2	x 100 Ω	± 2%
3	3	3	x 1 kΩ	-
4	4	4	x 10 kΩ	-
5	5	5	x 100 kΩ	±0,5%
6	6	6	x 1 MΩ	-
7	7	7	x 1 MΩ	-
8	8	8	-	-
9	9	9	-	-

:

Tolerances according to MIL:

Tolerance	MIL
10 %	K
5 %	J
2 %	G
1 %	F
0,5 %	D
0,25 %	C
0,1 %	B

Designation and coding of temperature coeff.:

100	$\frac{10^{-6}}{K}$	T0	brown
50	"	T2	red
25	"	T9	yellow
15	"	T10	orange
10	"	T13	blue
5	"	T16	violet
2	"	T18	-

Resistors in the DC-circuit:

R = resistance value [Ω] I = current [A]
 U = voltage [V] P = power [W]

$$R = \frac{U}{I} \quad I = \frac{U}{R} \quad U = I \cdot R$$

$$P = I^2 \cdot R \quad P = \frac{U^2}{R} \quad P = U \cdot I$$

Resistors in series

$$R_{ges.} = R_1 + R_2 + \dots + R_n$$

Resistors in parallel

$$\frac{1}{R_{ges.}} = \frac{1}{R_1} + \frac{1}{R_2} + \dots + \frac{1}{R_n}$$

2 resistors in parallel

$$R_{ges.} = \frac{R_1 \cdot R_2}{R_1 + R_2}$$

Voltage divider R_1 in series with R_2

$$U_{ges.} = U_1 + U_2$$

$$\frac{U_1}{U_2} = \frac{R_1}{R_2}$$

Current splitting R_1 in parallel with R_2

$$I_{ges.} = I_1 + I_2$$

$$\frac{I_1}{I_2} = \frac{R_2}{R_1}$$

Temperature coefficient for wirewound resistors:

Series K Table 1: Temperature coefficient of resistive wires used for series KC, KH, KV, KT, KF (Power wirewound resistors of Vitrohm with high pressure crimped contact)

P ₇₀	Typ/Type	TK/TC 400 ^{±50}	TK/TC 0 ⁺⁴⁰ ₋₈₀	TK/TC 0 ^{±10}
1W	200	0R056 - 0R2	0R22 - 300R	330R - 9K1
2W	202	0R075 - 0R43	0R47 - 620R	680R - 20K
3W	204	0R33 - 0R68	0R75 - 1K	1K1 - 30K
4W	206	0R056 - 0R2	0R22 - 300R	330R - 9K1
5W	208	0R075 - 0R3	0R33 - 470R	510R - 15K
7W	210	0R11 - 0R68	0R75 - 1K	1K1 - 30K
	212	0R075 - 0R3	0R33 - 470R	510R - 15K
9W	214	0R11 - 0R68	0R75 - 1K	1K1 - 30K
11W	216	0R15 - 1R	1R1 - 1K3	1K5 - 47K
17W	218	0R27 - 1R6	1R8 - 2K4	2K7 - 82K

TC in ppm = 10⁻⁶ K⁻¹

Series KP Table 2: Temperature coefficient of resistive wires used for series KP

P ₇₀	Type	TC 400 ^{±50}	TC 0 ⁺⁴⁰ ₋₈₀	TC 0 ^{±20}
2 W	290	0R2 - 0R24	0R27 - 560R	620R - 7K5
4 W	292	0R3 - 0R39	0R32 - 820R	910R - 11K
5 W	294	0R47 - 0R62	0R68 - 1K3	1K5 - 20K
6,5W	296	0R68 - 0R91	1R - 1K8	2K - 27K
8 W	298	0R91 - 1R2	1R3 - 2K4	2K7 - 36K

Series BW / BWF Table 3: Temperature coefficient of resistive wires used for series BW/BWF

234-0	0R1 ... 0R15	TK ± 600	237-0	0R1	TK ± 1000
	0R16 ... 0R62	TK ± 300		0R11 ... 0R18	TK ± 600
	0R68 ... 1K2	TK ± 150		0R2 ... 0R68	TK ± 300
235-0	0R1 ... 0R16	TK ± 1000	236-0	0R75 ... 1K	TK ± 150
	0R18 ... 0R68	TK ± 800		0R1	TK ± 1800
	0R75 ... 2K4	TK ± 400		0R11 ... 0R16	TK ± 1000
				0R18 ... 0R68	TK ± 800
				0R75 ... 1K	TK ± 400

Due to mechanical contacts resistive changes of ± 1,5 % are possible. This may influence results of TC-measurments.

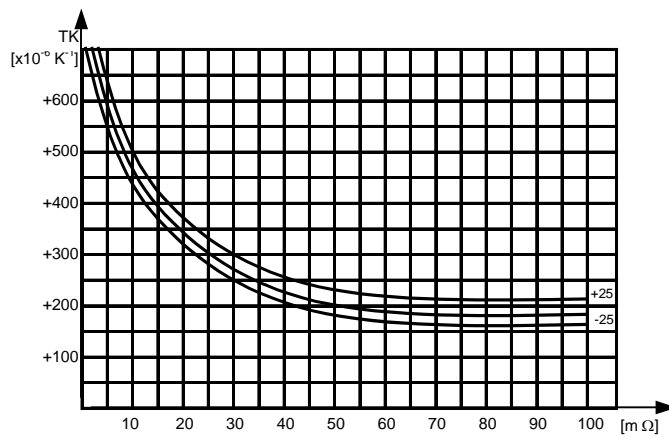

Diagram: Temperature coefficient of metal-band resistors series KN (350-354)

Pulse capability of resistors:

General information on pulse capability very often need additional explanations and do not always comply with a given application.

Please contact factory or sales office for your special requirements. For dealing with your application we need the following information:

- Pulse shape and repetition rate
- max. peak power
- Pulse duration or time constant
- max. peak voltage
- Resistance value

If already selected:

- Type or series or technology
- or preferred style

The Quality Assurance System of Vitrohm Group meets all requirements of CECC 00114 part 1, Harmonized System of Quality Assessment for Electronic Components (System of Quality Assessment for General Requirements) and meets also the requirements of DIN-ISO 9001:2000.

By this statement the General Management obliges all employees to fulfil their duties in accordance with the Quality Handbook, to assure the quality of all Vitrohm Products to meet the requirements of CECC and other standards.

All technical data given in this catalogue are based on statistical methods using equipments of modern techniques. The data are based on mass production. Therefore, testresults of singular specimens might differ from the average range of series.

All details in printed form are legally binding only after written confirmation conforming to §§ 463 and 480 II BGB.

We reserve the right to change products and specifications due to technical development.



Taping Specification
for axial components

Series	Type	Style	L _{max}	e	Taping		Pieces Reel	E	Pieces Ammo
					s	g			
KC	200-0	0416	18,0	6	5	95	2000	356	1000*
	202-0	0424	26,0	6	5	95	2000	356	1000*
	204-0	0432	33,0	6	5	95	2000	356	1000*
KH	206-8	7x7x20	21,0	6	10	95	1000	356	-----
	208-8	7x7x25	26,0	6	10	95	1000	356	-----
	210-8	7x7x38	39,0	6	10	95	1000	356	-----
	212-8	10x10x26	26,0	6	10	95	500	356	-----
	214-8	10x10x38	39,0	6	10	95	500	356	-----
BW / F	234-0	0411	10,1	6	5	85	4000	356	1000*
	235-0	0614	14,5	6	10	85	1000	356	1000*
	236-0	0614	14,5	6	10	85	1000	356	1000*
	237-0	0411	10,1	6	5	85	4000	356	1000*
BWL	BWL 0614	0614	14,5	6	10	85	1000	356	1000*
CR / F	251-0/4	0309	9,5	6	5	65	5000	356	1000*
	253-0/4	0414	14,5	6	10	85	2000	356	1000*
	254-0/4	0612	13,5	6	10	85	1000	356	1000*
	255-0	0915	15,0	6	10	85	1000	356	500*
	256-0/4	0617	18,0	6	10	85	1000	356	1000*
	257-0/4	0918	19,0	6	10	85	1000	356	500*
	258-0	0922	23,0	6	10	85	1000	356	500*
	259-0	0927	27,0	6	10	85	1000	356	500*
KN	350-8	7x7x18	19,0	6	10	85	1000	356	-----
RG	515-0	0207	6,6	6	5	65	5000	356	1000*
	520-0	0309	8,2	6	5	65	5000	356	1000*
PO	590-0	0617	16,5	9	10	95	1000	270	1000*
	591-0	0922	20,0	9	10	95	500	270	500*
	593-0	0414	12,0	6	5	85	2500	270	1000*
	595-0	0207	6,3	6	5	65	5000	315	2000*
RX	0207 W5	0207	6,2	6	5	65	-----	-----	5000*
	0410 1W	0410	10,0	6	5	65	-----	-----	2000*
	0515 1W	0515	15,0	6	5	65	-----	-----	1000*
	0512 3W	0512	12,0	6	5	65	-----	-----	1000*
	0613 3W	0613	13,0	6	10	65	-----	-----	1000*
	0516 3W	0516	15,5	6	10	65	-----	-----	1000*
	0616 3W5	0616	16,0	6	10	65	-----	-----	1000*
	0716 3W	0716	16,0	6	10	65	-----	-----	500*
0716 4W	0716	16,0	6	10	65	-----	-----	500*	
ZOM	ZOM0207	0207	6,6	6	5	65	5000	356	2000*

*Standard

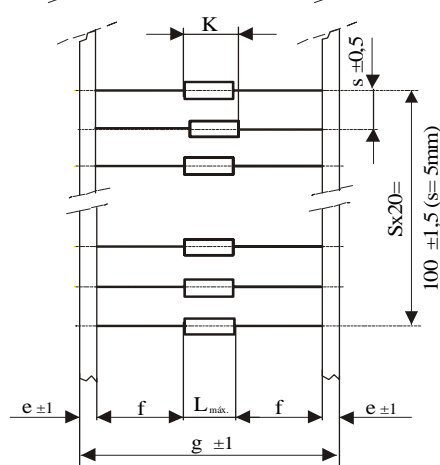
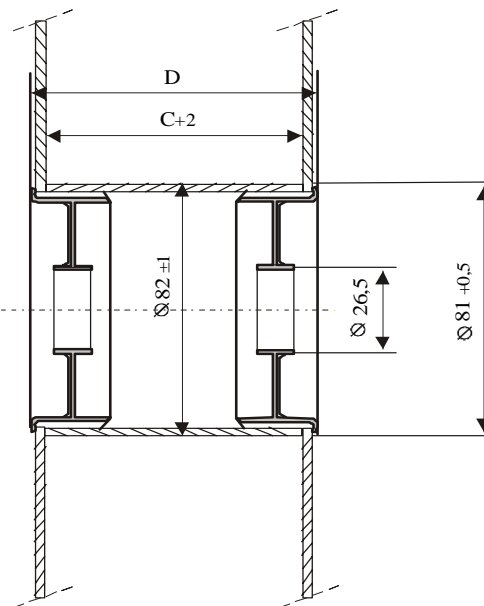
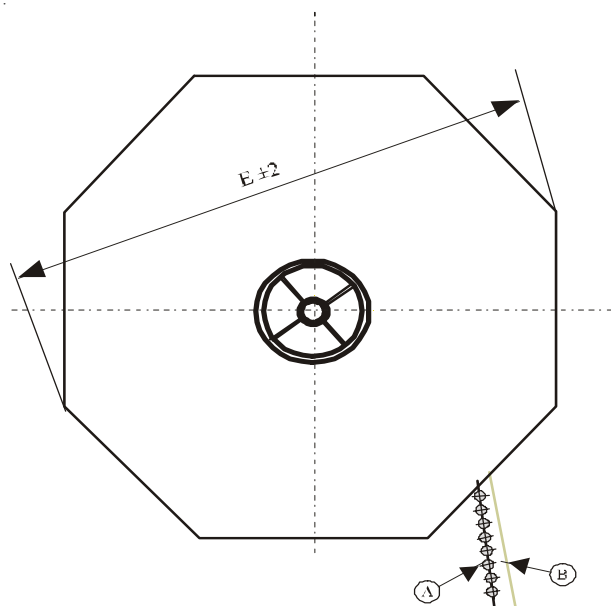

- A taped resistors
- B intermediate paper
- C inner reel width $g+5$
- D outer reel width $g+10$
- E maximum reel diameter

$L_{máx.}$ Body length

k $L_{máx.} + 1,4$ (k concentric between the tapes)

- f ≥ 20 mm
- g taped width
- s step size
- e taped width

standard taping acc. to IEC 60286-1

Insulated Wirewound Resistors, moulded



Specifications

Type		BW234-0	BW235-0
Style		0411	0614
Power rating P_{70}	W	0,75 ($P_{50} = 1,0$)	1,5 ($P_{25} = 2,0$)
Resistance range	Ω	0R1 ... 1K2	0R1 ... 2K4
E-Series		E 24, E 12	
Tolerances	%	$\pm 5, \pm 10$	
Temperature coefficient	$10^{-6} \cdot K^{-1}$	see table next page	
max. cont. work. voltage	V_{RMS}	$\sqrt{P_{70} \cdot R}$	
Insulation voltage (1min.)	V_{RMS}	700	1000
Insulation resistance	Ω	$> 10^4 M$	
Derating linear	$^{\circ}C$	70 ... 175 (0W)	
Climatic category		55/175/56	
Temperature range	$^{\circ}C$	- 55 ... 175	
Thermal resistance	KW^{-1}	140	80
Failure rate (Total, ϑ_0 max., 60% conf. lev.)		appr. 100, depends on value	
Endurance (P_{70} , 1000h)	$\left[\frac{AR}{R}\right] \%$	$\pm 5,0$ average	
Damp heat, steady state (40 $^{\circ}C$, 93% r.h., 56d)	$\left[\frac{AR}{R}\right] \%$	$\pm 2,0$	
Climatic sequence	$\left[\frac{AR}{R}\right] \%$	$\pm 2,0$	
Terminal strength	$\left[\frac{AR}{R}\right] \%$	± 1	
Terminal tensile strength	N	40	
Resistance to soldering heat (260 $^{\circ}C$, 10s)	$\left[\frac{AR}{R}\right] \%$	$\pm 0,2$ typ.	
Solderability	s	2,5 Flowtime, solderglobule test, IEC 60068-2-20-T	
Marking		DIN-IEC-colour code, 4 bands	



Dimensions in mm:

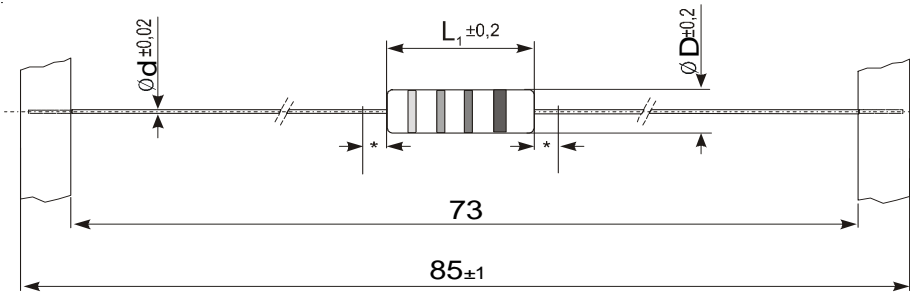

* 3mm, reduced solderability in this area.

Temperature coefficient

Typ	resistance Value	TC * 10 ⁻⁶ K ⁻¹
BW234-0	0R1 ... 0R15	± 600
	0R16 ... 0R62	± 300
	0R68 ... 1K2	± 150
BW235-0	0R1 ... 0R16	± 1000
	0R18 ... 0R68	± 800
	0R75 ... 2K4	± 400

Type	L ± 0,2	ØD ± 0,2	Ød ± 0,02	Tape step
BW234-0	9,9	3,6	0,8	5
BW235-0	14,3	5,7	1,0*	10

*Special lead diameter 0,8 mm available, type BW 235-006

Packaging:

Type	Packaging	Pieces	Pack.Code
BW234-0	taped/Ammopack	1000	T
BW235-0	taped/Ammopack	1000	T

Ordering example: BW 234-0 5 T 1K
 Type Tolerance Pack.-Code R-Value

X-ON Electronics

Largest Supplier of Electrical and Electronic Components

Click to view similar products for [Wirewound Resistors - Through Hole category](#):

Click to view products by [Vishay](#) manufacturer:

Other Similar products are found below :

[75822-2K4](#) [90J56R](#) [AC03000001208JAC00](#) [EP3WS47RJ](#) [C1010KJL](#) [C1015RJL](#) [C3A10KJT](#) [27J1K0](#) [ES3W47RJ](#) [AC04000001500JAC00](#)
[AC10000002208JAB00](#) [AC10000004708JAB00](#) [SQMW5R39J](#) [SQPW5R22J](#) [SQPW5R33J](#) [1879927-3](#) [FCB2100RJ](#) [T505](#) [FSQ5WR47J](#)
[FW10A33R0JA](#) [CPCC03R5000JB31](#) [CPCC0510R00JE32](#) [CPCC051R000JB31](#) [CPCP10500R0JE32](#) [CPW05700R0JE143](#)
[CPW152K500JE313](#) [C1010RJL](#) [C10220RJL](#) [C10R47JL](#) [C141K0JL](#) [C144R7JL](#) [ES05W100RJ](#) [SQMW1047RJ](#) [SQMW210RJ](#)
[CPCC03R2000JB31](#) [CPCC0515R00JE01](#) [CPW055R000JB143](#) [CPW103K300JE143](#) [CPW202R000JB14](#) [ULW5-39R0JT075](#) [W31-R47JA1](#)
[ULW5-68RJT075](#) [SQBW401K0JFASTON](#) [SPH1001JLF](#) [65888-3R3](#) [CPCC10R5100JE66](#) [SQP500JB-400R](#) [SQBW403R3JFASTON](#) [280-PRM7-4.7-RC](#) [CW02B9R100JE73](#)