

ZCM Series Datasheet

SMD Precision Metal Film Resistors | MELF Style

ORDERING CODE-Example

New SAP Part Nr.:

ZCM	207	F	K	E	07-	1K	AA
Serie	Power rating 204 = 0,4W 207 = 1,0W	Tol. B = ±0,1% C = ±0,25% D = ±0,5% F = ±1% G = ±2% J = ±5%	Pack-Code K = Blister tape reel	TCR C = ±15ppm D = ±25ppm E = ±50ppm F = ±100ppm	Forming type 07- = 07 inch (Reel diameter) or 13- = 13 inch (Reel diameter)	R Value	Special AA = Standard

Historical VTM Part Nr.:

ZC	0207	F	K	E	07	1K
Type	Size	Tol.	K = Blister tape reel	TC	Reel diam.	R Value

APPLICATIONS

- Automotive
- Charger
- Alternative Energy
- Power Supply
- Home Appliances
- Industrial

FEATURES

- Precision MELF resistor
- Advanced MELF technology
- Best in class pulse load capability
- Biased (85/85) test (±0,25% R) up to 1M0
- AEC – Q200 Qualified
- Intrinsic sulfur resistance
- RoHs & REACH Compliant

ELECTRICAL SPECIFICATIONS

Type		ZCM204	ZCM207
Historical Part Number	SMD	ZC0204	ZC0207
Nominal Power Rating P_{70}	[W]	0,4	1,0
Resistance Range	[Ω]	OR22 ... 10M	OR16 ... 10M
E-Series		(Other values upon request) E24 / E96 / E192	
Tolerances	±[%]	B = 0,1% , C = 0,25% , D = 0,5% , F = 1% , G = 2% , J = 5%	
Temperature Coefficient <i>IEC60115-1 clause 4.2 ; 4.8</i> <i>(+20 / -55[°C] and (+20 / +125[°C])</i>	±[10 ⁻⁶ * K ⁻¹]	Depends on the value, please check the table below	
Working Temperature Range	[°C]	-55 ... +155	
Permissible film temperature <i>(9F max.)</i>	[°C]	155	
Max. Working Voltage	[AC or DC] _{RMS}	200	350
Dielectric Withstanding Voltage <i>IEC115-1 clause 4.7 (1[min])</i>	[V] _{RMS}	300	500

DIMENSIONS [mm]

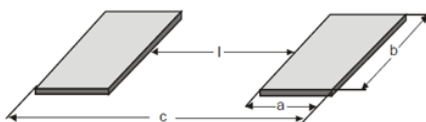
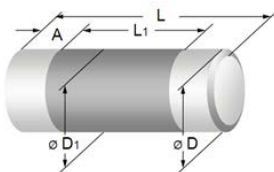

Type	Historical P/N:	L	∅ D	L ₁	∅ D ₁	A	MASS (mg)
ZCM204	ZC0204	3,6 +0/-0,2	1,4 +0/-0,1	1,8 min.	D +0/-0,15	0,80 ±0,10	22
ZCM207	ZC0207	5,8 +0/-0,3	2,2 ±0,2	2,6 min.	D +0/-0,2	1,25 ±0,2	77

Recommended solder pads dimensions

Type	Wave soldering				Reflow soldering			
	l	a	b	c	l	a	b	c
ZCM204	1,5	1,5	1,8	4,5	1,7	1,2	1,6	4,1
ZCM207	2,4	2,3	2,6	7,0	2,6	2,0	2,4	6,6

ZCM Series Datasheet

PERFORMANCE DATE

Type		ZCM204	ZCM207
Historical Part Number		ZC0204	ZC0207
Climatic Category		55/155/56	
Short Time Overload <i>IEC60115-1 clause 4.13</i> $(U=2,5 \cdot \sqrt{P_{70} \cdot R} \text{ or } \leq 2 \cdot U_{max}, 5 [s])$	±[%]	0,03 (≤1M) ; 0,1 (>1M)	0,03 (≤1M) ; 0,15 (>1M)
Single pulse high voltage overload <i>IEC60115-1 clause 4.27</i> $U = 10 \cdot \sqrt{P_{70} \cdot R}$, Severity 4, 10 pulses 10[μs]/700[μs]	±[%]	0,15	0,25
Periodic electric overload <i>IEC60115-1 clause 4.39</i> $U = \sqrt{15 \cdot P_{70} \cdot R}$, 0,1[s] on, 2,5 [s] off, 1000 cycles	±[%]	0,15	0,15
Failure Rate (Total, 90, max, 60[%] cont. lev.)	[10 ⁻⁹ h ⁻¹]	≤ 0,1	
Endurance at 70°C, standard operation <i>IEC60115-1 clause 4.25.1</i> $(P_{70} @ 70[°C], 1,5[h]ON ; 0,5[h]OFF)$	±[%]	1000h	0,15 (<10R) ; 0,1 (10R≤1M) ; 0,25 (>1M)
		8000h	0,3 (<10R) ; 0,2 (10R≤1M) ; 0,5 (>1M)
Damp Heat, Steady State <i>IEC60115-1 clause 4.24</i> (40[°C], 93[% r.h.], 56[d])	±[%]	0,15 (≤ 1M) ; 0,25 (>1M)	0,25 (≤ 1M) ; 1 (>1M)
Biased Humidity <i>IEC60068-2-67</i> $(85^{±2}[°C], 85^{±5}[% RH], U = \sqrt{0,3 \cdot P_{70} \cdot R})$	±[%]	0,25 (≤ 1M) ; 2 (>1M)	0,5 (≤ 1M) ; 2 (>1M)
Temperature Cycling <i>IEC60068-2-14 ; IEC60115-1 clause 4.19</i> (-55 ~ +125[°C], 30[min] each, 1000 cycles)	±[%]	0,15 (≤ 1M) ; 0,25 (>1M)	0,25
Vibration <i>IEC60068-2-6 ; IEC60115-1 clause 4.22</i> (10;2000[Hz], ≤1,5[mm], or ≤200[m/s ²] 7,5[h])	±[%]	0,05 (≤ 1M) ; 0,1 (>1M)	0,05
Resistance to Soldering Heat <i>IEC60115-1 clause 4.18</i> (260 ^{±5} [°C], 10 ^{±1} [s]) Solder bath method	±[%]	0,1 (≤ 1M) ; 0,05 (>1M)	0,1 (≤ 1M) ; 0,05 (>1M)
Electrostatic Discharge <i>IEC60115-1 clause 4.38 ; IEC61340-3-1</i> (3 positives + 3 negatives discharges)	±[%]	0,5 [2 kV]	0,5 [4 kV]
Voltage proof <i>IEC60115-1 clause 4.7</i> $U_{RMS}=U_{INS}, 60 [s]$		No flash over or breakdown	
Flammability <i>IEC60115-1 clause 4.35, IEC60695-11-5</i> Needle flame test, 10[s]		No burning after 30[s]	
Solderability <i>IEC60068-2-20 ; IEC60115-1 clause 4.17</i> (235 ^{±3} [°C] 2 ^{±0,2} [s], SnAg ₃ Cu _{0,3})		≥ 95% covered, no visible damage	
Component Resistance to Solvents <i>IEC60068-2-45 ; IEC60115-1 clause 4.29</i> (50[°C] method 2)		No visible damage	
Resistance to solvents of Marking <i>IEC60068-2-45 ; IEC60115-1 clause 4.30</i> (50[°C] method 1)		Marking visible, no visible damage	
Marking <i>IEC60062</i>		Color code	

NOTES: MARKING [COLOR CODE]:

- **ZCM204** Color code marking is applied according to IEC 60062 in four bands (E24 series) for 5 % tolerance, or in five bands (E96 or E192 series). Each color band appears as a single solid line, voids are permissible if at least 2/3 of the band is visible from each radial angle of view. The last color band for tolerance is approximately 50 % wider than the other bands.
- **ZCM207** Color code marking is applied according to IEC 60062 in four (E24 series) or six bands (E96 series). Each color band appears as a single solid line, voids are permissible if at least 2/3 of the band is visible from each radial angle of view. The last color band represents the TCR for resistors with TCR ≤50 ppm/K and nominal tolerance ≤1 %. Zero ohm jumpers are marked with one centered black band.

ZCM Series Datasheet

TEMPERATURE COEFFICIENT

ZCM204		ZCM207		Tolerance	TCR	E-Series
Resistance range		Resistance range				
0R22 ... 0R91	0R16 ... 0R91	0R22 ... 0R91	0R16 ... 0R91	± 5%	± 100 ppm/K	E24
				± 2%		
0R82... 10M	1R... 10M	1R... 10M	1R... 10M	± 1%	± 50 ppm/K	E24 / E96
10R... 1M65	1R... 2M21	1R... 2M21	1R... 2M21	± 0,5%		
10R... 1M65	43R... 1M	43R... 1M	43R... 1M	± 0,5%	± 25 ppm/K	E24 / E192
22R... 1M65	43R... 1M	43R... 1M	43R... 1M	± 0,25%		
22R... 1M65	43R... 1M	43R... 1M	43R... 1M	± 0,1%	± 15 ppm/K	E24 / E192
10R... 221K	100R... 511K	100R... 511K	100R... 511K	± 0,5%		
22R... 221K	100R... 511K	100R... 511K	100R... 511K	± 0,25%		
43R... 221K	100R... 511K	100R... 511K	100R... 511K	± 0,1%		
Jumper $I_{max} = 3A$	Jumper $I_{max} = 5A$	Jumper $I_{max} = 5A$	Jumper $I_{max} = 5A$	≤ 10 mΩ		

NOTES: RESISTOR BODY COLOR CODE:

- The body coating color is light green for jumpers and for a temperature coefficient of ±50 or 100 [ppm], pink for ±25[ppm] and violet for ±15[ppm]

MAXIMUM RESISTANCE CHANGE AT RATED DISSIPATION

OPERATION MODE	ZCM204			ZCM207		
	PRECISION	STANDARD	POWER	PRECISION	STANDARD	POWER
Rated Power dissipation P_{70} [W]	0,07	0,25	0,4	0,125	0,4	1,0
Operating temp. range [°C]	-10 to 85	-55 to 125	-55 to 155	-10 to 85	-55 to 125	-55 to 155
Permissible film temperature ϑF_{Max} [°C]	85	125	155	85	125	155
Resistance range	10R – 1M	R22 – 1M	R22 – 10M	100R – 511K	1R0 – 1M	1R0 – 1M
Max. Resistance drift [%] [ΔR/R]	1000h	≤0,05	≤0,15	≤0,25	≤0,05	≤0,15
	8000h	≤0,1	≤0,3	≤0,5	≤0,1	≤0,3
	225 000h	≤0,25	≤0,75	-	≤0,25	≤1,0

PERFORMANCE GRAPH'S

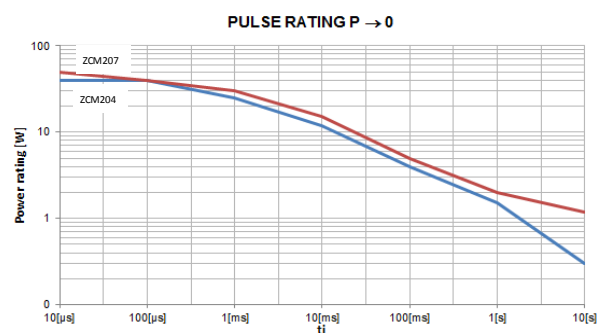
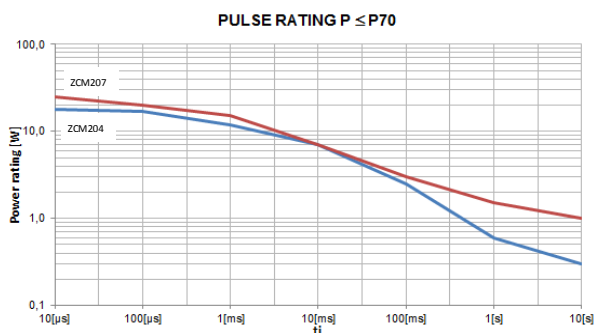
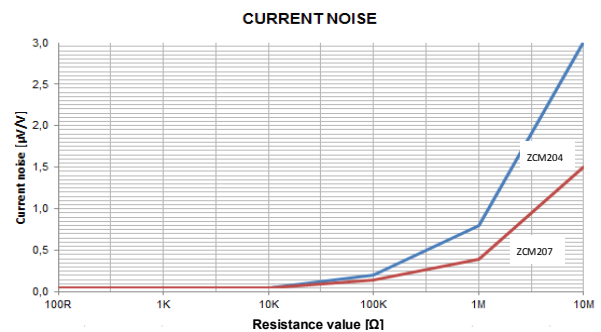
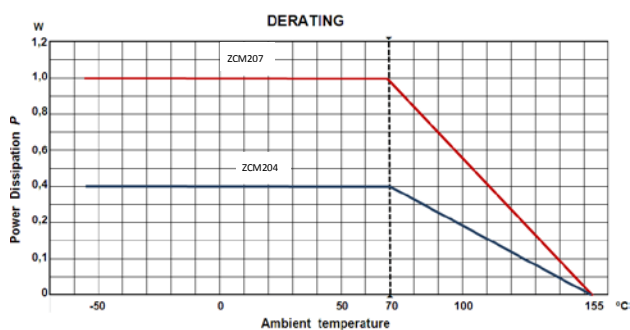

ZCM Series Datasheet

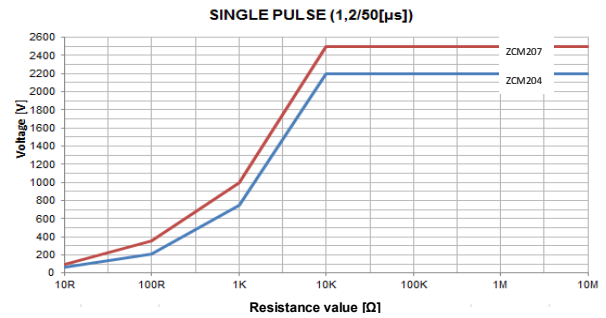
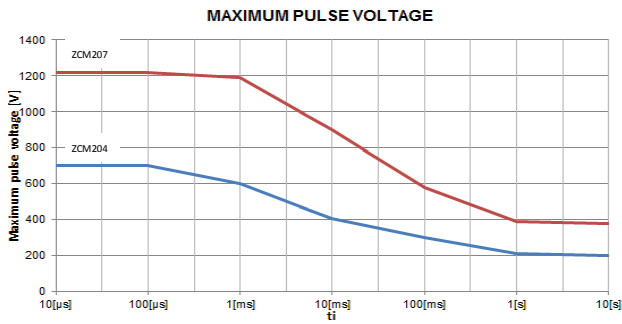

PACKAGING - Blister tape

The type ZCM is packed in antistatic blister tape according to IEC60286-3, type 2a, packing details described below,

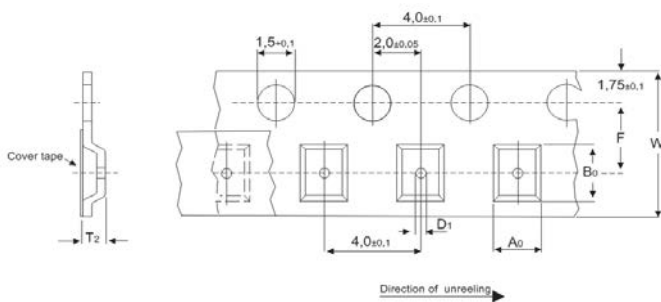
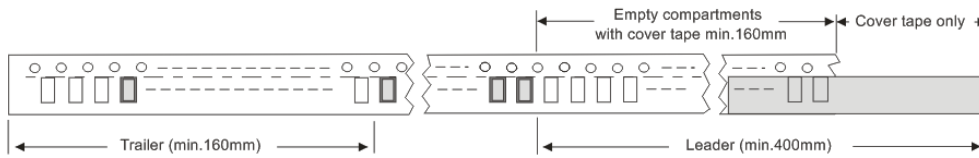

Type	A ₀	B ₀	F	W	D ₁	T ₂
ZCM204	1,55±0,1	3,7±0,1	3,5±0,05	8,0±0,3	1,0	≤ 1,8
ZCM207	2,40±0,1	6,0±0,1	5,5±0,05	12,0±0,3	1,5	≤ 2,7

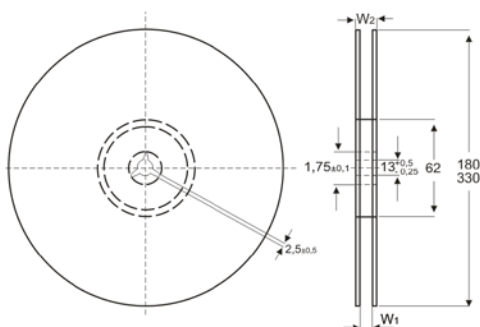

Type	W ₁ [±1,5]	W ₂ [max]
ZCM204	8,4	14,4
ZCM207	12,4	18,4

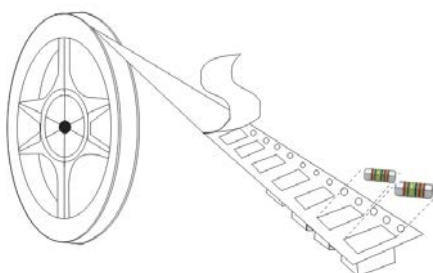

Type	Packaging [dimensions]	Quantity [pcs]
ZCM204	07(inch)	3000
ZCM207	Blister tape	1500
ZCM204	13(inch)	10000
ZCM207	Blister tape	7500

X-ON Electronics

Largest Supplier of Electrical and Electronic Components

Click to view similar products for [Multilayer Ceramic Capacitors MLCC - SMD/SMT category:](#)

Click to view products by [Vishay](#) manufacturer:

Other Similar products are found below :

[M39014/01-1467](#) [M39014/02-1218V](#) [M39014/02-1225V](#) [M39014/02-1262V](#) [M39014/02-1301](#) [M39014/22-0631](#) [1210J5000102JCT](#)
[1210J2K00102KXT](#) [1210J5000103KXT](#) [1210J5000223KXT](#) [D55342E07B379BR-TR](#) [D55342E07B523DR-T/R](#) [1812J1K00103KXT](#)
[1812J1K00473KXT](#) [1812J2K00680JCT](#) [1812J4K00102MXT](#) [1812J5000102JCT](#) [1812J5000103JCT](#) [1812J5000682JCT](#) [NIN-FB391JTRF](#)
[NIN-FC2R7JTRF](#) [NPIS27H102MTRF](#) [C1206C101J1GAC](#) [C1608C0G1E472JT000N](#) [C2012C0G2A472J](#) [2220J2K00101JCT](#)
[KHC201E225M76N0T00](#) [1812J1K00222JCT](#) [1812J2K00102KXT](#) [1812J2K00222KXT](#) [1812J2K00472KXT](#) [2-1622820-7-CUT-TAPE](#)
[2220J3K00102KXT](#) [2225J2500824KXT](#) [CCR07CG103KM](#) [CGA2B2C0G1H010C](#) [CGA2B2C0G1H040C](#) [CGA2B2C0G1H050C](#)
[CGA2B2C0G1H060D](#) [CGA2B2C0G1H070D](#) [CGA2B2C0G1H151J](#) [CGA2B2C0G1H1R5C](#) [CGA2B2C0G1H2R2C](#) [CGA2B2C0G1H3R3C](#)
[CGA2B2C0G1H680J](#) [CGA2B2C0G1H6R8D](#) [CGA2B2X8R1H221K](#) [CGA2B2X8R1H472K](#) [CGA3E1X7R1C474K](#)
[CGA3E2C0G1H561JT0Y0N](#)