

<p>General Description</p> <ul style="list-style-type: none"> • Trench Power MOSFET Technology • Low $R_{DS(ON)}$ • Optimized for High Reliable Switch Application • High Current Capability • RoHS and Halogen-Free Compliant <p>Applications</p> <ul style="list-style-type: none"> • Motor Drive • Load Switch • Battery Protection • General DC/DC Converters 	<p>Product Summary</p> <table style="width: 100%; border-collapse: collapse;"> <tr> <td style="width: 60%;">V_{DS}</td> <td style="text-align: right;">30V</td> </tr> <tr> <td>I_D (at $V_{GS}=10V$)</td> <td style="text-align: right;">183A</td> </tr> <tr> <td>$R_{DS(ON)}$ (at $V_{GS}=10V$, typ)</td> <td style="text-align: right;">2.3mΩ</td> </tr> <tr> <td>$R_{DS(ON)}$ (at $V_{GS}=4.5V$, typ)</td> <td style="text-align: right;">2.7mΩ</td> </tr> </table> <p>100% UIS Tested 100% R_G Tested</p>	V_{DS}	30V	I_D (at $V_{GS}=10V$)	183A	$R_{DS(ON)}$ (at $V_{GS}=10V$, typ)	2.3m Ω	$R_{DS(ON)}$ (at $V_{GS}=4.5V$, typ)	2.7m Ω
V_{DS}	30V								
I_D (at $V_{GS}=10V$)	183A								
$R_{DS(ON)}$ (at $V_{GS}=10V$, typ)	2.3m Ω								
$R_{DS(ON)}$ (at $V_{GS}=4.5V$, typ)	2.7m Ω								

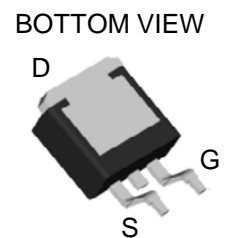
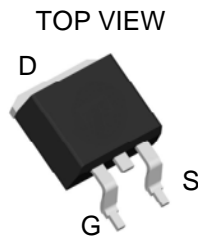
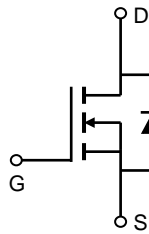

Orderable Part Number	Package Type	Form	Minimum Order Quantity
VIS30023	TO-263	Tape & Reel	3000

Absolute Maximum Ratings $T_A=25^\circ C$ unless otherwise noted

Parameter	Symbol	Maximum	Units
Drain-Source Voltage	V_{DS}	30	V
Gate-Source Voltage	V_{GS}	± 20	V
Continuous Drain Current ⁽⁵⁾	I_D	$T_C=25^\circ C$	A
		$T_C=100^\circ C$	
Pulsed Drain Current ⁽³⁾	I_{DM}	449	
Continuous Drain Current	I_{DSM}	$T_A=25^\circ C$	A
		$T_A=70^\circ C$	32
Avalanche Current ⁽³⁾	I_{AS}	65	A
Avalanche energy $L=0.1mH$ ⁽³⁾	E_{AS}	211	mJ
Power Dissipation ⁽²⁾	P_D	$T_C=25^\circ C$	W
		$T_C=100^\circ C$	
Power Dissipation ⁽¹⁾	P_{DSM}	$T_A=25^\circ C$	W
		$T_A=70^\circ C$	4.3
Junction and Storage Temperature Range	T_J, T_{STG}	-55 to 150	$^\circ C$

Thermal Characteristics

Parameter	Symbol	Typ	Max	Units
Maximum Junction-to-Ambient ⁽¹⁾ $t \leq 10s$	$R_{\theta JA}$	15.3	18.4	$^\circ C/W$
Maximum Junction-to-Ambient ^(1,4) Steady-State		67.9	81.5	$^\circ C/W$
Maximum Junction-to-Case Steady-State	$R_{\theta JC}$	0.74	0.89	$^\circ C/W$



VIS30023

30V N-Channel Power Trench MOSFET

Electrical Characteristics ($T_J=25^\circ\text{C}$ unless otherwise noted)

Symbol	Parameter	Conditions	Min	Typ	Max	Units
STATIC PARAMETERS						
BV_{DSS}	Drain-Source Breakdown Voltage	$I_D=250\text{mA}, V_{GS}=0\text{V}$	30			V
I_{DSS}	Zero Gate Voltage Drain Current	$V_{DS}=30\text{V}, V_{GS}=0\text{V}$ $T_J=55^\circ\text{C}$			1 5	μA
I_{GSS}	Gate-Body leakage current	$V_{DS}=0\text{V}, V_{GS}=\pm 20\text{V}$			± 100	nA
$V_{GS(th)}$	Gate Threshold Voltage	$V_{DS}=V_{GS}, I_D=250\text{mA}$	1.4	1.8	2.2	V
$R_{DS(on)}$	Static Drain-Source On-Resistance	$V_{GS}=10\text{V}, I_D=20\text{A}$ $T_J=125^\circ\text{C}$		2.3 2.5	2.8	m Ω
		$V_{GS}=4.5\text{V}, I_D=20\text{A}$		2.7	3.3	
g_{FS}	Forward Transconductance	$V_{DS}=5\text{V}, I_D=20\text{A}$		120		S
V_{SD}	Diode Forward Voltage	$I_S=1\text{A}, V_{GS}=0\text{V}$		0.69		V
I_S	Maximum Body-Diode Continuous Current				140	A
DYNAMIC PARAMETERS						
C_{iss}	Input Capacitance	$V_{GS}=0\text{V}, V_{DS}=15\text{V}, f=1\text{MHz}$		6335		pF
C_{oss}	Output Capacitance			756		pF
C_{rss}	Reverse Transfer Capacitance			367		pF
R_g	Gate resistance	$f=1\text{MHz}$		0.8		Ω
SWITCHING PARAMETERS						
$Q_g(10\text{V})$	Total Gate Charge	$V_{GS}=10\text{V}, V_{DS}=15\text{V}, I_D=20\text{A}$		104		nC
$Q_g(4.5\text{V})$	Total Gate Charge			51		nC
Q_{gs}	Gate Source Charge			15		nC
Q_{gd}	Gate Drain Charge			18		nC
$t_{D(on)}$	Turn-On Delay Time	$V_{GS}=10\text{V}, V_{DS}=15\text{V},$ $R_L=0.75\text{W}, R_{GEN}=3\text{W}$		8.6		ns
t_r	Turn-On Rise Time			9.6		ns
$t_{D(off)}$	Turn-Off Delay Time			58.4		ns
t_f	Turn-Off Fall Time			22.8		ns
t_{rr}	Body Diode Reverse Recovery Time	$I_F=20\text{A}, di/dt=500\text{A/ms}$		29.3		ns
Q_{rr}	Body Diode Reverse Recovery Charge	$I_F=20\text{A}, di/dt=500\text{A/ms}$		20.5		nC

- 1) $R_{\theta JA}$ is measured with the stand-alone device, without PCB, in a still air environment with $T_A=25^\circ\text{C}$. The Power dissipation P_{DSM} is based on $R_{\theta JA} \leq 10\text{s}$ and the maximum allowed junction temperature of 150°C . The value in any given application depends on the user's specific board design.
- 2) The power dissipation P_D is based on $T_{J(MAX)}=150^\circ\text{C}$, using junction-to-case thermal resistance, and is more useful in setting the upper dissipation limit for cases where additional heatsinking is used.
- 3) Single pulse width limited by junction temperature $T_{J(MAX)}=150^\circ\text{C}$.
- 4) $R_{\theta JA}$ is the sum of the thermal impedance from junction to case $R_{\theta JC}$ and case to ambient.
- 5) The maximum current rating is package limited.

TYPICAL ELECTRICAL AND THERMAL CHARACTERISTICS

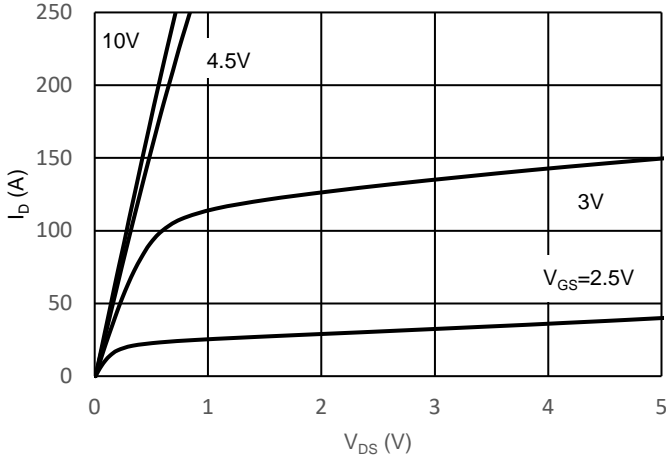

Fig 1. Typical Output Characteristics

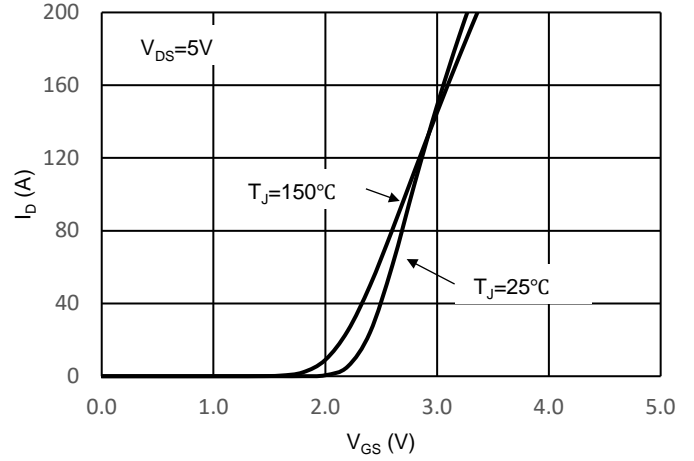

Fig 2. Typical Transfer Characteristics

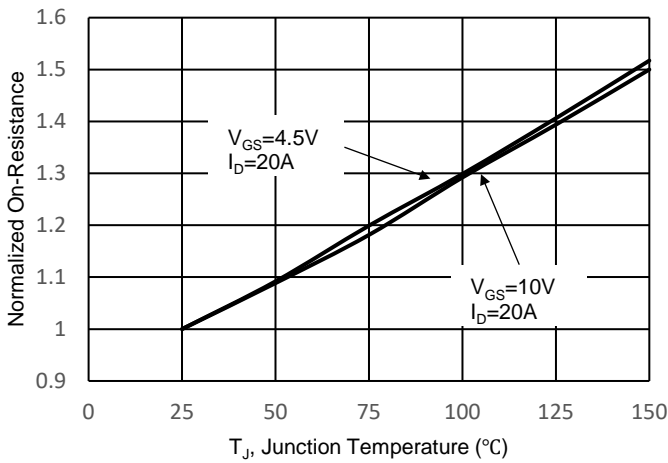

Fig 3. Normalized On-Resistance vs. Temperature

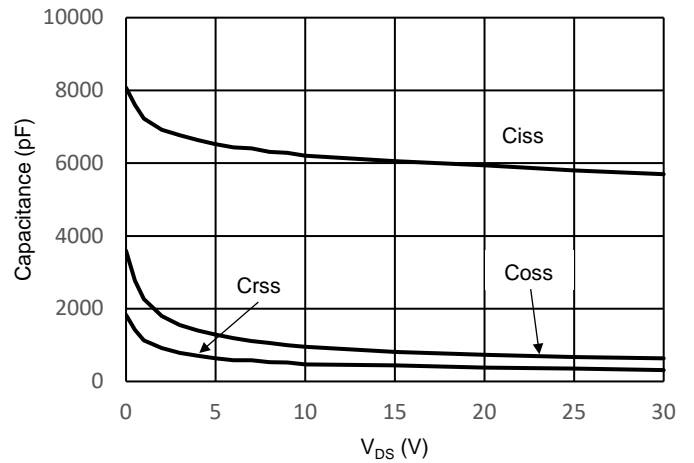

Fig 4. Typical Capacitance vs. V_{DS}

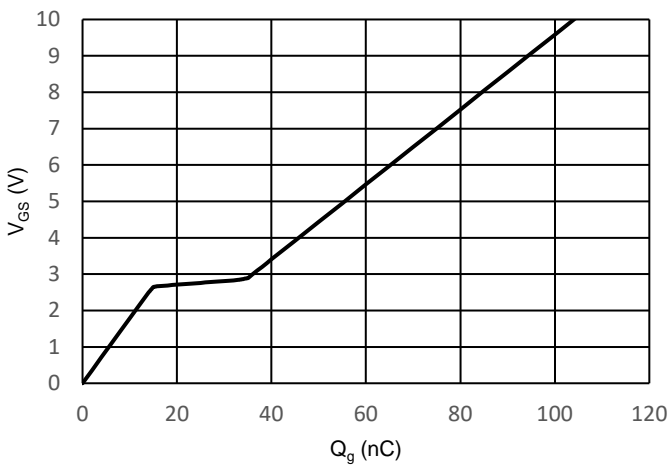

Fig 5. Typical Gate Charge vs. V_{GS}

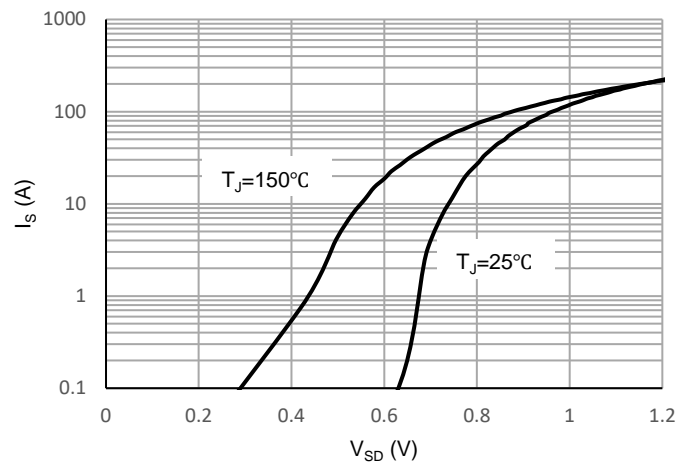

Fig 6. Typical Source-Drain Diode Forward Voltage

TYPICAL ELECTRICAL AND THERMAL CHARACTERISTICS

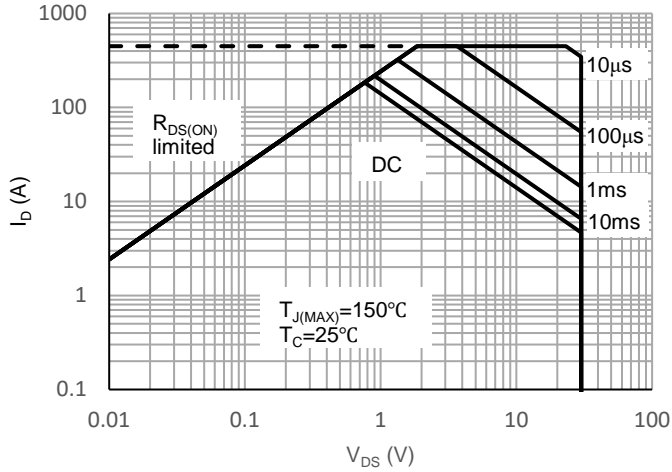

Fig 7. Maximum Safe Operating Area

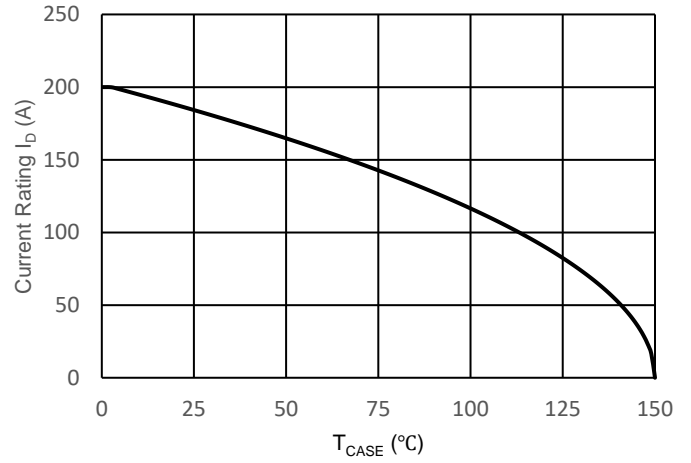

Fig 8. Maximum Drain Current vs. Case Temperature

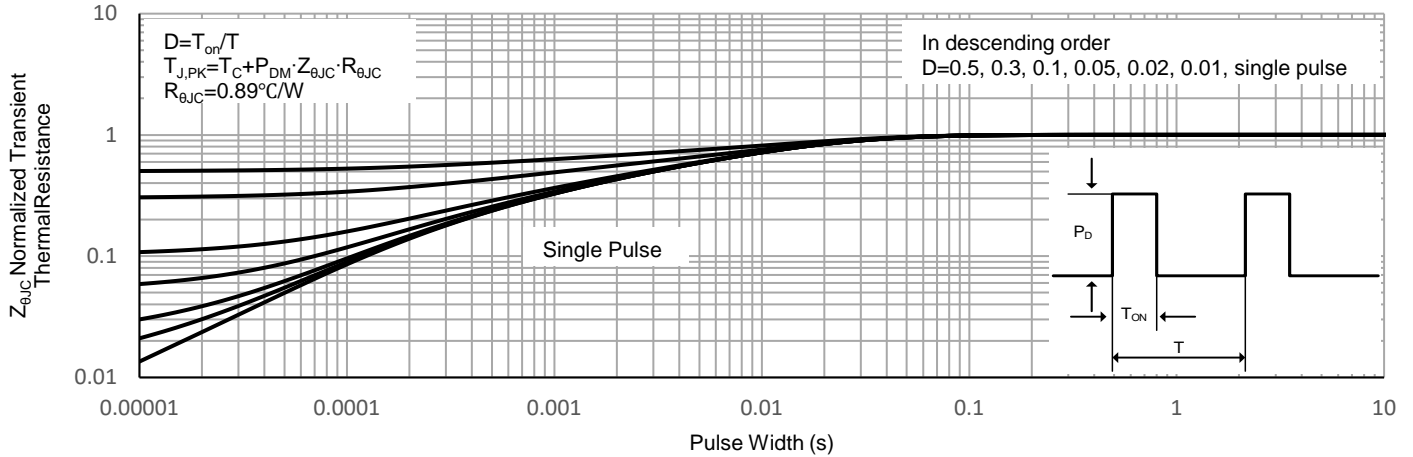

Fig 9. Normalized Maximum Transient Thermal Impedance, Junction-to-Case

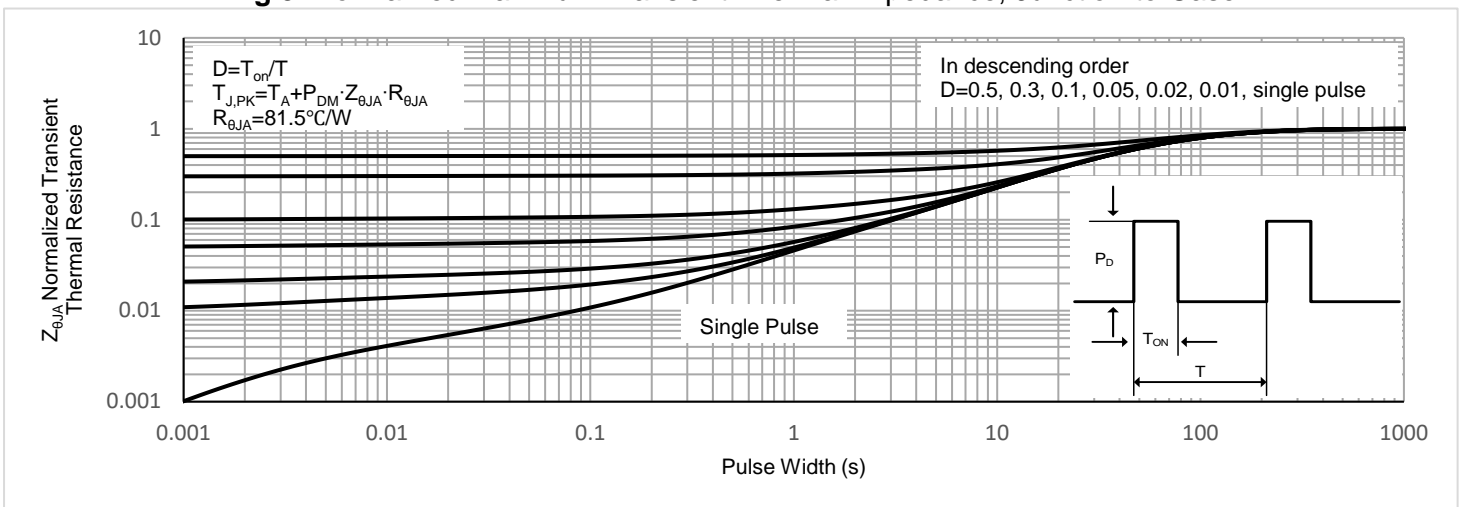

Fig 10. Normalized Maximum Transient Thermal Impedance, Junction-to-Ambient

TYPICAL ELECTRICAL AND THERMAL CHARACTERISTICS

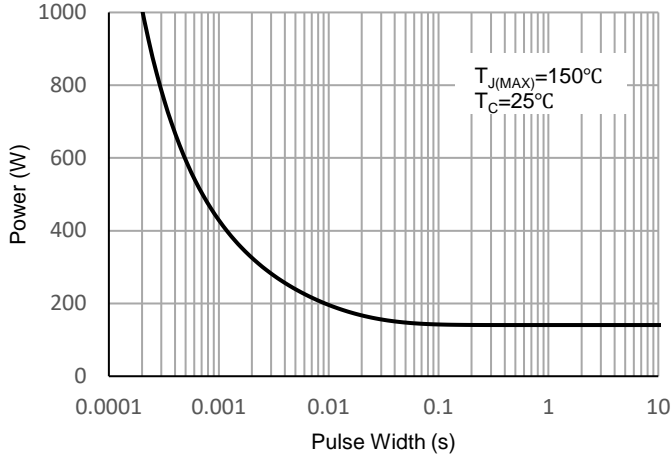

Fig 11. Single Pulse Power Rating Junction-to-Case

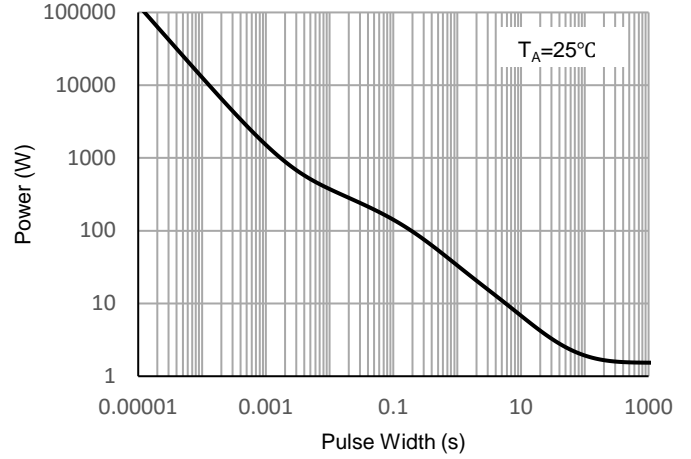

Fig 12. Single Pulse Power Rating Junction-to-Ambient

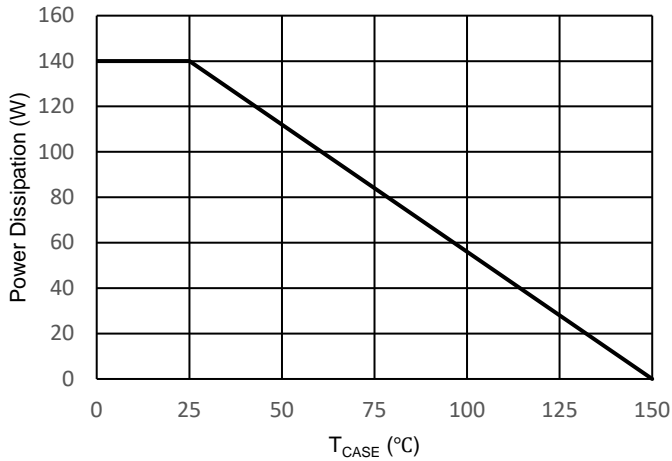

Fig 13. Maximum Power Rating vs. Temperature

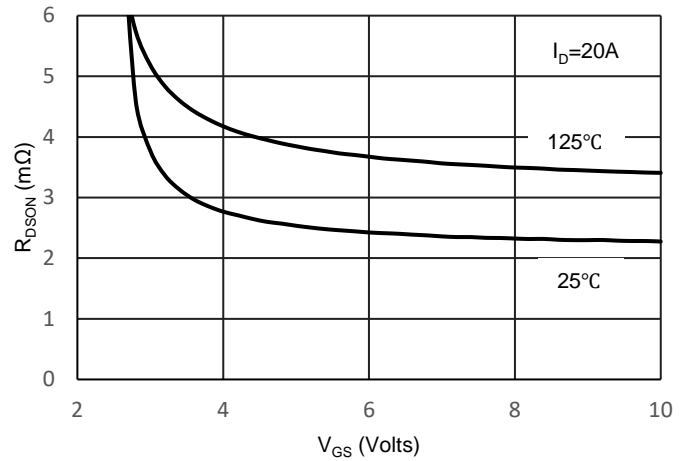

Fig 14. Maximum Power Rating vs. V_{GS}

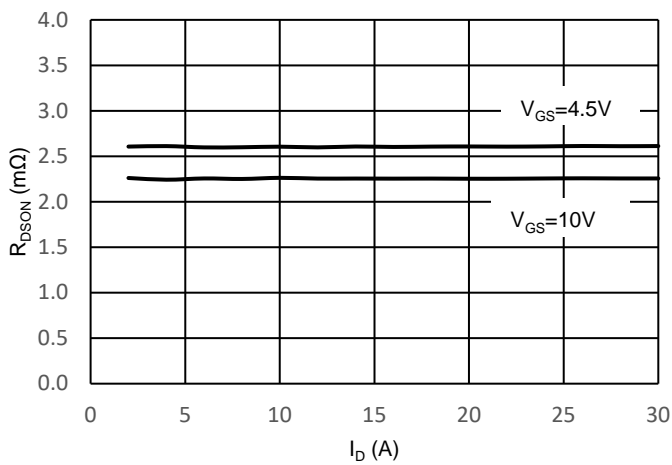

Fig 15. On-Resistance vs. Drain Current

TEST CIRCUIT

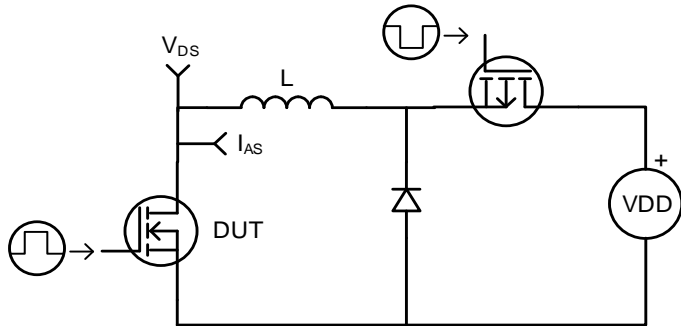

Fig16. Unclamped Inductive Test Circuit

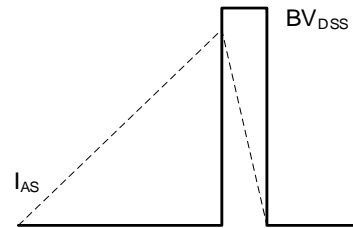

Fig17. Unclamped Inductive Waveform

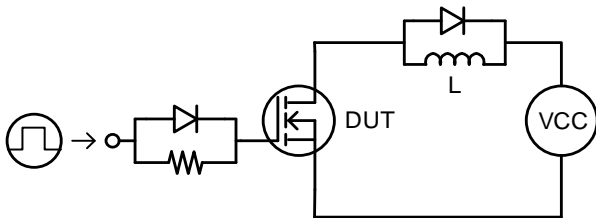

Fig18. Q_g Test Circuit

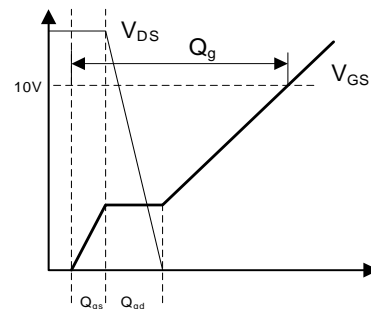

Fig19. Q_g Waveform

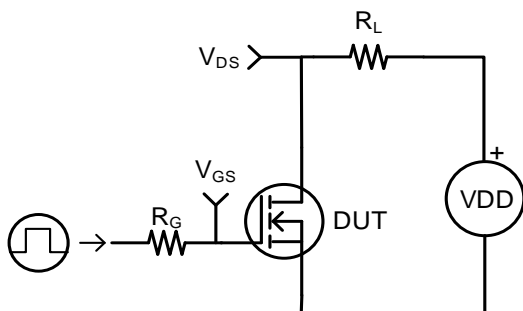

Fig18. Resistive Switching Test Circuit

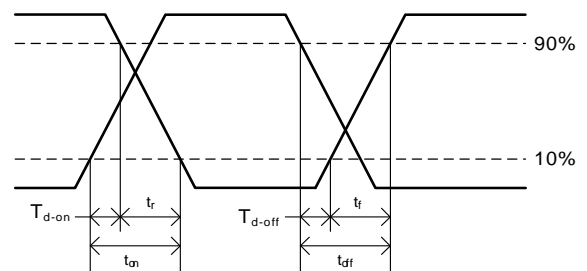

Fig19. Switching Time Waveform

TEST CIRCUIT

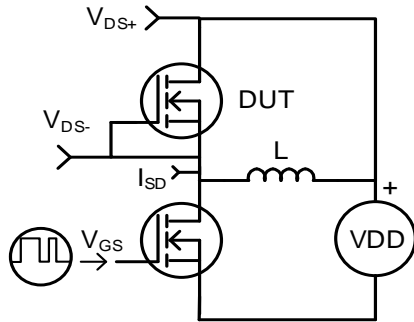

Fig20. Diode Recovery Test Circuit

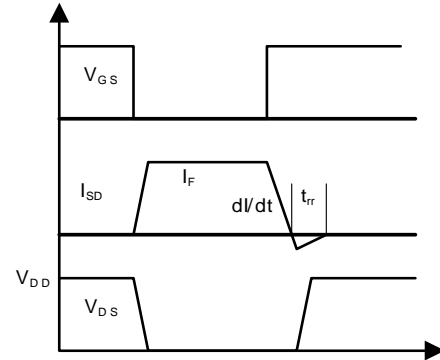
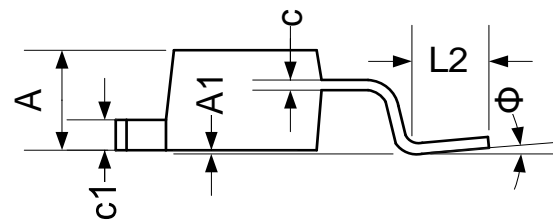
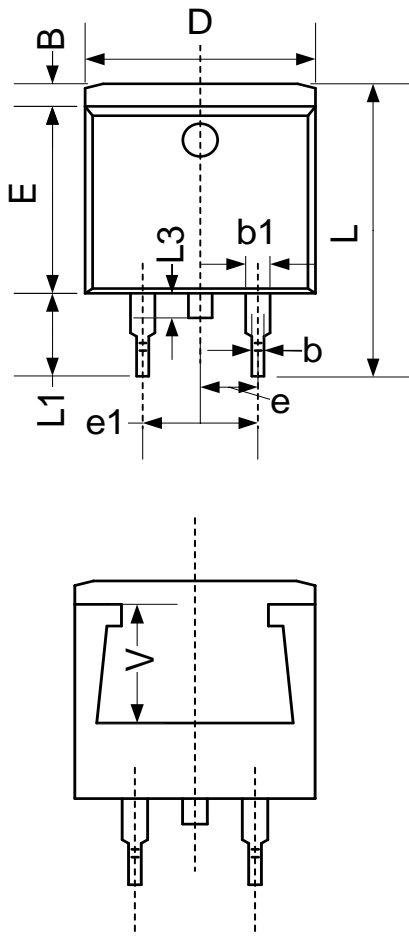

Fig21. Diode Recovery Test Waveform



SYMBOL	MILLIMETERS	
	MIN [mm]	MAX [mm]
A	4.470	4.670
A1	0.000	0.150
B	1.120	1.420
b	0.710	0.910
b1	1.170	1.370
c	0.310	0.530
c1	1.170	1.370
D	10.010	10.310
E	8.500	8.900
e	2.540 TYP.	
e1	4.980	5.180
L	14.940	15.500
L1	4.950	5.450
L2	2.340	2.740
L3	1.300	1.700
Φ	0°	8°
V	5.600 REF.	

X-ON Electronics

Largest Supplier of Electrical and Electronic Components

Click to view similar products for [MOSFET](#) category:

Click to view products by [VOLTAIC](#) manufacturer:

Other Similar products are found below :

[614233C](#) [648584F](#) [MCH3443-TL-E](#) [MCH6422-TL-E](#) [FDPF9N50NZ](#) [FW216A-TL-2W](#) [FW231A-TL-E](#) [APT5010JVR](#) [NTNS3A92PZT5G](#)
[IRF100S201](#) [JANTX2N5237](#) [2SK2464-TL-E](#) [2SK3818-DL-E](#) [FCA20N60_F109](#) [FDZ595PZ](#) [STD6600NT4G](#) [FSS804-TL-E](#) [2SJ277-DL-E](#)
[2SK1691-DL-E](#) [2SK2545\(Q,T\)](#) [D2294UK](#) [405094E](#) [423220D](#) [MCH6646-TL-E](#) [TPCC8103,L1Q\(CM](#) [367-8430-0972-503](#) [VN1206L](#)
[424134F](#) [026935X](#) [051075F](#) [SBVS138LT1G](#) [614234A](#) [715780A](#) [NTNS3166NZT5G](#) [751625C](#) [873612G](#) [IRF7380TRHR](#)
[IPS70R2K0CEAKMA1](#) [RJK60S3DPP-E0#T2](#) [RJK60S5DPK-M0#T0](#) [APT5010JVFR](#) [APT12031JFLL](#) [APT12040JVR](#) [DMN3404LQ-7](#)
[NTE6400](#) [JANTX2N6796U](#) [JANTX2N6784U](#) [JANTXV2N5416U4](#) [SQM110N05-06L-GE3](#) [SIHF35N60E-GE3](#)