

Specification	PARALLEL LINKS	
	Negative Links	Positive Links
M4 Screws – Tighten to 0.55NM	LINK-NP4	
Friction Lock		
Protrusions specified on drawings		
Brass – Tin Plated		
	LINK-NP3	
		
	LINK-NP2	
		

LINK-NP5	
	
	
LINK-NPA-2	
	
	
LINK-NPA-3	
	
	

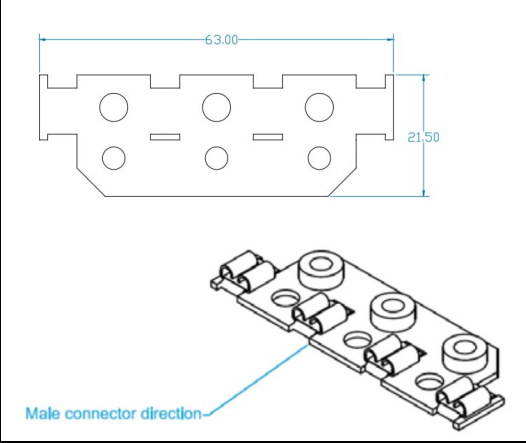
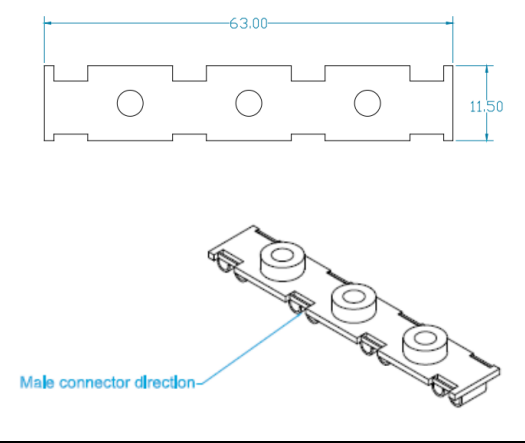
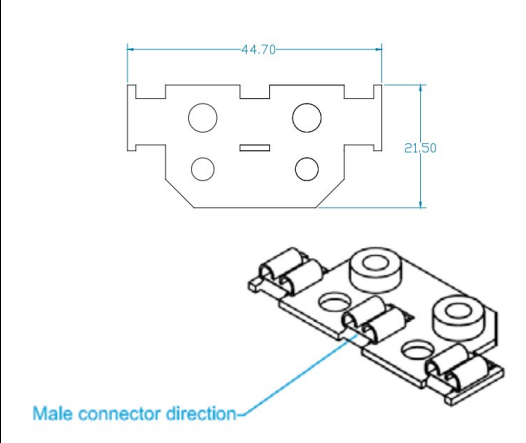
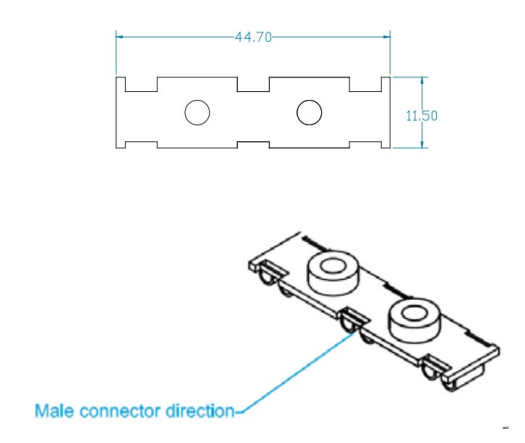
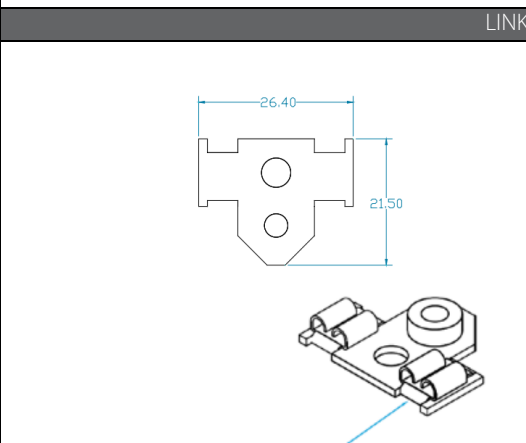
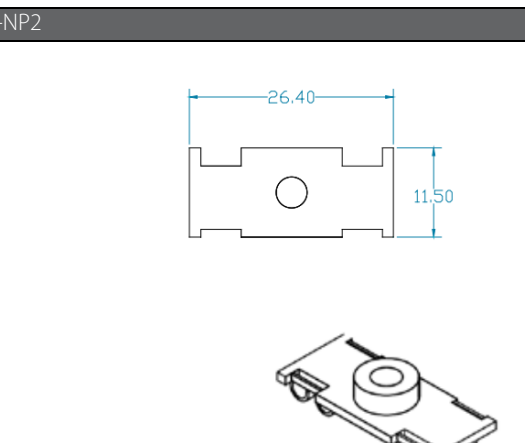
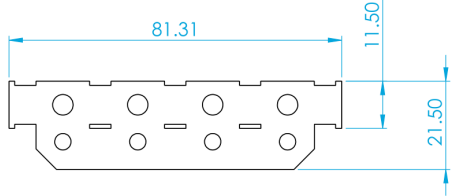
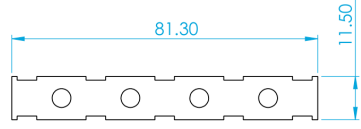
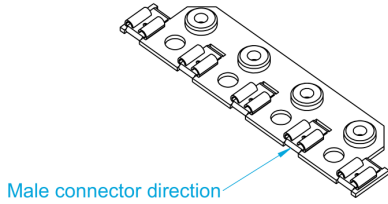
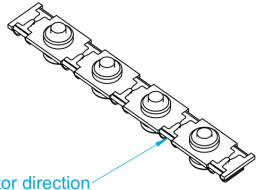
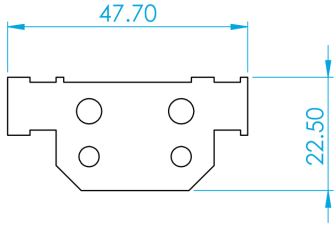
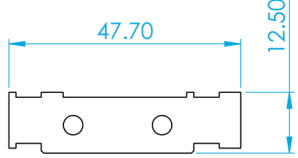
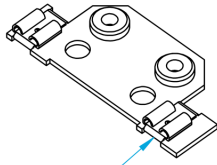
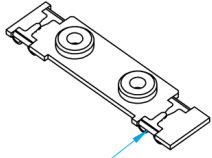
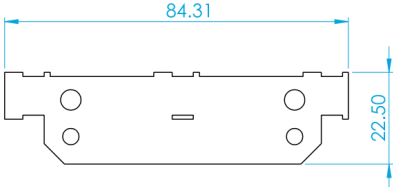
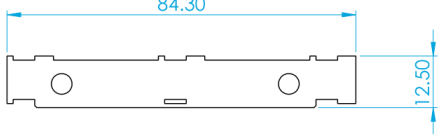
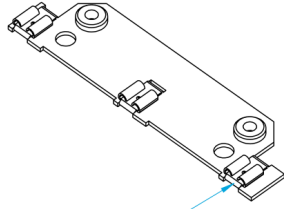
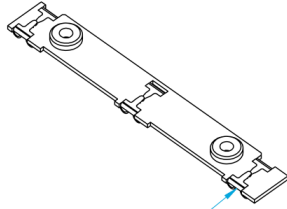
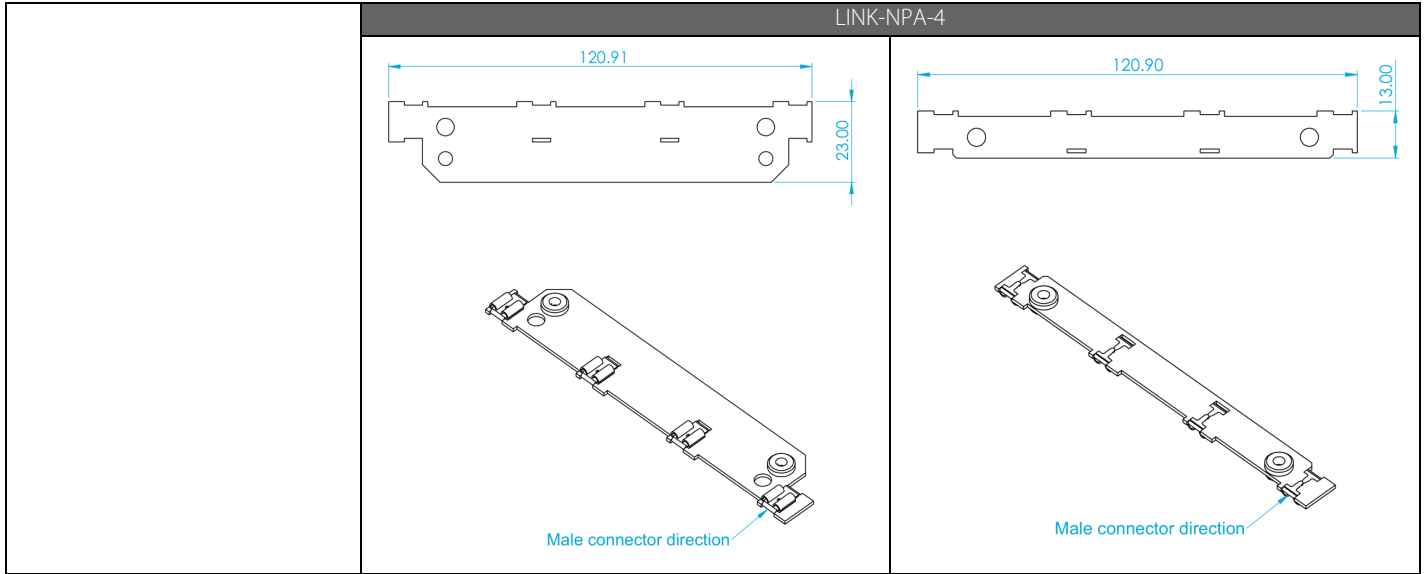
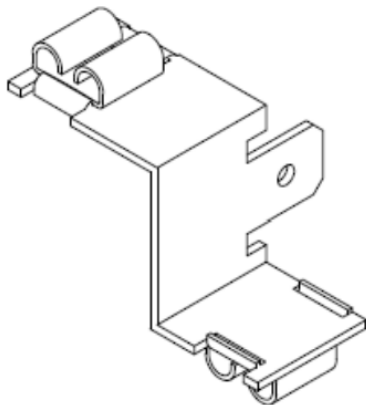
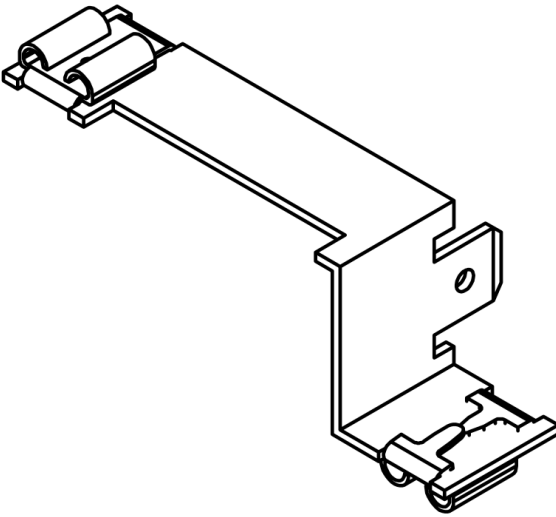
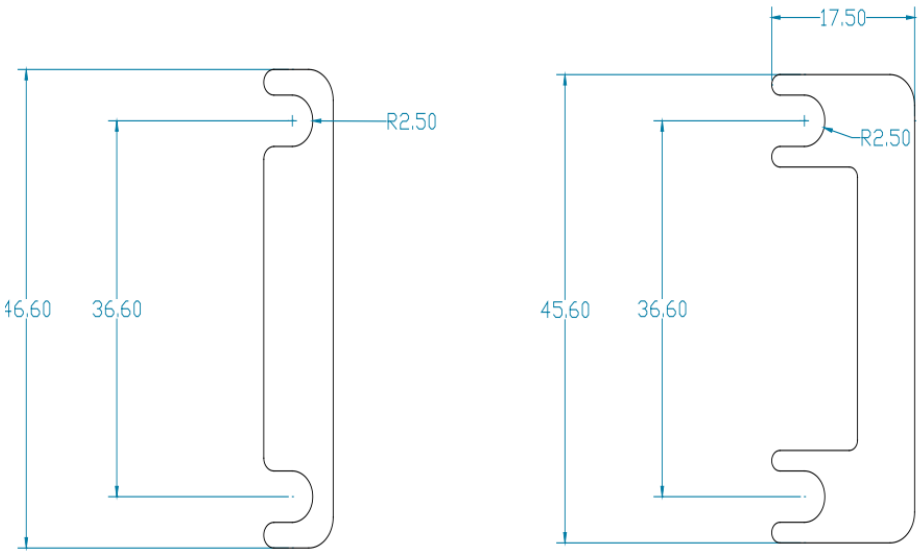

SERIES LINK	
Specification	LINK-NS
Friction Lock	
Protrude 11.50mm	
Centre Tap Point	
Specification	LINK-NSA
Friction Lock	
Protrude 11.50mm	
Off-Centre Tap Point – In-line with OP module PCB.	
Notes: Refer to the User Manual and datasheets for information on how to connect modules in parallel or in series.	

JUMPER LINK	
Specification	LINK-NJ
For linking Parallel links when connecting more than 4 modules in parallel	 <p style="text-align: center;"> <span style="margin-right: 150px;"><b>Negative Jumper</b></span> <span><b>Positive Jumper</b></span> </p>
Notes: Refer to the User Manual and datasheets for information on how to connect modules in parallel or in series.	

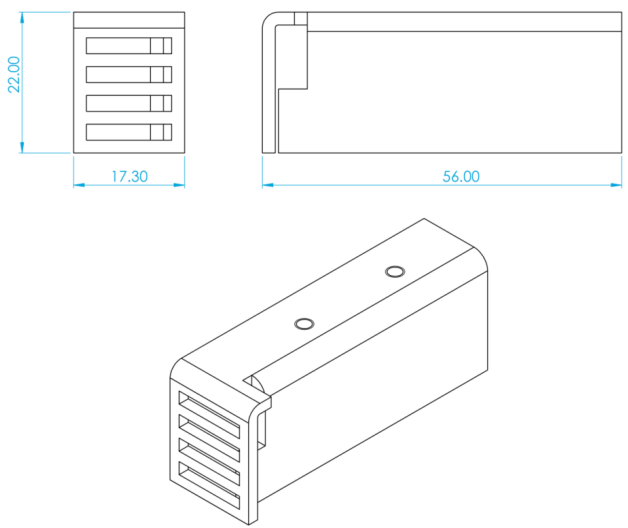
BLANKING PLATE	
Specification	OPO
Fit to inside of lid of unit when configuring.	
Zero Protrusion from unit	

Specification		SCREWS	ACC-SC-02
M3			
Length: 5mm			
Amount: 100 Screws			

All specifications are believed to be correct at time of publishing. Vox Power Ltd reserves the right to make changes to any of its products and to change or improve any part of the specification, electrical or mechanical design or manufacturing process without notice. Vox Power Ltd does not assume any liability arising out of the use or application of any of its products and of any information to the maximum extent permitted by law. No license, express or implied, by estoppel or otherwise, to any intellectual property rights is granted by this document or by any products of Vox Power Ltd. VOX POWER LTD DISCLAIMS ALL WARRANTIES AND REPRESENTATIONS OF ANY KIND WHETHER EXPRESS OR IMPLIED, INCLUDING, BUT NOT LIMITED TO, IMPLIED WARRANTIES OF SUITABILITY, FITNESS FOR PURPOSE, MERCHANTABILITY AND NON-INFRINGEMENT.

Please consult your local distributor or Vox Power directly to ensure that you have the latest revision before using the product and refer to the latest relevant user manual for further information relating to the use of the product. Vox Power Ltd products are not intended for use in connection with life support systems, human implantations, nuclear facilities or systems, aircraft, spacecraft, military or naval missile, ground support or control equipment used for the purpose of guidance navigation or direction of any aircraft, spacecraft or military or naval missile or any other application where product failure could lead to loss of life or catastrophic property damage. The user will hold Vox Power Ltd harmless from any loss, cost or damage resulting from its breach of these provisions.

## X-ON Electronics

Largest Supplier of Electrical and Electronic Components

*Click to view similar products for [Switching Power Supplies](#) category:*

*Click to view products by [Vox Power](#) manufacturer:*

Other Similar products are found below :

[70841011](#) [73-551-0005](#) [73-551-0048](#) [73-558-0015I](#) [EVS57-5R3/A](#) [FAS-002](#) [AAD600S-4-OP](#) [MS924](#) [HWS50A-5/RA](#) [KD0204](#) [9021](#)  
[LDIN100150](#) [FAP-001](#) [FP80](#) [FRV7000G](#) [22929](#) [PS3E-F12F](#) [CQM1IA121](#) [LDIN5075](#) [432703037161](#) [VI-LUL-IU](#) [LPM000-BBAR-08](#)  
[LPM000-BBAR-07](#) [08-30466-1055G](#) [DMB-EWG](#) [CQM1IPS01](#) [SP-300-5](#) [MAP40-S233](#) [CQM1-IPS02](#) [73-551-0024I](#) [VI-MUL-ES](#) [22829](#)  
[08-30466-0028G](#) [96PSR-A460WOTH-2](#) [G06-Q01](#) [GHA300F-12-SNF](#) [MP650-2K2K](#) [MTA040009A](#) [FSA150024A](#) [VI-RUR22-EWXX](#)  
[HLS30ZE-NT8](#) [UT1404-7](#) [ERP-350-12](#) [S8FSG01512C](#) [S8FSG03012C](#) [XPFM201A+](#) [S8FS-G15015C](#) [S8FS-G05005C](#) [S8FS-G03015C](#) [08-](#)  
[30466-020WG](#)