

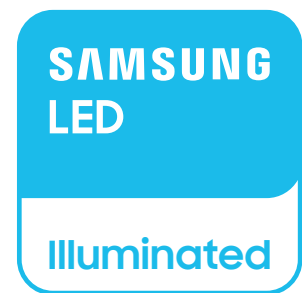

LED **LIGHTING** CATALOG

Q-4 2020



ONE COMPANY,
ENDLESS SOLUTIONS!

5 **YEAR**
WARRANTY

LED TUBES LED PANELS HIGHBAYS SMART LIGHTS WALL LIGHTS
MOTION SENSORS FLOODLIGHTS STREET LIGHTS LED TRACK LIGHTS
LED DOME LIGHTS LED BULBS LED DOWN LIGHTS SMART HOME EXIT LIGHTS



2009



V-TAC was founded with the vision of providing energy-efficient LED lighting solutions worldwide



2011



Began our EU expansion by opening the first V-TAC warehouse and office in Sofia, Bulgaria



2012



Manufacturing joint venture with MEKA Lighting



2013



Started building our distribution network in the UK from our office in Southall, London.



2015



Launched our in-house product testing lab in Sofia, Bulgaria.



2016



Achieved \$100M Annual Turnover- Manufacturing Joint Venture with DASHER Lighting for decorative lighting



2017



In-brand Partnership with Samsung and launched the V-TAC PRO Series

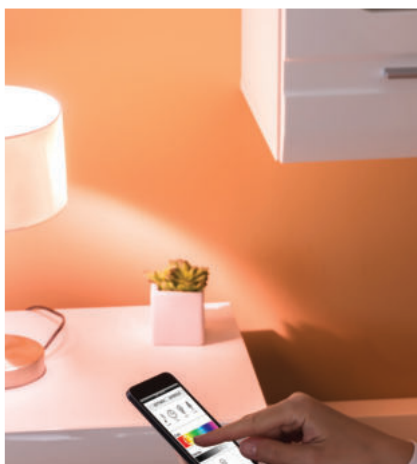

2018



• Partnership with Tuya and launched new Smart Series
• Unveiled the new V-TAC Showroom in Slough, UK



2019



Opened new 2500 meter square showroom in Bulgaria.

We at V-TAC concluded a very successful 2019, fueled by accelerating growth in our newly launched PRO-Series product range. Developed in partnership with Samsung, the unprecedented popularity of the PRO-Series led to the product line's expansion to meet customer requirements. V-TAC's flagship product range, the PRO-Series feature LEDs from Samsung and five-year warranties.



Unwilling to sit back, V-TAC followed up the successful launch of PRO-Series in 2018 with the all-new Evolution Series in 2019. By utilizing the latest in LED technology to offer a superior 160 Lumens per Watt output, V-TAC Evolution Series offer a total fusion of super-bright light, reliability, and energy savings.

The Evolution Series is just one of many product lines that we will be developing in the future as we continue our path to a brighter future.

INTRODUCING THE NEW SERIES



Following are the new series that we plan to develop more in the coming year.



WiFi-supported home lighting system simultaneously controlled through the VTAC app; works with Amazon Alexa & Google Home.



Long-lasting, fast-charging data cables for everyday use. Includes a wide range of cable finish and connectors for different usage types.



WiFi-supported home solutions to convert any device into a smart device, and ultimately convert any home into a smart home. Have a systematic, unified control on all your smart devices through the official V-TAC app, Amazon Alexa, and Google Home.



Power strips with surge protectors and lighted switches, cable reels, adapters, and direct USB ports — all designed to bring convenience and safety to modern electrical needs.



Premium quality battery packs for any device with extensive features such as power capacity, battery indicators, and more to power up the modern lifestyle.



New series of wireless speakers devices with various modes & wireless controls for a dynamic sound experience & maximum portability.

Download Our Retail Catalog:
<http://tiny.cc/9dgrcz>



LED Flood Lights - 08

LED Flood Lights

White | Grey | Black



PAGE
10

LED Flood Lights

PIR Sensor White | Black



PAGE
32

LED Flood Lights

Rechargeable FloodLights

NEW ADDITION



PAGE
36

LED Flood Lights

Sports Light



PAGE
40

LED Flood Lights

Super Pro Series



PAGE
42

LED Street Lights - 44

Street Lights

Super Pro Series



PAGE
46

LED Garden Light

Super Pro Series



PAGE
48

Street Lights

140 Lumen/w



PAGE
50

Street Lights

120 Lumen/w



PAGE
54

Street Lights



PAGE
58

LED Highbays - 60

Reflector Highbays

High Lumens



PAGE
62

LED UFO Highbays

120 Lumen/w



PAGE
66

LED Linear Lights

LED Low Bay Lights



PAGE
70

LED Highbays

LED Canopy Light



PAGE
72

LED Panels - 74

LED Big Panels



NEW ADDITION



PAGE
76

LED Mini Panels

Adjustable Panels



PAGE
78

LED Mini Panels

Premium Series Panels



PAGE
82

LED Mini Panels

Edge Series



PAGE
86

LED Tubes - 90

LED Tubes

G13-T8 -Nano Plastic Tube



PAGE
92

Fixtures with LED

LED Prismatic Fittings



PAGE
98

Fixtures with LED

LED Batten Fitting

NEW ADDITION



PAGE
102

Fixtures with LED

CCT Changeable Batten Fitting



PAGE
106

Fixtures with LED

LED Waterproof Fittings



PAGE
108

LED Linear Lights - 116

Linear Lights

Linear Hanging Lights



PAGE
118

Linear Lights

Recessed Linear



PAGE
130

Linear Lights

Linear Trunking



PAGE
134

Magnetic Track Lights

Up-down Lights

NEW



PAGE
138

LED TrackLights

4 Line TrackLights



PAGE
146

LED Bulkhead and DownLights - 152

2D Bulkhead

Emergency Battery Backup and Sensor

NEW ADDITION



PAGE
154

Reflector Downlight



PAGE
168

LED Down Lights

Fire Rated Downlight



PAGE
172

LED Down Lights

LED Cabinet & Night Lights



PAGE
176

LED Solar Lights

LED Solar Wall and Bollard Lights

NEW ADDITION



PAGE
178

LED Emergency Lights - 180

Exit Light

Surface & Recessed



PAGE
182

Exit Light

Bulkhead



PAGE
183

LED Strip Lights - 184

LED Strip Lights

CRI >95

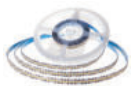

PAGE
186

LED Strip Lights

Neon Flex Light



PAGE
187

LED Spot Lights - 188

LED Spot Lights

LED Capsules Lights



PAGE
190

LED Spot Lights

LED GU10 Lights



PAGE
191

LED Spot Lights

MR16 | GU10



PAGE
192

LED Filament Bulbs - 194

LED Bulbs

evolution



PAGE
196

LED Bulbs

Amber Filament Bulbs



PAGE
198

LED Filament Bulbs

Clear Filament Bulbs



PAGE
200

LED Plastic Bulbs - 203

LED Plastic Bulbs

High Lumen Bulbs



PAGE
204

LED Plastic Bulbs

Candle | A58 | A65 | A80



PAGE
206

LED Plastic Bulbs

Reflectors & PAR Bulbs



PAGE
215

LED Plastic Bulbs

UFO Bulbs



PAGE
217

LED Plastic Bulbs

LED Big Bulb



PAGE
219



LED FLOODLIGHTS

V-TAC's LED Floodlights are manufactured with industry-leading components to deliver an exceptional performance, making them the perfect choice for efficient outdoor lighting. Each unit is designed and made of diecast Aluminium for extreme durability. With the IP65 rating, all the floodlights in this series are also waterproof and dustproof.

This extensive range of floodlights is ready to impress in terms of efficiency brought by the Samsung LED chip. The auto-cutoff function comes with the PIR series which disables the sensor with a switch.

APPLICATION

Recommended for any outdoor lighting application in residential, commercial, and industrial areas

V-TAC[®]
INNOVATIVE LED LIGHTING





KEY FEATURES

- 10w to 1000w
- IP65 rating — high-quality components used to ensure waterproof/airtight performance
- Modern and strong diecast Aluminium enclosure with a minimalistic design, for high-end support and design
- Product category includes high-lumen, slimline, PIR series, rechargeable, work floodlight, and sports floodlights
- Select units are inclusive of a 1-metre wire for convenience and easy installation



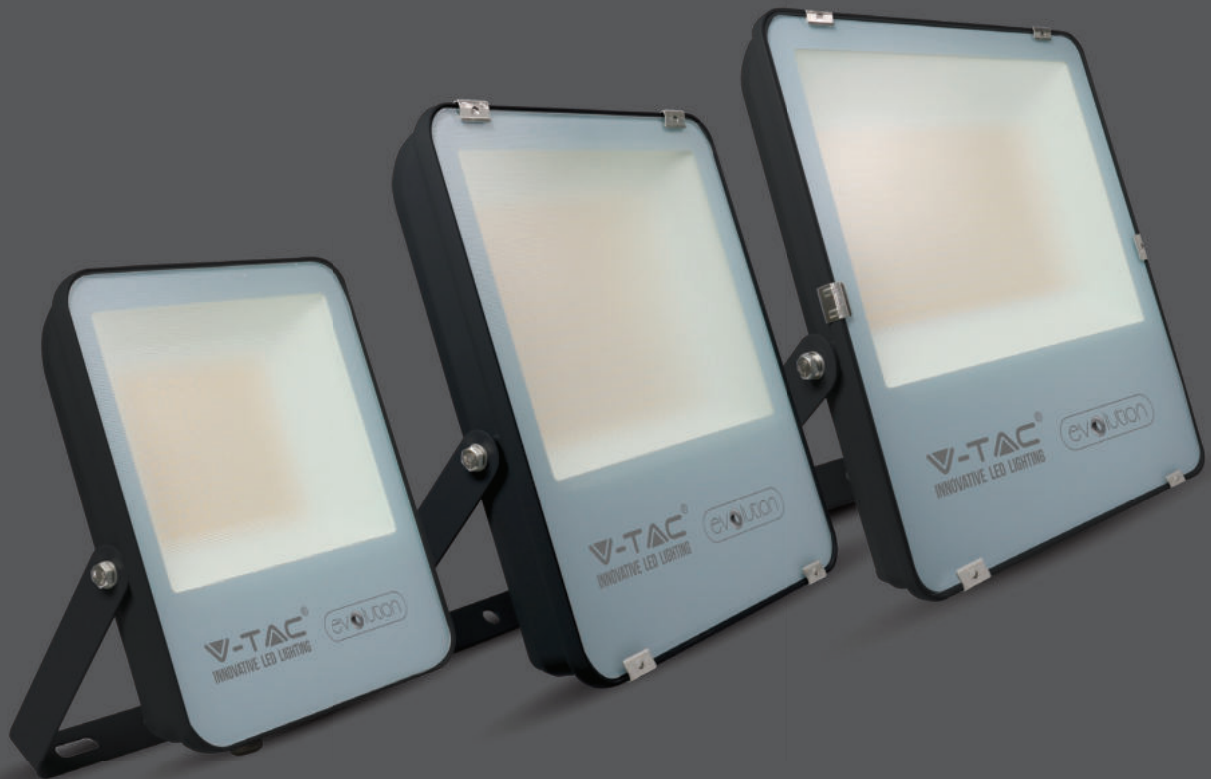

LED FLOODLIGHTS

Evolution Series Floodlight



Only from v-tac — the first and only led flood lights with 160 lumens per watt rating from the super bright series offer superior efficiency and great energy savings.

- Aluminium body
- 100° beam angle
- 30,000-hr lifespan
- CRI: >70
- PF: >0.9
- AC:220-240V,50Hz
- IP65 Rating



VT-4961

SKU: 5918 - 4000K DAY WHITE
SKU: 5919 - 6400K WHITE

WATTS	LUMENS	BOX QTY.
50w	8000lm	10 pcs

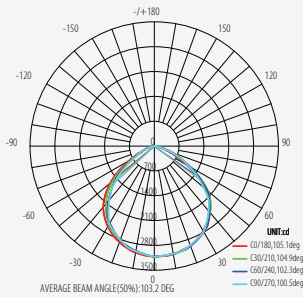

Super BRIGHT
160
LUMENS/W

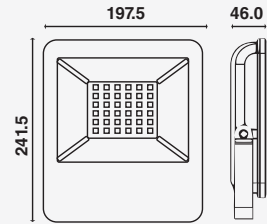

VT-49161

SKU: 5920 - 4000K DAY WHITE
SKU: 5921 - 6400K WHITE

WATTS	LUMENS	BOX QTY.
100w	16000lm	4 pcs

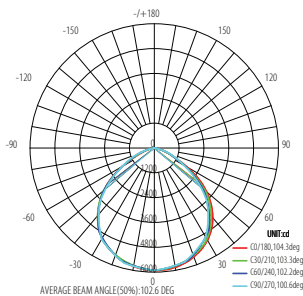

Super BRIGHT
160
LUMENS/W

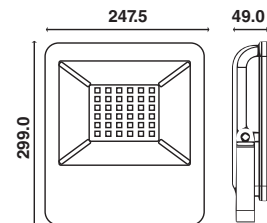

① METER WIRE



VT-49261

SKU: 5922 - 4000K DAY WHITE
SKU: 5923 - 6400K WHITE

WATTS	LUMENS	BOX QTY.
200w	32000lm	2 pcs

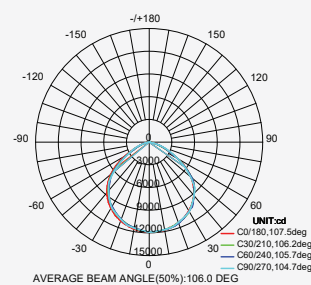

Super BRIGHT
160
LUMENS/W

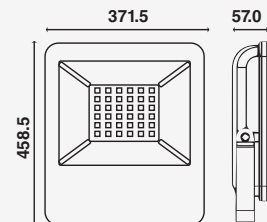

① METER WIRE



LED FLOODLIGHTS

Slimline-White Body-High Lumen



120
lm/W

More bright, energy efficient
50% better than normal LED

The V-TAC LED High Lumen Floodlight offers energy efficient, high output illumination for intensive lighting applications. This series consumes around 80% less energy than traditional outdoor lighting through pioneering optics and the latest LED technology from Samsung.

- Diecast aluminium body
- 100° beam angle
- 30,000-hr lifespan
- CRI: >80
- PF: >0.9
- AC:220-240V,50Hz
- IP65 Rating

LUMINOUS INTENSITY DISTRIBUTION DIAGRAM

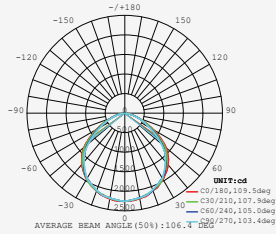

VT-56-W

SKU: 762 | 4000K DAY WHITE
 SKU: 763 | 6400K WHITE

120
 Lumen/W

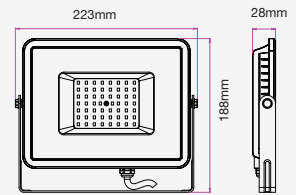

WATTS	LUMENS	BOX QTY.
50w	6000	8 pcs

LUMINOUS INTENSITY DISTRIBUTION DIAGRAM

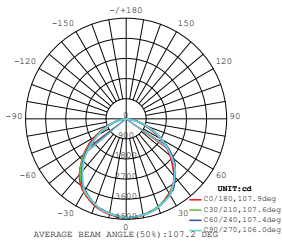

VT-106-W

SKU: 768 | 4000K DAY WHITE
 SKU: 769 | 6400K WHITE

120
 Lumen/W

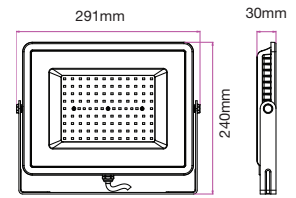

WATTS	LUMENS	BOX QTY.
100w	12000	4 pcs

① METER WIRE

LUMINOUS INTENSITY DISTRIBUTION DIAGRAM

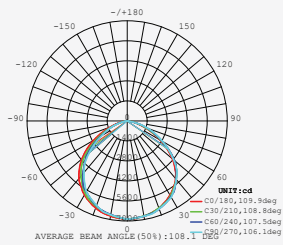

VT-156-W

SKU: 774 | 4000K DAY WHITE
 SKU: 775 | 6400K WHITE

120
 Lumen/W

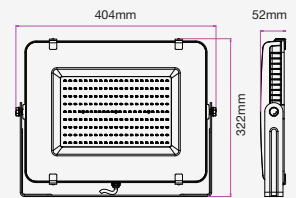

WATTS	LUMENS	BOX QTY.
150w	18000	2 pcs

① METER WIRE

LUMINOUS INTENSITY DISTRIBUTION DIAGRAM

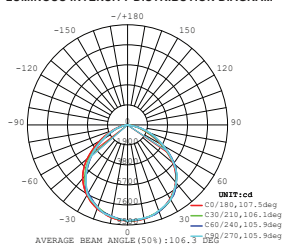

VT-206-W

SKU: 787 | 4000K DAY WHITE
 SKU: 788 | 6400K WHITE

120
 Lumen/W

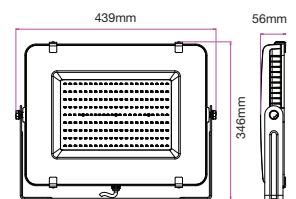

WATTS	LUMENS	BOX QTY.
200w	24000	2 pcs

① METER WIRE

LUMINOUS INTENSITY DISTRIBUTION DIAGRAM

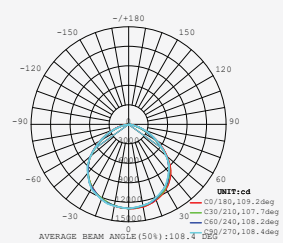

VT-306-W

SKU: 793 | 4000K DAY WHITE
 SKU: 794 | 6400K WHITE

120
 Lumen/W

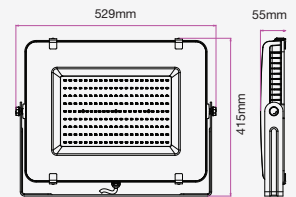

WATTS	LUMENS	BOX QTY.
300w	36000	2 pcs

① METER WIRE



LED FLOODLIGHTS

Slimline-Black Body-High Lumen



120
lm/W

More bright, energy efficient
50% better than normal LED

The V-TAC LED High Lumen Floodlight offers energy efficient, high output illumination for intensive lighting applications. This series consumes around 80% less energy than traditional outdoor lighting through pioneering optics and the latest LED technology from Samsung.

- Diecast aluminium body
- 100° beam angle
- 30,000-hr lifespan
- CRI: >80
- PF: >0.9
- AC:220-240V,50Hz
- IP65 Rating

LUMINOUS INTENSITY DISTRIBUTION DIAGRAM

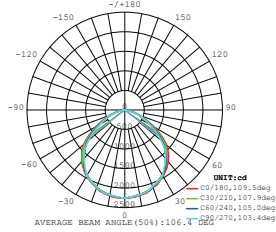

VT-56-B

SKU: 760 | 4000K DAY WHITE
 SKU: 761 | 6400K WHITE

120
 Lumen/W

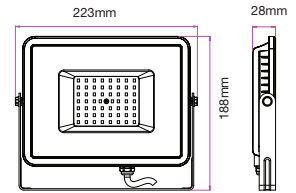

WATTS	LUMENS	BOX QTY.
50w	6000	8 pcs

LUMINOUS INTENSITY DISTRIBUTION DIAGRAM

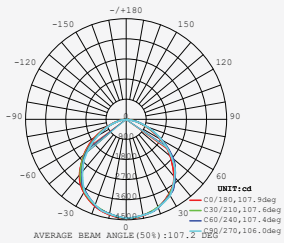

VT-106-B

SKU: 766 | 4000K DAY WHITE
 SKU: 767 | 6400K WHITE

120
 Lumen/W

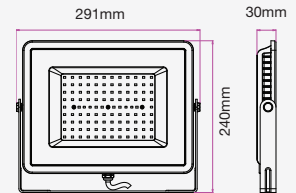

WATTS	LUMENS	BOX QTY.
100w	12000	4 pcs

① METER WIRE

LUMINOUS INTENSITY DISTRIBUTION DIAGRAM

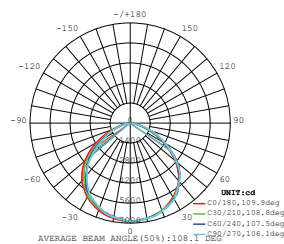

VT-156-B

SKU: 772 | 4000K DAY WHITE
 SKU: 773 | 6400K WHITE

120
 Lumen/W

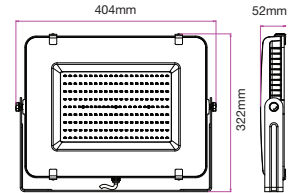

WATTS	LUMENS	BOX QTY.
150w	18000	2 pcs

① METER WIRE

LUMINOUS INTENSITY DISTRIBUTION DIAGRAM

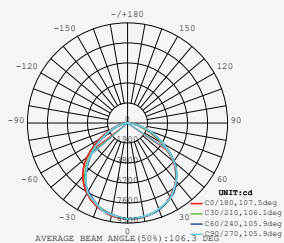

VT-206-B

SKU: 778 | 4000K DAY WHITE
 SKU: 779 | 6400K WHITE

120
 Lumen/W

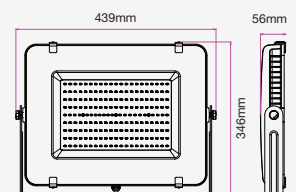

WATTS	LUMENS	BOX QTY.
200w	24000	2 pcs

① METER WIRE

LUMINOUS INTENSITY DISTRIBUTION DIAGRAM

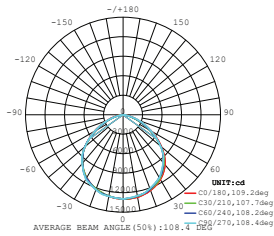

VT-306-B

SKU: 791 | 4000K DAY WHITE
 SKU: 792 | 6400K WHITE

WATTS	LUMENS	BOX QTY.
300w	36000	2 pcs

120
 Lumen/W

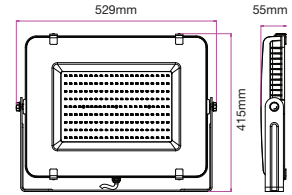

① METER WIRE

LUMINOUS INTENSITY DISTRIBUTION DIAGRAM

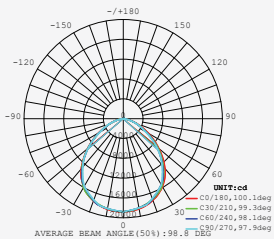

VT-405

SKU: 964 | 4000K DAY WHITE
 SKU: 965 | 6400K WHITE

WATTS	LUMENS	BOX QTY.
400w	48000	1 pcs

120
 Lumen/W

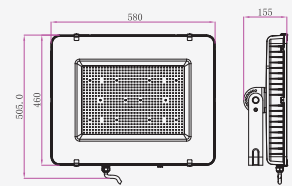

① METER WIRE

LUMINOUS INTENSITY DISTRIBUTION DIAGRAM

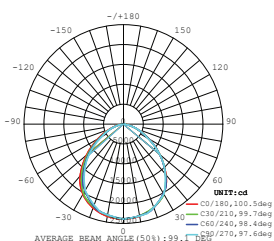

VT-505

SKU: 966 | 4000K DAY WHITE
 SKU: 967 | 6400K WHITE

WATTS	LUMENS	BOX QTY.
500w	60000	1 pcs

120
 Lumen/W

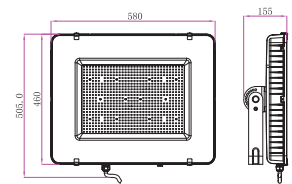

① METER WIRE

LUMINOUS INTENSITY DISTRIBUTION DIAGRAM

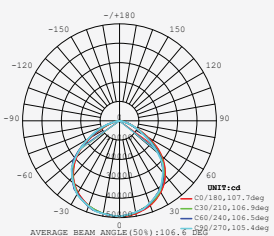

VT-1055

SKU: 968 | 4000K DAY WHITE
 SKU: 969 | 6400K WHITE

WATTS	LUMENS	BOX QTY.
1000w	120000	1 pcs

120
 Lumen/W

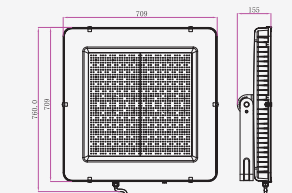

① METER WIRE

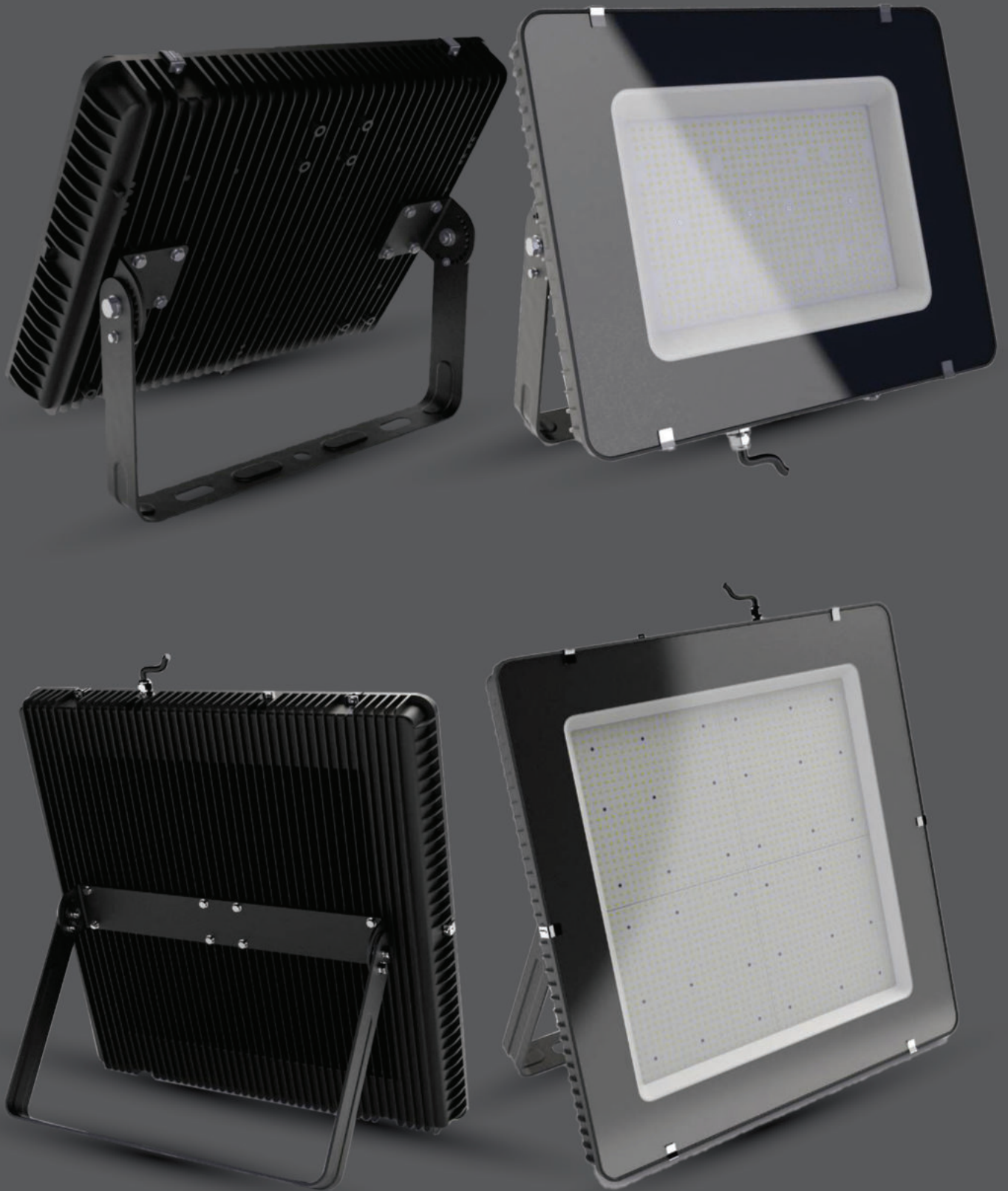

LED FLOODLIGHTS

www.v-tac.eu | www.vtacexports.com



IP65
RATING

5 YEAR
WARRANTY*

LED FLOODLIGHTS

Slimline-Grey Body-High Lumen

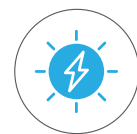

120
lm/W

More bright, energy efficient
50% better than normal LED

The V-TAC LED High Lumen Floodlight offers energy efficient, high output illumination for intensive lighting applications. This series consumes around 80% less energy than traditional outdoor lighting through pioneering optics and the latest LED technology from Samsung.

- Diecast aluminium body
- 100° beam angle
- 30,000-hr lifespan
- CRI: >80
- CRI: >80
- PF: >0.9
- AC:220-240V,50Hz
- IP65 Rating

LUMINOUS INTENSITY DISTRIBUTION DIAGRAM

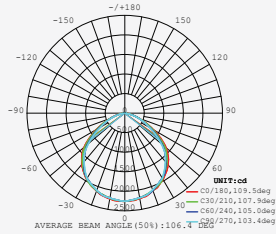

VT-56-G

SKU: 764 | 4000K DAY WHITE
 SKU: 765 | 6400K WHITE

120
 Lumen/W

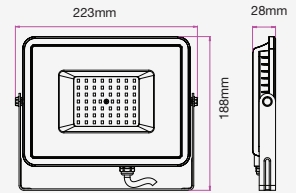

WATTS	LUMENS	BOX QTY.
50w	6000	8 pcs

LUMINOUS INTENSITY DISTRIBUTION DIAGRAM

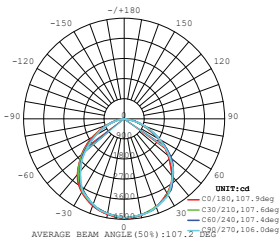

VT-106-G

SKU: 770 | 4000K DAY WHITE
 SKU: 771 | 6400K WHITE

120
 Lumen/W

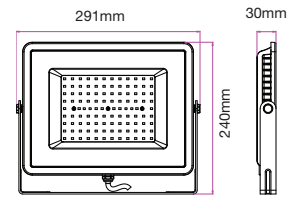

WATTS	LUMENS	BOX QTY.
100w	12000	4 pcs

① METER WIRE

LUMINOUS INTENSITY DISTRIBUTION DIAGRAM

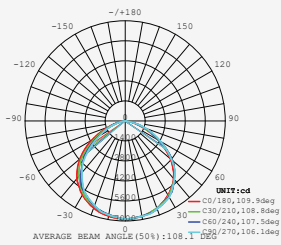

VT-156-G

SKU: 776 | 4000K DAY WHITE
 SKU: 777 | 6400K WHITE

120
 Lumen/W

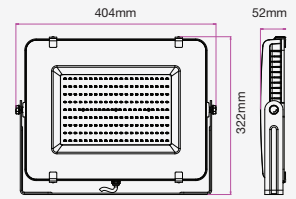

WATTS	LUMENS	BOX QTY.
150w	18000	2 pcs

① METER WIRE

LUMINOUS INTENSITY DISTRIBUTION DIAGRAM

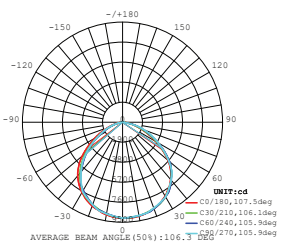

VT-206-G

SKU: 789 | 4000K DAY WHITE
 SKU: 790 | 6400K WHITE

120
 Lumen/W

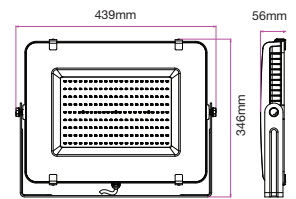

WATTS	LUMENS	BOX QTY.
200w	24000	2 pcs

① METER WIRE

LUMINOUS INTENSITY DISTRIBUTION DIAGRAM

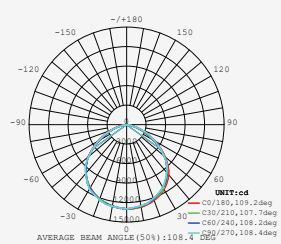

VT-306-G

SKU: 795 | 4000K DAY WHITE
 SKU: 796 | 6400K WHITE

120
 Lumen/W

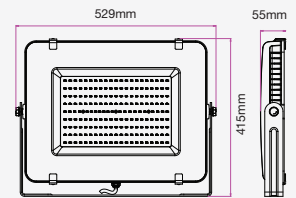

WATTS	LUMENS	BOX QTY.
300w	36000	2 pcs

① METER WIRE



LED FLOODLIGHTS

Slimline-White Body

V-TAC's PRO Series LED floodlights are equipped with Samsung LED chips for a well-diffused, high-performance outdoor lighting encased in a diecast IP65 body for durability. Available in 10w to 300 watts, in a clean and ivory white finish. Select models come with a one (1) metre wire.

- **Diecast body**
- **100° beam angle**
- **30,000-hr lifespan**
- **CRI: >80**
- **PF: >0.9**
- **AC:220-240V,50Hz**
- **IP65 Rating**

LUMINOUS INTENSITY DISTRIBUTION DIAGRAM

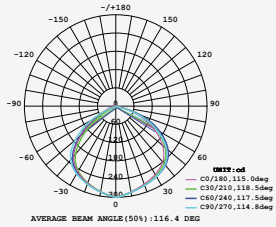

VT-10-W

SKU: 427 | 3000K WARM WHITE
 SKU: 428 | 4000K DAY WHITE
 SKU: 429 | 6400K WHITE

WATTS	LUMENS	BOX QTY.
10w	800	20 pcs

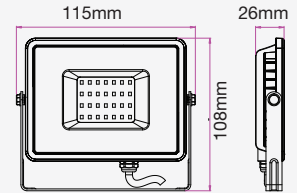

LUMINOUS INTENSITY DISTRIBUTION DIAGRAM

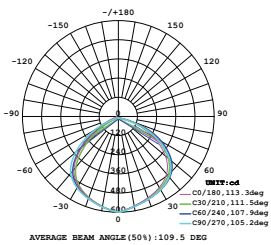

VT-20-W

SKU: 442 | 3000K WARM WHITE
 SKU: 443 | 4000K DAY WHITE
 SKU: 444 | 6400K WHITE

WATTS	LUMENS	BOX QTY.
20w	1600	20 pcs

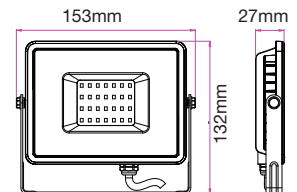

LUMINOUS INTENSITY DISTRIBUTION DIAGRAM

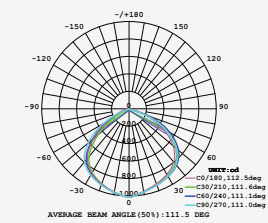

VT-30-W

SKU: 403 | 3000K WARM WHITE
 SKU: 404 | 4000K DAY WHITE
 SKU: 405 | 6400K WHITE

WATTS	LUMENS	BOX QTY.
30w	2400	10 pcs

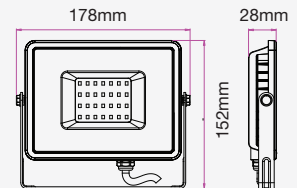

LUMINOUS INTENSITY DISTRIBUTION DIAGRAM

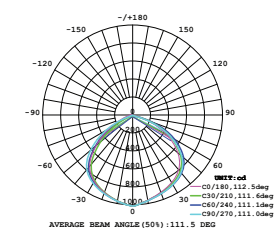

VT-30-1-W

SKU: 950 | 6400K WHITE

WATTS	LUMENS	BOX QTY.
30w	2400	10 pcs

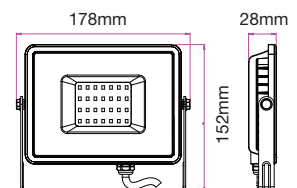

1 METER WIRE

LUMINOUS INTENSITY DISTRIBUTION DIAGRAM

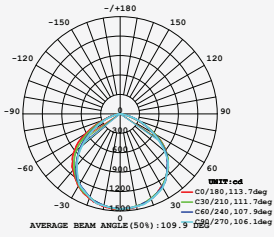

VT-50-W

SKU: 409 | 3000K WARM WHITE
 SKU: 410 | 4000K DAY WHITE
 SKU: 411 | 6400K WHITE

WATTS	LUMENS	BOX QTY.
50w	4000	8 pcs

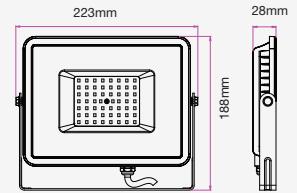

LUMINOUS INTENSITY DISTRIBUTION DIAGRAM

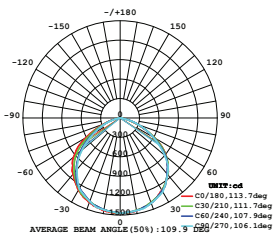

VT-50-1-W

SKU: 952 | 6400K WHITE

WATTS	LUMENS	BOX QTY.
50w	4000	8 pcs

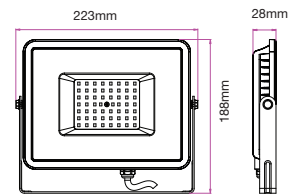

① METER WIRE

LUMINOUS INTENSITY DISTRIBUTION DIAGRAM

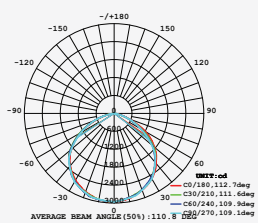

VT-100-W

SKU: 415 | 3000K WARM WHITE
 SKU: 416 | 4000K DAY WHITE
 SKU: 417 | 6400K WHITE

WATTS	LUMENS	BOX QTY.
100w	8000	4 pcs

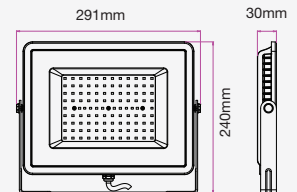

① METER WIRE

LUMINOUS INTENSITY DISTRIBUTION DIAGRAM

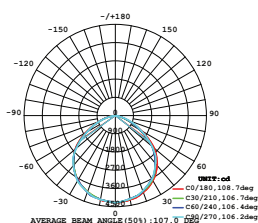

VT-150-W

SKU: 478 | 3000K WARM WHITE
 SKU: 479 | 4000K DAY WHITE
 SKU: 480 | 6400K WHITE

WATTS	LUMENS	BOX QTY.
150w	12000	2 pcs

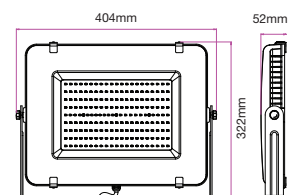

① METER WIRE

LUMINOUS INTENSITY DISTRIBUTION DIAGRAM

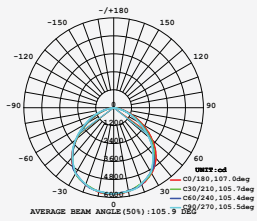

VT-200-W

SKU: 420 | 4000K DAY WHITE
 SKU: 421 | 6400K WHITE

WATTS	LUMENS	BOX QTY.
200w	16000	2 pcs

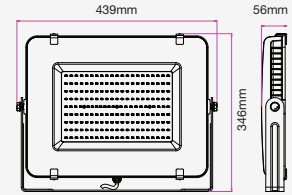

1 METER WIRE

LUMINOUS INTENSITY DISTRIBUTION DIAGRAM

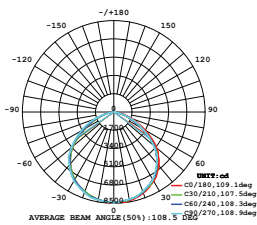

VT-300-W

SKU: 486 | 4000K DAY WHITE
 SKU: 487 | 6400K WHITE

WATTS	LUMENS	BOX QTY.
300w	24000	2 pcs

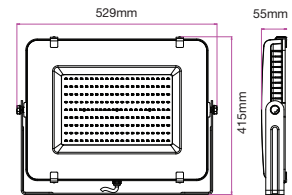

1 METER WIRE





LED FLOODLIGHTS

Slimline-Black Body

V-TAC's PRO Series LED floodlights are equipped with Samsung LED chips for a well-diffused, high-performance outdoor lighting encased in a diecast IP65 body for durability. Available in 10w to 300 watts, in a classic, jet black finish. Select models come with a one (1) metre wire.

- **Diecast body**
- **100° beam angle**
- **30,000-hr lifespan**
- **CRI: >80**
- **PF: >0.9**
- **AC:220-240V,50Hz**
- **IP65 Rating**

LUMINOUS INTENSITY DISTRIBUTION DIAGRAM

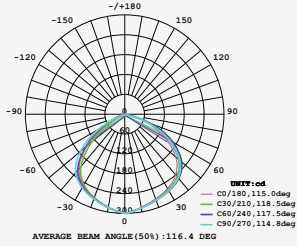

VT-10-1-B

SKU: 947 | 6400K WHITE

WATTS	LUMENS	BOX QTY.
10w	800	20 pcs

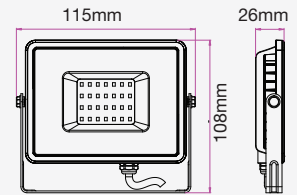

① METER WIRE

LUMINOUS INTENSITY DISTRIBUTION DIAGRAM

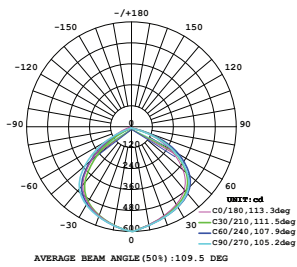

VT-20-1-B

SKU: 20012 | 4000K DAY WHITE
 SKU: 948 | 6400K WHITE

WATTS	LUMENS	BOX QTY.
20w	1600	20 pcs

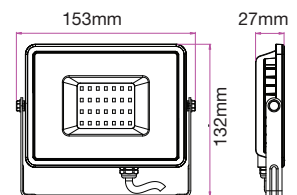

① METER WIRE

LUMINOUS INTENSITY DISTRIBUTION DIAGRAM

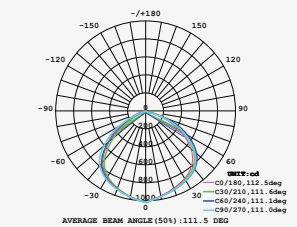

VT-30-1-B

SKU: 20013 | 4000K DAY WHITE
 SKU: 949 | 6400K WHITE

WATTS	LUMENS	BOX QTY.
30w	2400	10 pcs

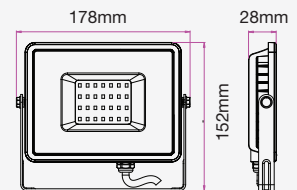

① METER WIRE

LUMINOUS INTENSITY DISTRIBUTION DIAGRAM

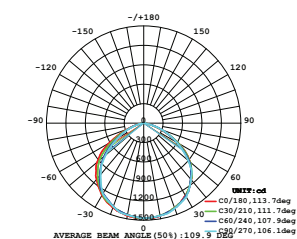

VT-50-1-B

SKU: 20014 | 4000K DAY WHITE
 SKU: 951 | 6400K WHITE

WATTS	LUMENS	BOX QTY.
50w	4000	8 pcs

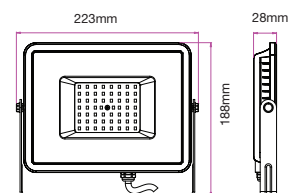

① METER WIRE

LUMINOUS INTENSITY DISTRIBUTION DIAGRAM

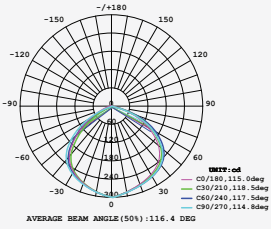

VT-10-B

- SKU: 424 | 3000K WARM WHITE
- SKU: 425 | 4000K DAY WHITE
- SKU: 426 | 6400K WHITE

WATTS	LUMENS	BOX QTY.
10w	800	20 pcs

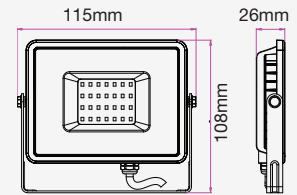

LUMINOUS INTENSITY DISTRIBUTION DIAGRAM

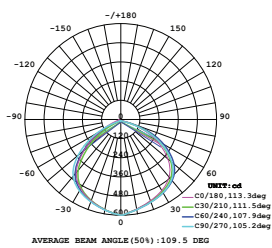

VT-20-B

- SKU: 439 | 3000K WARM WHITE
- SKU: 440 | 4000K DAY WHITE
- SKU: 441 | 6400K WHITE

WATTS	LUMENS	BOX QTY.
20w	1600	20 pcs

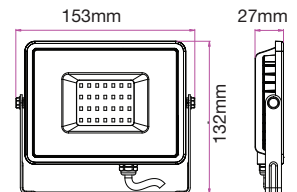

LUMINOUS INTENSITY DISTRIBUTION DIAGRAM

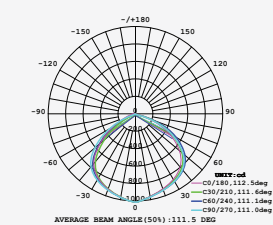

VT-30-B

- SKU: 400 | 3000K WARM WHITE
- SKU: 401 | 4000K DAY WHITE
- SKU: 402 | 6400K WHITE

WATTS	LUMENS	BOX QTY.
30w	2400	10 pcs

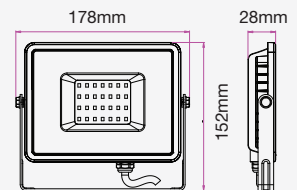

LUMINOUS INTENSITY DISTRIBUTION DIAGRAM

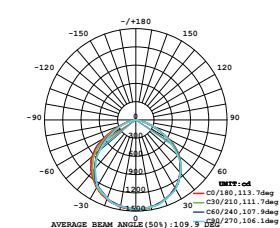

VT-50-B

- SKU: 406 | 3000K WARM WHITE
- SKU: 407 | 4000K DAY WHITE
- SKU: 408 | 6400K WHITE

WATTS	LUMENS	BOX QTY.
50w	4000	8 pcs

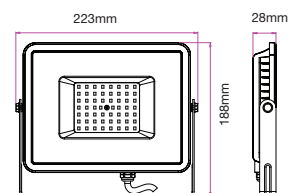

LUMINOUS INTENSITY DISTRIBUTION DIAGRAM

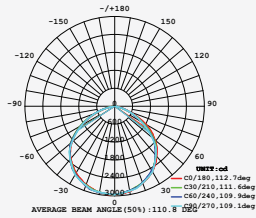

VT-100-B

- SKU: 412 | 3000K WARM WHITE
- SKU: 413 | 4000K DAY WHITE
- SKU: 414 | 6400K WHITE

WATTS	LUMENS	BOX QTY.
100w	8000	4 pcs

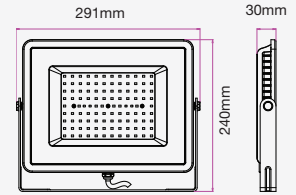

① METER WIRE

LUMINOUS INTENSITY DISTRIBUTION DIAGRAM

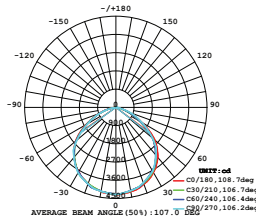

VT-150-B

- SKU: 475 | 3000K WARM WHITE
- SKU: 476 | 4000K DAY WHITE
- SKU: 477 | 6400K WHITE

WATTS	LUMENS	BOX QTY.
150w	12000	2 pcs

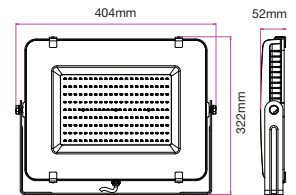

① METER WIRE

LUMINOUS INTENSITY DISTRIBUTION DIAGRAM

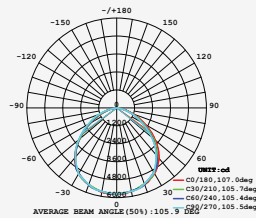

VT-200-B

- SKU: 418 | 4000K DAY WHITE
- SKU: 419 | 6400K WHITE

WATTS	LUMENS	BOX QTY.
200w	16000	2 pcs

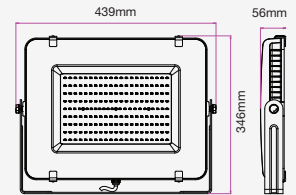

① METER WIRE

LUMINOUS INTENSITY DISTRIBUTION DIAGRAM

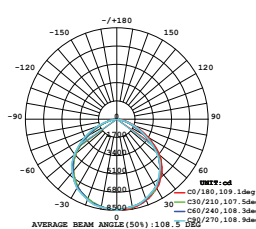

VT-300-B

- SKU: 422 | 4000K DAY WHITE
- SKU: 423 | 6400K WHITE

WATTS	LUMENS	BOX QTY.
300w	24000	2 pcs

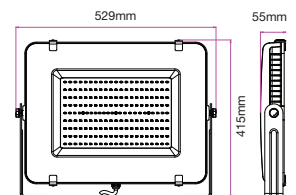

① METER WIRE



LED FLOODLIGHTS

Slimline-Grey Body

V-TAC's PRO Series LED floodlights are equipped with Samsung LED chips for a well-diffused, high-performance outdoor lighting encased in a diecast IP65 body for durability. Available in 10w to 300 watts, in a modern, neutral grey finish. Select models come with a one (1) metre wire.

- **Diecast body**
- **100° beam angle**
- **30,000-hr lifespan**
- **CRI: >80**
- **PF: >0.9**
- **AC:220-240V,50Hz**
- **IP65 Rating**

LUMINOUS INTENSITY DISTRIBUTION DIAGRAM

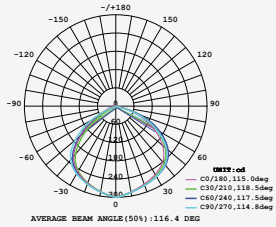

VT-10-G

- SKU: 430 | 3000K WARM WHITE
- SKU: 431 | 4000K DAY WHITE
- SKU: 432 | 6400K WHITE

WATTS	LUMENS	BOX QTY.
10w	800	20 pcs

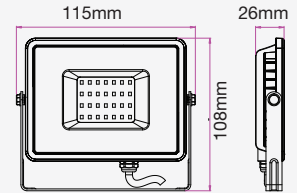

LUMINOUS INTENSITY DISTRIBUTION DIAGRAM

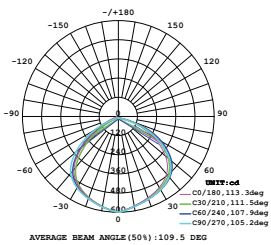

VT-20-G

- SKU: 445 | 3000K WARM WHITE
- SKU: 446 | 4000K DAY WHITE
- SKU: 447 | 6400K WHITE

WATTS	LUMENS	BOX QTY.
20w	1600	20 pcs

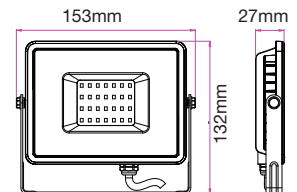

LUMINOUS INTENSITY DISTRIBUTION DIAGRAM

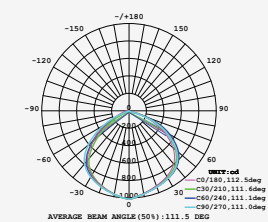

VT-30-G

- SKU: 454 | 3000K WARM WHITE
- SKU: 455 | 4000K DAY WHITE
- SKU: 456 | 6400K WHITE

WATTS	LUMENS	BOX QTY.
30w	2400	10 pcs

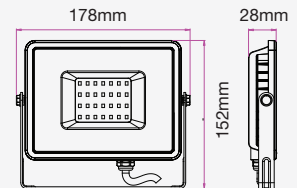

LUMINOUS INTENSITY DISTRIBUTION DIAGRAM

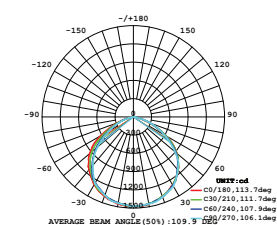

VT-50-G

- SKU: 463 | 3000K WARM WHITE
- SKU: 464 | 4000K DAY WHITE
- SKU: 465 | 6400K WHITE

WATTS	LUMENS	BOX QTY.
50w	4000	8 pcs

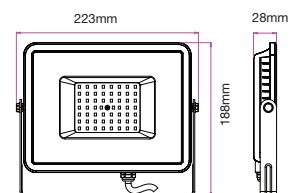

LUMINOUS INTENSITY DISTRIBUTION DIAGRAM

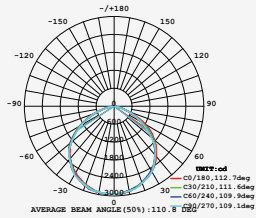

VT-100-G

SKU: 472 | 3000K WARM WHITE
 SKU: 473 | 4000K DAY WHITE
 SKU: 474 | 6400K WHITE

WATTS	LUMENS	BOX QTY.
100w	8000	4 pcs

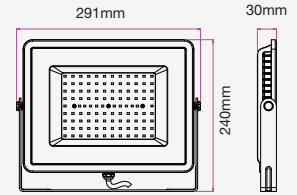

① METER WIRE

LUMINOUS INTENSITY DISTRIBUTION DIAGRAM

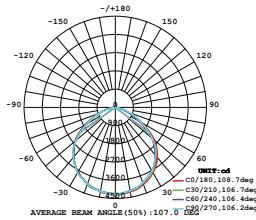

VT-150-G

SKU: 481 | 3000K WARM WHITE
 SKU: 482 | 4000K DAY WHITE
 SKU: 483 | 6400K WHITE

WATTS	LUMENS	BOX QTY.
150w	12000	2 pcs

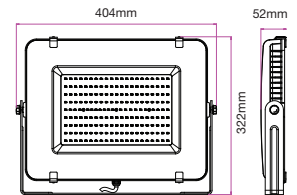

① METER WIRE

LUMINOUS INTENSITY DISTRIBUTION DIAGRAM

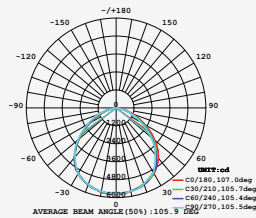

VT-200-G

SKU: 484 | 4000K DAY WHITE
 SKU: 485 | 6400K WHITE

WATTS	LUMENS	BOX QTY.
200w	16000	2 pcs

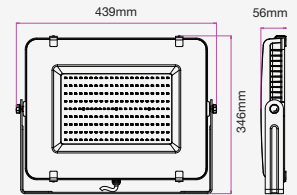

① METER WIRE

LUMINOUS INTENSITY DISTRIBUTION DIAGRAM

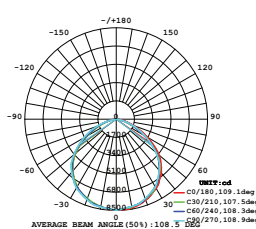

VT-300-G

SKU: 488 | 4000K DAY WHITE
 SKU: 489 | 6400K WHITE

WATTS	LUMENS	BOX QTY.
300w	24000	2 pcs

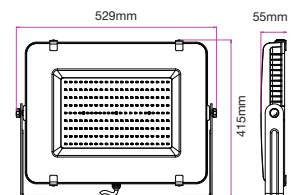

① METER WIRE



LED FLOODLIGHTS

www.v-tac.eu | www.vtacexports.com



LED FLOODLIGHTS

PIR Sensor White Body

Incorporating security functionalities, V-TAC offers a new range of LED floodlights equipped with PIR sensors and Samsung LED for an even better, high-end performance. Can be used as a regular floodlight through the Auto Cut-off function(manual override). Widely used for security lighting in residential, commercial, or industrial areas.

- **SMD Samsung LED**
- **30,000-hr lifespan**
- **100° Beam Angle**
- **AC:220-240V,50Hz**
- **CRI: >70**
- **PF>0.7 for 10,20w; 0.9 for 30,50w**
- **On/Off cycle: >15000**
- **Instant start in <1sec**
- **Die casting Aluminium Body**
- **Auto-cutoff function: disable sensor with a switch**
- **Detection range:120°**
- **Detection distance:2-8m**
- **Time delay: MINI2+-3sec MAX6+-2min**
- **Installation height: 1.8-2.5m**

LUMINOUS INTENSITY DISTRIBUTION DIAGRAM

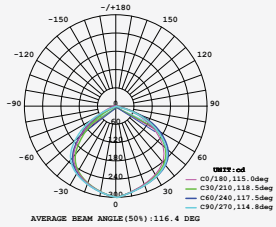

VT-10-S-W

- SKU: 433 | 3000K WARM WHITE
- SKU: 434 | 4000K DAY WHITE
- SKU: 435 | 6400K WHITE

WATTS	LUMENS	BOX QTY.
10w	800	20 pcs

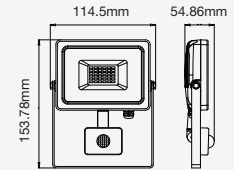

① METER WIRE

LUMINOUS INTENSITY DISTRIBUTION DIAGRAM

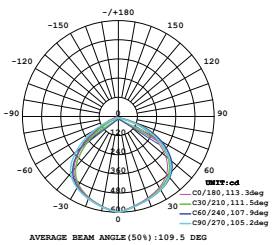

VT-20-S-W

- SKU: 448 | 3000K WARM WHITE
- SKU: 449 | 4000K DAY WHITE
- SKU: 450 | 6400K WHITE

WATTS	LUMENS	BOX QTY.
20w	1600	20 pcs

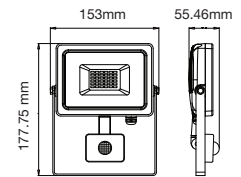

① METER WIRE

LUMINOUS INTENSITY DISTRIBUTION DIAGRAM

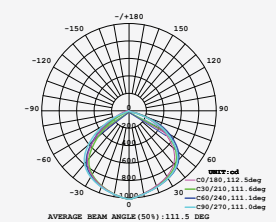

VT-30-S-W

- SKU: 457 | 3000K WARM WHITE
- SKU: 458 | 4000K DAY WHITE
- SKU: 459 | 6400K WHITE

WATTS	LUMENS	BOX QTY.
30w	2400	20 pcs

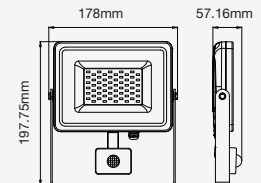

① METER WIRE

LUMINOUS INTENSITY DISTRIBUTION DIAGRAM

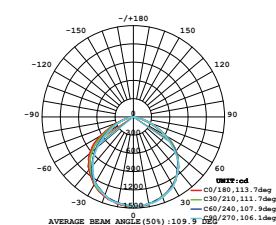

VT-50-S-W

- SKU: 466 | 3000K WARM WHITE
- SKU: 467 | 4000K DAY WHITE
- SKU: 468 | 6400K WHITE

WATTS	LUMENS	BOX QTY.
50w	4000	10 pcs

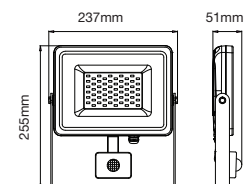

① METER WIRE



LED FLOODLIGHTS

PIR Sensor Black Body

Incorporating security functionalities, V-TAC offers a new range of LED floodlights equipped with PIR sensors and Samsung LED for an even better, high-end performance. Can be used as a regular floodlight through the Auto Cut-off function(manual override). Widely used for security lighting in residential, commercial, or industrial areas.

- **SMD Samsung LED**
- **30,000-hr lifespan**
- **100° Beam Angle**
- **AC:220-240V,50Hz**
- **CRI: >70**
- **PF>0.7 for 10,20w; 0.9 for 30,50w**
- **On/Off cycle: >15000**
- **Instant start in <1sec**
- **Die casting Aluminium Body**
- **Auto-cutoff function: disable sensor with a switch**
- **Detection range:120°**
- **Detection distance:2-8m**
- **Time delay: MINI2+-3sec MAX6+-2min**
- **Installation height: 1.8-2.5m**

LUMINOUS INTENSITY DISTRIBUTION DIAGRAM

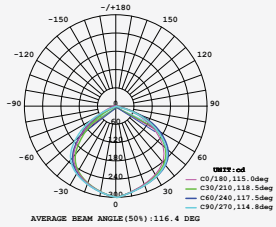

VT-10-S-B

NEW

- SKU: 436 | 3000K WARM WHITE
- SKU: 437 | 4000K DAY WHITE
- SKU: 438 | 6400K WHITE

WATTS	LUMENS	BOX QTY.
10w	800	20 pcs

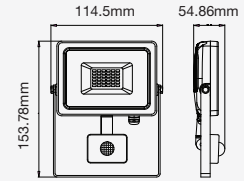

1 METER WIRE

LUMINOUS INTENSITY DISTRIBUTION DIAGRAM

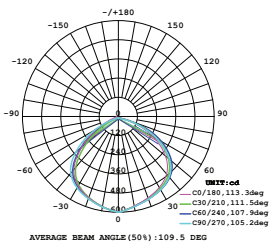

VT-20-S-B

- SKU: 451 | 3000K WARM WHITE
- SKU: 452 | 4000K DAY WHITE
- SKU: 453 | 6400K WHITE

WATTS	LUMENS	BOX QTY.
20w	1600	20 pcs

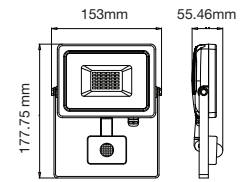

1 METER WIRE

LUMINOUS INTENSITY DISTRIBUTION DIAGRAM

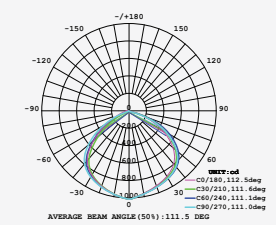

VT-30-S-B

- SKU: 460 | 3000K WARM WHITE
- SKU: 461 | 4000K DAY WHITE
- SKU: 462 | 6400K WHITE

WATTS	LUMENS	BOX QTY.
30w	2400	20 pcs

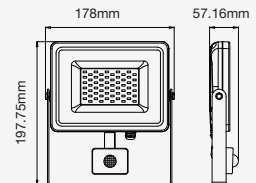

1 METER WIRE

LUMINOUS INTENSITY DISTRIBUTION DIAGRAM

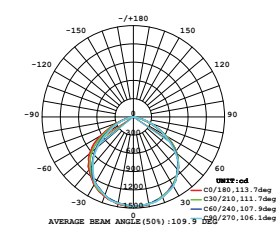

VT-50-S-B

- SKU: 469 | 3000K WARM WHITE
- SKU: 470 | 4000K DAY WHITE
- SKU: 471 | 6400K WHITE

WATTS	LUMENS	BOX QTY.
50w	4000	10 pcs

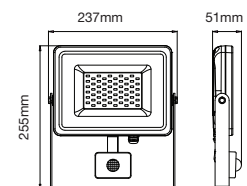

1 METER WIRE



MICRO SOCKET

RECHARGEABLE FLOODLIGHT

Strong, reliable portable lamp — V-TAC's new compact and rechargeable LED floodlights can easily be recharged through the micro socket & USB port making it perfect for home projects, garages, warehouses, car repair shops, parking lots, camping and more.

- **IP Rating - IP44**
- **AC: 100-240V**
- **On/Off cycle: >15000**
- **CRI>80**
- **Rechargeable**
- **30,000 Hours Life**
- **PF>0.9**
- **Beamangle: 100**

VT-10-R

SKU: 20038 | 4000K DAY WHITE
 SKU:503 | 6400K WHITE

WATTS	LUMENS	BOX QTY.
10w	700	20 pcs

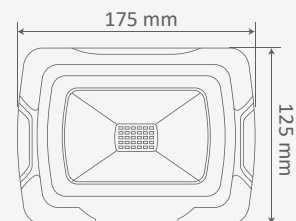
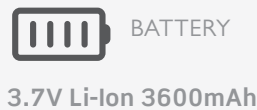

VT-11-R

SKU: 20037 | 4000K DAY WHITE
 SKU:502 | 6400K WHITE

WATTS	LUMENS	BOX QTY.
10w	700	20 pcs

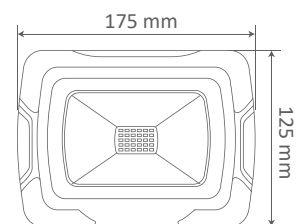
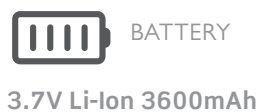

VT-20-R

SKU: 20039 | 4000K DAY WHITE
 SKU:504 | 6400K WHITE

WATTS	LUMENS	BOX QTY.
20w	1400	20 pcs

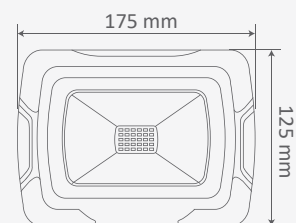
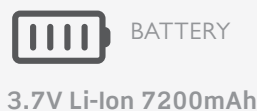



DUAL VOLTAGE
85V- 265V



METER WIRE

WORK FLOODLIGHT

Heavy-duty, reliable LED work floodlight — V-TAC's LED Work Light is designed with dual voltage AC:85-265V and comes with 3-metre wire. Built with optional EU/BS plug for direct connection, with adjustable stand and carry handle. Suitable for garages, workshops, basements, car repair shops and more.

- **Input AC:85-265V,50Hz**
- **CRI >80**
- **PF >0.9**
- **30,000 Life Hours**
- **100° Beam Angle**
- **Material Die cast aluminium**
- **3 Meter wire length**
- **IP44**

LUMINOUS INTENSITY DISTRIBUTION DIAGRAM

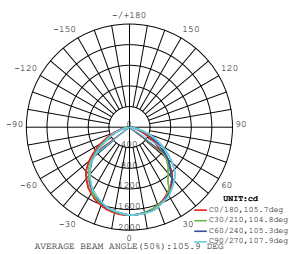

VT-51

SKU: 945 | 4000K DAY WHITE
 SKU: 946 | 6400K WHITE



EU PLUG

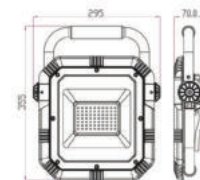

WATTS	LUMENS	BOX QTY.
50w	4000	8 pcs

LUMINOUS INTENSITY DISTRIBUTION DIAGRAM

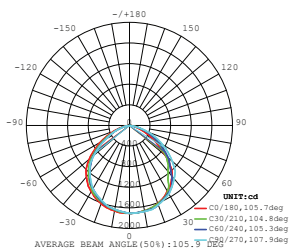

VT-51-BS

SKU: 20065 | 6400K WHITE



BS PLUG

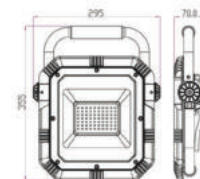

WATTS	LUMENS	BOX QTY.
50W	4000	8 pcs



WIDE VOLTAGE
100-265V

1.5
METER WIRE

IP65
RATING

YELLOW BODY FLOODLIGHT

- AC:100-265V,50/60Hz
- 100° beam angle
- 30,000-hr lifespan
- CRI >80
- PF >0.9
- IP65 Rating
- Material: Diecast Aluminum
- On/Off cycle: >15000
- BS Plug with 1.5 Meter Wire Length

5 YEAR
WARRANTY*

LUMINOUS INTENSITY DISTRIBUTION DIAGRAM

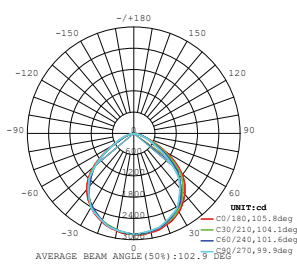

NEW

VT-58

SKU:20121 | 6400K WHITE

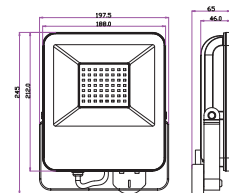

WATTS	LUMENS	BOX QTY.
50W	5000	10 pcs

LUMINOUS INTENSITY DISTRIBUTION DIAGRAM

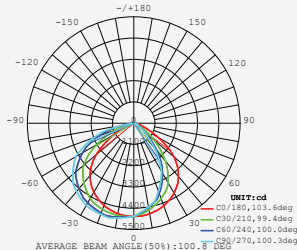

NEW

VT-108

SKU:20122 | 6400K WHITE

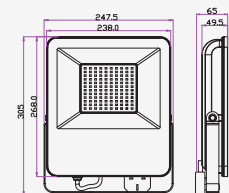

WATTS	LUMENS	BOX QTY.
100W	10000	4 pcs



METER WIRE

SLIM FLOODLIGHT - H STAND

Powerful, slim-built floodlight with heavy-duty H stand for high-quality outdoor lighting performance. The floodlight is tiltable/adjustable and comes with a three-metre wire for maximum portability. Perfect for industrial areas – construction sites, repair shops and garages, warehouses, etc.

- Input AC:220-240V,50Hz
- CRI >80
- PF >0.9
- 25,000 Life Hours
- 100° Beam Angle
- Material: Diecast Aluminum
- On/Off cycle: >15000
- H Stand with 3 meter wire (EU Plug)

5 YEAR
WARRANTY*

LUMINOUS INTENSITY DISTRIBUTION DIAGRAM

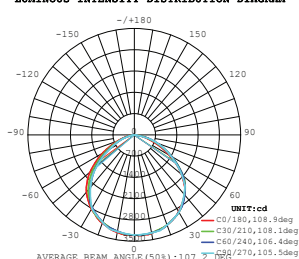

VT-109

SKU: 20124 | 4000K DAY WHITE
SKU: 20125 | 6400K WHITE



EU PLUG

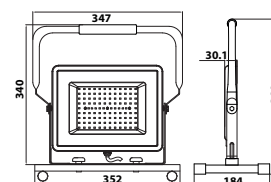

WATTS	LUMENS	BOX QTY.
100W	8000	10 pcs

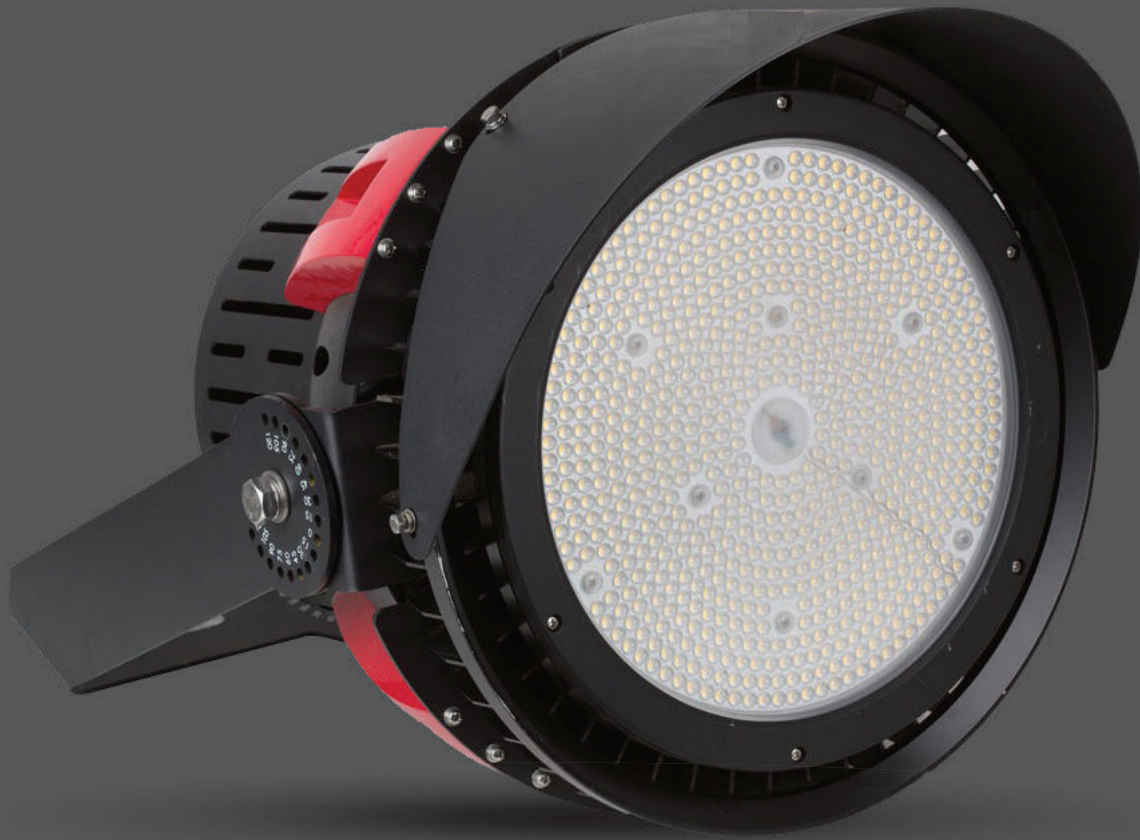

DIMMABLE



Your Reliable Power Partner

5 YEAR
WARRANTY*

LED FLOODLIGHTS

Sports Light

120
Lumen/W

The new LED Sports Light with Samsung LED offers excellent energy efficiency, low maintenance, and an unbreakable, strong design that can eliminate chances of breaking at ball strikes compared to traditional fluorescent and HID options.

- **Using MEAN WELL driver**
- **No Lead or Mercury content**
- **Life Hours of 30,000 Hours**
- **LED provided by Samsung**
- **Saves 80% energy**
- **IP65 Rating**

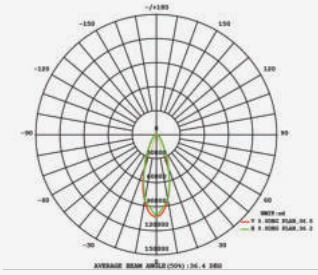

VT-500D

SKU: 490 | 5000K WHITE

WATTS	LUMENS	BEAM ANGLE	BOX QTY.
500w	67500	45°	1 pcs

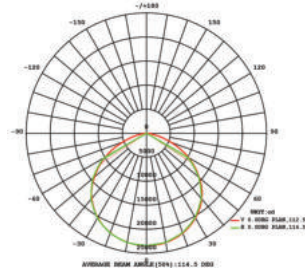
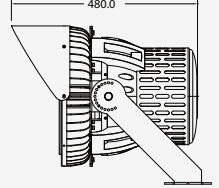
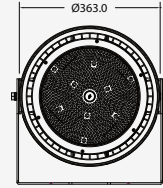

VT-501D

SKU: 493 | 5000K WHITE

WATTS	LUMENS	BEAM ANGLE	BOX QTY.
500w	67500	110°	1 pcs

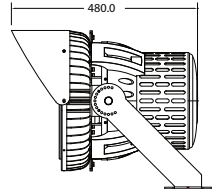
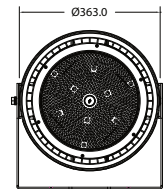



LED FLOODLIGHTS

LED Super Pro Floodlights



Available in 250W, 500W, and 1000W, our heavy-duty IP66 LED Floodlights are perfect for industrial lighting. Never worry about efficiency — these floodlights are equipped with highly acclaimed LEDs provided by Samsung and Mean Well drivers for energy saving and temperature dissipation excellence.

- AC: 100-277V
- IP66 Rating and strong die cast aluminum body for durability
- 50,000-hr lifespan
- 60° & 120° Beam Angle (Rotatable)
- CRI: >70
- PF: > 0.9

BEAM ANGLE 120°

VT-253D

SKU: 494 | 4000K DAY WHITE
SKU: 500 | 6400K WHITE

WATTS	LUMENS	BOX QTY.	WEIGHT
250w	30000	1 pcs	8KG

BEAM ANGLE 60°

VT-252D

SKU: 495 | 4000K DAY WHITE
SKU: 501 | 6400K WHITE

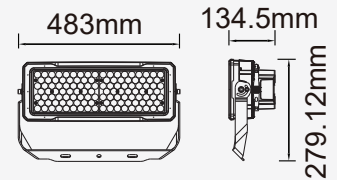

BEAM ANGLE 120°

VT-503D

SKU: 496 | 4000K DAY WHITE

WATTS	LUMENS	BOX QTY.	WEIGHT
500w	60000	1 pcs	20.5KG

BEAM ANGLE 60°

VT-502D

SKU: 497 | 4000K DAY WHITE

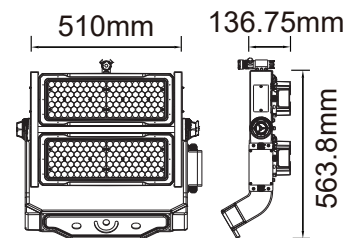

BEAM ANGLE 120°

VT-1003D

SKU: 498 | 4000K DAY WHITE

WATTS	LUMENS	BOX QTY.	WEIGHT
1000w	120000	1 pcs	30.8KG

BEAM ANGLE 60°

VT-1002D

SKU: 499 | 4000K DAY WHITE

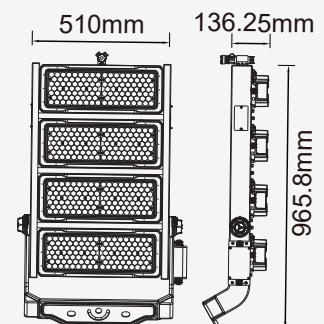



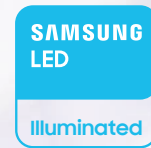

LED STREET LIGHTS

Light the path to a brighter future -- V-TAC's LED street lights are equipped with premium-quality LEDs from Samsung and high performance drivers from DALI, Inventronics, and Mean Well to provide uniform brightness and illumination on highways, streets, tunnels, plazas, industrial facilities, car parks, etc. Includes Class I & Class II Type 3 lenses.

KEY FEATURES

- Modern and efficient replacement for traditional streetlights
- Saves 80% on electricity cost
- Low maintenance; longer lifespan
- Weatherproof body – IP65/66 sealed optical cavities
- Optically optimized glass lenses to prevent eye strains
- Uniformity in light distribution – maximizes efficiency
- Fully operational in extreme weather
- DALI, Inventronics, Mean Well drivers

APPLICATION

Optimized and engineered for streets, public parks, roads & highways, crossroads, tunnels, car parks, industrial facilities, etc.



IP65
RATING

130
LUMENS/WATT

5 YEAR
WARRANTY*

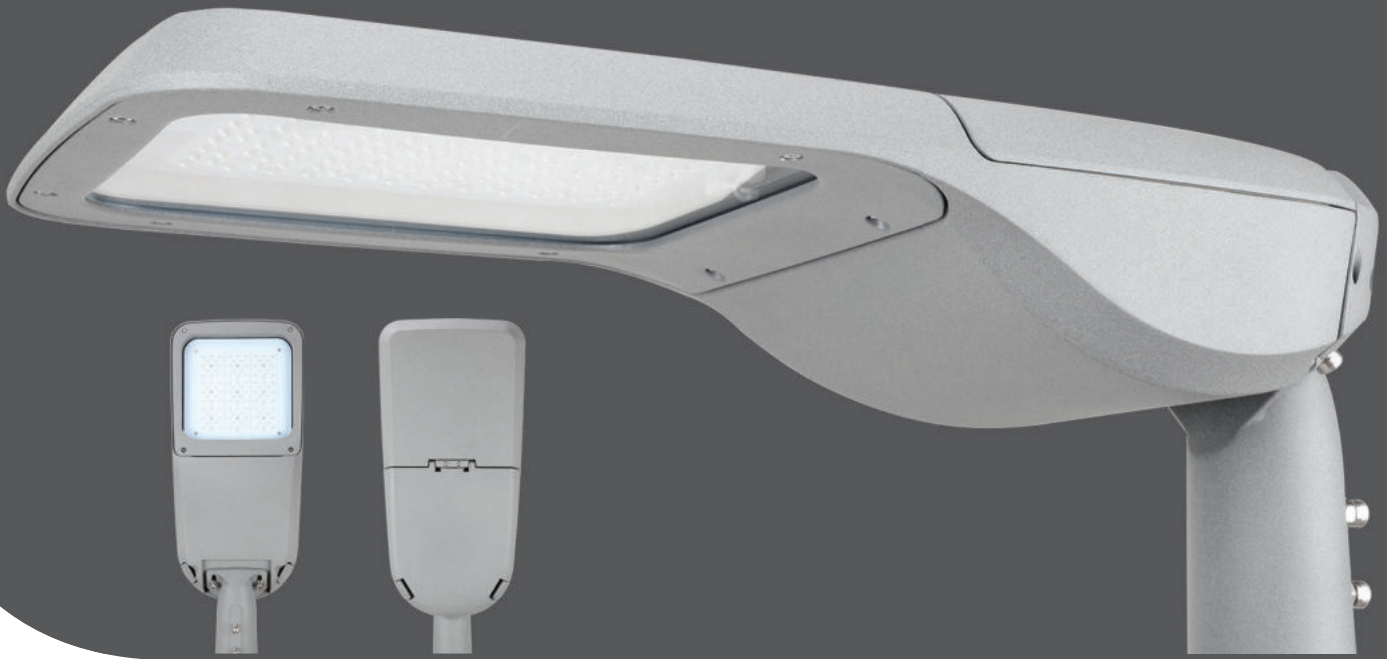

LED STREETLIGHT

CLASS II, TYPE III-M LENS



The new Class II Type III-M lens from V-TAC offers a wide beam angle of 150x80° — especially designed for road lighting in highways, general parking areas, and other spaces where a wide-area lighting is required. Available in 80w to 200w, with select models available with DALI driver.

- **CRI: >70**
- **PF: > 0.9**
- **Up to 26000 lumen output available**
- **AC: 175-265V, 50HZ**
- **IP66 Rating and strong & durable diecast Aluminium body**
- **30,000-hr lifespan**
- **150 x 80° Beam Angle**

VT-80ST

SKU: 541 | 4000K DAY WHITE

WATTS	LUMENS	BOX QTY.
80w	10400	1 pcs

130
Lumen/W

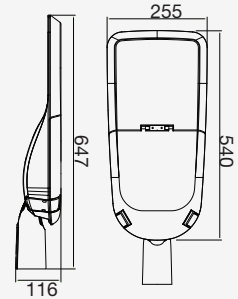

VT-120ST

SKU: 542 | 4000K DAY WHITE

WATTS	LUMENS	BOX QTY.
120w	15600	1 pcs

130
Lumen/W

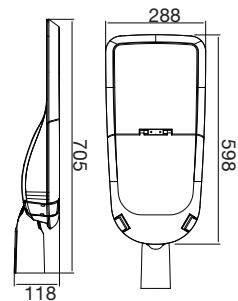

VT-160ST

SKU: 543 | 4000K DAY WHITE

WATTS	LUMENS	BOX QTY.
160w	20800	1 pcs

130
Lumen/W

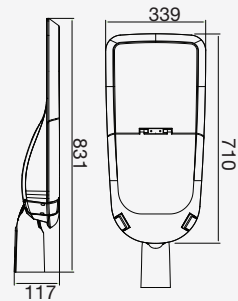

VT-200ST

SKU: 544 | 4000K DAY WHITE

WATTS	LUMENS	BOX QTY.
200w	26000	1 pcs

130
Lumen/W

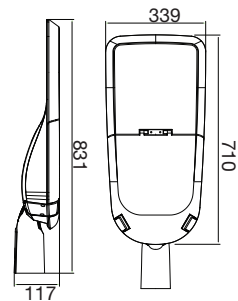



IP65
RATING

130
LUMENS/WATT

5 YEAR
WARRANTY*



LED GARDEN LIGHT

CLASS II, TYPE III-M LENS



The LED Garden Light series offers our high lumen 50W & 100W upright and suspended lighting for outdoor applications. Equipped with high-quality LEDs from Samsung and drivers from Mean Well, these efficient, energy-saving garden lights are a great alternative to traditional street lighting.

- **Instant start: 0-100% in <1sec**
- **On/off cycle: >20,000 times**
- **CRI: >70**
- **PF: > 0.9**
- **IK08 rating**
- **AC: 176-265V, 50HZ**
- **IP65 Rating and strong & durable diecast Aluminium body**
- **30,000-hr lifespan**
- **Beam Angle: 150x80° | 160x100° (Suspended Light)**

Garden Light

VT-55-1

SKU: 782 | 4000K DAY WHITE

WATTS	LUMENS	WEIGHT	BOX QTY.
50w	6500	8.36	1 pcs

130
Lumen/W

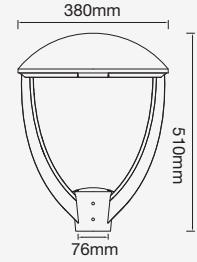

Garden Light

VT-105

SKU: 783 | 4000K DAY WHITE

WATTS	LUMENS	WEIGHT	BOX QTY.
100w	13000	13.28	1 pcs

130
Lumen/W

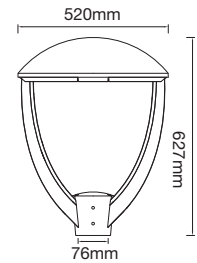

Suspended Light

VT-115ST

SKU: 545 | 4000K DAY WHITE

WATTS	LUMENS	WEIGHT	BOX QTY.
100w	13000	11.16	1 pcs

130
Lumen/W

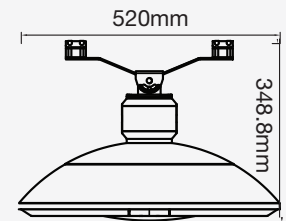

NEW



STREET LIGHT



SUSPENDED



GARDEN LIGHT

CLASS I, TYPE III-M LENS Garden Light

VT-895

SKU: 8679 | 5700K WHITE

WATTS	LUMENS	BOX QTY.
50w	6750	1 pcs

130
Lumen/W

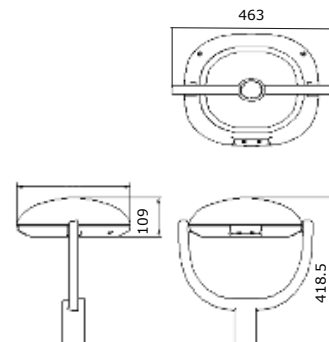



IP65
RATING

140+
LUMENS/WATT

5 YEAR
WARRANTY*

LED STREETLIGHT

Class I, Inventronics Driver Streetlight

The LED Streetlight (Class I Type) offers a high-lumen output and highly efficient performance improved through the industry-leading Inventronics driver. Especially designed for road lighting in highways, general parking areas, and other spaces where a wide-area lighting is required. Available in 50w to 150w.

- **CRI: >70**
- **PF: > 0.9**
- **AC: 90-305V,50Hz**
- **IP65 Rating and strong & durable diecast Aluminium body**
- **30,000-hr lifespan**
- **153x70° Beam Angle**



140
 Lumen/W

VT-53ST

SKU: 953 | 5700K WHITE

WATTS	LUMENS	BOX QTY.
50w	7000	2 pcs

INVENTRONICS
 DRIVER

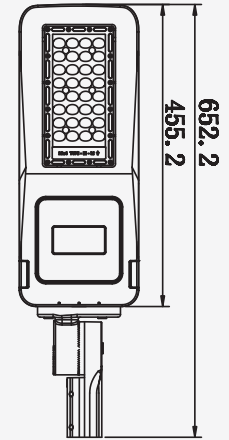

140
 Lumen/W

VT-103ST

SKU: 954 | 5700K WHITE

WATTS	LUMENS	BOX QTY.
100w	14000	2 pcs

INVENTRONICS
 DRIVER

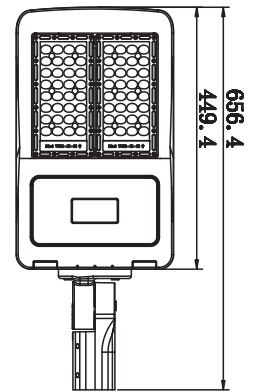

140
 Lumen/W

VT-153ST

SKU: 955 | 5700K WHITE

WATTS	LUMENS	BOX QTY.
150w	21000	1 pcs

INVENTRONICS
 DRIVER

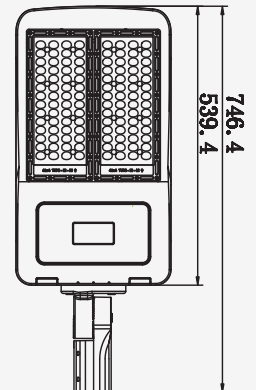



IP65
RATING

140
LUMENS/WATT

5 YEAR
WARRANTY*

LED STREETLIGHT

Available in 100W to 200W, V-TAC's innovative range of streetlights introduces the new dimmable series with LEDs provided by Samsung and world-renowned Inventronics driver. These streetlights are recommendable to help streets easily adapt to the varied night lighting need of different areas or regions which can ultimately lead to even bigger savings in energy consumption.

- **CRI: >70**
- **PF: > 0.9**
- **Up to 28000 lumen output available**
- **AC:200-240V**
- **IP65 Rating and strong & durable diecast Aluminium body**
- **30,000-hr lifespan**
- **153x70° Beam Angle**

VT-102ST

SKU: 883 | 4000K DAY WHITE
SKU: 884 | 5700K WHITE

WATTS	LUMENS	BOX QTY.
100w	14000	1 pcs

INVENTRONICS DRIVER

140
Lumen/W

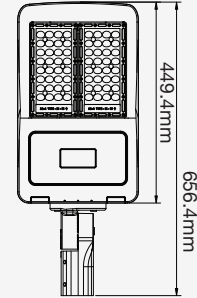

VT-122ST

SKU: 885 | 4000K DAY WHITE
SKU: 886 | 5700K WHITE

WATTS	LUMENS	BOX QTY.
120w	16800	1 pcs

INVENTRONICS DRIVER

140
Lumen/W

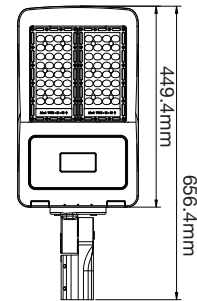

VT-152ST

SKU: 887 | 4000K DAY WHITE
SKU: 888 | 5700K WHITE

WATTS	LUMENS	BOX QTY.
150w	21000	1 pcs

INVENTRONICS DRIVER

140
Lumen/W

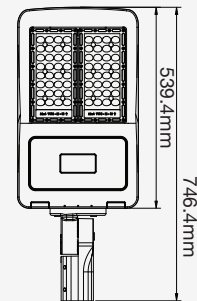

VT-202ST

SKU: 889 | 4000K DAY WHITE
SKU: 890 | 5700K WHITE

WATTS	LUMENS	BOX QTY.
200w	28000	1 pcs

INVENTRONICS DRIVER

140
Lumen/W

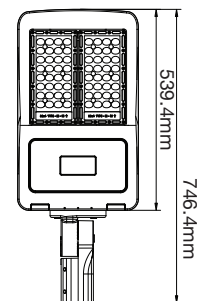



120+
+
LUMENS/WATT

5
YEAR
WARRANTY*

LED STREETLIGHT

Slim Streetlight

The Slim Streetlight series from V-TAC offers a sleeker, leaner design without compromising the high lumen output that V-TAC streetlights are known for. Especially designed for road lighting in highways, general parking areas, and other spaces where a wide-area lighting is required. Available in 30w to 150w.

- **30,000 Life Hours**
- **110° Beam Angle**
- **Material aluminium**
- **Input AC:220-240V,50Hz**
- **CRI >70**
- **PF >0.9**



120
 Lumen/W

VT-34ST

SKU: 956 | 4000K DAY WHITE
 SKU: 957 | 6400K WHITE

WATTS	LUMENS	BOX QTY.
30w	3600	4 pcs

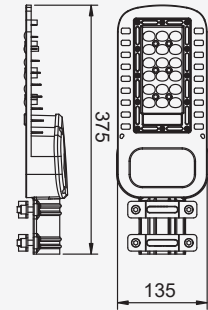

120
 Lumen/W

VT-54ST

SKU: 958 | 4000K DAY WHITE
 SKU: 959 | 6400K WHITE

WATTS	LUMENS	BOX QTY.
50w	6000	4 pcs

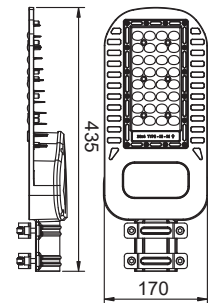

120
 Lumen/W

VT-104ST

SKU: 960 | 4000K DAY WHITE
 SKU: 961 | 6400K WHITE

WATTS	LUMENS	BOX QTY.
100w	12000	2 pcs

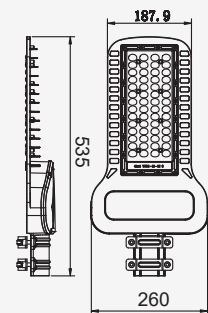

120
 Lumen/W

VT-154ST

SKU: 962 | 4000K DAY WHITE
 SKU: 963 | 6400K WHITE

WATTS	LUMENS	BOX QTY.
150w	18000	2 pcs

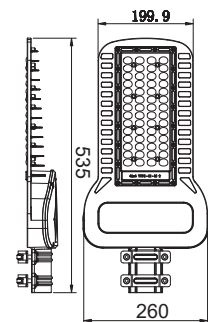



120+
+
LUMENS/WATT

5
YEAR
WARRANTY*

LED STREETLIGHT

Streetlight-Grey

Retaining the classic design of the V-TAC streetlight, the grey streetlight series boasts of high-quality LEDs from Samsung with superb energy efficiency. Available in 30W to 150W, and impressive lumen output of up to 18000.

- 110° Beam Angle
- CRI: >70
- PF: > 0.9
- Up to 18000 lumen output available
- AC: 175-265V,50Hz
- IP65 Rating and strong & durable diecast Aluminium body
- 30,000-hr lifespan

LUMINOUS INTENSITY DISTRIBUTION DIAGRAM

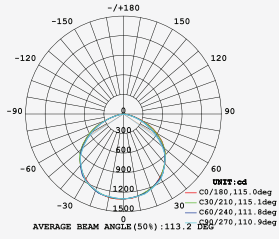

VT-30ST

SKU: 525 | 4000K DAY WHITE
 SKU: 526 | 6400K WHITE

WATTS	LUMENS	BOX QTY.
30w	3600	4 pcs

120
 Lumen/W

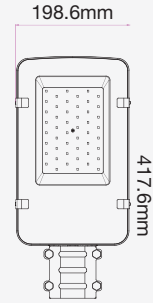

LUMINOUS INTENSITY DISTRIBUTION DIAGRAM

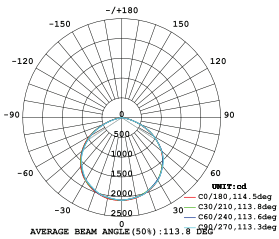

VT-50ST

SKU: 527 | 4000K DAY WHITE
 SKU: 528 | 6400K WHITE

WATTS	LUMENS	BOX QTY.
50w	6000	4 pcs

120
 Lumen/W

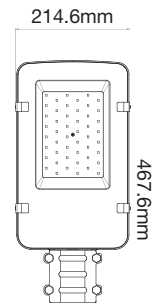

LUMINOUS INTENSITY DISTRIBUTION DIAGRAM

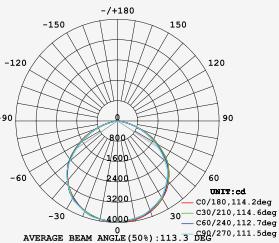

VT-100ST

SKU: 529 | 4000K DAY WHITE
 SKU: 530 | 6400K WHITE

WATTS	LUMENS	BOX QTY.
100w	12000	2 pcs

120
 Lumen/W

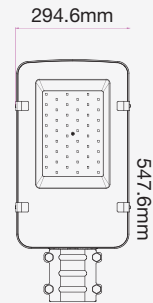

LUMINOUS INTENSITY DISTRIBUTION DIAGRAM

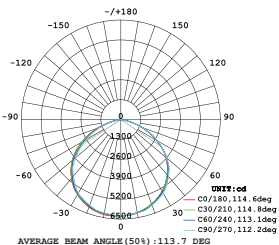

VT-150ST

SKU: 531 | 4000K DAY WHITE
 SKU: 532 | 6400K WHITE

WATTS	LUMENS	BOX QTY.
150w	18000	2 pcs

120
 Lumen/W

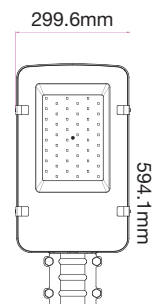

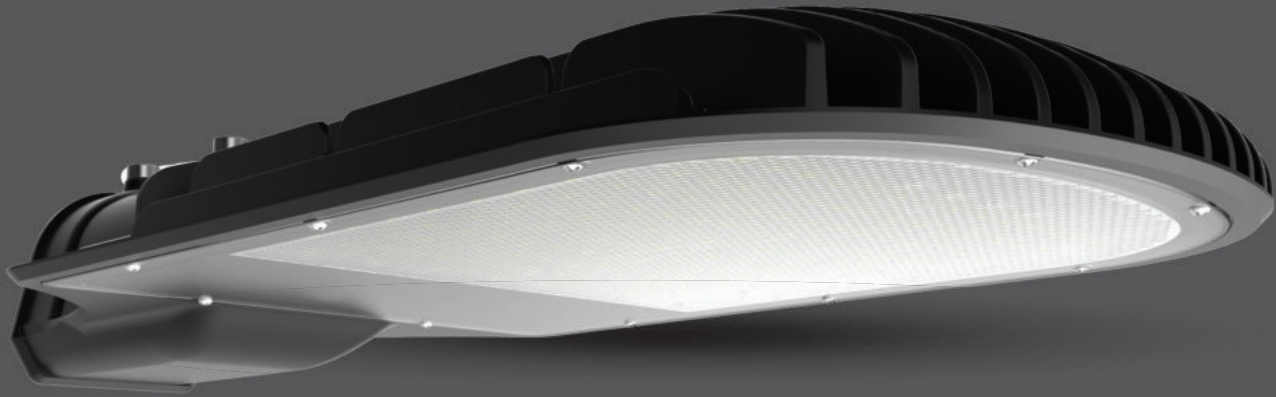

IP65
RATING

3 YEAR
WARRANTY*

LED STREETLIGHT

Retaining the classic design of the V-TAC streetlight in Iron Grey finish, this series boasts of high-quality LEDs from Samsung with superb energy efficiency. Available in 30W to 120W, and impressive lumen output of up to 12000

- **CRI: >70**
- **PF: > 0.9**
- **30,000-hr lifespan**
- **AC:200-240V**
- **IP65 Rating and strong & durable diecast Aluminium body**
- **Beam Angle: 110° | 65x135° (with lens)**

LUMINOUS INTENSITY DISTRIBUTION DIAGRAM

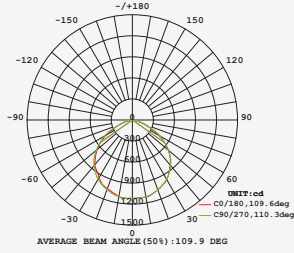

VT-31ST

SKU: 537 | 4000K DAY WHITE

SKU: 538 | 6400K WHITE

WATTS	LUMENS	BOX QTY.
30w	3000	4 pcs

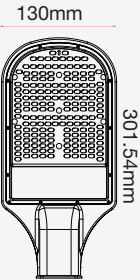

LUMINOUS INTENSITY DISTRIBUTION DIAGRAM

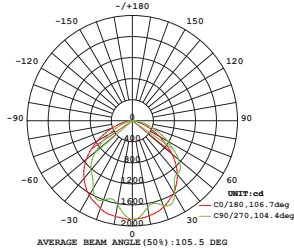

VT-51ST

SKU: 539 | 4000K DAY WHITE

SKU: 540 | 6400K WHITE

WATTS	LUMENS	BOX QTY.
50w	5000	4 pcs

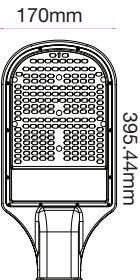

LUMINOUS INTENSITY DISTRIBUTION DIAGRAM

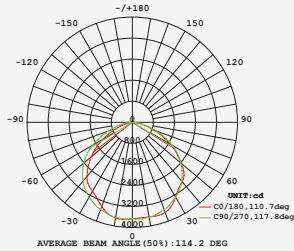

VT-101ST

SKU: 535 | 4000K DAY WHITE

SKU: 536 | 6400K WHITE

WATTS	LUMENS	BOX QTY.
100w	10000	2 pcs

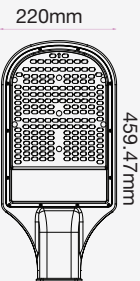

LUMINOUS INTENSITY DISTRIBUTION DIAGRAM

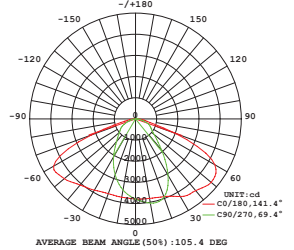

VT-121ST

SKU: 533 | 4000K DAY WHITE

SKU: 534 | 6400K WHITE

WATTS	LUMENS	BOX QTY.
120w	12000	2 pcs

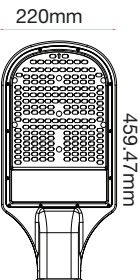

STREETLIGHT-ADAPTER

VT-795

SKU: 3624 3800157608152

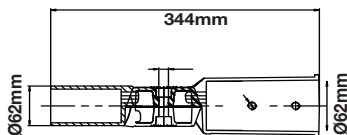

Compatible with 100W, 120W and 150W models, this adapter allows the angle of the streetlight to be adjusted as per client's requirements.



STREETLIGHT-ADAPTER

VT-795-1

SKU: 3668 3800157625029

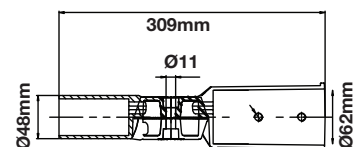

Compatible with 30W and 50W models, this adapter allows the angle of the streetlight to be adjusted as per client's requirements.



LED Highbay

Our world-class highbay range includes models with drivers from Mean Well and Samsung -- both key players in the LED driver market that boasts of exceptional energy-saving features.

With up to a staggering 180++ lumen-per-watt rating and drivers that provide a lifespan of up to 50,000 hours, V-TAC's new generation of LED highbays are the strongest and most efficient LED high bays available in the market today. Available in 100W to 500W.

APPLICATION

Recommended for lighting in warehouses, factories, gymnasiums, or any large open area with high ceiling





KEY FEATURES

- Professional upgraded drivers from Mean Well and Samsung
- Strong and durable diecast aluminum body
- IP65 rating
- SMD LED
- Compatible with Daylight Sensors
- Up to 30,000-hr lifespan
- Available reflectors for a customized beam angle: aluminum & PC transparent



120
LUMENS/WATT

IP65
RATING

USING
SAMSUNG
POWER SUPPLY

Optional
DAYLIGHT SENSOR
SKU - 1369

1-10V
DIMMABLE



REFLECTOR HIGHBAYS

SAMSUNG Power Supply

With our latest in-branding program with Samsung, these highbays offer a high-lumen output of up to 180 lm/w and boasts of efficiency in every lumen with Samsung's cutting edge drivers. With strong, IP65-rated diecast aluminum enclosing and unparalleled lighting performance, these LED highbays are sure to take the industrial lighting market by storm.

- 120 lm/w
- 30,000 hrs Lifespan
- AC:220-240V,50Hz
- PF: >0.9
- CRI:>80
- Die cast Aluminum

5 YEAR
WARRANTY*

MODEL	WATTS	LUMENS	BEAM ANGLE	BOX QTY.
VT-9-113	100w	16000	120°	1 pcs

SKU: 20024 | 4000K DAY WHITE
SKU: 20025 | 6000K WHITE

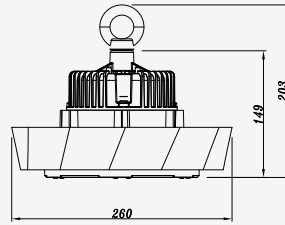

SuperBRIGHT

160

LUMENS/W



MODEL	WATTS	LUMENS	BEAM ANGLE	BOX QTY.
VT-9-108	100w	18000	120°	1 pcs

SKU: 575 | 4000K DAY WHITE
SKU: 576 | 6400K WHITE

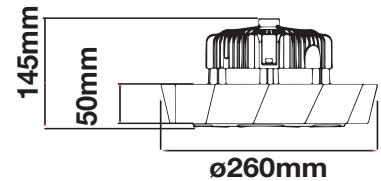

MODEL	WATTS	LUMENS	BEAM ANGLE	BOX QTY.
VT-9-103	100w	12000	120°	1 pcs

SKU: 577 | 4000K DAY WHITE
SKU: 578 | 6400K WHITE

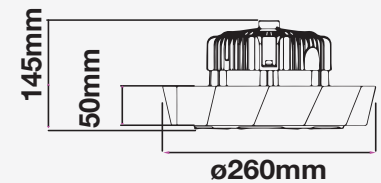

MODEL	WATTS	LUMENS	BEAM ANGLE	BOX QTY.
VT-9-105	100w	12000	90°	1 pcs

SKU: 583 | 4000K DAY WHITE
SKU: 584 | 6400K WHITE

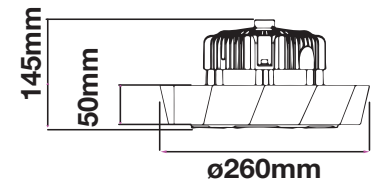

COVER OPTIONS



Aluminum Reflector
90° SKU-570



Aluminum Reflector
120° SKU-571



PC Transparent Reflector
120° SKU-574



PC Dustproof Cover
SKU-586

V-TAC PERFORMANCE
180
LUMENS/WATT

 **IP65**
RATING

MW
MEAN WELL
Your Reliable Power Partner

Optional
DAYLIGHT SENSOR
SKU - 1369

 **1-10V**
DIMMABLE



REFLECTOR HIGHBAYS

MEAN WELL Driver

Powerful performance with ultra-efficient energy management. With a staggering high-lumen rating of 180 lm/w matched with the highly acclaimed Mean Well driver and IP65 Aluminum body, this range of highbays with LEDs provided by Samsung is the optimal choice for heavy-duty industrial lighting in warehouses, factories, and workshops. Perfectly compatible with daylight sensors, Aluminum and PC reflectors are also available for maximum directional customizability.

- **PF: >0.9**
- **CRI:>80**
- **Die cast Aluminum**
- **SMD LED Type**
- **30,000 hrs Lifespan**
- **AC:220-240V,50Hz**

5 YEAR
WARRANTY*

MODEL	WATTS	LUMENS	BEAM ANGLE	BOX QTY.
VT-9-102	100w	18000	120°	2 pcs

SKU: 566 | 4000K DAY WHITE
 SKU: 567 | 6400K WHITE



1-10V
 DIMMABLE

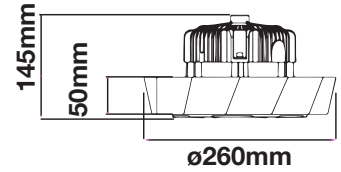

MODEL	WATTS	LUMENS	BEAM ANGLE	BOX QTY.
VT-9-120	120w	21600	120°	2 pcs

SKU: 568 | 4000K DAY WHITE
 SKU: 569 | 6400K WHITE



1-10V
 DIMMABLE

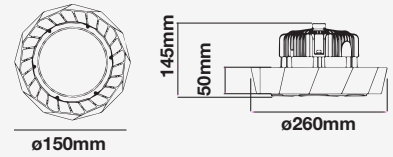

COVER OPTIONS



Aluminum Reflector
 90° SKU-570



Aluminum Reflector
 120° SKU-571



PC Transparent Reflector
 120° SKU-574



PC Dustproof Cover
 SKU-586



120
LUMENS/WATT

IP65
RATING

MW
MEAN WELL
Your Reliable Power Partner

Optional
DAYLIGHT SENSOR
SKU - 1369

1-10V
DIMMABLE



UFO HIGHBAYS

MEAN WELL Driver

This advanced LED highbays are ready to impress with its high-lumen ratings and LED chips from Samsung. This range is equipped with drivers from Mean Well — a key player in the LED driver industry for a strong and efficient performance.

- Available in 100 - 500 watts
- 50,000 hrs Lifespan
- On/Off cycle: >25000
- Instant start: 0-100% in <1s
- AC:95-265V,50/60Hz
- Die cast Aluminum
- PF: >0.9
- CRI:>80

5 YEAR
WARRANTY*

MODEL	WATTS	LUMENS	BEAM ANGLE	BOX QTY.
VT-9-106	100w	12000	120°	1 pcs

SKU: 585 | 4000K DAY WHITE



DALI
 Dimming

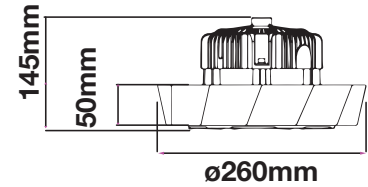

MODEL	WATTS	LUMENS	BEAM ANGLE	BOX QTY.
VT-9-100	100w	12000	90°	4 pcs

SKU: 564 | 4000K DAY WHITE
 SKU: 565 | 6400K WHITE



1-10V
 DIMMABLE

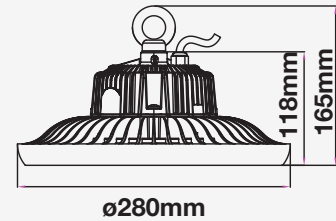

MODEL	WATTS	LUMENS	BEAM ANGLE	BOX QTY.
VT-9-101	100w	12000	120°	4 pcs

SKU: 562 | 4000K DAY WHITE
 SKU: 563 | 6400K WHITE



1-10V
 DIMMABLE

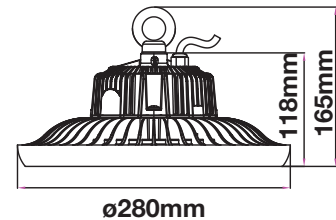

MODEL	WATTS	LUMENS	BEAM ANGLE	BOX QTY.
VT-9-150	150w	18000	90°	2 pcs

SKU: 560 | 4000K DAY WHITE
 SKU: 561 | 6400K WHITE



1-10V
 DIMMABLE

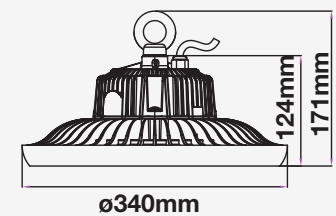

MODEL	WATTS	LUMENS	BEAM ANGLE	BOX QTY.
VT-9-114	100W	12000	120°	1 pcs

SKU: 20063 | 4000K DAY WHITE
 SKU:20064 | 5000K WHITE

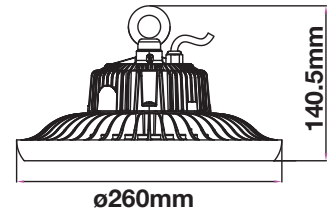

MODEL	WATTS	LUMENS	BEAM ANGLE	BOX QTY.
VT-9-151	150w	18000	120°	2 pcs

SKU: 558 | 4000K DAY WHITE
 SKU: 559 | 6400K WHITE

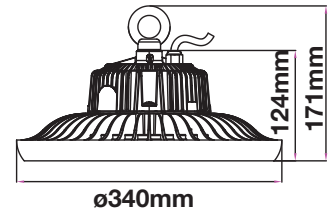

MODEL	WATTS	LUMENS	BEAM ANGLE	BOX QTY.
VT-9-151N	150W	21000	120°	1 pcs

SKU: 55811 | 4000K DAY WHITE
 SKU: 55911 | 6400K WHITE

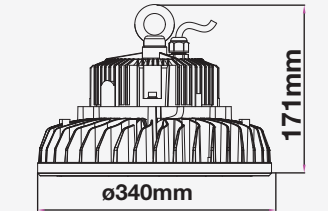

MODEL	WATTS	LUMENS	BEAM ANGLE	BOX QTY.
VT-9-200	200w	24000	120°	1 pcs

SKU: 580 | 4000K DAY WHITE
 SKU: 581 | 6400K WHITE

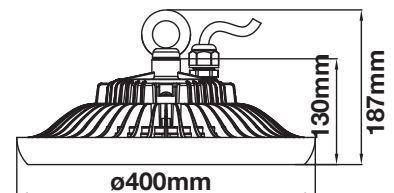

MODEL	WATTS	LUMENS	BEAM ANGLE	BOX QTY.
VT-9-200N	200w	28000	120°	1 pcs

SKU: 58011 | 4000K DAY WHITE
SKU: 58111 | 6400K WHITE

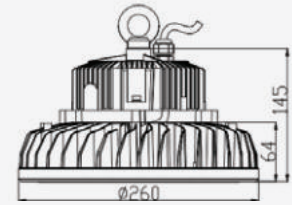

MODEL	WATTS	LUMENS	BEAM ANGLE	BOX QTY.
VT-9-500	500w	60000	120°	1 pcs

SKU: 509 | 4000K DAY WHITE

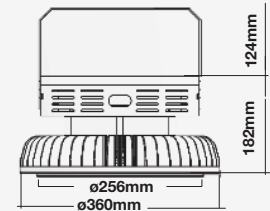

I 40LM/W High Bay Sensor

SKU: 20123



- Rated Voltage: AC:100/277V, 50/60Hz
- Working Mode: On/Off Function, 1-10V step dimming
- IP Rating: IP65
- Hold Time: 5s/30s/1min/3min/5min/10min/20min/30min
- Stand-by Dim Level: 10%/20%/30%/50%
- Stand-by Period: 0s/10s/1min/3min/5min/10min/30min/+∞
- Detection Area: 25%/50%/75%/100%
- Detection Angle: 360°(ceiling mounting)
- Daylight Sensor: 5lux/15lux/30lux/50lux/100lux/150lux/Disable (Ambient light diffusion)
- Compatible with VT-9-151N and VT-9-200N



LED LINEAR LOW BAY

Our series of LED Low Bay fixtures allow parallel lighting on supermarket aisles, workshops, warehouses, and factories which is proven to be approximately 50% more efficient than a perpendicular lighting layout and also decreases eye strain. This range offers strong and ample light with promising 120 lm/w options and impressive energy-saving features compared to its traditional counterparts. Available in 100w to 200w.

- **AC:220-240v,50HZ**
- **On/off: >20,000 times**
- **IP54 rating**
- **Lifespan - 30,000 hrs**
- **Aluminium body**
- **Heat and Shock Resistant.**
- **Low-maintenance**
- **Upgraded with premium-quality Samsung LEDs**
- **Ideal for workshops, supermarkets, warehouses, etc.**
- **High-lumen (120 lm/w) options available**

MODEL	WATTS	LUMENS	BEAM ANGLE	PF	CRI	LED	BODY	BOX QTY.
VT-9-112	100w	12000	120°	>0.9	>80	SMD	Aluminum	6 pcs

SKU: 891 | 4000K DAY WHITE
 SKU: 892 | 6000K WHITE

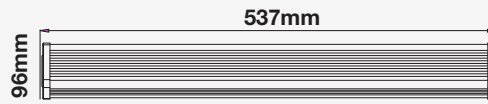

120
 Lumen/W

MODEL	WATTS	LUMENS	BEAM ANGLE	PF	CRI	LED	BODY	BOX QTY.
VT-9-152	150w	18000	120°	>0.9	>80	SMD	Aluminum	6 pcs

SKU: 893 | 4000K DAY WHITE
 SKU: 894 | 6000K WHITE

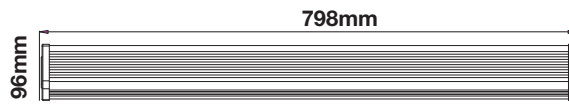

120
 Lumen/W

MODEL	WATTS	LUMENS	BEAM ANGLE	PF	CRI	LED	BODY	BOX QTY.
VT-9-202	200w	24000	120°	>0.9	>80	SMD	Aluminum	6 pcs

SKU: 895 | 4000K DAY WHITE
 SKU: 896 | 6000K WHITE

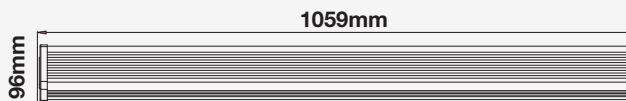

120
 Lumen/W



LED CANOPY LIGHTING

A specialized addition to V-TAC's current roster of innovative LED lighting solutions, the LED canopy light with Samsung LED is precisely designed for petrol stations. It has a slim design that is suitable for recessed or surface-mounted installation. This canopy is aluminum-made, having a tough exterior made to withstand extreme temperature or UV conditions.

- **Specially designed for gas stations**
- **Suitable for recessed or surface mounted installation**
- **Super slim design and nice looking, easier to install**
- **Instant start, no noise, no fl ickering.**
- **Heat and Shock Resistant.**
- **Reduce maintenance costs up to 90%, almost free of maintenance.**
- **Suit for both indoor and outdoor use.**

MODEL	WATTS	LUMENS	BEAM ANGLE	BOX QTY.
VT-9-155	150w	18000	110°	2 pcs

SKU: 572 | 4000K DAY WHITE

SKU: 573 | 6400K WHITE

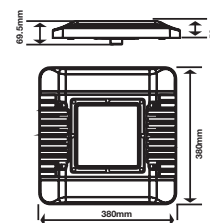



LED PANELS

The PRO Series LED panels range are all made with top-quality PMMA diffusers which provides a uniformly distributed light and prevents the panels from turning yellow.

It proves its durability with exteriors composed of an innovative combination of Aluminum+PMMA+PP, and its energy-saving upgrade through the improved driver box and Samsung LED chip. Both frameless and big panels are inclusive of a quick connector for easy installation.

APPLICATION

Widely used in offices, schools, hospitals, and commercial establishments

V-TAC[®]
INNOVATIVE LED LIGHTING





KEY FEATURES

- Inclusive of a quick connector
- Flicker-free; stable drivers eliminate flashes
- Better light quality: less false colour plots
- 80% lower power consumption than conventional downlights
- Standard dimensions for big panels available
- Choose from square and round frameless mini panels

TP(a) POLYCARBONATE
MICROPRISMATIC DIFFUSER

UGR<19

evolution



QUICK CONNECTOR

LED BIG PANELS

Square Panels-60x60

- Quick Connector
- SMD LED Type
- 30,000 hrs Lifespan
- 120° Beam Angle
- PF:>0.9
- CRI: >80
- Aluminum+ PMMA+PP
- Flicker Free

Our 36w and 45w LED panels are made with high quality PMMA diffusers which prevents it from turning yellow over time and makes it emit strong and evenly distributed light. Also available is the TP(a)-rated panel to meet fire safety standards. All our LED panels have quick connectors that will save installation time and costs.

5 YEAR WARRANTY*

SKU: 20047 | 4000K DAY WHITE
SKU: 20048 | 6400K WHITE

MODEL	WATTS	LUMENS	BOX QTY.
VT-629	29w	3480	6 pcs

AC:200-240V, 50/60Hz

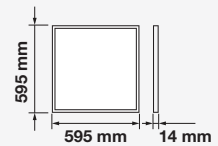

SKU: 750 | 4000K DAY WHITE
SKU: 751 | 6400K WHITE

TP(a) POLYCARBONATE
MICROPRISMATIC DIFFUSER

MODEL	WATTS	LUMENS	BOX QTY.
VT-636	36w	3600	6 pcs

AC:200-240V, 50/60Hz

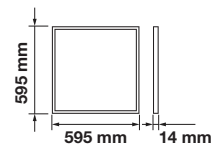

SKU: 632 | 3000K WARM WHITE
SKU: 633 | 4000K DAY WHITE
SKU: 634 | 6400K WHITE

PMMA Diffuser

MODEL	WATTS	LUMENS	BOX QTY.
VT-645	45w	3600	6 pcs

AC:220-240V,50Hz

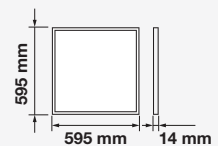

SKU: 20119 | 4000K DAY WHITE

UGR<19

MODEL	WATTS	LUMENS	BOX QTY.
VT-649	45W	3600	6 pcs

AC:200-240V, 50/60Hz

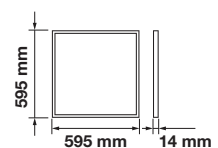



evolution

2.1 IN RECESSED OR SURFACE

SuperBRIGHT
160
LUMENS/W

LED BACKLIT PANEL

Evolution Panels Series

This 25w LED panel delivers 4000 lumens through its impressive 160 lm/w rating. With the flexibility to be installed recessed or surface-mounted, it is sure to be one of the best preferred panels in the market.

- SMD LED Type
- 20,000 hrs Lifespan
- 120° Beam Angle
- AC:200-240V,50/60Hz
- CRI: >80
- FE+PS

SKU: 6600 | 3000K WARM WHITE
SKU: 6601 | 4000K DAY WHITE
SKU: 6602 | 6400K WHITE

MODEL	WATTS	LUMENS	BOX QTY.
VT-6125	25W	4000	1 pcs

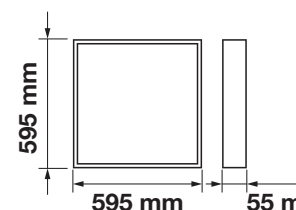

QUICK
CONNECTOR

5 YEAR
WARRANTY*

LED BIG PANELS

Rectangle Panels-120x60

- SMD LED Type
- 20,000 hrs Lifespan
- 120° Beam Angle
- AC:220-240V,50Hz
- CRI: >80
- Aluminum+ PMMA+PP
- Flicker Free

SKU: 748 | 4000K DAY WHITE
SKU: 749 | 6400K WHITE

MODEL	WATTS	LUMENS	BOX QTY.
VT-646	45w	5400	2 pcs

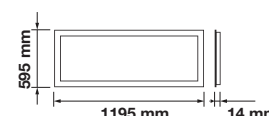

LED MINI PANELS

Round Adjustable Panel

V-TAC's new innovative adjustable mini panels are equipped with adjustable clips for a flexible cutting size of up to 200 mm. Built with the most stable drivers in the market, have low maintenance panels without the flashes and the flickers. These slim & modern panels lights up all the way to the edges, giving a contemporary lighting effect that is ideal for residential, office, or commercial indoor lighting.

- **Adjustable(Cut out) Panel**
- **SMD LED Type**
- **20,000 hrs Lifespan**
- **120° Beam Angle**
- **AC:85-265V,50/60Hz**
- **CRI: >80**
- **Aluminium Body**
- **On/Off Cycle: >15000**

5 YEAR WARRANTY*

SKU: 727 | 3000K WARM WHITE
 SKU: 728 | 4000K DAY WHITE
 SKU: 729 | 6400K WHITE

MODEL	WATTS	LUMENS	BOX QTY.
VT-610RD	12w	750	20 pcs

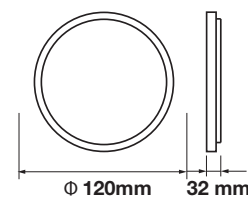

Cutting Size: 75-100mm

SKU: 733 | 3000K WARM WHITE
 SKU: 734 | 4000K DAY WHITE
 SKU: 735 | 6400K WHITE

MODEL	WATTS	LUMENS	BOX QTY.
VT-619RD	18w	1350	20 pcs

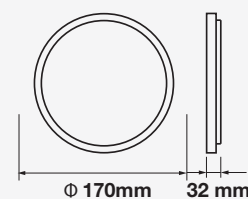

Cutting Size: 75-100mm

SKU: 739 | 3000K WARM WHITE
 SKU: 740 | 4000K DAY WHITE
 SKU: 741 | 6400K WHITE

MODEL	WATTS	LUMENS	BOX QTY.
VT-625RD	24w	1800	20 pcs

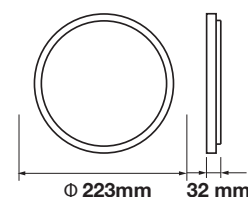

Cutting Size: 75-200mm



LED PANELS

LED MINI PANELS

Square Adjustable Panel

V-TAC's new innovative adjustable mini panels are equipped with adjustable clips for a flexible cutting size of up to 200 mm. Built with the most stable drivers in the market, have low maintenance panels without the flashes and the flickers. These slim & modern panels lights up all the way to the edges, giving a contemporary lighting effect that is ideal for residential, office, or commercial indoor lighting.

- Adjustable(Cut out) Panel
- SMD LED Type
- 20,000 hrs Lifespan
- 120° Beam Angle
- AC:85-265V,50/60Hz
- CRI: >80
- Aluminium Body
- On/Off Cycle: >15000

5 YEAR
WARRANTY*

SKU: 730 | 3000K WARM WHITE
SKU: 731 | 4000K DAY WHITE
SKU: 732 | 6400K WHITE

MODEL	WATTS	LUMENS	BOX QTY.
VT-610SQ	12w	750	20 pcs

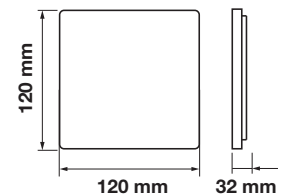

Cutting Size: 75-100mm

SKU: 736 | 3000K WARM WHITE
SKU: 737 | 4000K DAY WHITE
SKU: 738 | 6400K WHITE

MODEL	WATTS	LUMENS	BOX QTY.
VT-619SQ	18w	1350	20 pcs

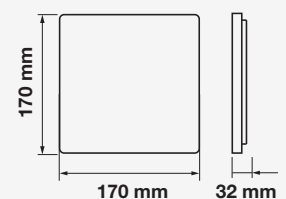

Cutting Size: 75-100mm

SKU: 742 | 3000K WARM WHITE
SKU: 743 | 4000K DAY WHITE
SKU: 744 | 6400K WHITE

MODEL	WATTS	LUMENS	BOX QTY.
VT-625SQ	24w	1800	20 pcs

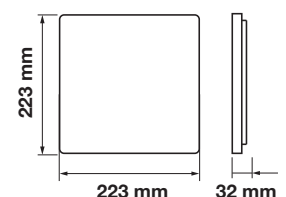

Cutting Size: 75-200mm

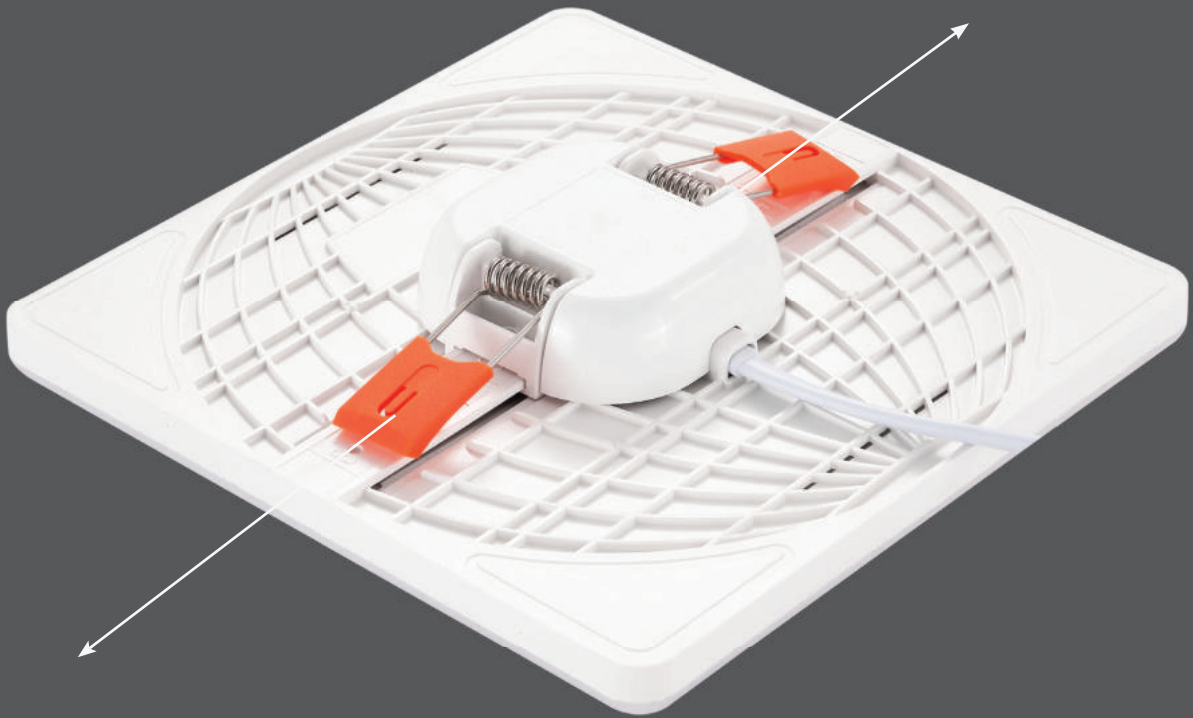

EXPANDABLE CLIPS TO ADJUST

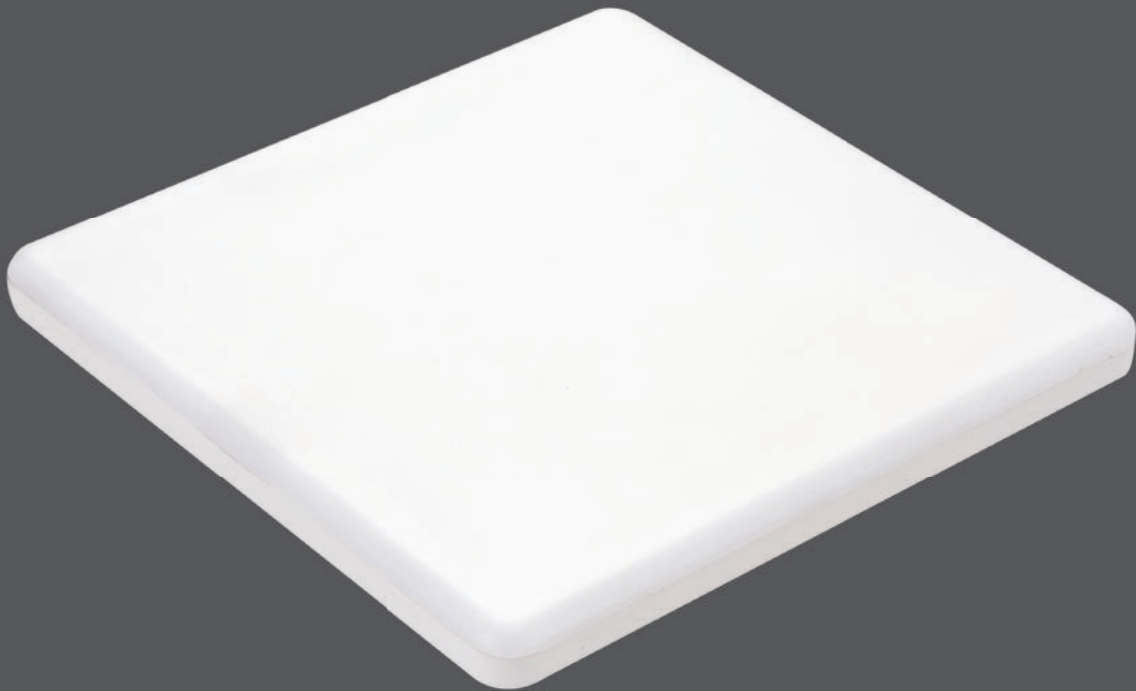

LED MINI PANELS

Round Premium Series Panel

V-TAC's efficient & trendy Premium Series Mini Panels are now upgraded with premium-quality Samsung LED chips for an even better lighting output and performance. Built with the most stable drivers in the market, have low maintenance panels without the flashes and the flickers. These square, slim & modern panels are ideal for residential, office, or commercial indoor lighting.

- **SMD LED Type**
- **30,000 hrs Lifespan**
- **120° Beam Angle**
- **AC:85-265V,50/60Hz**
- **CRI: >80**
- **Aluminium Body**

5 YEAR
WARRANTY*

SKU: 706 | 3000K WARM WHITE
SKU: 707 | 4000K DAY WHITE
SKU: 708 | 6400K WHITE

MODEL	WATTS	LUMENS	BOX QTY.
VT-606RD	6w	420	40 pcs

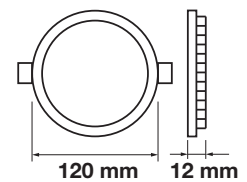

Cutting Size: \varnothing 110mm

SKU: 712 | 3000K WARM WHITE
SKU: 713 | 4000K DAY WHITE
SKU: 714 | 6400K WHITE

MODEL	WATTS	LUMENS	BOX QTY.
VT-612RD	12w	1000	20 pcs

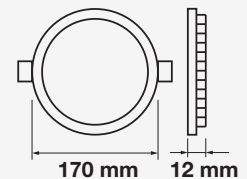

Cutting Size: \varnothing 160mm

SKU: 718 | 3000K WARM WHITE
SKU: 719 | 4000K DAY WHITE
SKU: 720 | 6400K WHITE

MODEL	WATTS	LUMENS	BOX QTY.
VT-618RD	18w	1500	20 pcs

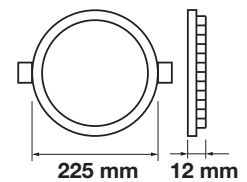

Cutting Size: \varnothing 210mm

SKU: 724 | 3000K WARM WHITE
SKU: 725 | 4000K DAY WHITE
SKU: 726 | 6400K WHITE

MODEL	WATTS	LUMENS	BOX QTY.
VT-624RD	24w	2000	10 pcs

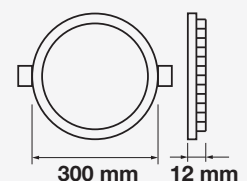

Cutting Size: \varnothing 280mm



LED PANELS

www.v-tac.eu | www.vtacexports.com

LED MINI PANELS

Square Premium Series Panel

V-TAC's efficient & trendy Premium Series Mini Panels are now upgraded with premium-quality Samsung LED chips for an even better lighting output and performance. Built with the most stable drivers in the market, have low maintenance panels without the flashes and the flickers. These square, slim & modern panels are ideal for residential, office, or commercial indoor lighting.

- **SMD LED Type**
- **30,000 hrs Lifespan**
- **120° Beam Angle**
- **AC:85-265V,50/60Hz**
- **CRI: >80**
- **Aluminium Body**

5 YEAR WARRANTY*

SKU: 703 | 3000K WARM WHITE
 SKU: 704 | 4000K DAY WHITE
 SKU: 705 | 6400K WHITE

MODEL	WATTS	LUMENS	BOX QTY.
VT-606SQ	6w	420	40 pcs

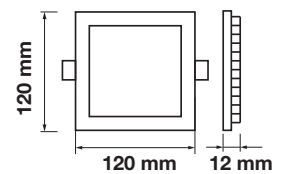

Cutting Size: 110x110mm

SKU: 709 | 3000K WARM WHITE
 SKU: 710 | 4000K DAY WHITE
 SKU: 711 | 6400K WHITE

MODEL	WATTS	LUMENS	BOX QTY.
VT-612SQ	12w	1000	20 pcs

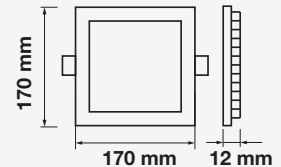

Cutting Size: 160x160mm

SKU: 715 | 3000K WARM WHITE
 SKU: 716 | 4000K DAY WHITE
 SKU: 717 | 6400K WHITE

MODEL	WATTS	LUMENS	BOX QTY.
VT-618SQ	18w	1500	20 pcs

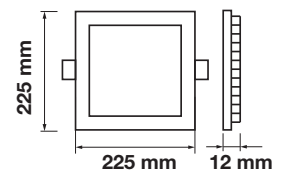

Cutting Size: 210x210mm

SKU: 721 | 3000K WARM WHITE
 SKU: 722 | 4000K DAY WHITE
 SKU: 723 | 6400K WHITE

MODEL	WATTS	LUMENS	BOX QTY.
VT-624SQ	24w	2000	10 pcs

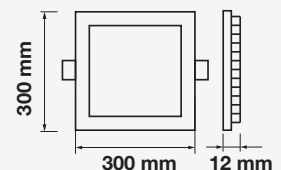

Cutting Size: 280x280mm



LED PANELS

www.v-tac.eu | www.vtacexports.com

LED MINI PANELS

Round Edge Series

V-TAC's Round Edge Panel has an elegant, classic design that lights up all the way to the edges — giving a contemporary lighting effect that is ideal for residential, office, or commercial indoor areas. The quick connector feature lessens set-up time brought by complicated wirings. Built with the most stable drivers in the market, have low maintenance panels without the flashes and the flickers.

- Quick Connector
- SMD LED Type
- 30,000 hrs Lifespan
- 120° Beam Angle
- AC:220-240V,50Hz
- CRI: >80
- ABS+Plastic Body

5 YEAR WARRANTY*

SKU: 628 | 6400K WHITE

MODEL	WATTS	LUMENS	BOX QTY.
VT-608RD	8w	800	100 pcs

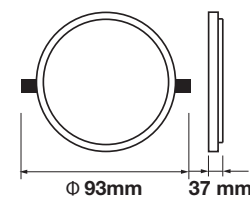

Cutting Size: \varnothing 72 mm

SKU: 621 | 4000K DAY WHITE
SKU: 622 | 6400K WHITE

MODEL	WATTS	LUMENS	BOX QTY.
VT-615RD	15w	1500	40 pcs

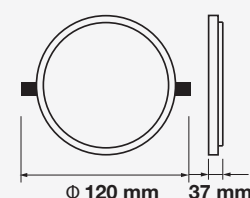

Cutting Size: \varnothing 95 mm

SKU: 614 | 3000K WARM WHITE
SKU: 615 | 4000K DAY WHITE
SKU: 616 | 6400K WHITE

MODEL	WATTS	LUMENS	BOX QTY.
VT-620RD	20w	2000	40 pcs

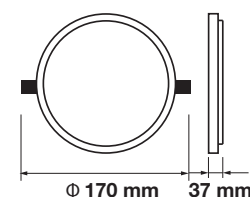

Cutting Size: \varnothing 140 mm

Quick Connector



LED MINI PANELS

Square Edge Series

V-TAC's Round Edge Panel has an elegant, classic design that lights up all the way to the edges — giving a contemporary lighting effect that is ideal for residential, office, or commercial indoor areas. The quick connector feature lessens set-up time brought by complicated wirings. Built with the most stable drivers in the market, have low maintenance panels without the flashes and the flickers.

5 YEAR WARRANTY*

- Quick Connector
- SMD LED Type
- 30,000 hrs Lifespan
- 120° Beam Angle
- AC:220-240V,50Hz
- CRI: >80
- ABS+Plastic Body

SKU: 617 | 3000K WARM WHITE
 SKU: 618 | 4000K DAY WHITE
 SKU: 619 | 6400K WHITE

MODEL	WATTS	LUMENS	BOX QTY.
VT-615SQ	15w	1500	40 pcs

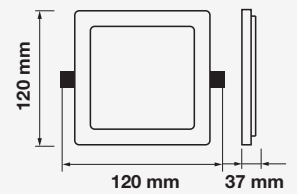

Cutting Size: 95X 95mm

SKU: 611 | 3000K WARM WHITE
 SKU: 612 | 4000K DAY WHITE
 SKU: 613 | 6400K WHITE

MODEL	WATTS	LUMENS	BOX QTY.
VT-620SQ	20w	2000	40 pcs

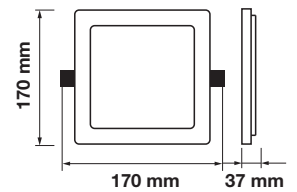

Cutting Size: 142X 142mm

Quick Connector

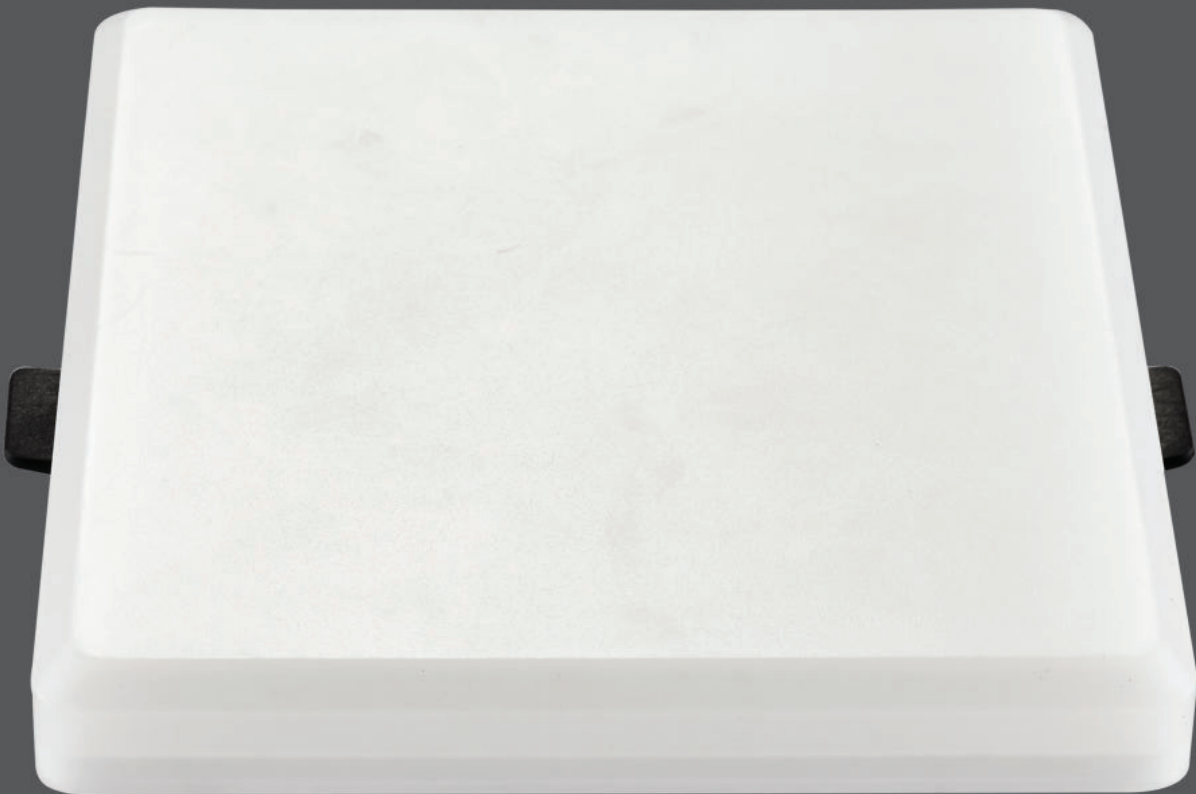
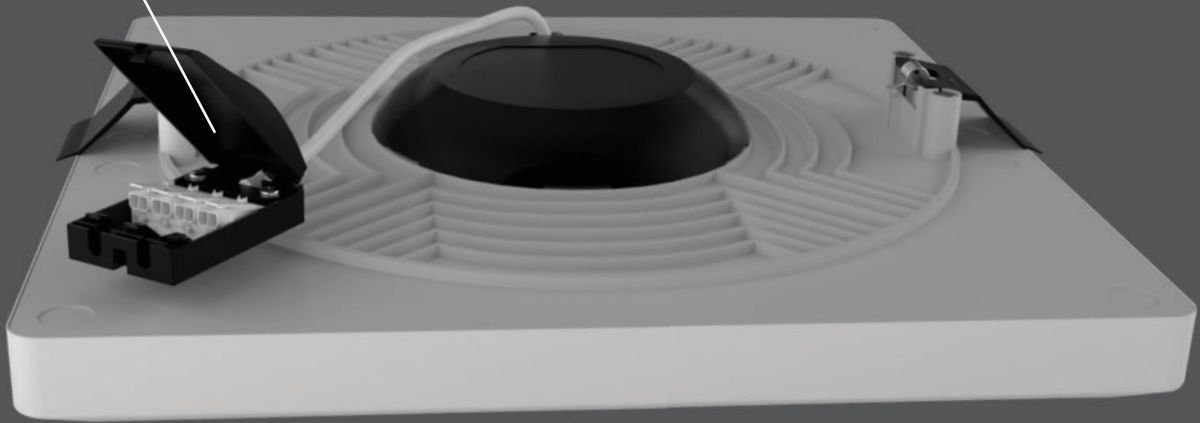



LED TUBES & FIXTURES WITH LED

V-TAC's extensive range of efficient tubes & fixtures boasts of premium quality LED provided by Samsung, a staggering lifespan of up to 30,000 hours, unbreakable body built with the most durable materials in the market, and a wide range of lengths and sizes for different applications.

More innovative additions in this range include

- 1) TP(a) rated fixtures compatible with emergency packs & microwave sensors
- 2) Batten Fittings with CCT-changing Switch
- 3) Linkable T5 Batten Fittings, and more.
- 4) Waterproff Fittings

APPLICATION

Used for general purpose lighting in residences, commercial establishments, supermarkets, and offices

V-TAC[®]
INNOVATIVE LED LIGHTING



KEY FEATURES

- LED provided by Samsung
- Lasts up to 30,000 hrs
- Built with strong, durable materials
- TP(a) Rated fittings for select models
- Programmable DIP Switch Driver for select models
- Emergency Pack & Sensor Compatibility
- Linkable/Continuous T5 fittings
- CCT Changing Switch for select models





Super **BRIGHT**
160
LUMENS/W

T8-NANO PLASTIC TUBES

Evolution Tubes Series

5 YEAR
WARRANTY*

Together with its impressive a++ energy rating, our led tubes offer a staggering 160 lumen per watt output and five years warranty — making it one of the most superior in the competitive led market.

- Nano Plastic
- 30,000 Life Hours
- CRI - >80
- Flicker Free
- PF - 0.9
- On/Off Cycle - >15000 time
- Input Voltage - AC:220-240V,50Hz
- Beam angle:160 °

MODEL	WATTS	LUMENS	WEIGHT-KG	BOX QTY.
VT-1607	7w	1120lm	0.115	25 pcs

SKU: 6474 | 3000K WARM WHITE
 SKU: 6475 | 4000K DAY WHITE
 SKU: 6476 | 6400K WHITE

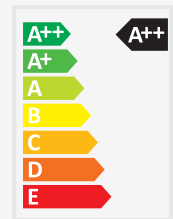
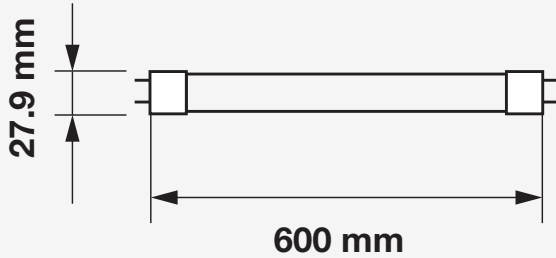

MODEL	WATTS	LUMENS	WEIGHT-KG	BOX QTY.
VT-1612	12w	1920lm	0.193	25 pcs

SKU: 6477 | 3000K WARM WHITE
 SKU: 6478 | 4000K DAY WHITE
 SKU: 6479 | 6400K WHITE

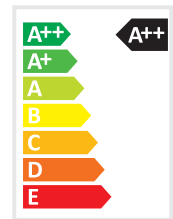
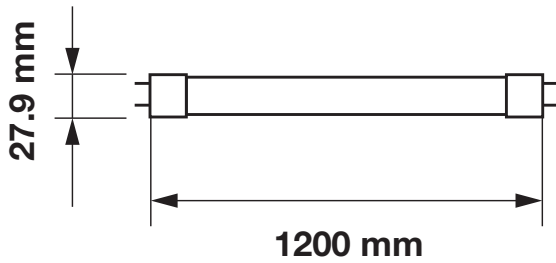

MODEL	WATTS	LUMENS	WEIGHT-KG	BOX QTY.
VT-1615	15w	2400lm	0.261	25 pcs

SKU: 6481 | 4000K DAY WHITE
 SKU: 6482 | 6400K WHITE

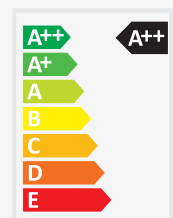
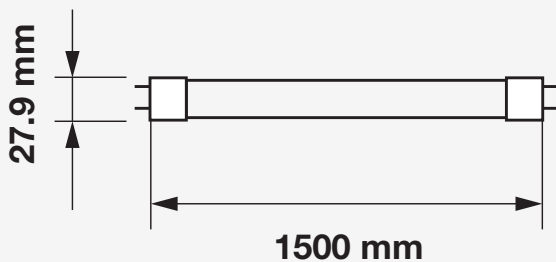



LED TUBES

G13-T8 -Nano Plastic Tube

This modern range of high-lumen LED tubes with Samsung LED chip are the perfect retrofit for fluorescent fixtures. Complete with a series of pop kits (batten fittings inclusive of tubes), these sets of tubes are available in standard lengths for general purpose lighting in residences, commercial establishments, supermarkets, and offices.

- SMD LED Type
- 30,000 hrs Lifespan
- 160° Beam Angle
- 15000 On/Off
- AC:220-240V,50Hz
- >80 CRI
- >0.5 PF
- Nano Plastic Body
- <0.5 s Instant Start

5 YEAR WARRANTY*

MODEL	WATTS	EQ.WATTS	LUMENS	WEIGHT-KG	BOX QTY.
VT-062	10w	18w	1100	0.1264	25 pcs

- SKU: 798 | 3000K WARM WHITE
- SKU: 686 | 4000K DAY WHITE
- SKU: 687 | 6400K WHITE

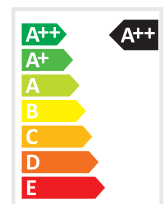
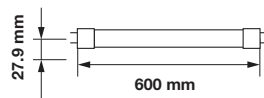

MODEL	WATTS	EQ.WATTS	LUMENS	WEIGHT-KG	BOX QTY.
VT-122	18w	45w	2250	0.1904	25 pcs

- SKU: 688 | 3000K WARM WHITE
- SKU: 672 | 4000K DAY WHITE
- SKU: 673 | 6400K WHITE

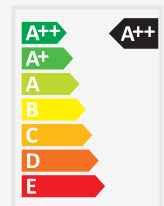
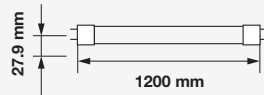

MODEL	WATTS	EQ.WATTS	LUMENS	WEIGHT-KG	BOX QTY.
VT-152	22w	75w	3000	0.2572	25 pcs

- SKU: 799 | 3000K WARM WHITE
- SKU: 674 | 4000K DAY WHITE
- SKU: 675 | 6400K WHITE

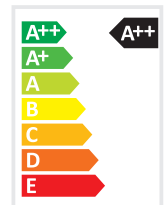
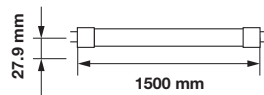

MODEL	WATTS	EQ.WATTS	LUMENS	WEIGHT-KG	BOX QTY.
VT-061	10w	18w	850	0.1264	25 pcs

SKU: 650 | 3000K WARM WHITE
 SKU: 651 | 4000K DAY WHITE
 SKU: 652 | 6400K WHITE

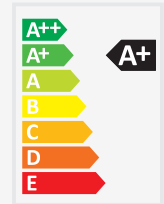
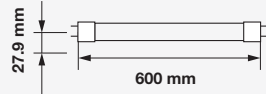

MODEL	WATTS	EQ.WATTS	LUMENS	WEIGHT-KG	BOX QTY.
VT-121	18w	36w	1700	0.1904	25 pcs

SKU: 653 | 3000K WARM WHITE
 SKU: 654 | 4000K DAY WHITE
 SKU: 655 | 6400K WHITE

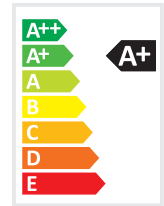
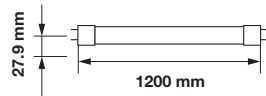

MODEL	WATTS	EQ.WATTS	LUMENS	WEIGHT-KG	BOX QTY.
VT-151	22w	58w	2000	0.2572	25 pcs

SKU: 656 | 3000K WARM WHITE
 SKU: 657 | 4000K DAY WHITE
 SKU: 658 | 6400K WHITE

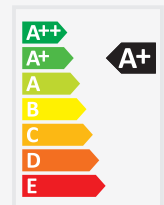
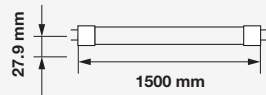

LED BATTEN FITTINGS

Single and Double Batten Fitting

This modern range of batten fittings offer durability and can house one to two LED tubes. These luminaires are available in standard lengths for general purpose lighting in residences, commercial establishments, supermarkets, and offices.

- **SMD LED Type**
- **30,000 hrs Lifespan**
- **160° Beam Angle**
- **AC:220-240V,50Hz**
- **CRI: >80**
- **Nano Plastic Body**

5 YEAR
WARRANTY*



MODEL	WATTS	LUMENS	ON/OFF	PF	BOX QTY.
VT-12026	18w	1700	15000	>0.5	10 pcs

SKU: 6442 | 4000K DAY WHITE



MODEL	WATTS	LUMENS	ON/OFF	PF	BOX QTY.
VT-15023	22w	2000	15000	>0.5	10 pcs

SKU: 6438 | 4000K DAY WHITE





MODEL	WATTS	LUMENS	ON/OFF	PF	BOX QTY.
VT-12027	36w	3400	15000	>0.5	10 pcs

SKU: 6444 | 4000K DAY WHITE



MODEL	WATTS	LUMENS	ON/OFF	PF	BOX QTY.
VT-15024	44w	4000	15000	>0.5	10 pcs

SKU: 6440 | 4000K DAY WHITE

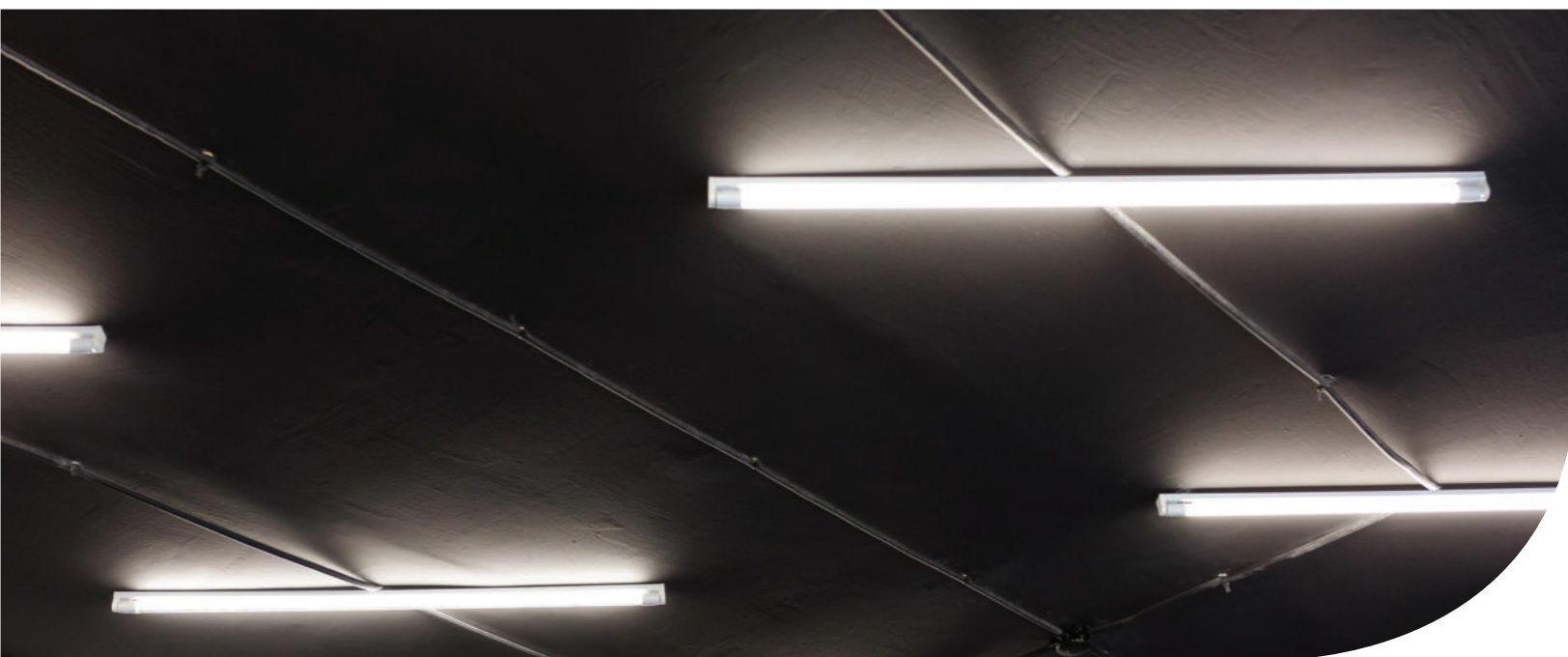



*Super***BRIGHT**
160
LUMENS/W

GRILL FITTING

Evolution Series

5 YEAR
WARRANTY*

Only from v-tac — the first and only led grill fittings with 160 lumens per watt rating from the super bright series offer superior efficiency and great energy savings. Comes with a fast connector for easy wiring and installation.

- **Plastic Body**
- **30,000 Life Hours**
- **CRI - >80**
- **Flicker Free**
- **PF - 0.9**
- **On/Off Cycle - >15000 time**
- **Input Voltage - AC:220-240V,50Hz**
- **Beam angle:160 °**

MODEL	WATTS	LUMENS	WEIGHT-KG	BOX QTY.
VT-8315	15w	2400lm	0.192	30 pcs

SKU: 6487 - 3000K WARM WHITE
 SKU: 6488 - 4000K DAY WHITE
 SKU: 6489 - 6400K WHITE

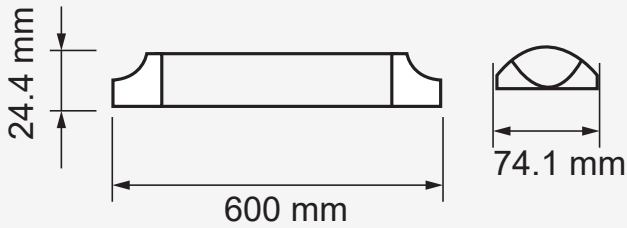

SuperBRIGHT
160
 LUMENS/W



MODEL	WATTS	LUMENS	WEIGHT-KG	BOX QTY.
VT-8330	30w	4800lm	0.35	30 pcs

SKU: 6490 - 3000K WARM WHITE
 SKU: 6491 - 4000K DAY WHITE
 SKU: 6492 - 6400K WHITE

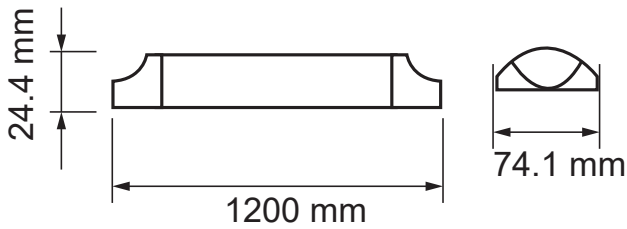

SuperBRIGHT
160
 LUMENS/W



MODEL	WATTS	LUMENS	WEIGHT-KG	BOX QTY.
VT-8338	38w	6080lm	0.57	30 pcs

SKU: 6493 - 3000K WARM WHITE
 SKU: 6494 - 4000K DAY WHITE
 SKU: 6495 - 6400K WHITE

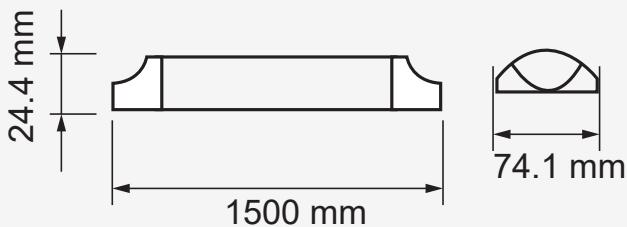

SuperBRIGHT
160
 LUMENS/W





FIXTURES WITH LED

LED Prismatic Fittings

120
 LM/WATT



The reliable 10w to 60w range of efficient LED prismatic fittings from V-TAC all have a high-lumen rating of 120 lm/w and are equipped with quick connectors to lessen set-up time during installation. Available in 3000K, 4000K, and 6400K color temperatures, these durable fittings are ideal for any indoor lighting use

- **SMD LED Type**
- **30,000 hrs Lifespan**
- **110° Beam Angle**
- **15000 On/Off**
- **AC:220-240V,50Hz**
- **CRI: >80**
- **>0.9 PF**
- **Plastic Body**
- **<0.5 s Instant Start**

5 YEAR
 WARRANTY*

MODEL	WATTS	LUMENS	WEIGHT-KG	BOX QTY.
VT-8-10	10w	1200	0.26	10 pcs

SKU: 659 | 3000K WARM WHITE
 SKU: 660 | 4000K DAY WHITE
 SKU: 661 | 6400K WHITE

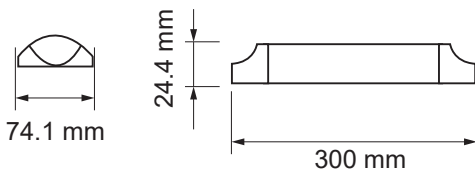

1
 FEET

120
 Lumen/W

MODEL	WATTS	LUMENS	WEIGHT-KG	BOX QTY.
VT-8-20	20w	2400	0.42	10 pcs

SKU: 662 | 3000K WARM WHITE
 SKU: 663 | 4000K DAY WHITE
 SKU: 664 | 6400K WHITE

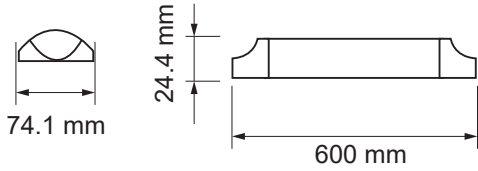

MODEL	WATTS	LUMENS	WEIGHT-KG	BOX QTY.
VT-8-40	40w	4800	0.84	10 pcs

SKU: 665 | 3000K WARM WHITE
 SKU: 666 | 4000K DAY WHITE
 SKU: 667 | 6400K WHITE

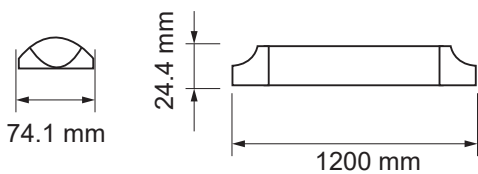

MODEL	WATTS	LUMENS	WEIGHT-KG	BOX QTY.
VT-8-50	50w	6000	1.00	10 pcs

SKU: 668 | 4000K DAY WHITE
 SKU: 669 | 6400K WHITE

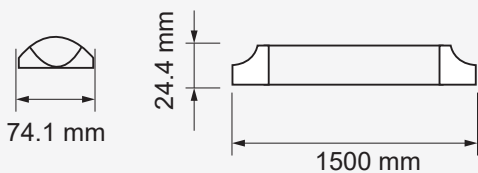

MODEL	WATTS	LUMENS	WEIGHT-KG	BOX QTY.
VT-8-60	60w	7200	1.20	10 pcs

SKU: 670 | 4000K DAY WHITE
 SKU: 671 | 6400K WHITE

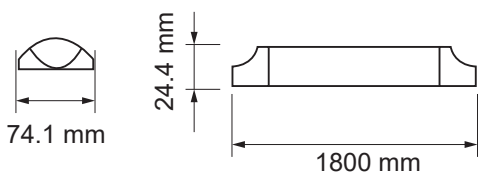

NEW



LED Batten Fitting

- SMD LED Chip
- 30,000 hrs Lifespan
- 120° Beam Angle
- AC:220-240V, 50Hz
- 120LM/W
- CRI >80
- PF >0.9 (Above 24W models)
- Built with safety belt for easy installation
- Instant Start 0-100% in <1s
- On/Off Cycles >15000

5 YEAR
 WARRANTY*



MODEL	WATTS	LUMENS	BOX QTY.
VT-8-24	24w	2880	12 pcs

SKU: 20066 | 4000K DAY WHITE
 SKU: 20067 | 6400K WHITE

120
 Lumen/W

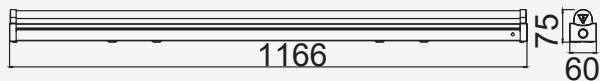

MODEL	WATTS	LUMENS	BOX QTY.
VT-8-28	28w	3360	10 pcs

SKU: 20070 | 4000K DAY WHITE
 SKU: 20071 | 6400K WHITE

120
 Lumen/W

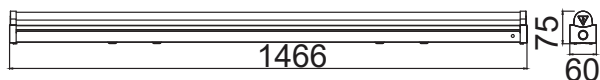

MODEL	WATTS	LUMENS	BOX QTY.
VT-8-44	40w	4800	12 pcs

SKU: 20068 | 4000K DAY WHITE
 SKU: 20069 | 6400K WHITE

120
 Lumen/W

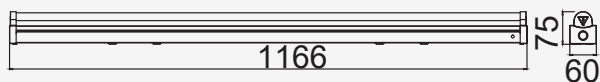

MODEL	WATTS	LUMENS	BOX QTY.
VT-8-54	50w	6000	10 pcs

SKU: 20072 | 4000K DAY WHITE
 SKU: 20073 | 6400K WHITE

120
 Lumen/W

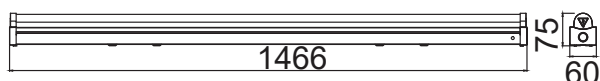

MODEL	WATTS	LUMENS	BOX QTY.
VT-8-64	60w	7200	8 pcs

SKU: 20074 | 4000K DAY WHITE
 SKU: 20075 | 6400K WHITE

120
 Lumen/W

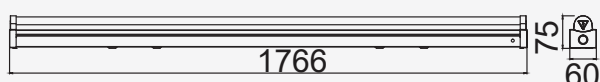



TP(a)

Polycarbonate



Compatible Emergency Pack



Sensor Compatible

FIXTURES WITH LED

LED Batten Fitting



V-TAC's all new range of LED Batten Fittings designed with LED chip by Samsung deliver high performance light output. These fittings are built strong using the materials Iron + Polycarbonate and are also TP(a) rated to meet the fire safety standards. Optional microwave sensor specially designed for LED Batten Fittings is also available.

- **TP(A) Rated**
- **30,000 Life Hours**
- **CRI - >80**
- **PF - 0.9**
- **On/Off Cycle - >15000 time**
- **Input Voltage - AC:220-240V,50Hz**
- **Programmable DIP Switch Driver**

MODEL	WATTS	LUMENS	WEIGHT-KG	BOX QTY.
VT-8-80	80w	8600	2.07	10 pcs

SKU: 757 | 4000K DAY WHITE

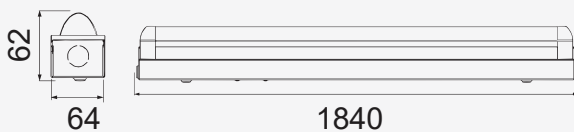

Microwave Sensor (Optional)

Compatible with Batten

VT-8-6 SKU: 759

Detection area:
 4M (@3M MOUNTING HEIGHT)

Detection angle:
 150°(WALL) 360°(CEILING)

Hold time:
 5S / 30S / 90S / 3MIN / 30MIN





LINKABLE
UP TO 100 WATTS TOGETHER

FIXTURES WITH LED

T5 Batten Fitting

5 YEAR
WARRANTY*

The new T5 Batten Fittings retain the premium qualities of V-TAC's fixtures with LED. Each fitting is fully compatible & linkable; multiple batten fittings can be connected with each other, making it an efficient alternative lighting fixture for both small and big indoor spaces.

- **30,000 Life Hours**
- **On/Off switch**
- **On/Off Cycle - >15000 time**
- **Body:PC**
- **Input Voltage - AC:220-240V**
- **CRI - >80**
- **Instant start -0-100% in <1 sec**
- **Beam angle:120 °**

MODEL	WATTS	LUMENS	WEIGHT-KG	BOX QTY.
VT-035	4w	360	0.065	25 pcs

SKU: 689 | 3000K WARM WHITE
 SKU: 690 | 4000K DAY WHITE
 SKU: 691 | 6400K WHITE

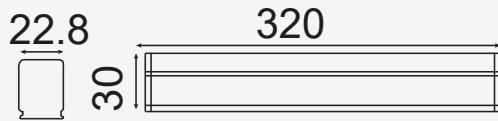

MODEL	WATTS	LUMENS	WEIGHT-KG	BOX QTY.
VT-065	7w	630	0.112	25 pcs

SKU: 692 | 3000K WARM WHITE
 SKU: 693 | 4000K DAY WHITE
 SKU: 694 | 6400K WHITE

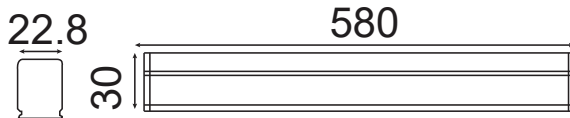

MODEL	WATTS	LUMENS	WEIGHT-KG	BOX QTY.
VT-125	16w	1440	0.16	25 pcs

SKU: 695 | 3000K WARM WHITE
 SKU: 696 | 4000K DAY WHITE
 SKU: 697 | 6400K WHITE

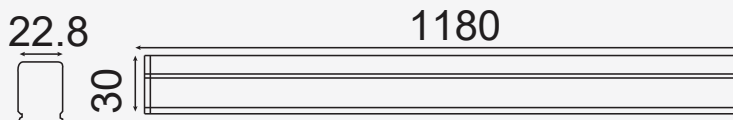

EASY TOGGLE SWITCH



3000K 4000K 6400K

EASY ACCESS FOR
 COLOR CHANGING
 WITH BUTTON

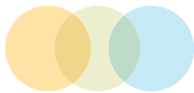

FIXTURES WITH LED

LED Batten Fitting

The new Batten Fittings series from V-TAC boasts of its colour tuning feature with an easy-to-access, built-in switch — enabling users to gradually customise the light from a warm 3000-kelvin white light up to the standard 6400-kelvin white. Choose and switch to your preferred colour temperature anytime.

- **PC+Aluminium+Steel**
- **30,000 Life Hours**
- **CRI - >80**
- **Flicker Free**
- **PF - 0.9**
- **On/Off Cycle - >20000 time**
- **Input Voltage - AC:220-240V,50Hz**
- **Beam angle:120 °**

5 YEAR
WARRANTY*

MODEL	WATTS	LUMENS	WEIGHT-KG	BOX QTY.	SKU: 517 3IN1
VT-8-43	40w	4000	1.68	10 pcs	

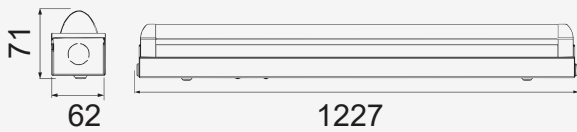

MODEL	WATTS	LUMENS	WEIGHT-KG	BOX QTY.	SKU: 519 3IN1
VT-8-63	60w	6000	2.42	10 pcs	

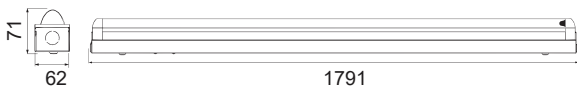



TP(a)

Polycarbonate



Sensor Compatible



FLICKER FREE

FIXTURES WITH LED

LED Batten Fitting

V-TAC's all new range of LED Batten fittings designed with LED chip by Samsung deliver high performance light output of 120 lumens/watt. These fittings are built strong using the materials Iron + Polycarbonate and are also TP(a) rated to meet the fire safety standards. Optional emergency pack and microwave sensor specially designed for LED Batten are also available.

- **TP(A) Rated**
- **30,000 Life Hours**
- **CRI - >80**
- **PF - 0.9**
- **On/Off Cycle - >15000 time**
- **Input Voltage - AC:220-240V,50Hz**
- **Programmable DIP Switch Driver(Applicable for 60W only)**

5 YEAR
WARRANTY*

MODEL	WATTS	LUMENS	WEIGHT-KG	BOX QTY.
VT-8-41	40w	4800	2.90	4 pcs

SKU: 753 | 4000K DAY WHITE

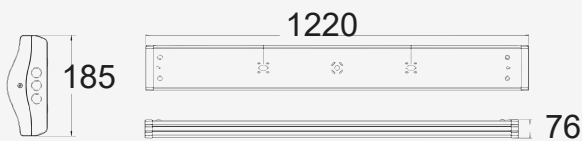

MODEL	WATTS	LUMENS	WEIGHT-KG	BOX QTY.
VT-8-61	60w	7200	3.65	4 pcs

SKU: 754 | 4000K DAY WHITE

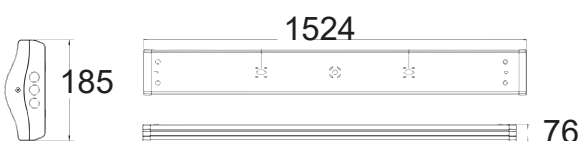



Super **BRIGHT**
160
LUMENS/W



Waterproof Fittings

MODEL	WATTS	LUMENS	ON/OFF	BODY TYPE	PF	WEIGHT-KG	BOX QTY.
VT-1524	24w	3840	15000	PC+ABS	>0.9	0.60 kg	12 pcs

SKU: 6485 - 4500K DAY WHITE
 SKU: 6486 - 6400K WHITE

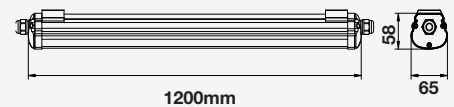

MODEL	WATTS	LUMENS	ON/OFF	BODY TYPE	PF	WEIGHT-KG	BOX QTY.
VT-1532	32w	5120	15000	PC+ABS	>0.9	1.1 kg	12 pcs

SKU: 6483 - 4500K DAY WHITE
 SKU: 6484 - 6400K WHITE

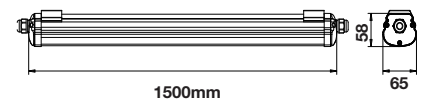



Waterproof Fittings

MODEL	WATTS	LUMENS	ON/OFF	BODY TYPE	PF	WEIGHT-KG	BOX QTY.
VT-180	60w	5400	15000	Plastic + ABS	>0.9	1.30	9 pcs

SKU: 680 | 4000K DAY WHITE
SKU: 681 | 6400K WHITE

5 YEAR
WARRANTY

6
FEET

IP65
RATING

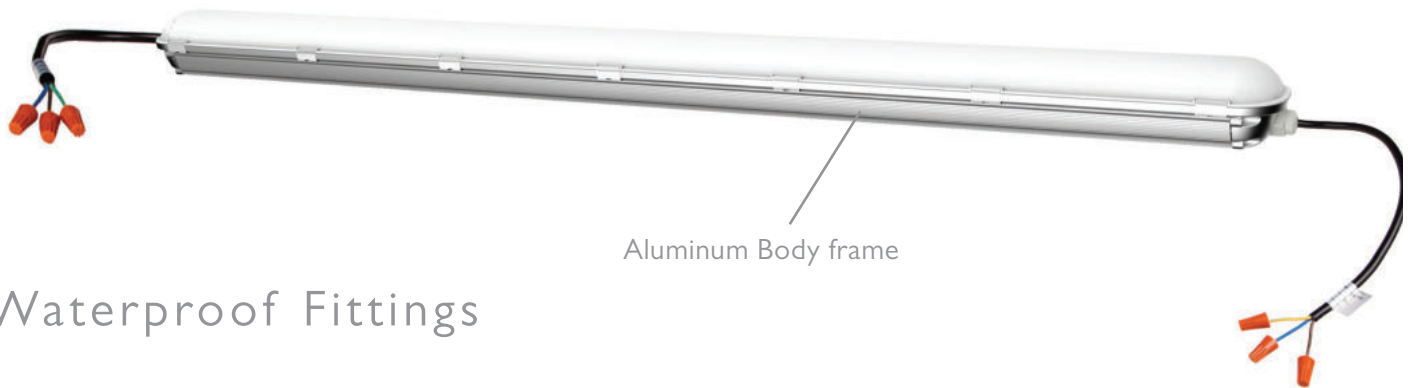
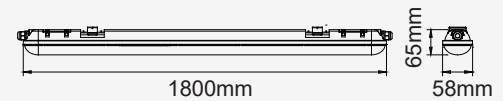

Aluminum Body frame

Waterproof Fittings

MODEL	WATTS	LUMENS	ON/OFF	BODY TYPE	PF	WEIGHT-KG	BOX QTY.
VT-160	60w	7200	15000	Plastic+Aluminium	>0.9	2.10	9 pcs

SKU: 678 | 4000K DAY WHITE
SKU: 679 | 6400K WHITE

5 YEAR
WARRANTY

4
FEET

IP65
RATING

120
Lumen/W

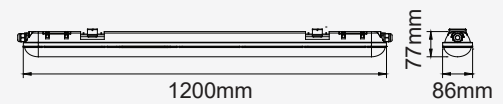

MODEL	WATTS	LUMENS	ON/OFF	BODY TYPE	PF	WEIGHT-KG	BOX QTY.
VT-170	70w	8400	15000	Plastic+Aluminium	>0.9	2.67	9 pcs

SKU: 676 | 4000K DAY WHITE
SKU: 677 | 6400K WHITE

5 YEAR
WARRANTY

5
FEET

IP65
RATING

120
Lumen/W

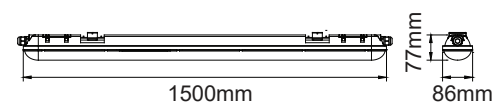

NEW



WATERPROOF FITTINGS

Transparent Cover - M Series

Promoting efficiency with its high-lumen (120 lm/W) rating, this new addition to V-TAC's fixtures range. The transparent cover allows a brighter, well-distributed light that is perfect for task lighting.

- SMD LED Chip
- 20,000 hrs Lifespan
- 120° Beam Angle
- AC:200-240V,50/60Hz
- On/Off Cycles >15000
- CRI >80
- PF >0.9
- IP65
- Body Type: ABS+PC

MODEL:	WATTS	LUMENS	WEIGHT-KG	BOX QTY.	SKU: 20209 4000K DAY WHITE SKU: 20208 6400K WHITE
VT-60018-T	18w	2160	0.68	12 pcs	

3 YEAR WARRANTY
2 FEET
IP65 RATING
120 Lumen/W

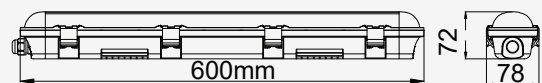

MODEL:	WATTS	LUMENS	WEIGHT-KG	BOX QTY.	SKU: 20205 4000K DAY WHITE SKU: 20204 6400K WHITE
VT-120036-T	36w	4320	1.165	12 pcs	

3 YEAR WARRANTY
4 FEET
IP65 RATING
120 Lumen/W

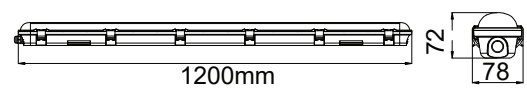

MODEL:	WATTS	LUMENS	WEIGHT-KG	BOX QTY.	SKU: 20201 4000K DAY WHITE SKU: 20200 6400K WHITE
VT-150048-T	48w	5760	1.455	12 pcs	

3 YEAR WARRANTY
5 FEET
IP65 RATING
120 Lumen/W

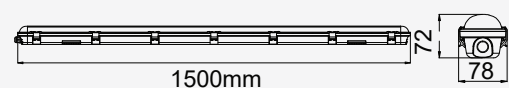

NEW



WATERPROOF FITTINGS

Milky Cover - M Series

Promoting efficiency with its high-lumen (120 lm/W) rating, this new addition to V-TAC's fixtures range. The opaque, milky cover allows for a softer, well-diffused light that is milder to the eyes.

- SMD LED Chip
- 20,000 hrs Lifespan
- 120° Beam Angle
- AC:200-240V,50/60Hz
- On/Off Cycles >15000
- CRI >80
- PF >0.9
- IP65
- Body Type: ABS+PC

MODEL:	WATTS	LUMENS	WEIGHT-KG	BOX QTY.	SKU: 20211 4000K DAY WHITE SKU: 20210 6400K WHITE
VT-60018-M	18w	2160	0.69	12 pcs	

3 YEAR WARRANTY
2 FEET
IP65 RATING
120 Lumen/W

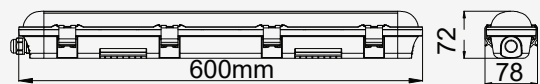

MODEL:	WATTS	LUMENS	WEIGHT-KG	BOX QTY.	SKU: 20207 4000K DAY WHITE SKU: 20206 6400K WHITE
VT-120036-M	36w	4320	1.18	12 pcs	

3 YEAR WARRANTY
4 FEET
IP65 RATING
120 Lumen/W

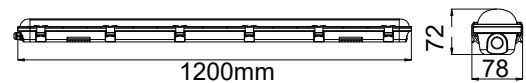

MODEL:	WATTS	LUMENS	WEIGHT-KG	BOX QTY.	SKU: 20203 4000K DAY WHITE SKU: 20202 6400K WHITE
VT-150048-M	48w	5760	1.475	12 pcs	

3 YEAR WARRANTY
5 FEET
IP65 RATING
120 Lumen/W

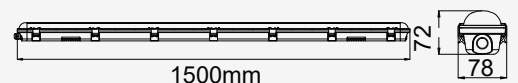

NEW

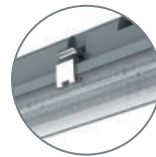
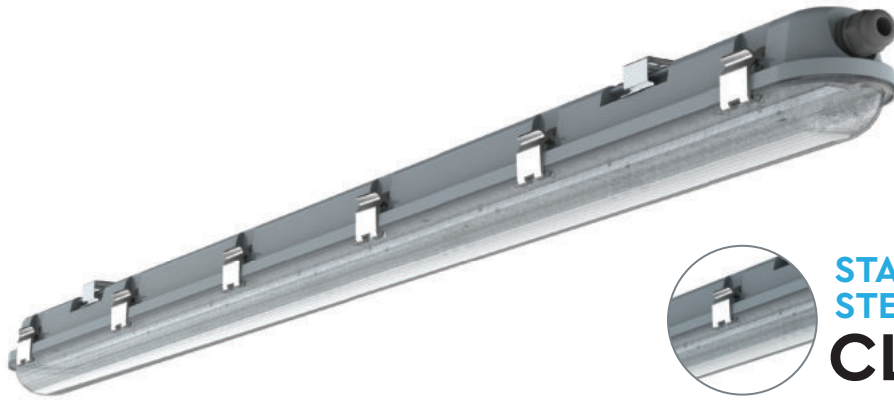

STAINLESS
STEEL
CLIPS

WATERPROOF FITTINGS

Transparent Cover - M Series SS Clips

Promoting efficiency with its high-lumen (120 lm/W) rating, this new addition to V-TAC's fixtures range is reinforced with secure, stainless steel clips for easier maintenance. The transparent cover allows a brighter, well-distributed light that is perfect for task lighting.

- **SMD LED Chip**
- **20,000 hrs Lifespan**
- **120° Beam Angle**
- **AC:200-240V,50/60Hz**
- **On/Off Cycles >15000**
- **Body Type: PC**
- **CRI >80**
- **PF >0.9**
- **IP65**
- **SS Clips**



MODEL:	WATTS	LUMENS	WEIGHT-KG	BOX QTY.	SKU: 20219 4000K DAY WHITE SKU: 20218 6400K WHITE
VT-120136-T	36w	4320	1.238	12 pcs	

3
 YEAR
 WARRANTY

4
 FEET

IP65
 RATING

120
 Lumen/W



MODEL:	WATTS	LUMENS	WEIGHT-KG	BOX QTY.	SKU: 20213 4000K DAY WHITE SKU: 20212 6400K WHITE
VT-150148-T	48w	5760	1.542	12 pcs	

3
 YEAR
 WARRANTY

5
 FEET

IP65
 RATING

120
 Lumen/W

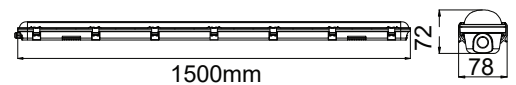

NEW



STAINLESS
STEEL
CLIPS

WATERPROOF FITTINGS

Milky Cover - M Series SS Clips

Promoting efficiency with its high-lumen (120 lm/W) rating, this new addition to V-TAC's fixtures range is reinforced with secure, stainless steel clips for easier maintenance. The opaque, milky cover allows for a softer, well-diffused light that is milder to the eyes.

- SMD LED Chip
- 20,000 hrs Lifespan
- 120° Beam Angle
- AC:200-240V,50/60Hz
- On/Off Cycles >15000
- Body Type: PC
- CRI >80
- PF >0.9
- IP65
- SS Clips



MODEL:	WATTS	LUMENS	WEIGHT-KG	BOX QTY.	SKU: 20217 4000K DAY WHITE SKU: 20216 6400K WHITE
VT-120136-M	36w	4320	1.27	12 pcs	

3
YEAR
WARRANTY

4
FEET

IP65
RATING

120
Lumen/W

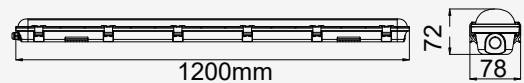

MODEL:	WATTS	LUMENS	WEIGHT-KG	BOX QTY.	SKU: 20215 4000K DAY WHITE SKU: 20214 6400K WHITE
VT-150148-M	48w	5760	1.58	12 pcs	

3
YEAR
WARRANTY

5
FEET

IP65
RATING

120
Lumen/W

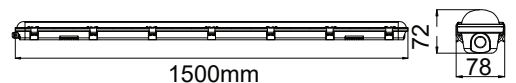



Emergency Pack

SKU: 8343

- **Input Voltage: AC:220-240V,50/60Hz**
- **Charging Time: 24 Hours**
- **Emergency Power: 6-7W**
- **Emergency Operation time: 3 Hours**
- **Battery Type: Ni-Cd 9.6V 2200mAh**
- **Size: 212x40x30mm**
- **Compatible with V-TAC's LED Waterproof Fitting - M Series SS Clips**

Microwave Sensor

SKU: 6622



- **Automatic On/Off control with daylight sensor.**
- **Rod antenna - DIP Switch**
- **Optional detection range, hold time and daylight threshold.**
- **Loop in and loop out for easy installation.**
- **Operating Voltage: AC:220-240V, 50/60Hz**
- **Max Watts: 100W**
- **Hold Time: 5s/1min/3min/10min**
- **Daylight threshold: 30Lux/Disable**
- **Detection Area: 50%/100%**
- **Detection Range: ø4-10m/13.12-32.8ft (ceiling mounted)**
- **Compatible with V-TAC's LED Waterproof Fitting - M Series SS Clips**

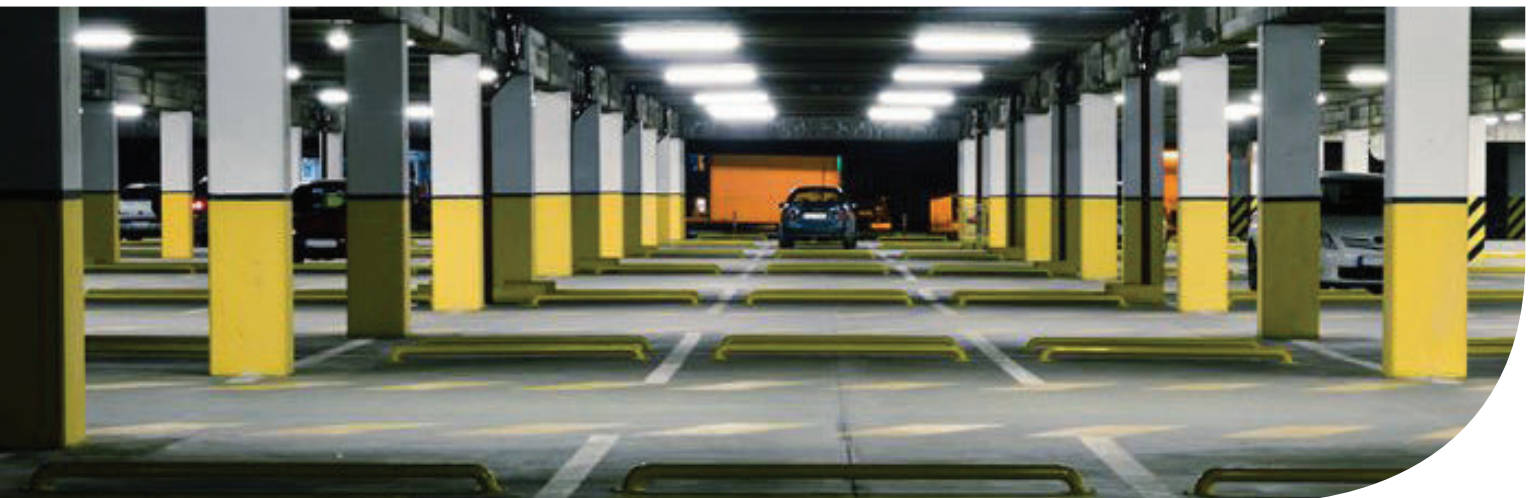



**Emergency
Battery Backup**

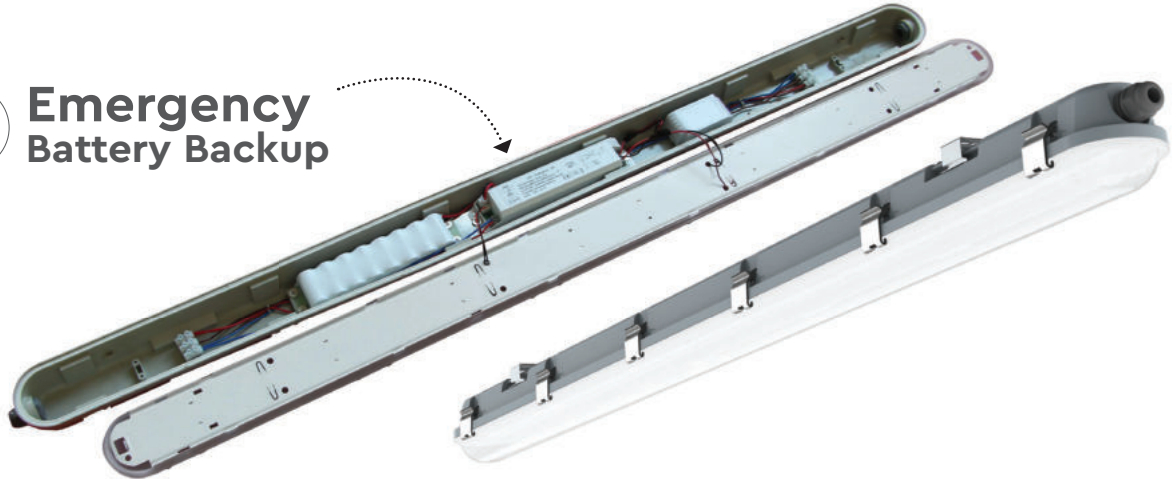

EMERGENCY WATERPROOF FITTINGS

Milky Cover - M Series SS Clips

This model has a built-in battery backup, high-lumen LEDs, and a Milky cover to ensure safety on emergency situations through proper lighting. Durable, IP65-rated PC body for a long-lasting waterproof & dustproof performance both indoors and outdoors.

- 20,000 hrs Lifespan
- 120° Beam Angle
- AC:200-240V,50/60Hz
- Battery Type:9.6V 2200mAh Ni-Cd battery
- Charging Time:24Hours
- Working Time:3Hours
- Emergency Power: 6-7W
- SMD LED Chip
- Body Type: PC
- On/Off Cycles >15000
- CRI >80
- PF >0.9
- IP65
- SS Clips



**STAINLESS
STEEL
CLIPS**



MODEL:	WATTS	LUMENS	WEIGHT-KG	BOX QTY.
VT-120136E	36w	4320	1.91	12 pcs

SKU: 20223 | 4000K DAY WHITE
SKU: 20222 | 6400K WHITE

3
YEAR
WARRANTY

4
FEET

IP65
RATING

120
Lumen/W

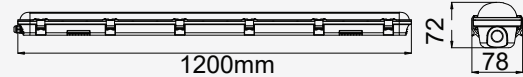

MODEL:	WATTS	LUMENS	WEIGHT-KG	BOX QTY.
VT-150148E	48w	5760	2.21	12 pcs

SKU: 20221 | 4000K DAY WHITE
SKU: 20220 | 6400K WHITE

3
YEAR
WARRANTY

5
FEET

IP65
RATING

120
Lumen/W

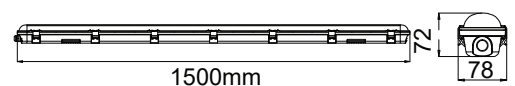

LED LINEAR LIGHTS

V-TAC LED Linear Lights are an energy efficient, low maintenance alternative to traditional linear fluorescent in a variety of industrial, commercial, and light assembly applications. It is the optimal solution for conventional lighting systems and excellent for new installations due to its low installation cost.

KEY FEATURES

- Saves 80% energy
- No Ultraviolet or Infrared Rays
- Totally flexible, Compact & Adjustable design
- No Lead or Mercury content hence environment friendly
- Provides Uniform Radiance & Enhances appeal of any environment
- Continuous row modular system

APPLICATION

Ideal for lighting applications in residential, commercial, and hospitality locations.



COMPLETE RANGE OF LINEAR LIGHTS

Up & Down Linear Lights (Non-Linkable)

One (1) metre stand-alone suspended up & down lighting with cutting-edge reflectors for a soft yet sufficient lighting effect; available in Silver & White



Up & Down Linear Hanging Lights

Continuous suspended upward & downward lighting with a broad 160mm width for a wider scope; modern tech reflectors to distribute just the right amount of light; available in Silver & White

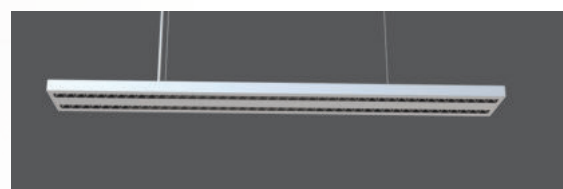

Up & Down Linear Hanging Lights (Slim)

Continuous suspended up & down lighting with a 75mm body; available in Black, Silver, and White

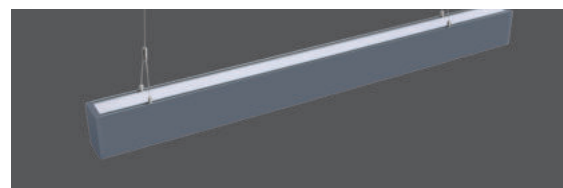

Linear Hanging Lights (Non-Dimmable)

Continuous suspended downward lighting with a narrow 35mm body for a leaner scope; competitively priced for professional task lighting in commercial areas; available in Black, Silver, & White



Linear Hanging Lights (Dimmable)

Dimmable suspended downward lighting with a 50mm body for narrower aisles; continuous up to 12m; available in Silver & White



LED Recessed Linear (Linkable)

Recessed version of our continuous downward linear lighting with a 70mm body; available in Silver & White



LED Recessed Linear (Linkable)

A broader version of our recessed linear lighting at 90mm width; continuous up to 12 metres; available in White



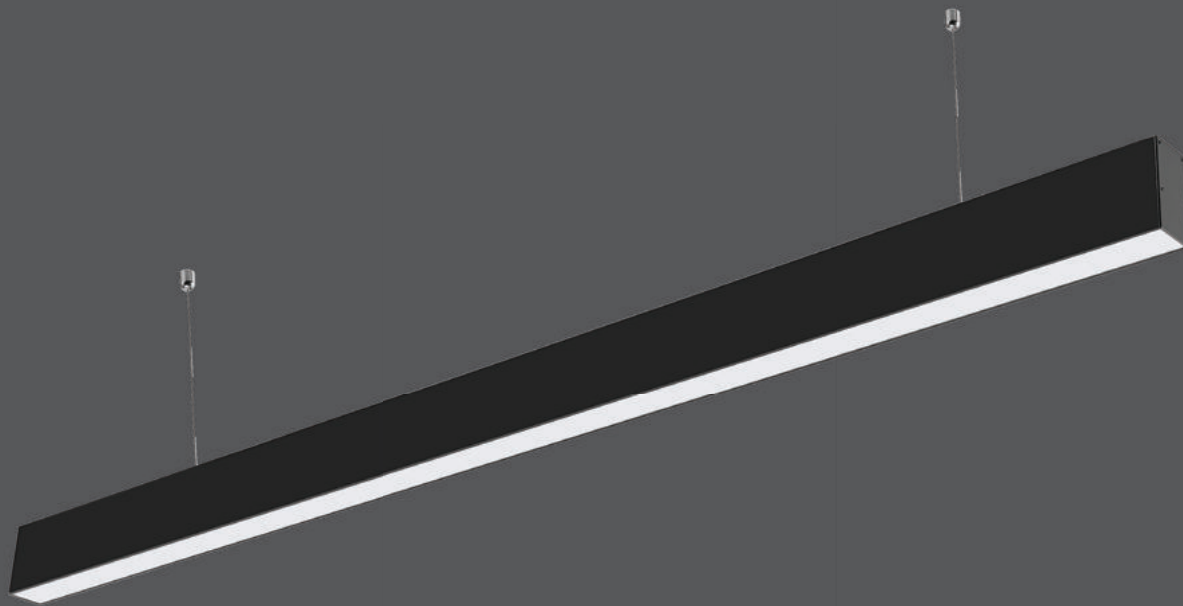

EASY TOGGLE SWITCH



3000K 4000K 6400K

EASY ACCESS FOR
COLOR CHANGING
WITH BUTTON



**COLOR
CHANGING**

LINEAR 3INI LIGHTS

Discover V-TAC's reliable 40w suspended linear lights with a staggering lifespan of 30,000 hours. Designed with toggle switch, 3INI color changing light. Perfect replacement for traditional and inefficient linear lighting fixtures with the efficient LED provided by Samsung.

- **30,000 hrs Lifespan**
- **AC:200-240V,50/60Hz**
- **Toggle switch - 3INI CCT**
- **Aluminum Body**
- **1.5 Meter Wire Length**

5 YEAR
WARRANTY*



BLACK **VT-7-44**

SKU:20060 | 3INI



WATTS	LUMENS	SIZE	BOX QTY.
40w	3200	1200x35x67mm	12 pcs



LED LINEAR LIGHTS



1-10V
DIMMABLE

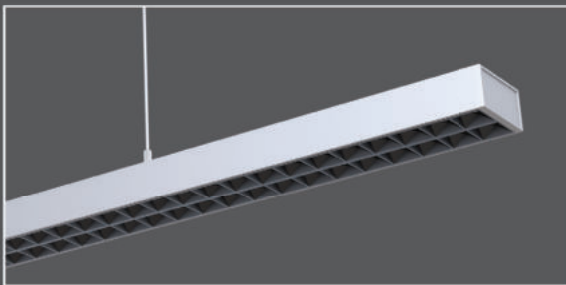

LINEAR HANGING LIGHTS-NON LINKABLE

This modern range of suspended linear lights has up & down illumination for a more evenly distributed light that creates a subtle ambient yet sufficient lighting for any commercial lighting. Linear up & down lights are offered in two colors variants Silver and White.

- **30,000 hrs Lifespan**
- **AC: 100-240V, 50Hz**
- **Aluminum Body**
- **UGR<6**
- **1-10V Dimmable**
- **1.5 Meter Wire Length**

5 YEAR
WARRANTY*

SILVER VT-7-61-S

WHITE VT-7-61-W

SKU:607 | 4000K DAY WHITE

SKU:606 | 4000K DAY WHITE

WATTS LUMENS
UP 30w **UP-3300**
DOWN 30w **DOWN-3300**

SIZE
1179x64x35mm

BOX QTY.
8 pcs

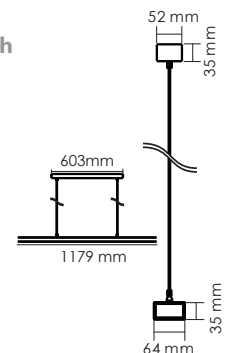

120

LED LINEAR LIGHTS

*Suitable for 10-12 hours daily, usage of the product for 24 hours a day would void warranty

www.v-tac.eu | www.vtacexports.com



LED LINEAR LIGHTS

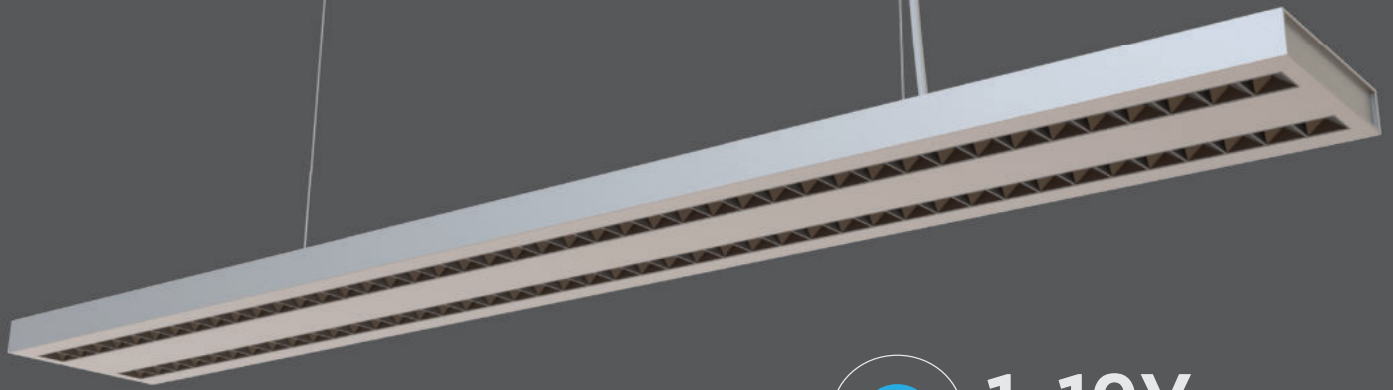

1-10V
DIMMABLE

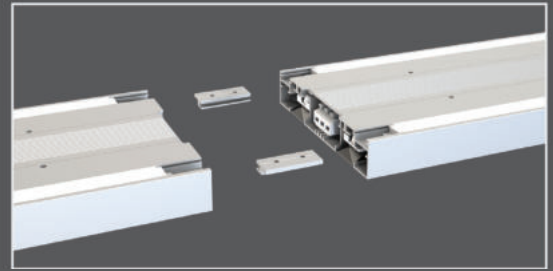
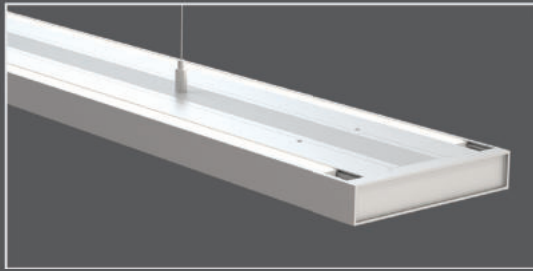

LINEAR HANGING LIGHTS

This modern range of suspended linear lights has up & down illumination for a more evenly distributed light that creates a subtle ambient yet sufficient lighting for any commercial lighting. Linear up & down lights are offered in two colors variants Silver and White.

- **30,000 hrs Lifespan**
- **AC:100-240V,50/60Hz**
- **Aluminum Body**
- **UGR<6**
- **Linkable with connectors**
- **I-10V Dimmable**

5 YEAR
WARRANTY*

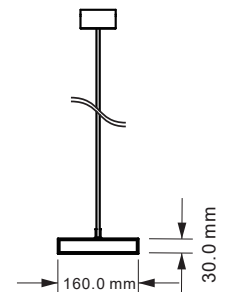
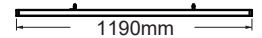

SILVER VT-7-62-S

SKU:609 | 4000K DAY WHITE

WHITE VT-7-62-W

SKU:608 | 4000K DAY WHITE

WATTS	LUMENS
UP 30w	UP-3300
DOWN 30w	DOWN-3300

SIZE
1190x160x30mm

BOX QTY.
4 pcs



LED LINEAR LIGHTS

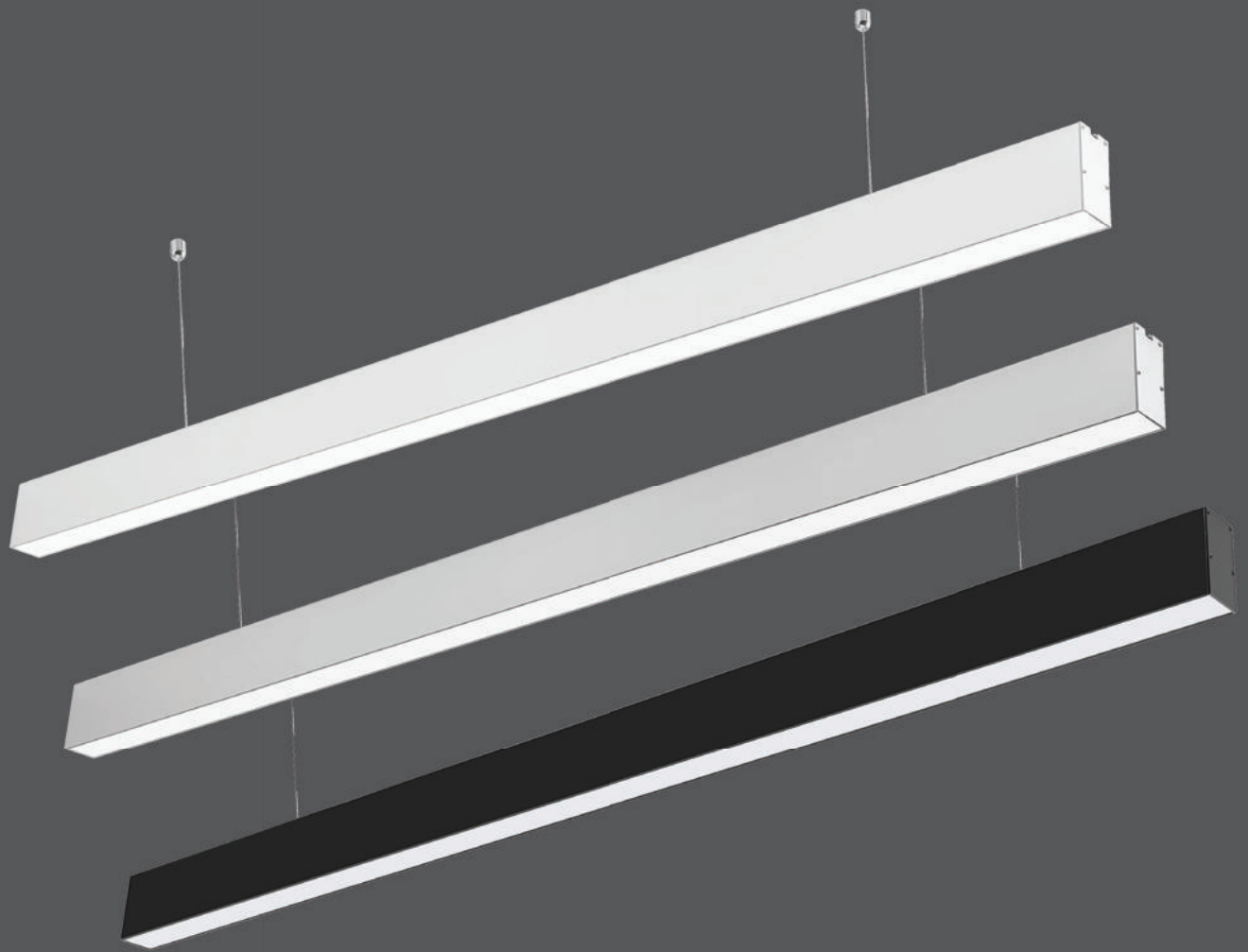

LINEAR HANGING LIGHTS

Discover V-TAC's reliable 40w suspended linear lights with a staggering lifespan of 30,000 hours. Designed with excellent heat dissipation. Perfect replacement for traditional and inefficient linear lighting fixtures with the efficient LED provided by Samsung. Linear lights are offered in three colors variants Black, Silver and White.

- **30,000 hrs Lifespan**
- **AC:200-240V,50/60Hz**
- **1.5 Meter Wire Length**
- **Aluminum Body**

5 YEAR
WARRANTY*

BLACK VT-7-40-B

SKU:882 | 3000K WARM WHITE
SKU:374 | 4000K DAY WHITE
SKU:600 | 6000K WHITE

SILVER VT-7-40-S

SKU:375 | 4000K DAY WHITE
SKU:601 | 6000K WHITE

WHITE VT-7-40-W

SKU:376 | 4000K DAY WHITE
SKU:602 | 6000K WHITE

WATTS	LUMENS	SIZE
40w	3200	1200x35x67mm



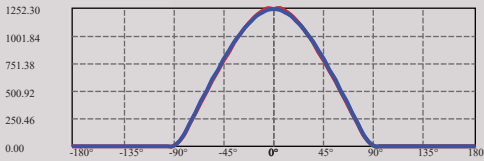
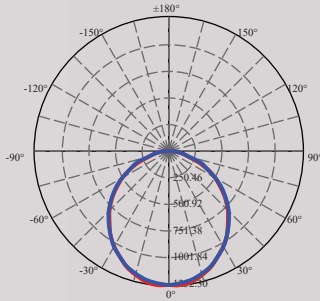

C0(Max): —
 C0/C180: —
 C90/C270: —
 Field angle(10%Imax):C0/180Left:79.2 Right:79.2
 :C90/270Left:79.5 Right:79.5
 Beam Angle(50%Imax):C0/180Left:53.4 Right:53.4
 :C90/270Left:54.1 Right:54.1



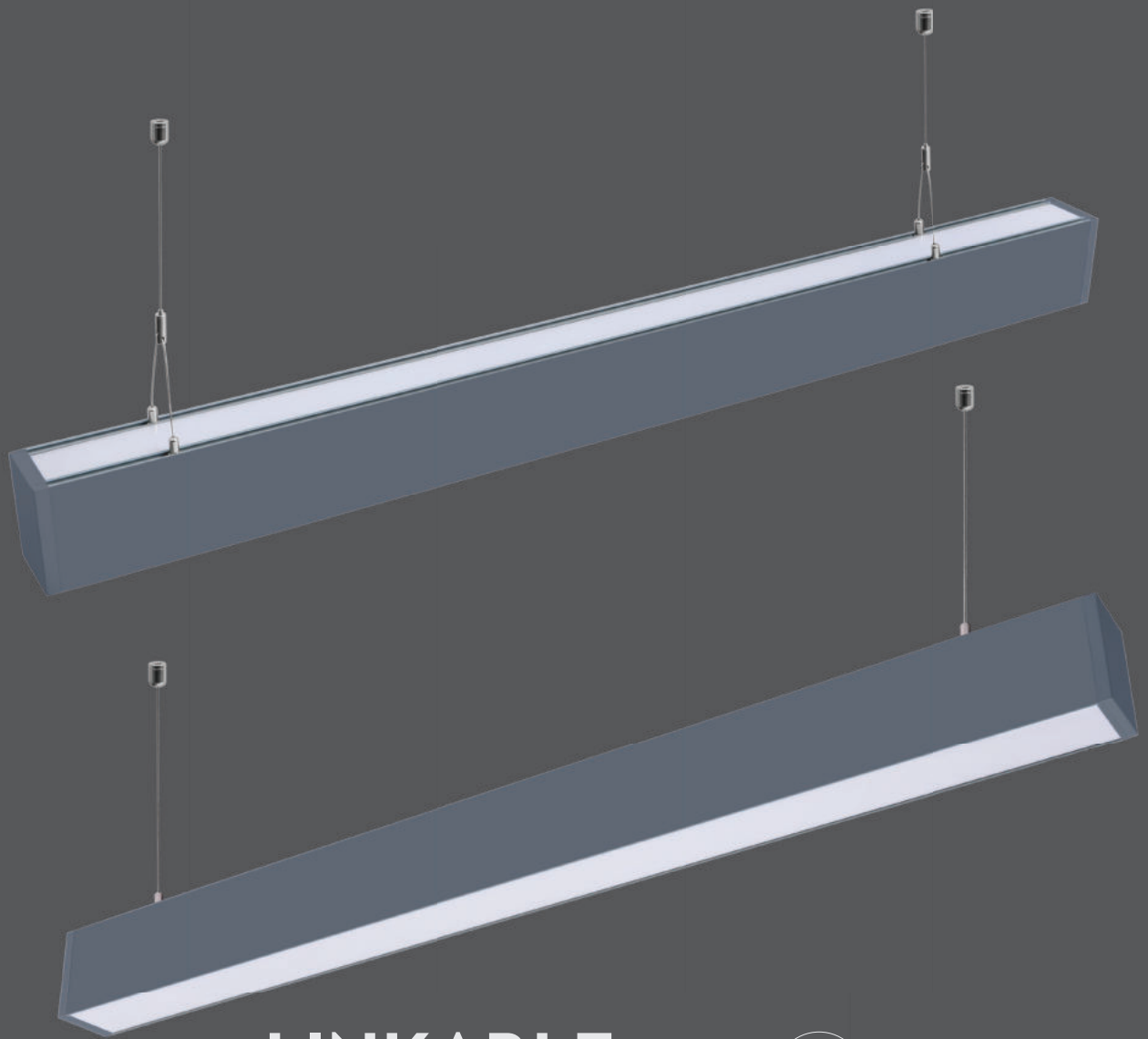

LINKABLE
Up to 12 Meters Together



0-10V
DIMMABLE

LINEAR HANGING UP-DOWN LIGHTS

This modern range of suspended linear lights has up & down illumination for a more evenly distributed light that creates a subtle ambient yet sufficient lighting for any commercial lighting. Linear up & down lights are offered in three colors variants Black, Silver and White.

- **30,000 hrs Lifespan**
- **AC:200-240V,50/60Hz**
- **Aluminum Body**
- **Linkable with connectors**
- **0-10V Dimmable**
- **1.5 Meter Wire Length**

5 YEAR
WARRANTY*

BLACK VT-7-60-B
SKU:379 | 4000K DAY WHITE

SILVER VT-7-60-S
SKU:378 | 4000K DAY WHITE

WHITE VT-7-60-W
SKU:377 | 4000K DAY WHITE

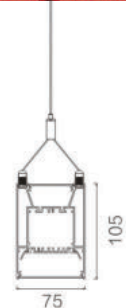

WATTS	LUMENS
UP 20w	UP-2000
DOWN 40w	DOWN-4000

SIZE
1200x75x105mm

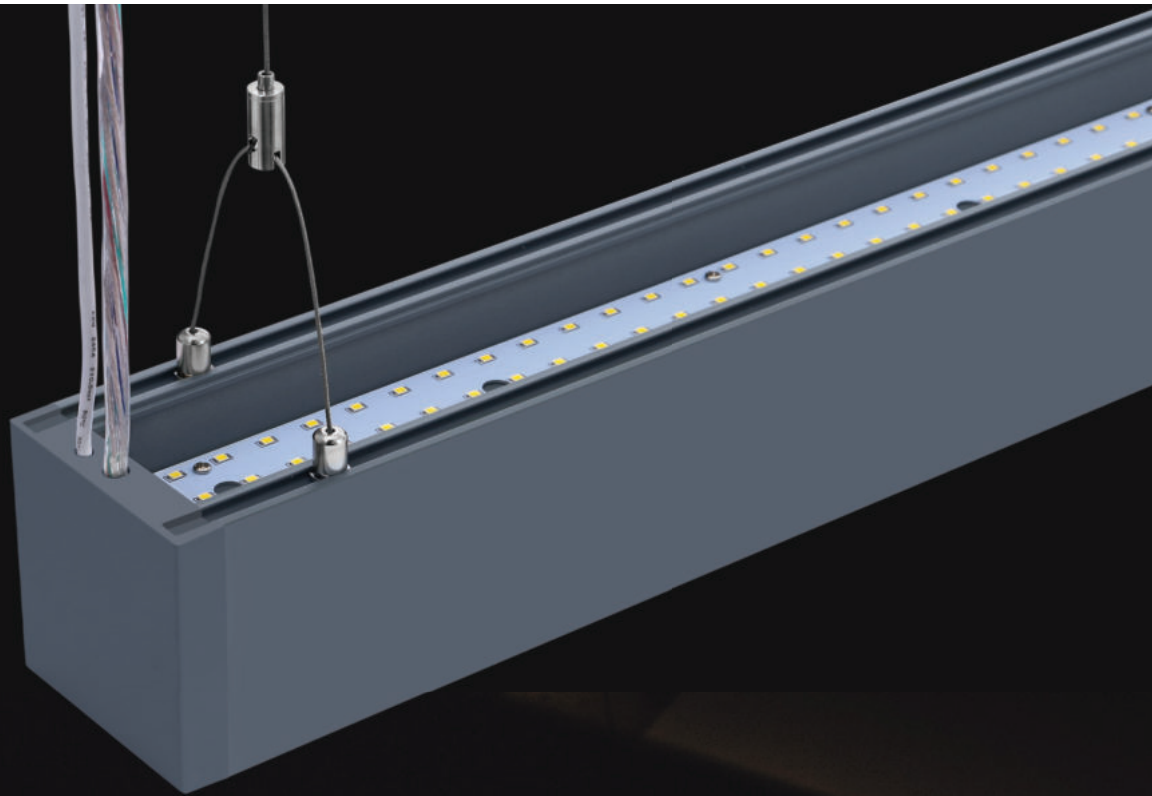



LINKABLE
Up to 12 Meters Together



0-10V
DIMMABLE

LINEAR HANGING LIGHTS

Discover V-TAC's reliable 40w suspended linear lights with a staggering lifespan of 30,000 hours. Designed with excellent heat dissipation. Perfect replacement for traditional and inefficient linear lighting fixtures with the efficient LED provided by Samsung. Linear lights are offered in three colors variants Black, Silver and White.

- **30,000 hrs Lifespan**
- **UGR<19**
- **Linkable with connectors**
- **Aluminum Body**
- **0-10V Dimmable**
- **1.5 Meter Wire Length**

5 YEAR
WARRANTY*

SILVER VT-7-43-S | **WHITE** VT-7-43-W
SKU:384 | 4000K DAY WHITE | SKU:383 | 4000K DAY WHITE



WATTS	LUMENS	SIZE
40w	3400	1200x50x75mm

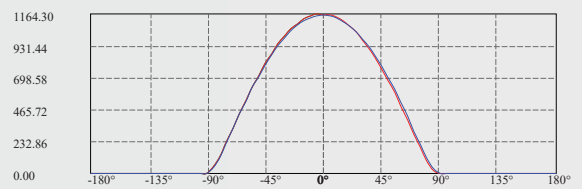
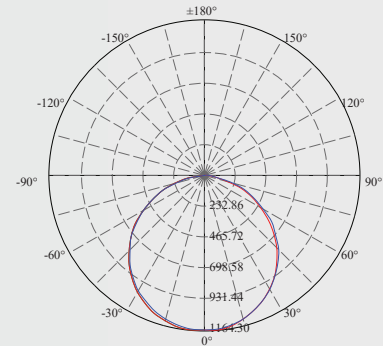

C180(Max): —
 C0/C180: —
 C90/C270: —
 Field angle(10%Imax):C0/180Left:81.0 Right:78.8
 :C90/270Left:80.7 Right:80.0
 Beam Angle(50%Imax):C0/180Left:57.8 Right:55.7
 :C90/270Left:57.6 Right:56.8





LINKABLE
UP TO 12 METERS TOGETHER

LED RECESSED LINEAR

Our new range of linear lights are also available for recessed installation, complete with necessary accessories for a seamless & continuous lighting system. Perfect replacement for traditional and inefficient linear lighting fixtures with the efficient LED provided by Samsung. Linear lights are offered in two colors variants Silver and White.

- **30,000 hrs Lifespan**
- **AC:200-240V,50/60Hz**
- **Linkable with connectors**
- **Aluminum Body**

5 YEAR
WARRANTY*

SILVER **VT-7-41-S**

SKU:380 | 4000K DAY WHITE
SKU:603 | 6000K WHITE

WHITE **VT-7-41-W**

SKU:381 | 4000K DAY WHITE
SKU:604 | 6000K WHITE

WATTS	LUMENS	SIZE
40w	3200	1211x70x35mm

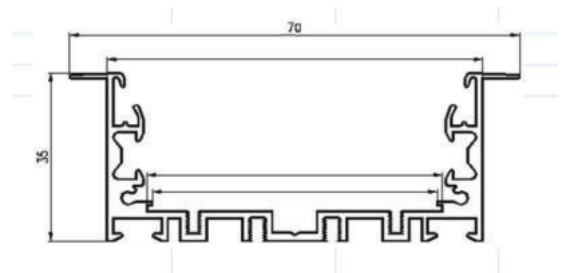

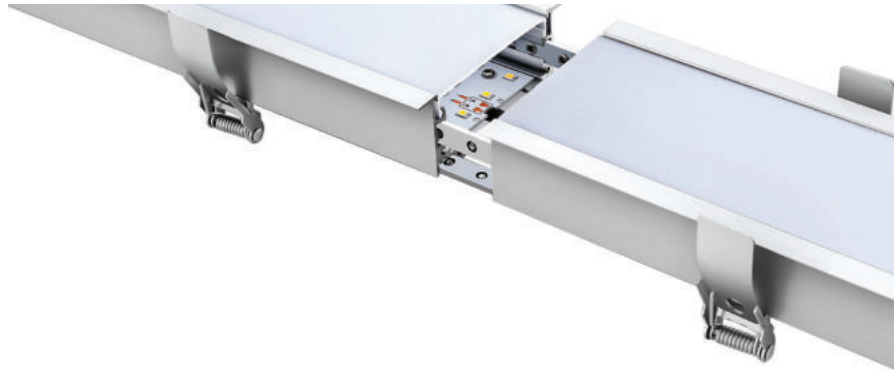
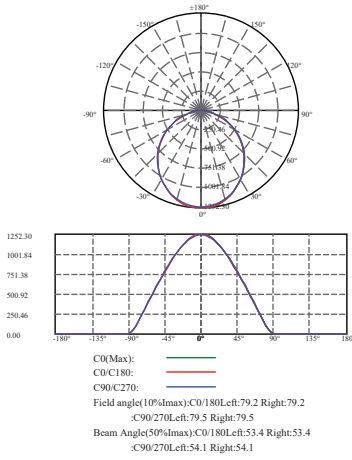

8W
 VT-7-41-L

SILVER: SKU:386 | 4000K DAY WHITE
 WHITE: SKU:385 | 4000K DAY WHITE

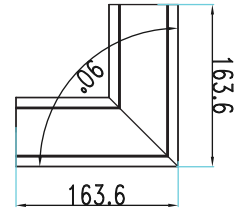

10W
 VT-7-41-LN

SILVER: SKU:388 | 4000K DAY WHITE
 WHITE: SKU:387 | 4000K DAY WHITE

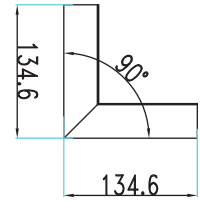

12W
 VT-7-41-LW

SILVER: SKU:390 | 4000K DAY WHITE
 WHITE: SKU:389 | 4000K DAY WHITE

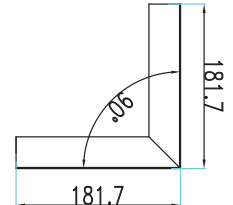

14W
 VT-7-41-T

SILVER: SKU:392 | 4000K DAY WHITE
 WHITE: SKU:391 | 4000K DAY WHITE

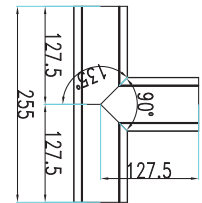

16W
 VT-7-41-X

SILVER: SKU:394 | 4000K DAY WHITE
 WHITE: SKU:393 | 4000K DAY WHITE

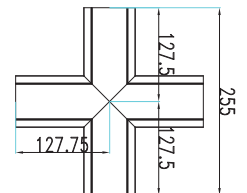



LINKABLE
UP TO 12 METERS TOGETHER

LED RECESSED LINEAR

Our new range of linear lights are also available for recessed installation, complete with necessary accessories for a seamless & continuous lighting system. Perfect replacement for traditional and inefficient linear lighting fixtures with the efficient LED provided by Samsung.

- **30,000 hrs Lifespan**
- **AC:200-240V,50/60Hz**
- **Linkable with connectors**
- **Aluminum Body**

5 YEAR
WARRANTY*

WHITE VT-7-42-W

SKU:382 | 4000K DAY WHITE

WATTS	LUMENS	SIZE
40w	4000	1211x90x35mm

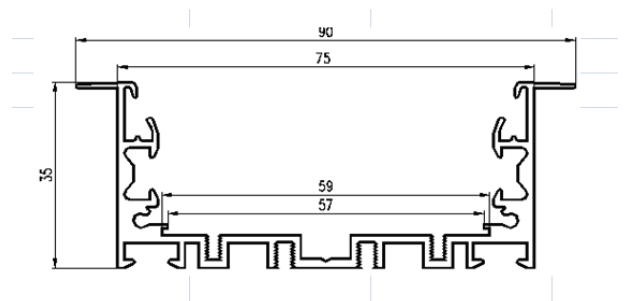

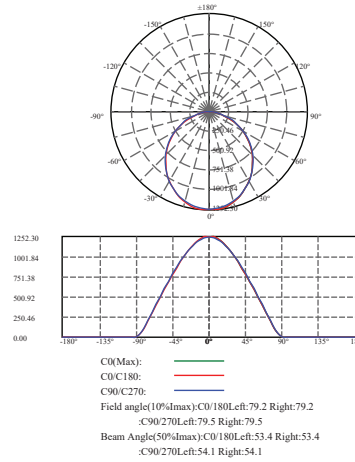

10W
 VT-7-42-L

: SKU:395 | 4000K DAY WHITE

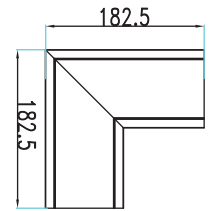

10W
 VT-7-42-LN

: SKU:396 | 4000K DAY WHITE

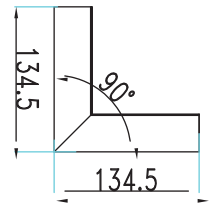

12W
 VT-7-42-LW

: SKU:397 | 4000K DAY WHITE

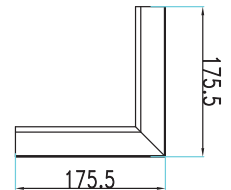

14W
 VT-7-42-T

: SKU:398 | 4000K DAY WHITE

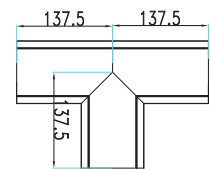

16W
 VT-7-42-X

: SKU:399 | 4000K DAY WHITE

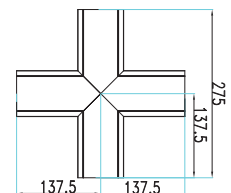



LED LINEAR LIGHTS

V-TAC's new Linear Trunking Light is a set of highly efficient, continuous linear light fixtures with a staggering 160 lm/w rating & a plug-and-play system. It provides an efficient, linkable modular system which means that each unit can be easily connected to the Linear Master Trunking through L, T, and X node connectors. 90°, 120°, and double asymmetric lenses are available for maximum adaptability on any space. Perfect suspended lighting for supermarkets, warehouse, service centers, and gymnasiums. No warm-up time, instant start-up. Sustained color temperature throughout long periods of usage.

High lumen output

output: 160 lm/W to meet different requirements



Flexible Beam angle

90°, 120°, double-asymmetric



Modular system

Continuous row system, seamless connection, max 3500W /row





V-TAC PERFORMANCE
160
 LUMENS/WATT

PRO series

MODEL	WATTS	CRI	LUMENS	PF	SIZE
VT-4551D	50w	>80	8000	>0.9	1500mm

LINEAR MASTER TRUNKING
 SKU: 1360 | 4000K DAY WHITE



90° LENS



DIMMABLE

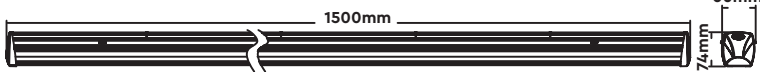
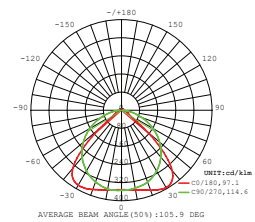

LINEAR MASTER TRUNKING
 SKU: 1361 | 4000K DAY WHITE



120° LENS



DIMMABLE

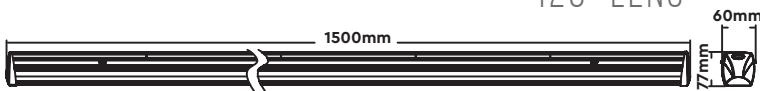
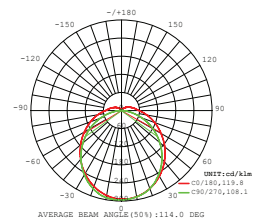

LINEAR MASTER TRUNKING
 SKU: 1362 | 4000K DAY WHITE



DOUBLE ASYMMETRIC LENS



DIMMABLE

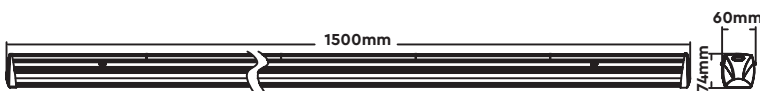
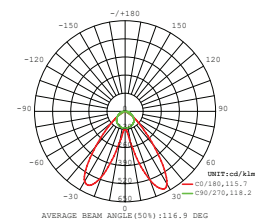

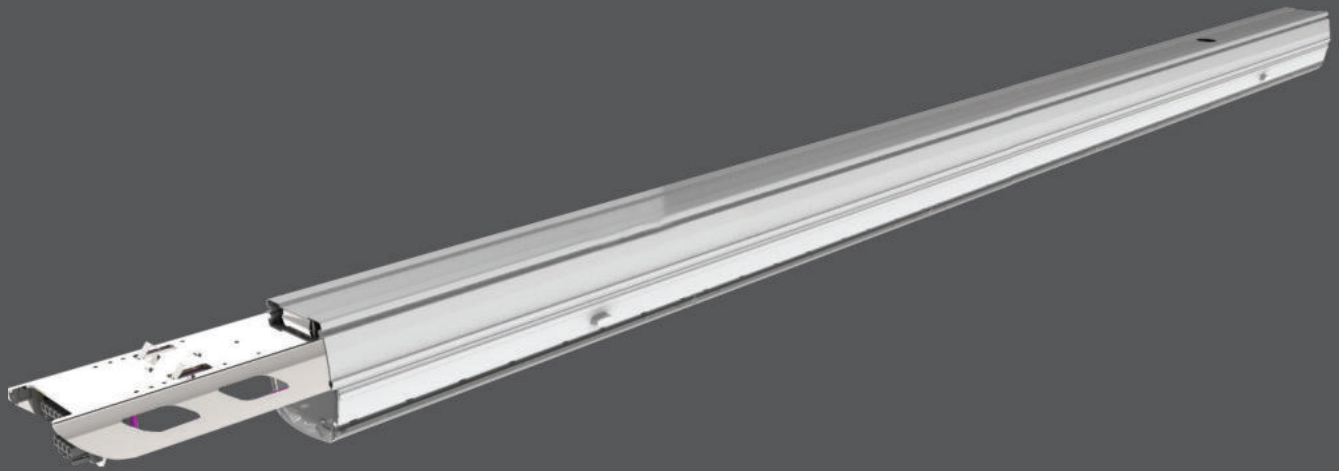

MODEL	WATTS	CRI	LUMENS	PF	SIZE
VT-4550D	50w	>80	8000	>0.9	1500mm

LINEAR FOLLOW TRUNKING
 SKU: 1363 | 4000K DAY WHITE

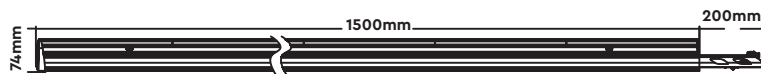
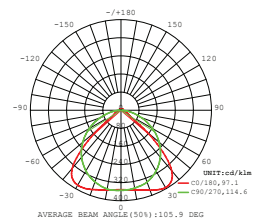

LINEAR FOLLOW TRUNKING
 SKU: 1364 | 4000K DAY WHITE

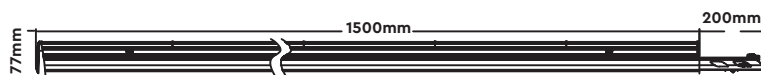
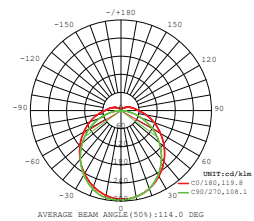

LINEAR FOLLOW TRUNKING
 SKU: 1365 | 4000K DAY WHITE

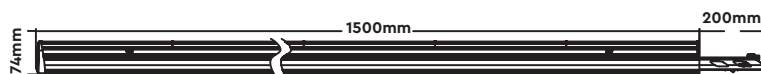
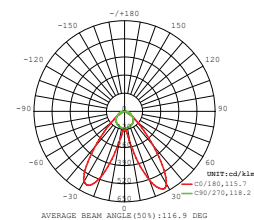

ACCESSORIES FOR LINEAR TRUNKING



LINEAR TRACK MODULE

SKU : 1382



END CAP-LINEAR LIGHT ACCESSORY

SKU : 1366



SUSPENDED CORD-LINEAR LIGHT ACCESSORY

SKU : 1367



8 WIRE-FEED IN MALE CONNECTOR-LINEAR

SKU : 1368



L NODE CONNECTOR-LINEAR ACCESSORY

SKU : 1383



T NODE CONNECTOR-LINEAR ACCESSORY

SKU : 1384



X NODE CONNECTOR-LINEAR ACCESSORY

SKU : 1385



S LINE-FOLLOW TRUNKING RAIL

SKU : 1451



S LINE-PC BLANK COVER

SKU : 1452



Magnetic Track Lights

Magnetic light is a kind of track light which is designed by using magnets fast adsorption characteristic. It consists of two parts: track magnet and light. The track has four ways: surface mounted, recessed, borderless embedded installation, suspension. The light consists of anti-glare line light, anti-glare high power light, soft light lamp, suspension light and decorative lamp. The light can be used alone or assembled at will. Lighting effect can achieve point, line, surface combination, not only to meet the needs of various lighting effects, but also convenient installation, fashionable style, can greatly enhance the decorative effect, in line with the modern architectural design concept, is a fashionable, high-end LED lights leading the trend in the future, is the ideal choice of office, exhibition hall, exclusive stores, hotels, villas and clubs.

Magnetic Linear Spotlight

1W VT-4141



SKU: 7958 - 3000K Warm White 3800157652766
 SKU: 7959 - 4000K Day White 3800157652773

Voltage/Frequency:	DC:24V	Beam Angle:	30°
Luminous Flux:	35lm	Body Type:	Aluminium
LED Type:	SMD	Life span:	30,000 Hours
CRI:	>90	Dimension:	45x35x59mm
Color of Fixture:	Black	Box Qty:	40 PCS



3 YEAR WARRANTY

UGR<19

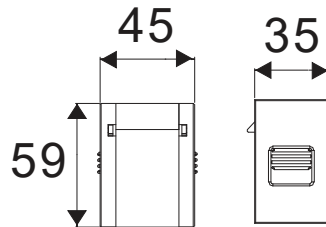

Magnetic Linear Spotlight

3W VT-4143



SKU: 7960 - 3000K Warm White 3800157652780
 SKU: 7961 - 4000K Day White 3800157652797

Voltage/Frequency:	DC:24V	Beam Angle:	30°
Luminous Flux:	240lm	Body Type:	Aluminium
LED Type:	SMD	Life span:	30,000 Hours
CRI:	>90	Dimension:	106x35x59mm
Color of Fixture:	Black	Box Qty:	36 PCS



3 YEAR WARRANTY

UGR<19

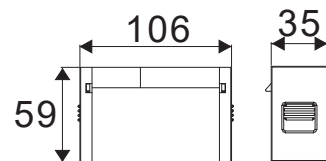

Magnetic Linear Track Light

10w VT-4210



SKU: 7962 - 3000K Warm White 3800157652803
 SKU: 7963 - 4000K Day White 3800157652810

Voltage/Frequency:	DC:24V	Beam Angle:	30°
Luminous Flux:	700lm	Body Type:	Aluminium
LED Type:	SMD	Life span:	30,000 Hours
CRI:	>90	Dimension:	137x35x180mm
Color of Fixture:	Black	Box Qty:	16 PCS



3 YEAR WARRANTY

UGR<19

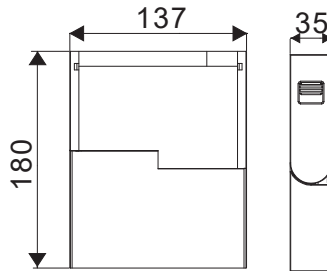

Magnetic Linear Track Light

20w VT-4220



SKU: 7964 - 3000K Warm White 3800157652827
 SKU: 7965 - 4000K Day White 3800157652834

Voltage/Frequency:	DC:24V	Beam Angle:	30°
Luminous Flux:	1200lm	Body Type:	Aluminium
LED Type:	SMD	Life span:	30,000 Hours
CRI:	>90	Dimension:	270x35x180mm
Color of Fixture:	Black	Box Qty:	8 PCS



3 YEAR WARRANTY

UGR<19

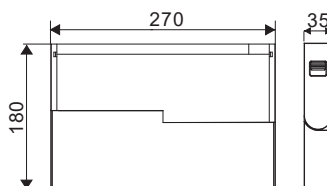

Magnetic Spotlight

15w VT-4215



SKU: 7966 - 3000K Warm White 3800157652841
 SKU: 7967 - 4000K Day White 3800157652858

Voltage/Frequency:	DC:24V	Beam Angle:	36°
Luminous Flux:	900lm	Body Type:	Aluminium
LED Type:	COB	Life span:	30,000 Hours
CRI:	>90	Dimension:	166x100x55mm
Color of Fixture:	Black	Box Qty:	16 PCS



3 YEAR WARRANTY*

UGR<19

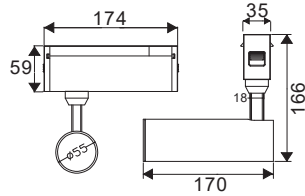

Magnetic Pendant Light

15w VT-4315



SKU: 7968 - 3000K Warm White 3800157652865
 SKU: 7969 - 4000K Day White 3800157652872

Voltage/Frequency:	DC:24V	Beam Angle:	36°
Luminous Flux:	1000lm	Body Type:	Aluminium
LED Type:	COB	Life span:	30,000 Hours
CRI:	>90	Dimension:	300x55mm
Color of Fixture:	Black	Box Qty:	12 PCS



3 YEAR WARRANTY*

UGR<19

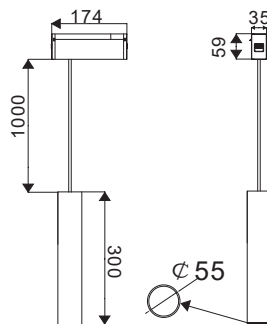

Magnetic Linear Light

20w VT-4121



SKU: 7954 - 3000K Warm White 3800157652728
 SKU: 7955 - 4000K Day White 3800157652735

Voltage/Frequency:	DC:24V	Beam Angle:	100°
Luminous Flux:	1600lm	Body Type:	Aluminium
LED Type:	SMD	Life span:	30,000 Hours
CRI:	>90	Dimension:	652x35x59mm
Color of Fixture:	Black	Box Qty:	12 PCS



3 YEAR WARRANTY*

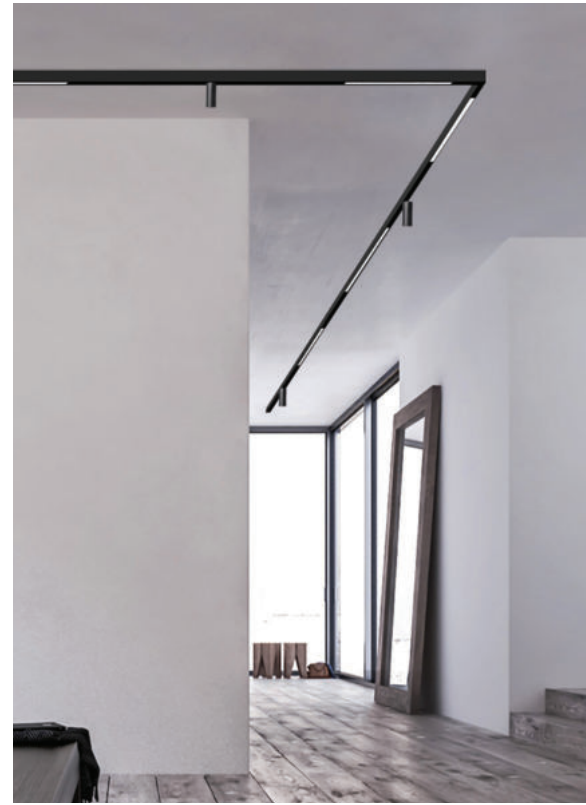

Magnetic Linear Light

30w VT-4131

















SKU: 7956 - 3000K Warm White 3800157652742
 SKU: 7957 - 4000K Day White 3800157652759

Voltage/Frequency:	DC:24V	Beam Angle:	100°
Luminous Flux:	2700lm	Body Type:	Aluminium
LED Type:	SMD	Life span:	30,000 Hours
CRI:	>90	Dimension:	970x35x59mm
Color of Fixture:	Black	Box Qty:	12 PCS

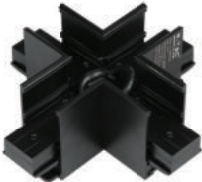

3 YEAR WARRANTY*



<p>NEW</p>  <p>Track Rail-0.5M SKU : 7950 EAN : 3800157652681 Box Qty: 9 PCS</p>	<p>NEW</p>  <p>Track Rail-1M SKU : 7951 EAN : 3800157652698 Box Qty: 9 PCS</p>	<p>NEW</p>  <p>Track Rail-1.5M SKU : 7953 EAN : 3800157652711 Box Qty: 6 PCS</p>	<p>NEW</p>  <p>Track Rail-2M SKU : 7952 EAN : 3800157652704 Box Qty: 6 PCS</p>
<p>NEW</p>  <p>Recessed Kit for Magnetic Tracklight SKU : 7970 EAN : 3800157652889 Box Qty: 75 PCS</p>	<p>NEW</p>  <p>Track Connector SKU : 7971 EAN : 3800157652896 Box Qty: 180 PCS</p>	<p>NEW</p>  <p>90'D Corner Connector SKU : 7972 EAN : 3800157652902 Box Qty: 27 PCS</p>	<p>NEW</p>  <p>Outer Corner Connector SKU : 7973 EAN : 3800157652919 Box Qty: 27 PCS</p>
<p>NEW</p>  <p>Cross Connector SKU : 7974 EAN : 3800157652926 Box Qty: 36 PCS</p>	<p>NEW</p>  <p>T Type Connector SKU : 7975 EAN : 3800157652933 Box Qty: 36 PCS</p>	<p>NEW</p>  <p>Pendant Track Rail Accessory SKU : 7977 EAN : 3800157652957 Box Qty: 150 PCS</p>	<p>NEW</p>  <p>Track Cover SKU : 7978 EAN : 3800157652964 Box Qty: 200 PCS</p>
<p>NEW</p>  <p>Live End Connector SKU : 7979 EAN : 3800157652971 Box Qty: 200 PCS</p>	<p>NEW</p>  <p>Transformer SKU : 11144 Watts : 100w EAN : 3800157652988 Input : AC:86-265V,50/60Hz Box Qty: 30 PCS Current: 4.16A Output: DC:24V</p>		<p>NEW</p>  <p>Transformer SKU : 11145 Watts : 200w EAN : 3800157652995 Input : AC:86-265V,50/60Hz Box Qty: 30 PCS Current: 8.33A Output: DC:24V</p>



LED TRACK LIGHTS

Color has a massive influence on purchasing decisions and setting the mood in any room. Our innovative LED track lights are the premiere choice for retail lighting with Samsung's state-of-the-art COB technology.

The >90 CRI rating of these track lights provide vivid colors, highly enhancing any product's appeal to consumers. Single and 4-linear track lights are included in this new generation of track lights from V-TAC.

APPLICATION

Ideal for lighting applications in residential, commercial, and hospitality locations.





KEY FEATURES

- Saves 80% energy
- No Ultraviolet or Infrared Rays
- Totally flexible, Compact & Adjustable design
- No Lead or Mercury content hence environment friendly
- Provides Uniform Radiance & Enhances appeal of any environment.
- Enhances measurable levels of performance as compared to older versions of high wattage halogen & HID light sources in retail & Commercial Lighting applications.

NEW

5 YEAR
WARRANTY*

LED TRACKLIGHTS

Linear Tracklights

Experience true colours through our LED Linear Tracklights efficient set of track lights with CRI >90, UGR<19 and flicker free. The latest LED technology from Samsung, and five years of warranty.

- 30,000 hrs Lifespan
- 30° Beam Angle
- AC:220-240V,50Hz
- Flicker Free
- High CRI of > 90
- Aluminum Body
- UGR<19



UGR<19



MODEL	WATTS	LUMENS	PF	CRI	BOX QTY.	BEAM ANGLE
VT-416-B	12W	960	>0.5	>90	40 pcs	30°

SKU: 20000 | 2700K WARM WHITE
SKU: 20001 | 4000K DAY WHITE

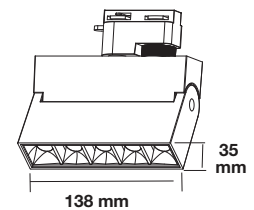

MODEL	WATTS	LUMENS	PF	CRI	BOX QTY.	BEAM ANGLE
VT-431-B	25W	2000	>0.9	>90	20 pcs	30°

SKU: 20006 | 2700K WARM WHITE
SKU: 20007 | 4000K DAY WHITE

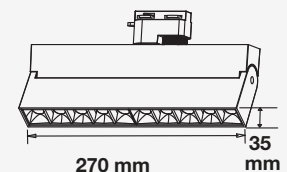

NEW

5 YEAR
WARRANTY*

LED TRACKLIGHTS

Linear Tracklights

Experience true colours through our LED Linear Tracklights efficient set of track lights with CRI >90, UGR<19 and flicker free. The latest LED technology from Samsung, and five years of warranty.

- 30,000 hrs Lifespan
- 30° Beam Angle
- AC:220-240V,50Hz
- Flicker Free
- High CRI of > 90
- Aluminum Body
- UGR<19



UGR<19



MODEL	WATTS	LUMENS	PF	CRI	BOX QTY.	BEAM ANGLE
VT-416-W	12W	960	>0.5	>90	40 pcs	30°

SKU: 20003 | 2700K WARM WHITE
SKU: 20004 | 4000K DAY WHITE

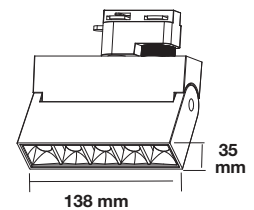

MODEL	WATTS	LUMENS	PF	CRI	BOX QTY.	BEAM ANGLE
VT-431-W	25W	2000	>0.9	>90	20 pcs	30°

SKU: 20009 | 2700K WARM WHITE
SKU: 20010 | 4000K DAY WHITE

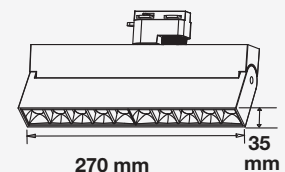

LED TRACKLIGHTS

4 Line Tracklights-Black Body

A complete range of durable 7w to 20w 4-line LED track lights with aluminum body equipped with LED Chip by Samsung. These COB LEDs are also renowned for its high-CRI rating, perfect for retail lighting. Available in a stylish, ebony black finish.

5 YEAR
WARRANTY*

- **COB LED Type**
- **30,000 hrs Lifespan**
- **24° Beam Angle**
- **AC:220-240V,50Hz**
- **High CRI of > 90**
- **Aluminum Body**



MODEL	WATTS	LUMENS	PF	CRI	BOX QTY.	BEAM ANGLE
VT-407-B	7w	420	>0.5	>90	40 pcs	24°

- SKU: 353 | 3000K WARM WHITE
- SKU: 354 | 4000K DAY WHITE
- SKU: 355 | 5000K WHITE

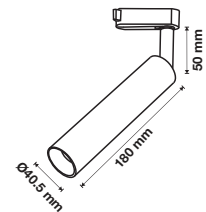

MODEL	WATTS	LUMENS	PF	CRI	BOX QTY.	BEAM ANGLE
VT-415-B	15w	1050	>0.5	>90	40 pcs	24°

- SKU: 359 | 3000K WARM WHITE
- SKU: 360 | 4000K DAY WHITE
- SKU: 361 | 5000K WHITE

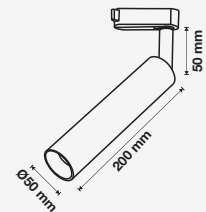

MODEL	WATTS	LUMENS	PF	CRI	BOX QTY.	BEAM ANGLE
VT-420-B	20w	1400	>0.9	>90	40 pcs	24°

- SKU: 365 | 3000K WARM WHITE
- SKU: 366 | 4000K DAY WHITE
- SKU: 367 | 5000K WHITE

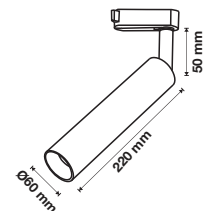

LED TRACKLIGHTS

4 Line Tracklights-White Body

A complete range of durable 7w to 20w 4-line LED track lights with aluminum body equipped with LED Chip by Samsung. These COB LEDs are also renowned for its high-CRI rating, perfect for retail lighting. Available in a stylish, clean white finish.

5 YEAR
WARRANTY*

- **COB LED Type**
- **30,000 hrs Lifespan**
- **24° Beam Angle**
- **AC:220-240V,50Hz**
- **High CRI of > 90**
- **Aluminum Body**



MODEL	WATTS	LUMENS	PF	CRI	BOX QTY.	BEAM ANGLE
VT-407-W	7w	490	>0.5	>90	40 pcs	24°

- SKU: 350 | 3000K WARM WHITE
- SKU: 351 | 4000K DAY WHITE
- SKU: 352 | 5000K WHITE

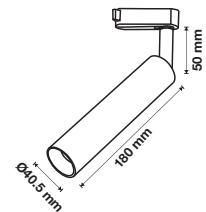

MODEL	WATTS	LUMENS	PF	CRI	BOX QTY.	BEAM ANGLE
VT-415-W	15w	1200	>0.5	>90	40 pcs	24°

- SKU: 356 | 3000K WARM WHITE
- SKU: 357 | 4000K DAY WHITE
- SKU: 358 | 5000K WHITE

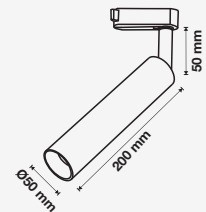

MODEL	WATTS	LUMENS	PF	CRI	BOX QTY.	BEAM ANGLE
VT-420-W	20w	1600	>0.9	>90	40 pcs	24°

- SKU: 362 | 3000K WARM WHITE
- SKU: 363 | 4000K DAY WHITE
- SKU: 364 | 5000K WHITE

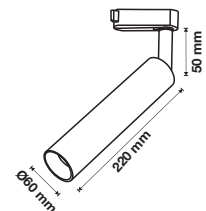

NEW

5 YEAR
WARRANTY*

LED TRACKLIGHTS

4 line Tracklights-Black Body

Experience true colours through our LED Tracklights efficient set of track lights with CRI >90, the latest LED technology from Samsung, and five years of warranty.

- **COB LED Type**
- **30,000 hrs Lifespan**
- **24° Beam Angle**
- **AC:220-240V,50Hz**
- **PF: >0.9**
- **High CRI of > 90**
- **Aluminum Body**



MODEL	WATTS	LUMENS	PF	CRI	BOX QTY.	BEAM ANGLE
VT-418	18w	1260	>0.9	>90	20 pcs	24°

SKU: 939 | 3000K WARM WHITE

SKU: 940 | 4000K DAY WHITE

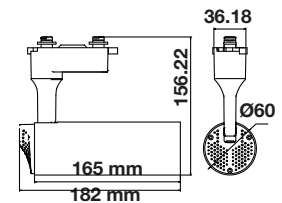

MODEL	WATTS	LUMENS	PF	CRI	BOX QTY.	BEAM ANGLE
VT-430	30w	2100	>0.9	>90	20 pcs	24°

SKU: 941 | 3000K WARM WHITE

SKU: 942 | 4000K DAY WHITE

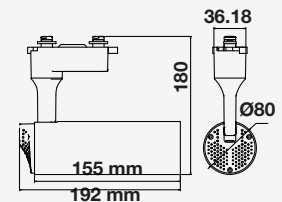

LED TRACKLIGHTS

LED Shutter Tracklights

These durable 4-line LED track lights are equipped with shutters for flexibility — easily adjust them to achieve desired beam angle. These COB LEDs are also renowned for its high-CRI rating, perfect for retail lighting. Available in white and black body.

- **COB LED Type**
- **30,000 hrs Lifespan**
- **24°-60° Adjustable**
- **AC:220-240V,50Hz**
- **High CRI of > 90**
- **Aluminum Body**



5 YEAR
WARRANTY*

MODEL	WATTS	LUMENS	PF	CRI	BOX QTY.	BEAM ANGLE
VT-433-B	33w	2640	>0.9	>90	8 pcs	24°-60° Adjustable

- SKU: 371 | 3000K WARM WHITE
- SKU: 372 | 4000K DAY WHITE
- SKU: 373 | 5000K WHITE

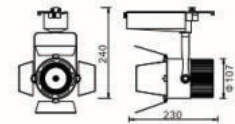

MODEL	WATTS	LUMENS	PF	CRI	BOX QTY.	BEAM ANGLE
VT-433-W	33w	2640	>0.9	>90	8 pcs	24°-60° Adjustable

- SKU: 368 | 3000K WARM WHITE
- SKU: 369 | 4000K DAY WHITE
- SKU: 370 | 5000K WHITE

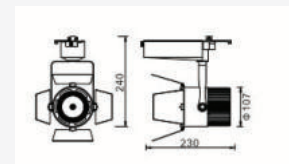



LED BULKHEAD LIGHTS

V-TAC's LED Bulkhead range is inclusive of IP65-rated 2D bulkheads made of state-of-the-art polycarbonate resins for a premium water and dustproof surface-mounted luminaire.

Each model has powerful combinations of two useful features: the emergency battery backup and the microwave sensor with 120°D detection angle. Together with the new elegant designs, this luminaire's highlight is its competitive outdoor effectiveness in efficiency and security.

APPLICATION

Ideal for lighting applications in residential, commercial, and hospitality locations.





KEY FEATURES

- Four-options available: 3-in-1 2D Bulkhead with Emergency Battery Back-up & Microwave Sensor, 2D Bulkhead with Emergency Battery Back-up only, 2D Bulkhead with Microwave Sensor only, and stand-alone 2D Bulkhead with 5-years warranty
- Built-in power eliminates the need for an external power supply
- IP65 and strong PC covers for durability
- 3-hour Emergency Operation Time
- Microwave sensors: up to 10m detection
- upto 30,000hr lifespan
- Fully compatible with daylight sensors
- Equipped with a green LED charging indicator
- Suitable for open areas constantly exposed to dust and moisture like parking lots, corridors, airports, and malls.



**Microwave
Sensor**



**Emergency
Battery Backup**



**Bulkhead
Emergency
Battery Backup
Microwave Sensor**

NEW

CCT BULKHEAD

EMERGENCY
BATTERY
BACKUP 

MICROWAVE
SENSOR

31 IN 
EMERGENCY
BATTERY BACKUP

MICROWAVE SENSOR

 **IP65**
RATING

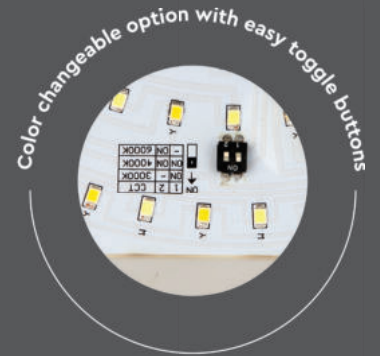
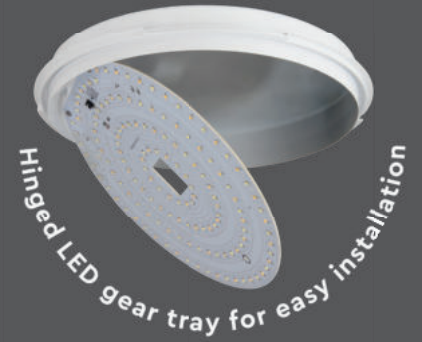

LED BULKHEAD

CCT Adjustable

A new addition to our Dome Light Lights series, V-TAC's new CCT Bulkhead are re-designed with a sleeker, more compact built for a modern look – perfect lighting for outdoor areas in residential, business, and industrial zones.

- SMD LED Chip
- AC:200-240V,50/60Hz
- 30,000 hrs Lifespan
- 120° Beam Angle
- PC Body
- CRI >80
- PF >0.5
- IP65

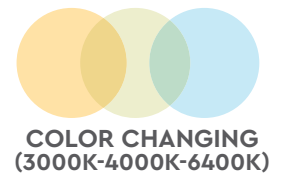

CCT Bulkhead

Our resilient IP65 CCT Bulkhead make a good choice for outdoor residential, business, and industrial areas that need constant lighting since they can withstand weather and dust.

MODEL	WATTS	LUMENS	BOX QTY.	SKU: 20088 3IN1
VT-14	14w	1400	10 pcs	UNIT COLOR: WHITE

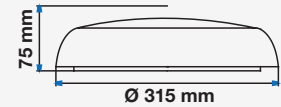

MODEL	WATTS	LUMENS	BOX QTY.	SKU: 20092 3IN1
VT-14-CH	14w	1400	10 pcs	UNIT COLOR: CHROME

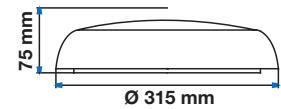

MODEL	WATTS	LUMENS	BOX QTY.	SKU: 20093 3IN1
VT-24	20w	1850	10 pcs	UNIT COLOR: WHITE

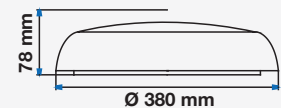

MODEL	WATTS	LUMENS	BOX QTY.	SKU: 20097 3IN1
VT-24-CH	20w	1850	10 pcs	UNIT COLOR: CHROME

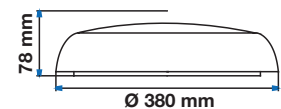

CCT Bulkhead with Emergency Battery



**Emergency
Battery Backup**

- AC:200-240V,50/60Hz
- 30,000 hrs Lifespan
- 120° Beam Angle
- PC Body
- Emergency Operation Time:>3 Hours
- Emergency Standby Watts:>1.5W
- Battery Charging Current:60mA
- Battery Discharging Current:200mA
- Battery Type:Ni-CD, 9.6V 1.0Ah
- Charging Indication:Green LED
- Including Test Button, Battery Protection circuit & Inhibiting Mode

**3 YEAR
WARRANTY***

MODEL	WATTS	LUMENS	BOX QTY.	SKU: 20090 3IN1
VT-14SE	14w	1400	10 pcs	UNIT COLOR: WHITE

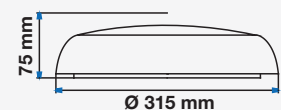

MODEL	WATTS	LUMENS	BOX QTY.	SKU: 20095 3IN1
VT-24SE	20w	1850	10 pcs	UNIT COLOR: WHITE

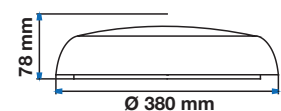

SLIM DOME LIGHTS

CCT Bulkhead with Sensor



This range of CCT Bulkhead are recommended for purposes of increasing security in garages, walkways, and parking areas. With competitive detection range and dimmable functions, these Dome Lights exhibit exceptional performance in outdoor security lighting.

- **AC:200-240V,50/60Hz**
- **30,000 hrs Lifespan**
- **120° Beam Angle**
- **PC Body**
- **Detection Angle:Ceiling/Wall Mounted-360°/120°**
- **Detection Distance:3-6M, 6-10M Optional**
- **Detection Range:Max DI 0M*6M**
- **Hold Time:5s,90s,5min,10min customized**
- **Daylight Sensor:Day,2lux,10lux,50lux optional**
- **Dimmable Function:Yes,0%,10%,20%,30% optional**
- **Standby period:0s,10s,10min optional**
- **Manual Override:Available by dial switch**
- **Detection Motion Speed:0.5-3m/s**

5 YEAR WARRANTY*

MODEL	WATTS	LUMENS	BOX QTY.	SKU: 20089 3IN1 UNIT COLOR: WHITE
VT-14SS	14w	1400	10 pcs	

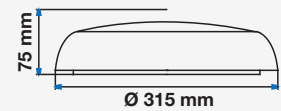

MODEL	WATTS	LUMENS	BOX QTY.	SKU: 20094 3IN1 UNIT COLOR: WHITE
VT-24SS	20w	1850	10 pcs	

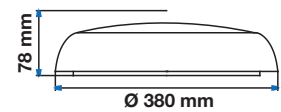

Changeable cover and rim options available



Chrome Rim For 14W

SKU: 11230



Eyelid Half Cover For 14W

SKU: 11225



Chrome Rim For 20W

SKU: 11231

CCT Bulkhead with Emergency Battery+Sensor

3in1 Bulkhead
Emergency Battery Backup
Microwave Sensor

Our 3-in-1 CCT Bulkhead range is equipped with the complete package for a remarkable and reliable indoor/outdoor emergency and security lighting. With reliable Ni-Cd emergency battery back up, advanced microwave sensor, and optional dimmable functions, this range has impressive lighting abilities to make outdoor locations of residential, business, and industrial areas safer and easier to navigate.

- AC:200-240V,50/60Hz
- 30,000 hrs Lifespan
- 120° Beam Angle
- PC Body
- Emergency Operation Time:>3 Hours
- Emergency Standby Watts:>1.5W
- Battery Charging Current:60mA
- Battery Discharging Current:200mA
- Battery Type:Ni-CD, 9.6V 1.0Ah
- Charging Indication:Green LED
- Including,Test Button, Battery Protection circuit & Inhibiting Mode
- Detection Angle:Ceiling/Wall Mounted-360°/120°
- Detection Distance:3-6M, 6-10M Optional
- Detection Range:Max D10M*6M
- Hold Time:5s,90s,5min,10min customized
- Daylight Sensor:Day,2lux,10lux,50lux optional
- Dimmable Function:Yes,0%,10%,20%,30% optional
- Stand-by period:0s,10s,10min optional
- Manual Override:Available by dial switch
- Detection Motion Speed:0.5-3m/s

3 YEAR WARRANTY*

MODEL	WATTS	LUMENS	BOX QTY.	SKU: 20091 3IN1
VT-14SES	14w	1400	10 pcs	UNIT COLOR: WHITE

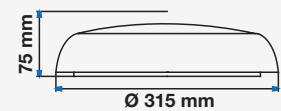

MODEL	WATTS	LUMENS	BOX QTY.	SKU: 20096 3IN1
VT-24SES	20w	1850	10 pcs	UNIT COLOR: WHITE

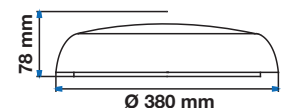

2D BULKHEAD

EMERGENCY
BATTERY
BACKUP 

MICROWAVE
SENSOR

3.1 IN 
EMERGENCY
BATTERY BACKUP

MICROWAVE SENSOR

 **IP65**
RATING



LED DOME LIGHTS

2D Bulkhead

Our resilient IP65 LED bulkheads make a good choice for outdoor residential, business, and industrial areas that need constant lighting since they can withstand weather, dust, and vandalism.

- SMD LED Chip
- AC:200-240V,50/60Hz
- 30,000 hrs Lifespan
- 120° Beam Angle
- PC Body
- CRI >80
- IP65

5 YEAR
WARRANTY*



 **IK08**
RATING

2D Bulkhead

Our resilient IP65 LED bulkheads make a good choice for outdoor residential, business, and industrial areas that need constant lighting since they can withstand weather, dust, and vandalism.

MODEL	WATTS	LUMENS	BOX QTY.	SKU: 815 4000K DAY WHITE
VT-08	8w	720	10 pcs	

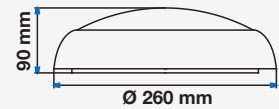

MODEL	WATTS	LUMENS	BOX QTY.	SKU: 801 4000K DAY WHITE SKU: 802 6400K WHITE
VT-15	15w	1400	10 pcs	

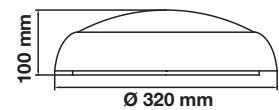

2D Bulkhead with Emergency Battery Backup



These IP65 LED bulkheads are equipped with Ni-Cad batteries that automatically charges while in use. These fixtures can operate up to three (3) hrs on emergency situations.

- AC:200-240V,50/60Hz
- >1.2 Watts Emergency Standby Watts
- 60mA Battery Charging Current
- 200mA Battery Discharging Current
- Ni-CD AA, 7.2V 1.0Ah Battery Type
- Green LED Charging indicate
- Including battery protection circuit & inhibiting mode
- PC Body type
- >3 hrs Emergency Operation time
- SMD LED Type
- 30,000 hrs Lifespan

3 YEAR WARRANTY*

MODEL	WATTS	LUMENS	BOX QTY.	SKU: 816 4000K DAY WHITE
VT-11	10w	720	10 pcs	

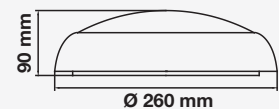

MODEL	WATTS	LUMENS	BOX QTY.	SKU: 806 4000K DAY WHITE
VT-17	17w	1400	10 pcs	

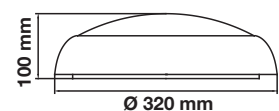

2D Bulkhead with Sensor



This range of LED bulkheads are recommended for purposes of increasing security in garages, walkways, and parking areas. With competitive detection range and dimmable functions, these bulkheads exhibit exceptional performance in outdoor security lighting.

- **AC:200-240V,50/60Hz**
- **120° / 360° Detection Angle**
- **3m, 5m, 8m, 10m (optional) Detection Distance**
- **Max D10Mx4M Detection Range**
- **10S, 1min, 5min, 10min customized Hold Time**
- **Day, 10Lux, 30Lux, 50Lux optional Day light Sensor**
- **Yes, 0, 10%, 20%, 30% optional Dimmable Function**
- **0.5~3m/s Detection Motion Speed**
- **PC Body type**
- **>3 hrs Emergency Operation time**
- **SMD LED Type**
- **30,000 hrs Lifespan**

5 YEAR WARRANTY*

MODEL	WATTS	LUMENS	BOX QTY.
VT-09	8w	720	10 pcs

SKU: 818 | 4000K DAY WHITE

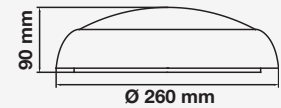

MODEL	WATTS	LUMENS	BOX QTY.
VT-16	15w	1400	10 pcs

SKU: 803 | 3000K WARM WHITE
SKU: 804 | 4000K DAY WHITE
SKU: 805 | 6400K WHITE

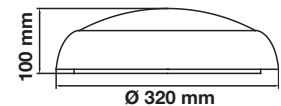

MODEL	WATTS	LUMENS	BOX QTY.
VT-22	15w	1450l	10 pcs

SKU: 819 | 4000K DAY WHITE

 **VANDAL-PROOF**

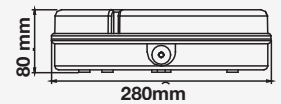



2D Bulkhead with Emergency Battery Backup and Sensor

3in1 Bulkhead
 Emergency Battery Backup
 Microwave Sensor

Our 3-in-1 LED bulkhead range is equipped with the complete package for a remarkable and reliable indoor/outdoor emergency and security lighting. With reliable Ni-Cad emergency battery back up, advanced microwave sensor, and optional dimmable functions, this range has impressive lighting abilities to make outdoor locations of residential, business, and industrial areas safer and easier to navigate.

- **AC:200-240V,50/60Hz**
- **>1.2 Watts Emergency Standby Watts**
- **60mA Battery Charging Current**
- **200mA Battery Discharging Current**
- **Ni-CD AA, 7.2V 1.0Ah Battery Type**
- **Green LED Charging indicate**
- **Including battery protection circuit & inhibiting mode**
- **120° / 360° Detection Angle**
- **Yes, 0, 10%, 20%, 30% optional Dimmable Function**
- **0.5~3m/s Detection Motion Speed**
- **PC Body type**
- **>3 hrs Emergency Operation time**
- **SMD LED Type**
- **3m, 5m, 8m, 10m (optional) Detection Distance**
- **30,000 hrs Lifespan**

3 YEAR
WARRANTY*

MODEL	WATTS	LUMENS	BOX QTY.
VT-12	10w	720	10 pcs

SKU: 817 | 4000K DAY WHITE

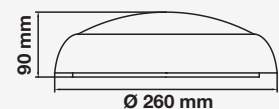

MODEL	WATTS	LUMENS	BOX QTY.
VT-19	17w	1400	10 pcs

SKU: 812 | 4000K DAY WHITE

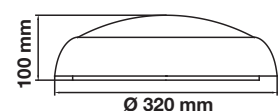

EMERGENCY
BATTERY
BACKUP 

MICROWAVE
SENSOR

31 IN EMERGENCY BATTERY BACKUP
MICROWAVE SENSOR

 **IP65**
RATING



SLIM DOMELIGHT

A new addition to our Dome Light Lights series, V-TAC's new Slim IP65 LED Dome Lights are re-designed with a sleeker, more compact built for a modern look – perfect lighting for outdoor areas in residential, business, and industrial zones.

Slim Domelight

- AC:220-240V,50/60Hz
- 110° Beam Angle
- SMD LED chip type
- Body Material - PC
- 30,000 Life Hours
- CRI >80
- IP Rating IP65

5 YEAR
WARRANTY*

MODEL	WATTS	LUMENS	BOX QTY.	SKU: 935 3000K WARM WHITE
VT-12S	12w	1440	10 pcs	SKU: 820 4000K DAY WHITE
				SKU: 936 6400K DAY WHITE

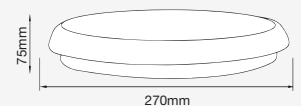

Slim Domelight with Emergency Backup

- AC:220-240V,50/60Hz
- 110° Beam Angle
- SMD LED chip type
- Body Material - PC
- 30,000 Life Hours
- CRI >80
- IP Rating IP65
- > 3 Hours emergency operation time
- Battery type -Ni-Cd 9.6V,1.0Ah
- Battery Charging Current - 60mA
- Battery Discharge Current - 200mA

3 YEAR WARRANTY*

 **Emergency Battery Backup**

MODEL	WATTS	LUMENS	BOX QTY.	SKU: 822 4000K DAY WHITE
VT-12SE	14w	1440	10 pcs	

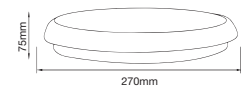

Slim Domelight with Sensor

- AC:220-240V,50/60Hz
- 110° Beam Angle
- SMD LED chip type
- Body Material - PC
- 30,000 Life Hours
- CRI >80
- IP Rating IP54
- Microwave Sensor
- 3-6m detection distance
- 10mx6m detection range
- 360°Ceiling/120°Wall Mounted
- Detection Motion Speed - 0.5-3m/s
- Hold Time - 30s, 40s, 50s customized
- Daylight sensor -Day, 2lux, 10lux, 50lux optional
- Dimmable - Yes, 0, 10%,20% optional
- Manual Override by dial switch
- Stand by period - 0s, 10s, 10m optional

5 YEAR WARRANTY*

 **Microwave Sensor**

MODEL	WATTS	LUMENS	BOX QTY.	SKU: 937 3000K WARM WHITE SKU: 821 4000K DAY WHITE SKU: 938 6400K DAY WHITE
VT-12SS	12w	1440	10 pcs	

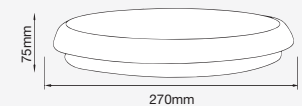

Slim Domelight with Emergency+Sensor

- AC:220-240V,50/60Hz
- 110° Beam Angle
- SMD LED chip type
- Body Material - PC
- 30,000 Life Hours
- CRI >80
- IP Rating IP54
- > 3 Hours emergency operation time
- Battery type -Ni-Cd 9.6V,1.0Ah
- Battery Charging Current - 60mA
- Battery Discharge Current - 200mA
- Microwave Sensor
- 3-6m detection distance
- 10mx6m detection range
- 360°Ceiling/120°Wall Mounted
- 0.5-3m/s detection motion speed
- 30s, 40s, 50s customized (time delay)
- Daylight sensor -Day: 7-20LUX
- Dimmable - Yes, 0, 10%,20% optional
- Manual Override
- Standby - 0s, 10s, 10m optional

3 YEAR WARRANTY*

 **3in1**
Bulkhead
Emergency Battery Backup
Microwave Sensor

MODEL	WATTS	LUMENS	BOX QTY.	SKU: 823 4000K DAY WHITE
VT-12SES	14w	1440	10 pcs	

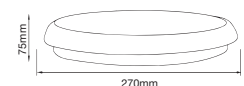



Bulkhead CCT Changeable With Switch

Our resilient IP65 LED bulkheads make a good choice for outdoor residential, business, and industrial areas that need constant lighting since they can withstand weather, dust. This new model has an easy switch for colour temperature tuning to achieve any lighting mood in any room. No need to worry about which colour temperature for any room when you can have it all – readily available with just a flick of a switch.

- AC:200-240V,50/60Hz
- CRI >80
- 30,000 Life Hours
- 120° Beam Angle
- PC Material
- Built in Switch for CCT Changing

EASY TOGGLE SWITCH



3000K 4000K 6400K

EASY ACCESS FOR
 COLOR CHANGING
 WITH BUTTON



MODEL	WATTS	LUMENS	BOX QTY.
VT-2-17	15w	1400	10 pcs

SKU: 20016 | 3 IN 1

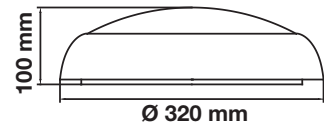



Domelight - Sensor

- Input: AC: 110-240V, 50/60Hz
- 120° Beam Angle
- 20,000 Hours
- SMD LED Chip
- CRI >80
- 3 year warranty
- Detection Distance - 6m Max
- Detection Range - 360°
- Time Delay - Min-10sec±3sec, Max-3min±30sec
- Detection motion Speed - 0.6-1.5m/s
- Ambient Light - <3-2000lux(adjustable)
- Instant start
- IP20 Rating

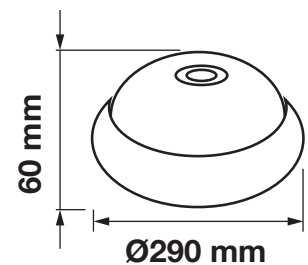

MODEL	WATTS	LUMENS	BOX QTY.
VT-13	12w	800	10 pcs

- SKU: 807 | 3000K WARM WHITE
- SKU: 808 | 4000K DAY WHITE
- SKU: 809 | 6400K WHITE

NEW

V-TAC[®]
GENERATION



120
LM/WATT

Ceiling Light-Round

- AC:100-240V,50/60Hz
- IP Rating:IP44
- CRI:>80
- Warranty:3 Years
- 110° Beam Angle
- Body Type: PC

3 YEAR
WARRANTY*



MODEL	WATTS	LUMENS	BOX QTY.
VT-8033RD	15w	1800	20 pcs

SKU: 13889 | 3000K WARM WHITE
SKU: 55669 | 4000K DAY WHITE
SKU: 13899 | 6500K WHITE

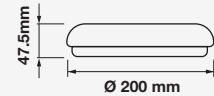

MODEL	WATTS	LUMENS	BOX QTY.
VT-8066RD	25w	3000	10 pcs

SKU: 13929 | 3000K WARM WHITE
SKU: 13939 | 4000K DAY WHITE
SKU: 13949 | 6500K WHITE

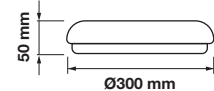

NEW

V-TAC[®]
GENERATION



120
LM/WATT

Ceiling Light-Square

- AC:100-240V,50/60Hz
- IP Rating:IP44
- CRI:>80
- Warranty:3 Years
- 110° Beam Angle
- Body Type: PC

3 YEAR
WARRANTY*



MODEL	WATTS	LUMENS	BOX QTY.
VT-8033SQ	15w	1800	20 pcs

SKU: 13909 | 3000K WARM WHITE
SKU: 55679 | 4000K DAY WHITE
SKU: 13919 | 6500K WHITE



MODEL	WATTS	LUMENS	BOX QTY.
VT-8066SQ	25w	3000	10 pcs

SKU: 13959 | 3000K WARM WHITE
SKU: 13969 | 4000K DAY WHITE
SKU: 13979 | 6500K WHITE

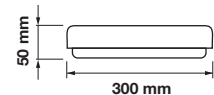



Reflector Downlight

Our new reflector downlights feature a quick connector for easy wiring and installation. The beam angle direction can be also be easily adjusted by tilting the downlight itself.

- **Adjustable Angle**
- **AC:85-265V,50/60Hz**
- **Body type Aluminium**
- **120° Beam Angle**
- **LED (COB chip) provided by Samsung**
- **CRI >80**

MODEL	WATTS	LUMENS	BOX QTY.
VT-2-10	10w	900	40 pcs

SKU: 839 | 3000K WARM WHITE
 SKU: 840 | 4000K DAY WHITE
 SKU: 841 | 6400K WHITE

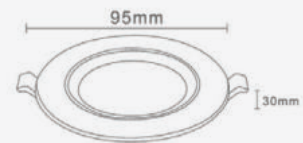

Cutting Size: \varnothing 80mm

MODEL	WATTS	LUMENS	BOX QTY.
VT-2-20	20w	1600	20 pcs

SKU: 842 | 3000K WARM WHITE
 SKU: 843 | 4000K DAY WHITE
 SKU: 844 | 6400K WHITE

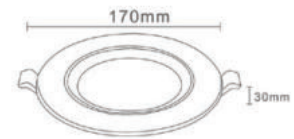

Cutting Size: \varnothing 145 mm

MODEL	WATTS	LUMENS	BOX QTY.
VT-2-30	30w	2400	10 pcs

SKU: 845 | 3000K WARM WHITE
 SKU: 846 | 4000K DAY WHITE
 SKU: 832 | 6400K WHITE



Cutting Size: \varnothing 195 mm



UGR <19



12°
Narrow Beam Angle

38°
Narrow Beam Angle

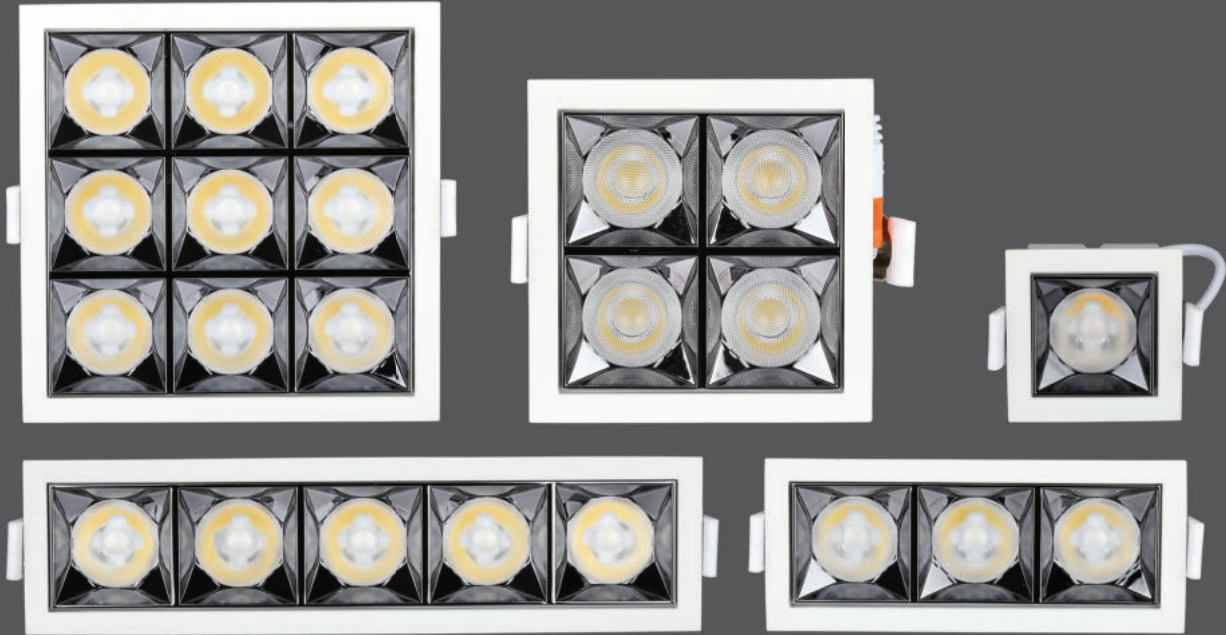

Reflector Downlight

Introducing V-TAC's LED reflector downlights — available in 12° & 38° beam angles & CRI rating of >90, to achieve any residential, retail, or hospitality lighting need.

- 30,000 Life Hours
- Input Voltage - AC:220-240V,50Hz
- Body Material - Aluminium
- Includes Quick Connector for easy wiring



MODEL
VT-2-04 12°

SKU: 972 | 2700K WARM WHITE
SKU: 971 | 4000K DAY WHITE
SKU: 970 | 5700K WHITE

WATTS	LUMENS	BOX QTY.
4w	320	100 pcs

MODEL
VT-2-04-1 38°

SKU: 987 | 2700K WARM WHITE
SKU: 986 | 4000K DAY WHITE
SKU: 985 | 5700K WHITE

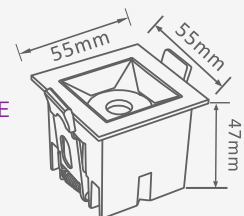

Cutting Size



MODEL
VT-2-12 12°

SKU: 975 | 2700K WARM WHITE
SKU: 974 | 4000K DAY WHITE
SKU: 973 | 5700K WHITE

WATTS	LUMENS	BOX QTY.
12w	960	50 pcs

MODEL
VT-2-12-1 38°

SKU: 990 | 2700K WARM WHITE
SKU: 989 | 4000K DAY WHITE
SKU: 988 | 5700K WHITE

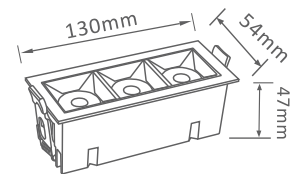

Cutting Size

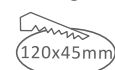



MODEL
VT-2-16

12°

SKU: 978 | 2700K WARM WHITE
 SKU: 977 | 4000K DAY WHITE
 SKU: 976 | 5700K WHITE

WATTS	LUMENS	BOX QTY.
16w	1280	50 pcs

MODEL
VT-2-16-1

38°

SKU: 993 | 2700K WARM WHITE
 SKU: 992 | 4000K DAY WHITE
 SKU: 991 | 5700K WHITE

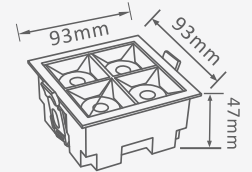

Cutting Size

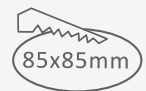

MODEL
VT-2-21

12°

SKU: 981 | 2700K WARM WHITE
 SKU: 980 | 4000K DAY WHITE
 SKU: 979 | 5700K WHITE

WATTS	LUMENS	BOX QTY.
20w	1600	20 pcs

MODEL
VT-2-21-1

38°

SKU: 996 | 2700K WARM WHITE
 SKU: 995 | 4000K DAY WHITE
 SKU: 994 | 5700K WHITE

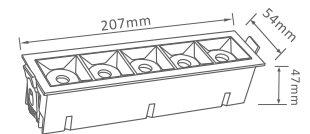

Cutting Size

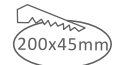

MODEL
VT-2-36

12°

SKU: 984 | 2700K WARM WHITE
 SKU: 983 | 4000K DAY WHITE
 SKU: 982 | 5700K WHITE

WATTS	LUMENS	BOX QTY.
36w	2880	20 pcs

MODEL
VT-2-36-1

38°

SKU: 999 | 2700K WARM WHITE
 SKU: 998 | 4000K DAY WHITE
 SKU: 997 | 5700K WHITE

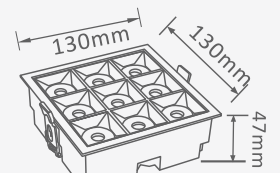

Cutting Size



**SAMSUNG
LED**

Illuminated

**5
YEAR
WARRANTY***

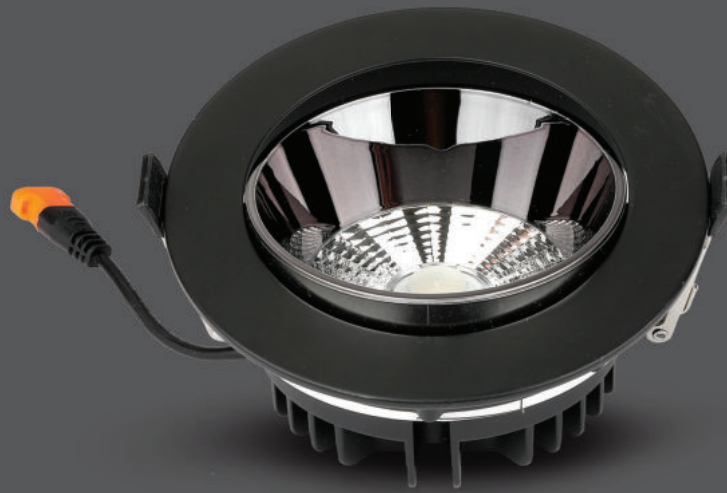

Reflector Downlight - Black Housing

Introducing V-TAC's LED reflector downlights with black housing—available in 10w, 20w & 30w & CRI rating of >80, to achieve any residential, retail, or hospitality lighting need.

- AC:85-265V,50/60Hz
- CRI >80
- 30,000 Life Hours
- 120° Beam Angle
- 85% Energy Saving

MODEL
VT-2-13

NEW

SKU: 20051 | 3000K WARM WHITE
SKU: 20052 | 4000K DAY WHITE
SKU: 20053 | 6400K WHITE

WATTS	LUMENS	BOX QTY.
10w	800	40 pcs

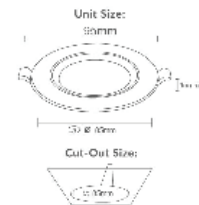

MODEL
VT-2-23

NEW

SKU: 20054 | 3000K WARM WHITE
SKU: 20055 | 4000K DAY WHITE
SKU: 20056 | 6400K WHITE

WATTS	LUMENS	BOX QTY.
20w	1600	20 pcs

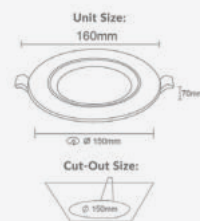

MODEL
VT-2-33

NEW

SKU: 20057 | 3000K WARM WHITE
SKU: 20058 | 4000K DAY WHITE
SKU: 20059 | 6400K WHITE

WATTS	LUMENS	BOX QTY.
30w	2400	10 pcs

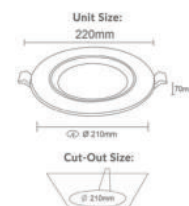

**SAMSUNG
LED**

Illuminated

**5 YEAR
WARRANTY***



LED Downlight

Our new reflector downlights feature adjustable beam angle direction. CRI rating of >90, to achieve any residential, retail, or hospitality lighting need.

- Adjustable Angle
- AC:220-240V,50/60Hz
- 24° Beam Angle
- IP20
- 30,000 Life Hours



VT-419

NEW

SKU: 20049 | 4000K DAY WHITE

WATTS	LUMENS	BOX QTY.
18w	1450	20 pcs

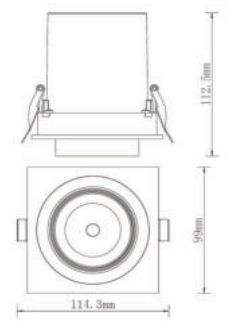

VT-436

NEW

SKU: 20050 | 4000K DAY WHITE

WATTS	LUMENS	BOX QTY.
2x18w	2900	10 pcs

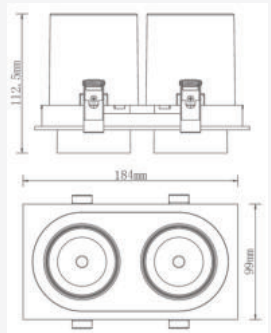



5 YEAR
 WARRANTY*

Fire Rated Downlight

Our new Fire-Rated Spotlight Fittings are available in Chrome, Nickel, and White finish. With 3000K, 4000K and 6400K CCT options, built with Aluminium alloy and iron. Efficient replacement for traditional downlight fittings.

- 70° Beam Angle
- IP rating IP65
- Iron+Aluminium Alloy
- CRI >80
- LED provided by Samsung
- 30,000 Hours



30-60-90 MIN
Fire Rated



QUICK
CONNECTOR



DIMMABLE
LIGHT CONTROL

MODEL	WATTS	LUMENS	COLOR	BOX QTY.	SKU: 8175 3000K WARM WHITE
VT-885-C	5w	500	Chrome	60 pcs	SKU: 8176 4000K DAY WHITE SKU: 8180 6400K WHITE



Cutting Size: Ø57mm

MODEL	WATTS	LUMENS	COLOR	BOX QTY.	SKU: 8173 3000K WARM WHITE
VT-885-N	5w	500	Nickel	60 pcs	SKU: 8174 4000K DAY WHITE SKU: 8179 6400K WHITE



Cutting Size: Ø57mm

MODEL	WATTS	LUMENS	COLOR	BOX QTY.	SKU: 8177 3000K WARM WHITE
VT-885-W	5w	500	White	60 pcs	SKU: 8178 4000K DAY WHITE SKU: 8181 6400K WHITE



Cutting Size: Ø57mm

Fire Rated Downlight-3PC Pack



30-60-90 MIN
Fire Rated



QUICK
CONNECTOR



DIMMABLE
LIGHT CONTROL

MODEL	WATTS	LUMENS	COLOR	BOX QTY.	SKU: 8874 3000K WARM WHITE
VT-885-C	5w	500	Chrome	20 pcs	SKU: 8875 4000K DAY WHITE
					SKU: 8876 6400K WHITE

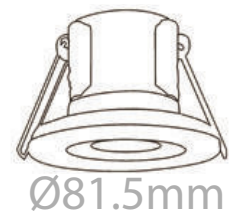

Cutting Size: Ø57mm

MODEL	WATTS	LUMENS	COLOR	BOX QTY.	SKU: 8197 3000K WARM WHITE
VT-885-N	5w	500	Nickel	20 pcs	SKU: 8198 4000K DAY WHITE
					SKU: 8199 6400K WHITE

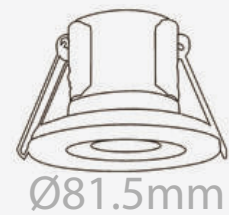

Cutting Size: Ø57mm

MODEL	WATTS	LUMENS	COLOR	BOX QTY.	SKU: 8182 3000K WARM WHITE
VT-885-W	5w	500	White	20 pcs	SKU: 8183 4000K DAY WHITE
					SKU: 8184 6400K WHITE

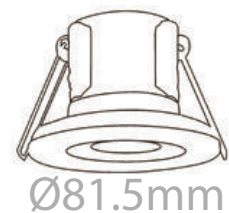

Cutting Size: Ø57mm

NEW

Fire Rated Downlight-10PC Pack



10
PCS PACK



30-60-90 MIN
Fire Rated



QUICK
CONNECTOR



DIMMABLE
LIGHT CONTROL

MODEL	WATTS	LUMENS	COLOR	BOX QTY.	SKU: 8913 3000K WARM WHITE
VT-885-C	5w	500	Chrome	6 pcs	SKU: 8914 4000K DAY WHITE SKU: 8915 6400K WHITE

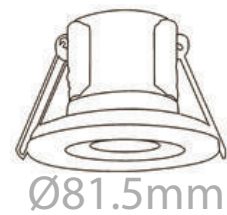

Cutting Size: Ø57mm

MODEL	WATTS	LUMENS	COLOR	BOX QTY.	SKU: 8890 3000K WARM WHITE
VT-885-N	5w	500	Satin Nickle	6 pcs	SKU: 8891 4000K DAY WHITE SKU: 8912 6400K WHITE

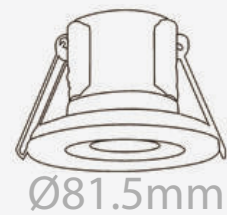

Cutting Size: Ø57mm

MODEL	WATTS	LUMENS	COLOR	BOX QTY.	SKU: 8887 3000K WARM WHITE
VT-885-W	5w	500	White	6 pcs	SKU: 8888 4000K DAY WHITE SKU: 8889 6400K WHITE

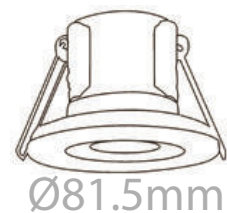

Cutting Size: Ø57mm



Included Bezels



Chrome

Satin Nickle

White

Fire Rated Downlight

An innovative addition to our Fire-Rated Downlight series, this new model has an accessible switch for colour temperature tuning so users can easily achieve any lighting mood in any room.

- IP65 Rating.
- Integrated SMD LED (Non-replaceable).
- Isolate driver with terminal for easy and speedy installation
- Dimmable
- AC:200-240V,50Hz
- Body Type: Aluminium
- 60° Beam Angle
- CRI >80
- LED provided by samsung
- 30,000 Hours
- Cutting size:75mm

30 MIN
60 MIN
90 MIN
Fire Rated

EASY TOGGLE SWITCH



3000K 4000K 6400K

EASY ACCESS FOR COLOR CHANGING WITH BUTTON



MODEL	WATTS	LUMENS	BOX QTY.	SKU: 881 3IN1
VT-18D	8w	720	30 pcs	

(When light intensity is more than 10 lx, light keep off even though people in. Less than 10 lx, PIR Sensor works)

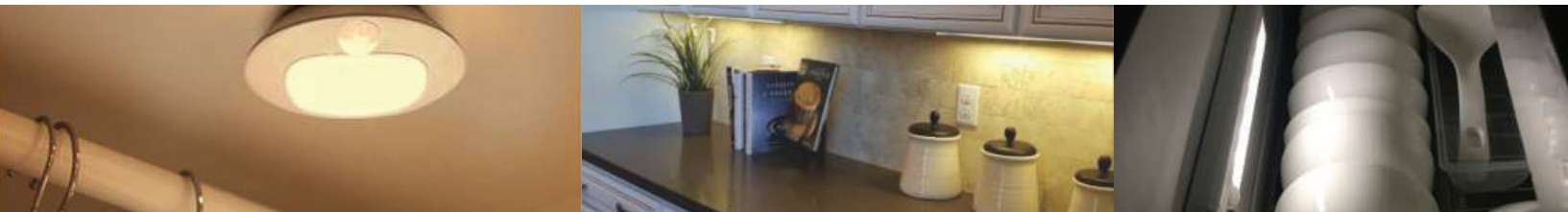
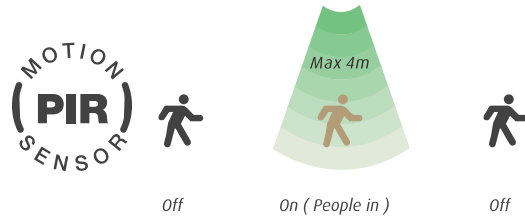

LED CABINET LIGHT

Enjoy the convenience of V-TAC's new LED cabinet lights with built-in PIR sensor. Ideal for wardrobes, bookshelves, drawers, and tool cabinets. Fully powered by batteries, designed for a neat installation.

- **Easy to mount**
- **Automatic sensing**
- **Uses battery instead of power supply, no wires**
- **Ideal for wardrobes, bookcases, cupboards, and more...**

2 YEAR
WARRANTY*

VT-80

SKU: 813 | 4000K DAY WHITE

WATTS	LUMENS	BOX QTY.
1.5w	80	50 pcs

3xAAA (Battery not included)

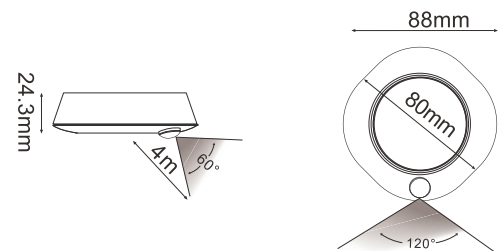

VT-81

SKU: 814 | 4000K DAY WHITE

WATTS	LUMENS	BOX QTY.
1.5w	135	50 pcs

4xAA (Battery not included)

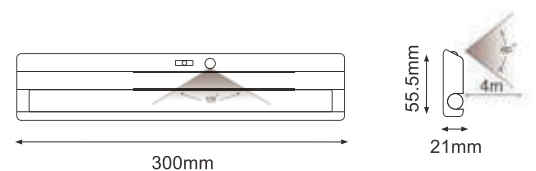

LED Night Light

Eye-friendly LED night light, produce comforting gentle warm light to let you see better in the dark. This white LED nightlight can illuminate any dark space in your home or office.

- **Voltage/Frequency:** 220-240V, 50Hz
- **Power:** 0.45W
- **RA:** >80
- **Body material:** ABS+PC
- **Box Qty:** 50pcs



VT-82RD

SKU: 824 | 3000K WARM WHITE
 SKU: 825 | 4000K DAY WHITE

SIZE
 ø65x55mm

VT-82SQ

SKU: 826 | 3000K WARM WHITE
 SKU: 827 | 4000K DAY WHITE

SIZE
 65x55mm

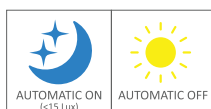

VT-83RD

SKU: 828 | 3000K WARM WHITE
 SKU: 829 | 4000K DAY WHITE

SIZE
 ø60x54.5mm

VT-83SQ

SKU: 830 | 3000K WARM WHITE
 SKU: 831 | 4000K DAY WHITE

SIZE
 60x60x54.5mm

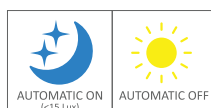

USB charging ports to charge USB chargeable devices simultaneously

VT-84RD

SKU: 505 | 3000K WARM WHITE
 SKU: 506 | 4000K DAY WHITE

SIZE
 ø60x54.5mm

VT-84SQ

SKU: 507 | 3000K WARM WHITE
 SKU: 508 | 4000K DAY WHITE

SIZE
 60x60x54.5mm

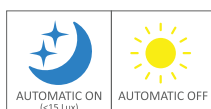

VT-86RD

SKU: 20018 | 3000K WARM WHITE
 SKU: 20017 | 4000K DAY WHITE

SIZE
 ø65x50mm

VT-86SQ

SKU: 20019 | 3000K WARM WHITE
 SKU: 20020 | 4000K DAY WHITE

SIZE
 65x65x50mm



NEW

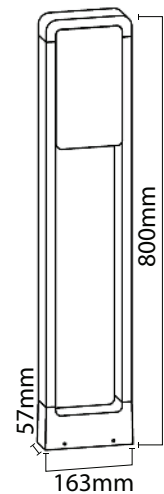

LED BOLLARD LIGHTS

- Input AC:220-240V,50/60Hz
- CRI >80
- PF >0.5
- 120° Beam Angle
- 20,000 Life Hours
- IP65 Protection
- LED Chip Type - SMD
- On/Off Cycle - 15,000

3 YEAR
WARRANTY*



IP65
RATING



VT-33-WHITE

- SKU: 20116 | 3000K WARM WHITE
- SKU: 20117 | 4000K DAY WHITE
- SKU: 20118 | 6400K WHITE

WATTS	LUMENS	BOX QTY.
10W	900	5 pcs

LUMINOUS INTENSITY DISTRIBUTION DIAGRAM

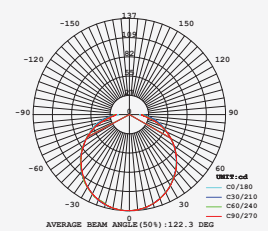

VT-33-BLACK

- SKU: 20113 | 3000K WARM WHITE
- SKU: 20114 | 4000K DAY WHITE
- SKU: 20115 | 6400K WHITE

WATTS	LUMENS	BOX QTY.
10W	650	5 pcs

LUMINOUS INTENSITY DISTRIBUTION DIAGRAM

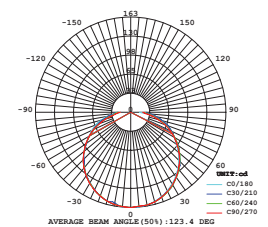

LED Solar Wall and Bollard Lights

- Min 3hrs / Max 12hrs Working Time
- IP65 Rating
- AL+PC Material
- Lithium battery 3.7V 2600mAh
- 3-5 meters Sensing Range
- 4-6 hours sunlight charging Time
- 2Watts
- 50pcs of LED
- 5.5V 3 W Solar Panel

VT-77

SKU: 784 | 3000K WARM WHITE

LUMENS BEAM ANGLE

220 **170°**

BOX QTY. SIZE

10 pcs **140x140x290mm**



VT-66

SKU: 785 | 3000K WARM WHITE

LUMENS BEAM ANGLE

280 **120°**

BOX QTY. SIZE

10 pcs **140x140x500mm**



LED Wall Light



VT-7-06

SKU: 780 | 3000K WARM WHITE

SKU: 781 | 4000K DAY WHITE

WATTS LUMENS BEAM ANGLE BOX QTY. SIZE

10w **800** **110°** **20 pcs** **300x55x194mm**



- AC220-240V,50/60Hz
- CRI: >80
- 15,000 times On/Off
- 20,000 hrs. Life span
- PC Material
- IP54 Rating



LED EMERGENCY LIGHTS

V-TAC new range of LED emergency lights comes at an age of increased awareness and standards for safety compliance in different infrastructures. Now equipped with highly efficient LEDs provided by Samsung, these emergency lights include clear-cut exit signs, and are powered by high performance batteries, to provide a longer lifespan, lower maintenance, with increased working time when activated.

V-TAC's emergency lights are a smart choice for effective emergency lighting to meet fire & safety assessments in residential and commercial buildings, offices, hotels, hospitals, and schools

APPLICATION

Offices, hospitals, corporate buildings, schools, and commercial establishments





KEY FEATURES

- Thermoplastic PC built
- High quality Ni-Cd batteries made for longevity & low maintenance reliable emergency backup of 3 hours
- Rectangular type plastic with different signs for various locations
- Single or double face configuration
- Wall, side, or ceiling mounted
- LED indicator light and push button test switch LEDs mounted on print circuit board
- 12-24-hour recharge after more than 3-hour discharge
- Efficient thermal management technology
- Corrosion-free mounting clamps
- Maintained operation mode

Exit Light - Surface

VT-519-S-12 SKU: 836 - 6000K WHITE

Box Qty: 10pcs

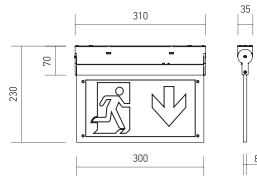

Lumens:	140lm	Viewing Distance:	24 Meters From Both Sides
IP Rating:	IP20	Test Button:	Green Light Indicator Test Button
Material :	PC	Legends:	3 Way Legend Available
Exit Lamp Type:	Wall/Ceiling	Input Voltage:	AC:220-240V,50/60Hz
Battery:	Ni-Cd 3.6V,900mAh	Mode Of Operation:	Maintained
Recharging Time:	12 Hours	Emergency Operation Time:	>3 Hours
Stickers:	3 Stickers	Lamp Type:	16 SMD LEDs
Watts:	2w		

Exit Light-Recessed

VT-522-S-12 SKU: 835 - 6000K WHITE

Box Qty: 10pcs

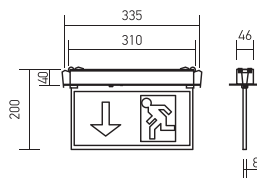

Lumens:	140lm	Viewing Distance:	24 Meters From Both Sides
IP Rating:	IP20	Test Button:	Green Light Indicator Test Button
Material :	PC	Legends:	3 Way Legend Available
Exit Lamp Type:	Recessed/Ceiling	Input Voltage:	AC:220-240V,50/60Hz
Battery:	Ni-Cd 3.6V,900mAh	Mode Of Operation:	Maintained
Recharging Time:	12 Hours	Emergency Operation Time:	>3 Hours
Stickers:	3 Stickers	Lamp Type:	16 SMD LEDs
Watts:	2w		

Exit Light - Bulkhead

VT-511-S SKU: 899 - 6000K WHITE

Box Qty: 10 Pcs

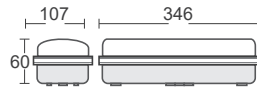

Lumens: 110lm
 IP Rating: IP20
 Material: ABS+PC
 Exit Lamp Type: Bulkhead
 Watts: 3.8w

Input Voltage:
 Mode Of Operation:
 Emergency Operation Time:
 Lamp Type:
 Battery:
 Recharging Time:

AC:220-240V,50/60Hz
 Maintained/Non Maintained
 >3 Hours
 20 SMD LEDs
 4V2.0AH Lead Acid battery
 12 Hours

Exit Light - Bulkhead

VT-524-S-12 SKU: 838 - 6000K WHITE

Box Qty: 12pcs

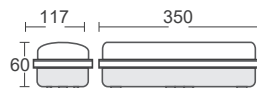

Lumens: 190lm
 IP Rating: IP65
 Material: PC
 Exit Lamp Type: Wall - Bulkhead
 Battery: Ni-Cd 4.8V,900mAh
 Recharging Time: 12 Hours
 Stickers: 3 Stickers
 Watts: 4w

Viewing Distance:
 Test Button:
 Legends:
 Input Voltage:
 Mode Of Operation:
 Emergency Operation Time:
 Lamp Type:

22 Meters From One side
 Green Light Indicator Test Button
 3 Way Legend Available
 AC:220-240V,50/60Hz
 Maintained
 >3 Hours
 30 SMD LEDs



LED STRIP LIGHTS

V-TAC's efficient LED strip lights is an effective solution to light up tight spaces, or in simply decorating your kitchen, bedroom, and even your garden. Applicable both for accent lighting or task lighting, these strip lights are easy to install, compatible with controls, and are available in standard color temperatures.

APPLICATION

Recommended for bedrooms, kitchens, restaurants, bars, and other residential and commercial areas





KEY FEATURES

- Easy installation
- Available in 5m and 10m
- Exceptionally low power consumption

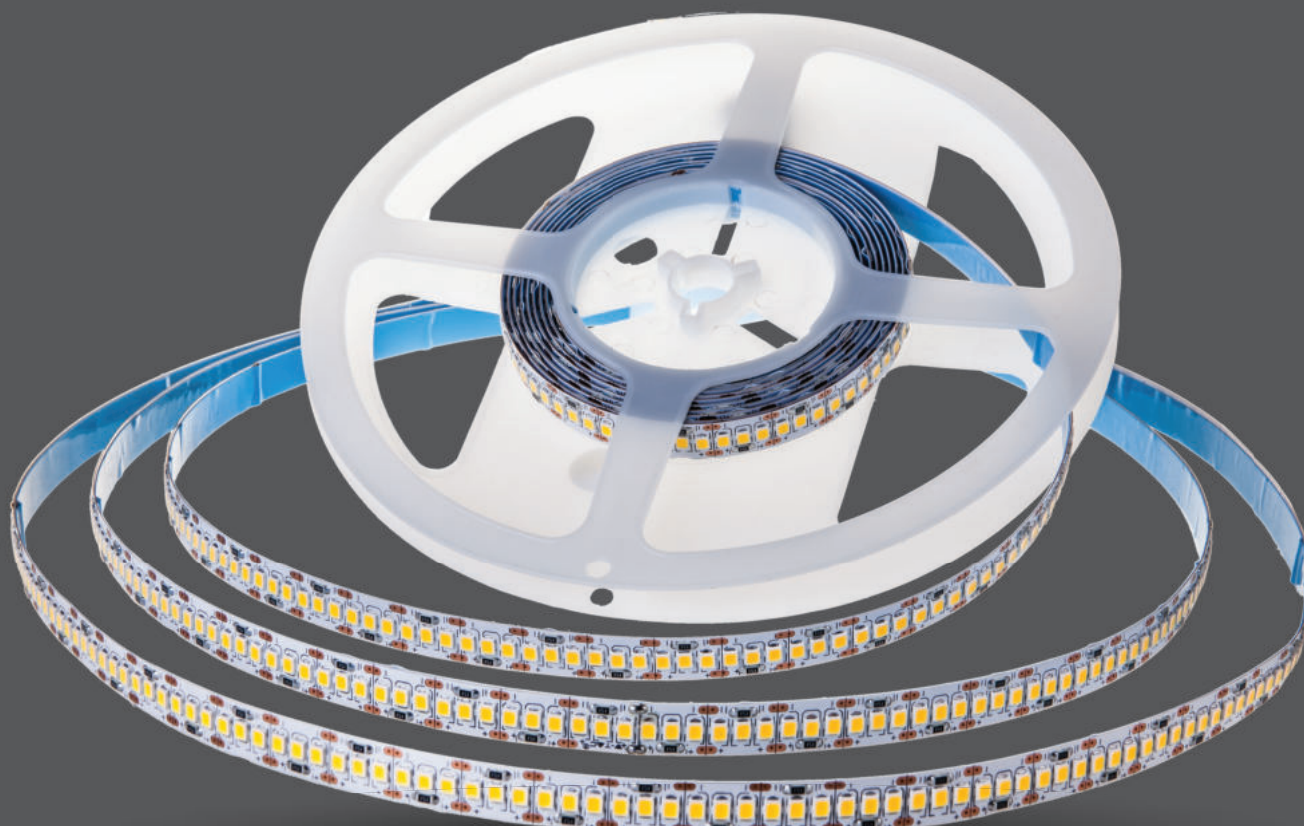

LED STRIP & NEON FLEX LIGHTS

This range includes up to 18 watt dust and moisture-rated LED strip lights, equipped with Samsung LED Chips for an even further advanced and vivid performance. It also has our IP65 neon flex LED strip light that is specially designed for outdoor resistance. Available in 3000K Warm White, 4000K Day White, and 6400K White, we have the optimal range of low-energy consuming and easy-to-install strip lights with vibrant lighting.

- LED strip is a low voltage flexible ribbon available in 24v and 12V
- Flexible & easy installation
- Exceptionally low power consumption
- Multiple visual effects in unending colours and shades

3 YEAR WARRANTY*

CRI>95

MODEL	WATTS	LUMENS	VOLTAGE	BOX QTY.	SKU: 331 3000K WARM WHITE
VT-10-240-1	18w	1800	DC:24V	40 Packets	SKU: 332 4000K DAY WHITE SKU: 333 6400K WHITE

10 METER ROLL

MODEL	WATTS	LUMENS	VOLTAGE	BOX QTY.	SKU: 320 3000K WARM WHITE SKU: 321 4000K DAY WHITE SKU: 322 6400K WHITE
VT-10-240	15w	1600	DC:24V	80 Packets	



MODEL	WATTS	LUMENS	VOLTAGE	BOX QTY.	SKU: 323 3000K WARM WHITE SKU: 324 4000K DAY WHITE SKU: 325 6400K WHITE
VT-5-120	12w	1200	DC:12V	80 Packets	



ULTRA THIN
 JUST 6 X 12MM

WATERPROOF LED NEON FLEX



MODEL	WATTS	LUMENS	VOLTAGE	BOX QTY.	SKU: 326 3000K WARM WHITE SKU: 327 4000K DAY WHITE SKU: 328 6400K WHITE
VT-55	10w	300	DC:12V	40 Packets	





LED SPOT LIGHTS

Our new range of LED spotlights with Samsung LEDs is your leading choice for efficient directional lighting solutions. This new range is perfectly compatible with existing GU10 holders. They deliver the same warm light as halogen spots while exhibiting the energy-saving benefits that LEDs provide. Ideal for retail and residential lighting.

APPLICATION

Ideal for lighting applications in residential, commercial, and hospitality locations.





KEY FEATURES

- Classic halogen-like design with up to 80% power savings
- Compatibility ensured: available in all existing spotlight holders
- Optional beam angles: ranging from 38°D to 300°D
- Set the right tone: dimmable options available

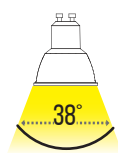
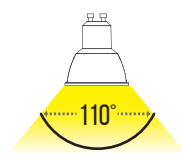

LED SPOTLIGHTS

LED Capsules Lights

Our newly improved range of capsule lights are the ideal choice for replacing Halogen counterparts. Now equipped with LEDs provided by Samsung for maximum efficiency.

- 30,000-hr lifespan
- DC: 12V for G4
- AC: 220-240V, 50Hz for G9
- CRI: >80

5 YEAR WARRANTY*



G4



G4



G9



G9

MODEL	WATTS	EQ.WATTS	LUMENS	BASE	BOX QTY.
VT-201	1.5w	10w	100	G4	200 pcs

- SKU: 240 | 3000K WARM WHITE
- SKU: 241 | 4000K DAY WHITE
- SKU: 242 | 6400K WHITE

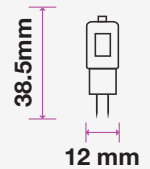
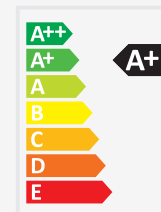

MODEL	WATTS	EQ.WATTS	LUMENS	BASE	BOX QTY.
VT-234	3.2w	30w	385	G4	200 pcs

- SKU: 131 | 3000K WARM WHITE
- SKU: 132 | 4000K DAY WHITE
- SKU: 133 | 6400K WHITE

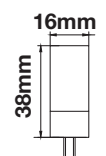
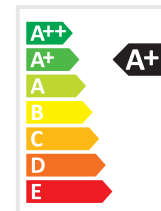

MODEL	WATTS	EQ.WATTS	LUMENS	BASE	BOX QTY.
VT-203	2.5w	20w	200	G9	200 pcs

- SKU: 243 | 3000K WARM WHITE
- SKU: 244 | 4000K DAY WHITE
- SKU: 245 | 6400K WHITE

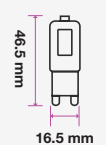
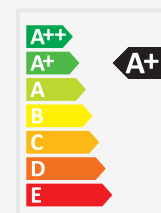

MODEL	WATTS	EQ.WATTS	LUMENS	BASE	BOX QTY.
VT-204	3w	25w	300	G9	200 pcs

- SKU: 246 | 3000K WARM WHITE
- SKU: 247 | 4000K DAY WHITE
- SKU: 248 | 6400K WHITE

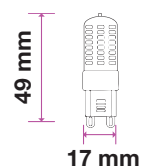
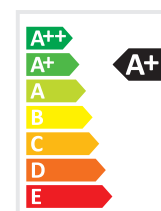

LED SPOTLIGHTS

LED GU10 Lights

Achieve a warm soft glow in any room with our improved range of GU10 spotlights with 30,000-hr lamp life.

- Clear and frost cover options
- Available in 38°D or 110°D beam angle
- Dimmable options available
- 30,000-hr lifespan
- DC: 12V for GU5.3
- AC: 220-240V, 50Hz for GU10
- CRI: >80

5 YEAR WARRANTY*



GU10



GU10



GU10

MODEL	WATTS	EQ.WATTS	LUMENS	BASE	BOX QTY.
VT-232	2w	15w	180	GU10	200 pcs

SKU: 869 | 3000K WARM WHITE
 SKU: 870 | 4000K DAY WHITE
 SKU: 871 | 6400K WHITE

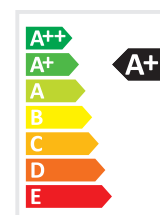

MODEL	WATTS	EQ.WATTS	LUMENS	BASE	BOX QTY.
VT-205	5w	35w	400	GU10	200 pcs

SKU: 201 | 3000K WARM WHITE
 SKU: 202 | 4000K DAY WHITE
 SKU: 203 | 6400K WHITE

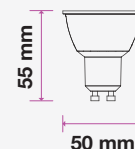
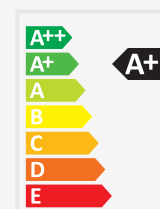

MODEL	WATTS	EQ.WATTS	LUMENS	BASE	SHAPE	BOX QTY.
VT-275	5w	40w	380	GU10		192 pcs

SKU: 108 | 3000K WARM WHITE
 SKU: 797 | 4000K DAY WHITE
 SKU: 511 | 6400K WHITE

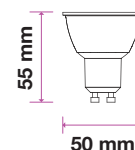
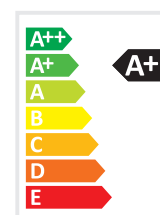

MODEL	WATTS	EQ.WATTS	LUMENS	BASE	SHAPE	BOX QTY.
VT-275D	5w	35w	380	GU10		192 pcs

SKU: 109 | 3000K WARM WHITE
 SKU: 512 | 4000K DAY WHITE
 SKU: 897 | 6400K WHITE

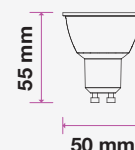
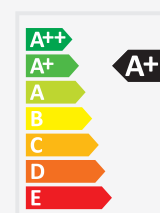

LED SPOT LIGHTS

LED SPOTLIGHTS
MR16 | GU10

5 YEAR
WARRANTY*



GU5.3



GU10

MODEL	WATTS	EQ.WATTS	LUMENS	BASE	BOX QTY.
VT-2335	5w	75	800	GU10	200 pcs
SKU: 2837 3000K WARM WHITE SKU: 2838 4000K DAY WHITE SKU: 2839 6400K WHITE					

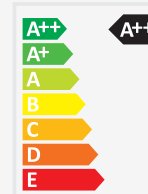

MODEL	WATTS	EQ.WATTS	LUMENS	BASE	BOX QTY.
VT-249	6w	50w	500	GU10	200 pcs
SKU: 20026 3000K WARM WHITE SKU: 20027 4000K DAY WHITE SKU: 20028 6400K WHITE					

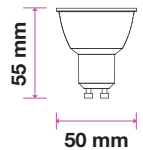
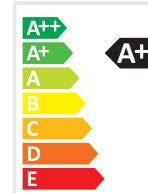

MODEL	WATTS	EQ.WATTS	LUMENS	BASE	BOX QTY.
VT-257	6.5w	55w	450	GU5.3	200 pcs
SKU: 204 3000K WARM WHITE SKU: 205 4000K DAY WHITE SKU: 206 6400K WHITE					

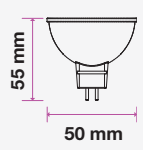
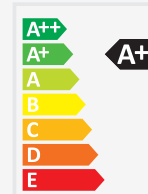

MODEL	WATTS	EQ.WATTS	LUMENS	BASE	BOX QTY.
VT-267	6.5w	40w	450	GU5.3	200 pcs
SKU: 207 3000K WARM WHITE SKU: 208 4000K DAY WHITE SKU: 209 6400K WHITE					

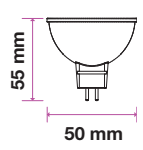
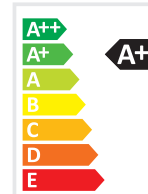

MODEL	WATTS	EQ.WATTS	LUMENS	BASE	BOX QTY.
VT-247	6.5w	60w	480	GU10	200 pcs
SKU: 192 3000K WARM WHITE SKU: 193 4000K DAY WHITE SKU: 194 6400K WHITE					

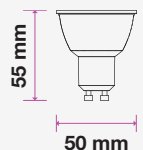
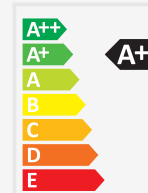

MODEL WATTS EQ.WATTS LUMENS BASE BOX QTY.
VT-247D **6.5w** **55w** **450** **GU10** **200 pcs**
 SKU: 198 | 3000K WARM WHITE
 SKU: 199 | 4000K DAY WHITE
 SKU: 200 | 6400K WHITE

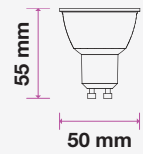
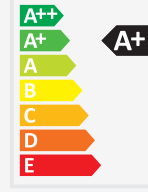

MODEL WATTS EQ.WATTS LUMENS BASE BOX QTY.
VT-227 **6.5w** **60w** **480** **GU10** **200 pcs**
 SKU: 189 | 3000K WARM WHITE
 SKU: 190 | 4000K DAY WHITE
 SKU: 191 | 6400K WHITE

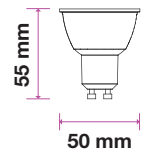
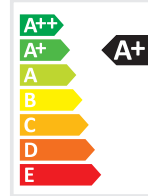

MODEL WATTS EQ.WATTS LUMENS BASE BOX QTY.
VT-227D **6.5w** **35w** **450** **GU10** **200 pcs**
 SKU: 195 | 3000K WARM WHITE
 SKU: 196 | 4000K DAY WHITE
 SKU: 197 | 6400K WHITE

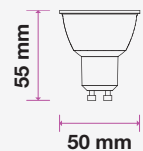
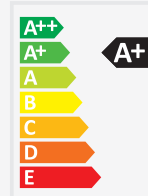

MODEL WATTS EQ.WATTS LUMENS BASE BOX QTY.
VT-277 **7w** **65w** **480** **GU10** **200 pcs**
 SKU: 165 | 3000K WARM WHITE
 SKU: 166 | 4000K DAY WHITE
 SKU: 167 | 6400K WHITE

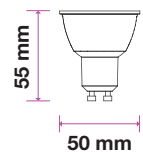
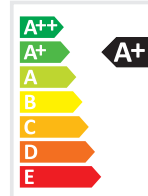

MODEL WATTS EQ.WATTS LUMENS BASE BOX QTY.
VT-291 **8w** **80w** **720** **GU10** **200 pcs**
 SKU: 875 | 3000K WARM WHITE
 SKU: 876 | 4000K DAY WHITE
 SKU: 877 | 6400K WHITE

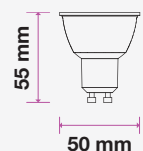
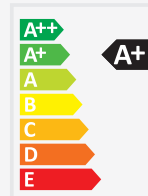

MODEL WATTS EQ.WATTS LUMENS BASE BOX QTY.
VT-292 **8w** **80w** **720** **GU10** **200 pcs**
 SKU: 872 | 3000K WARM WHITE
 SKU: 873 | 4000K DAY WHITE
 SKU: 874 | 6400K WHITE

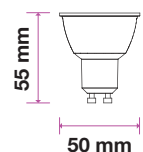
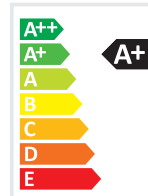

MODEL WATTS EQ.WATTS LUMENS BASE BOX QTY.
VT-271 **10w** **70w** **1000** **GU10** **200 pcs**
 SKU: 878 | 3000K WARM WHITE
 SKU: 879 | 4000K DAY WHITE
 SKU: 880 | 6400K WHITE

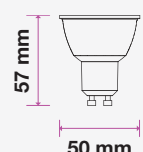
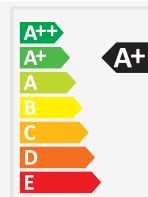



LED BULBS

Find the right bulb in V-TAC's newly improved range of LED bulbs. With our recent in-branding program with Samsung, all LED chips used in the PRO Series lamp range.

From aesthetically-pleasing filament bulbs to our extensive options of 360° omnidirectional thermoplastic bulbs in all sizes, watts, and lumens, we have a complete range to replace 60w to 150w traditional lamps for your home, office, or business.

APPLICATION

General lighting in residential, commercial, and industrial areas





KEY FEATURES

- Includes Amber & Clear Filament Bulbs, High-Lumen Bulbs, Thermoplastic Bulbs, Reflector Bulbs, PAR Bulbs, Big Bulbs, and B22s.
- Lightweight yet durable body: made of Aluminum + ASA plastic
- Designed with optimal thermal management
- 80% lower power consumption
- Dimmable options available
- 30,000-hr lifespan: remarkable performance than conventional and other LED lamps



LM/WATT



DIMMABLE



ENERGY RATING

A new milestone in our ceaseless approach towards **innovation**.

INTRODUCING THE NEW SERIES

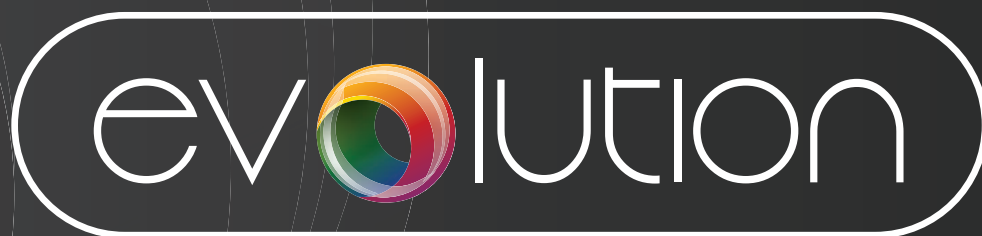

Our bestselling LED Bulbs — now upgraded with a superior efficiency of **160 lm/W** through the latest in LED technology.

*Super***BRIGHT**
160
LUMENS / W

NEW



Thermoplastic Bulb

6.5W VT-2307

SKU: 2806 - 3000K WARM WHITE
SKU: 2807 - 4000K DAY WHITE
SKU: 2808 - 6400K WHITE



5 YEAR WARRANTY

SuperBRIGHT
160
LUMENS/W

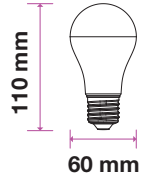
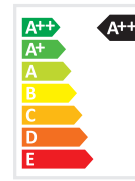

EQ. WATTS: 75w
VOLTAGE/FREQUENCY: AC:220-240V, 50Hz
LUMINOUS FLUX: 1055lm
COMMERCIAL TYPE: A60

LED TYPE: SMD
CRI: >80
PF: >0.6
BASE: E27

BEAM ANGLE: 200°
BODY TYPE: Thermoplastic
DIMENSION: 60x110mm
BOX QTY: 100

NEW



Thermoplastic Bulb

9.5W VT-2310

SKU: 2809 - 3000K WARM WHITE
SKU: 2810 - 4000K DAY WHITE
SKU: 2811 - 6400K WHITE



5 YEAR WARRANTY

SuperBRIGHT
160
LUMENS/W

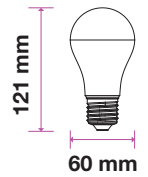
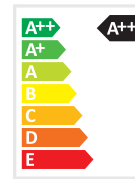

EQ. WATTS: 100w
VOLTAGE/FREQUENCY: AC:220-240V, 50Hz
LUMINOUS FLUX: 1521lm
COMMERCIAL TYPE: A60

LED TYPE: SMD
CRI: >80
PF: >0.6
BASE: E27

BEAM ANGLE: 200°
BODY TYPE: Thermoplastic
DIMENSION: 60x121mm
BOX QTY: 100

NEW



Thermoplastic Bulb

15W VT-2315

SKU: 2812 - 3000K WARM WHITE
SKU: 2813 - 4000K DAY WHITE
SKU: 2814 - 6400K WHITE



5 YEAR WARRANTY

SuperBRIGHT
160
LUMENS/W

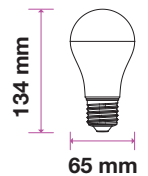

EQ. WATTS: 150w
VOLTAGE/FREQUENCY: AC:220-240V, 50Hz
LUMINOUS FLUX: 2500lm
COMMERCIAL TYPE: A65

LED TYPE: SMD
CRI: >80
PF: >0.6
BASE: E27

BEAM ANGLE: 200°
BODY TYPE: Thermoplastic
DIMENSION: 65x134mm
BOX QTY: 100

NEW



Clear Filament Bulb

24W VT-2324

SKU: 2816 - 4000K DAY WHITE
SKU: 2817 - 6400K WHITE



2 YEAR WARRANTY

SuperBRIGHT
160
LUMENS/W

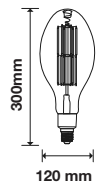
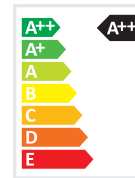

EQ. WATTS: 250w
VOLTAGE/FREQUENCY: AC:220-240V, 50Hz
LUMINOUS FLUX: 4000lm
COMMERCIAL TYPE: ED120

LED TYPE: Filament
CRI: >80
PF: >0.6
BASE: E27

BEAM ANGLE: 310°
BODY TYPE: Glass
DIMENSION: 120x300mm
BOX QTY: 20

LED AMBER FILAMENT A60

V-TAC's decorative Amber Filament Lamp range is devised with the latest technology to provide the warm look and feel of conventional filament bulbs.

- 20,000 hrs Lifespan
- 300° Beam Angle
- AC:220-240V,50Hz
- CRI: >80

3 YEAR
WARRANTY*



A60 | E27



A60 | B22

MODEL	WATTS	EQ.WATTS	LUMENS	BASE	SHAPE	BOX QTY.
VT-266	6w	55w	725	E27	A60	50 pcs

SKU:286 | 2200K WARM WHITE

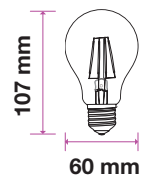
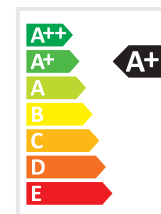

MODEL	WATTS	EQ.WATTS	LUMENS	BASE	SHAPE	BOX QTY.
VT-228	4w	35w	350	B22	A60	96 pcs

SKU:107 | 2200K WARM WHITE

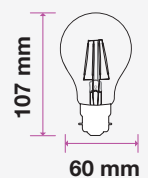
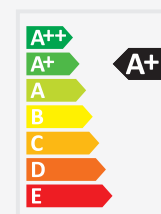

LED AMBER FILAMENT

G95 | G125 | ST64

V-TAC's decorative Amber Filament Lamp range is devised with the latest technology to provide the warm look and feel of conventional filament bulbs.

- **20,000 hrs Lifespan**
- **300° Beam Angle**
- **AC:220-240V,50Hz**
- **CRI: >80**

3 YEAR
WARRANTY*



G125



ST64

MODEL	WATTS	EQ.WATTS	LUMENS	BASE	SHAPE	BOX QTY.
VT-297	6w	55w	725	E27	G125	20 pcs

SKU: 291 | 2200K WARM WHITE

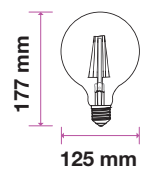
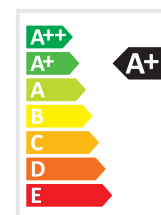

MODEL	WATTS	EQ.WATTS	LUMENS	BASE	SHAPE	BOX QTY.
VT-276	6w	55w	725	E27	ST64	50 pcs

SKU: 290 | 2200K WARM WHITE

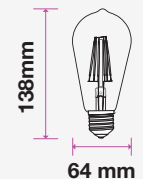
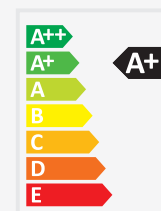

LED CLEAR FILAMENT

A60

V-TAC's decorative and efficient LED filament range also comes in an elegant, clear glass body for a classic vintage design in A60, candle, and globe shapes that can replace 35 to 60-watt traditional filament bulbs.

- **20,000 hrs Lifespan**
- **300° Beam Angle**
- **AC:220-240V,50Hz**
- **CRI: >80**

3 TO 5
 YEAR
 WARRANTY*



A60 | E27



A60 | B22

MODEL	WATTS	EQ.WATTS	LUMENS	BASE	SHAPE	BOX QTY.
VT-256	6w	60w	806	E27	A60	50 pcs

SKU: 287 | 2700K WARM WHITE

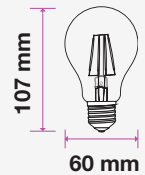
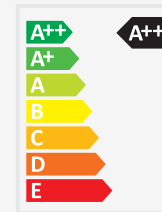

MODEL	WATTS	EQ.WATTS	LUMENS	BASE	SHAPE	BOX QTY.
VT-208	4w	40w	400	B22	A60	96 pcs

SKU: 106 | 3000K WARM WHITE

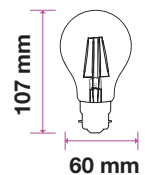
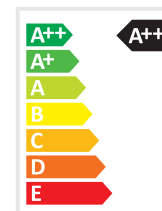

LED CLEAR FILAMENT

Candle



Candle | B22



Candle | E14



Twist Candle



Flame Candle

MODEL	WATTS	EQ.WATTS	LUMENS	BASE	SHAPE	BOX QTY.
VT-222	4w	40w	400	B22	Candle	192 pcs

SKU: 105 | 3000K WARM WHITE

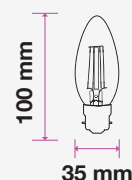
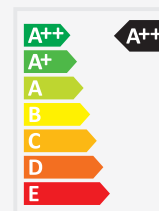

MODEL	WATTS	EQ.WATTS	LUMENS	BASE	SHAPE	BOX QTY.
VT-254	4w	35w	400	E14	Candle	100 pcs

SKU: 272 | 2700K WARM WHITE

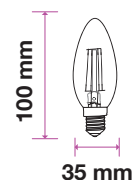
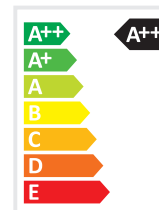

MODEL	WATTS	EQ.WATTS	LUMENS	BASE	SHAPE	BOX QTY.
VT-254D	4w	30w	350	E14	Candle	100 pcs

SKU: 278 | 2700K WARM WHITE

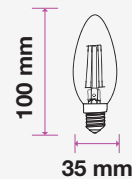
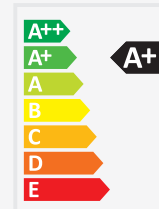

MODEL	WATTS	EQ.WATTS	LUMENS	BASE	SHAPE	BOX QTY.
VT-274	4w	35w	400	E14	Candle	100 pcs

SKU: 279 | 2700K WARM WHITE

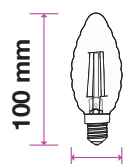
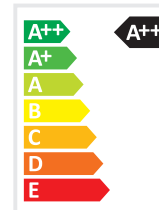

MODEL	WATTS	EQ.WATTS	LUMENS	BASE	SHAPE	BOX QTY.
VT-264	4w	35w	400	E14	Candle	100 pcs

SKU: 275 | 2700K WARM WHITE

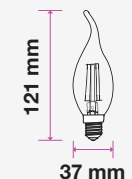
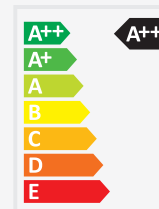

LED CLEAR FILAMENT
 Candle | G45 | G95 | G125

3 TO 5 YEAR
 WARRANTY*



Candle



G45



G95



G125

MODEL	WATTS	EQ.WATTS	LUMENS	BASE	BOX QTY.
VT-284D	4w	30w	350	B15	100 pcs

SKU: 862 | 3000K WARM WHITE

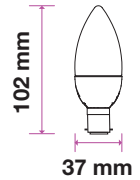
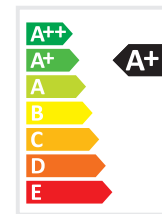

MODEL	WATTS	EQ.WATTS	LUMENS	BASE	SHAPE	BOX QTY.
VT-244	4w	35w	400	E27	G45	100 pcs

SKU: 280 | 2700K WARM WHITE
 SKU: 944 | 4000K DAY WHITE

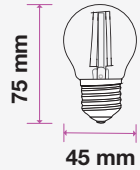
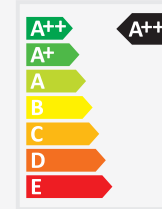

MODEL	WATTS	EQ.WATTS	LUMENS	BASE	SHAPE	BOX QTY.
VT-286	6w	60w	806	E27	G95	20 pcs

SKU: 294 | 2700K WARM WHITE

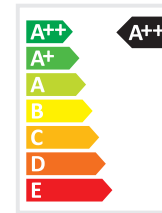

MODEL	WATTS	EQ.WATTS	LUMENS	BASE	SHAPE	BOX QTY.
VT-287	6w	60w	806	E27	G125	20 pcs

SKU: 292 | 2700K WARM WHITE

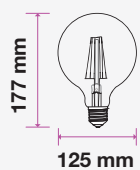
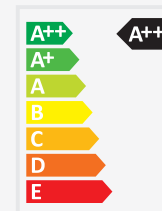

High Lumen Bulbs

Adequate light at an optimal cost – equipped with **Samsung LED chip**, V-TAC's complete range of high-lumen LED lamps includes a vast array of general-purpose lighting solutions with the efficiency of modern LED lighting technology at 120 lumens per watt. Better design, quality, and performance; truly an innovative take on traditional lamps.

120 ±
LUMENS/ WATT
SUPER EFFICIENT

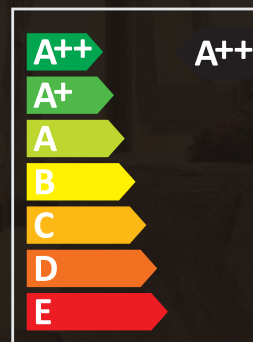

HIGH LUMEN BULBS

C37 | G45 | P45

Available in warm to bright color temperatures, this high-lumen range includes candelabra-style C37 lamps, 45mm diameter spheroid/ping pong G45 bulbs, and 45mm pear-shaped bulbs for a complete selection of lamps to meet a desired combination for mood and task lighting in residential and commercial spaces.

- A++ energy rating
- 120 lm/w
- 30,000-hr lifespan
- 200° Beam Angle
- AC:220-240V,50Hz
- CRI: >80

5 YEAR WARRANTY*



C37



G45



P45

MODEL	WATTS	EQ.WATTS	LUMENS	BASE	SHAPE	BOX QTY.
VT-255	4.5w	40w	470	E14	Candle	200 pcs

SKU: 258 | 3000K WARM WHITE
 SKU: 259 | 4000K DAY WHITE
 SKU: 260 | 6400K WHITE

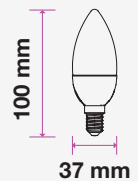
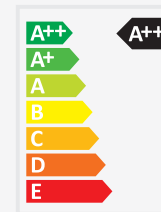

MODEL	WATTS	EQ.WATTS	LUMENS	BASE	SHAPE	BOX QTY.
VT-245	4.5w	40w	470	E27	G45	200 pcs

SKU: 261 | 3000K WARM WHITE
 SKU: 262 | 4000K DAY WHITE
 SKU: 263 | 6400K WHITE

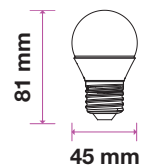
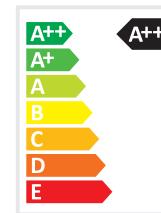

MODEL	WATTS	EQ.WATTS	LUMENS	BASE	SHAPE	BOX QTY.
VT-225	4.5w	40w	470	E14	P45	200 pcs

SKU: 264 | 3000K WARM WHITE
 SKU: 265 | 4000K DAY WHITE
 SKU: 266 | 6400K WHITE

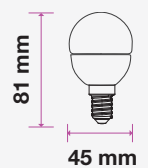
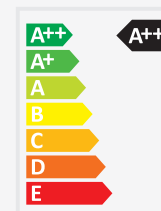

HIGH LUMEN BULBS

A60 | A65 | G120

5 YEAR
WARRANTY*



A60



A65



G120

MODEL	WATTS	EQ.WATTS	LUMENS	BASE	SHAPE	BOX QTY.
VT-265	6.5w	60w	806	E27	A60	100 pcs

SKU: 255 | 3000K WARM WHITE
SKU: 256 | 4000K DAY WHITE
SKU: 257 | 6400K WHITE

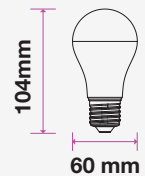
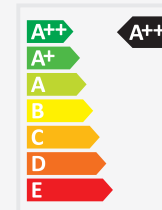

MODEL	WATTS	EQ.WATTS	LUMENS	BASE	SHAPE	BOX QTY.
VT-285	8.5w	75w	1055	E27	A60	100 pcs

SKU: 252 | 3000K WARM WHITE
SKU: 253 | 4000K DAY WHITE
SKU: 254 | 6400K WHITE

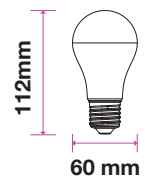
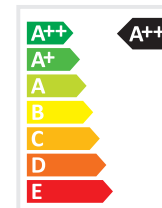

MODEL	WATTS	EQ.WATTS	LUMENS	BASE	SHAPE	BOX QTY.
VT-295	12w	100w	1521	E27	A65	100 pcs

SKU: 249 | 3000K WARM WHITE
SKU: 250 | 4000K DAY WHITE
SKU: 251 | 6400K WHITE

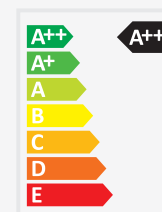

MODEL	WATTS	EQ.WATTS	LUMENS	BASE	SHAPE	BOX QTY.
VT-242	22w	160	2650	E27	G120	20 pcs

SKU: 20021 | 3000K WARM WHITE
SKU: 20022 | 4000K DAY WHITE
SKU: 20023 | 6400K WHITE

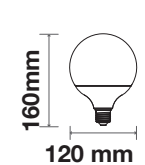
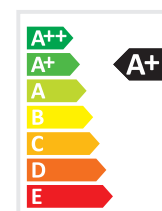



LED Plastic Bulbs

The definition of sustainability: sharing the incandescent bulb's design and built for higher energy, V-TAC's comprehensive thermoplastic bulb series can be proposed for a wide variety of high-end projects.

- Ideal retrofit for E27, E14 and B22 holders
- Longer lifespan than conventional bulbs
- Instant startup
- Options! Available in three color temperatures
- Set the right tone: dimmable options available
- Customized exterior for a stronger body

LED PLASTIC BULBS

ST26 | T37

A decorative and efficient range of Candle, G45, P45, lamps for intricate light fittings in wall lamps, chandeliers and table lamps. This new generation of LED plastic bulbs includes our 9w to 18w A58, A65, and A80 lamps which are ideal for general purpose lighting at residential, commercial, and industrial areas.

- **ST26, T37, C37, and G45 shapes available**
- **On/Off cycles: >20000**
- **Standard color temperatures**
- **30,000-hr lifespan**
- **200° Beam Angle**
- **AC:220-240V,50Hz**
- **CRI: >80**

5 YEAR WARRANTY*



ST26



T37



T37

MODEL	WATTS	EQ.WATTS	LUMENS	BASE	SHAPE	BOX QTY.
VT-202	2w	20w	180	E14	ST26	400 pcs
SKU: 234 3000K WARM WHITE SKU: 235 4000K DAY WHITE SKU: 236 6400K WHITE						

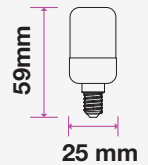
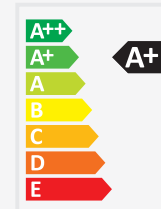

MODEL	WATTS	EQ.WATTS	LUMENS	BASE	SHAPE	BOX QTY.
VT-248	8w	50w	660	E14	T37	200 pcs
SKU: 267 3000K WARM WHITE SKU: 268 4000K DAY WHITE SKU: 269 6400K WHITE						

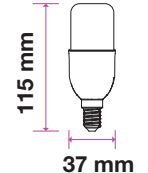
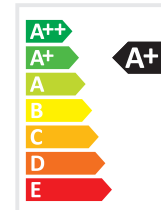

MODEL	WATTS	EQ.WATTS	LUMENS	BASE	SHAPE	BOX QTY.
VT-237	8w	50w	660	E27	T37	200 pcs
SKU: 144 3000K WARM WHITE SKU: 145 4000K DAY WHITE SKU: 146 6400K WHITE						

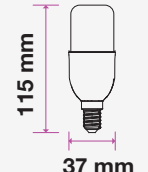
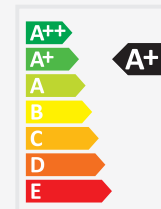

LED PLASTIC BULBS
Candle C37

5 YEAR
WARRANTY*



Candle | E14



Candle | E27



Flame Candle



Candle | E14

MODEL	WATTS	EQ.WATTS	LUMENS	BASE	SHAPE	BOX QTY.
VT-226	5.5w	40w	470	E14	Candle	200 pcs
SKU: 171 3000K WARM WHITE						
SKU: 172 4000K DAY WHITE						
SKU: 173 6400K WHITE						

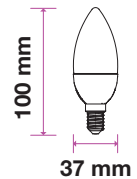

MODEL	WATTS	EQ.WATTS	LUMENS	BASE	SHAPE	BOX QTY.
VT-293D	5.5w	40w	470	E14	Candle	200 pcs
SKU: 20045 3000K WARM WHITE						

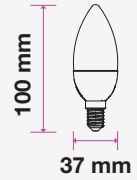
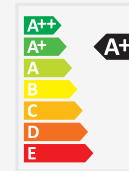

MODEL	WATTS	EQ.WATTS	LUMENS	BASE	SHAPE	BOX QTY.
VT-294D	5.5w	40w	470	E14	Candle	200 pcs
SKU: 859 3000K WARM WHITE						

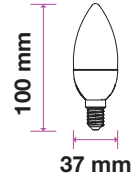
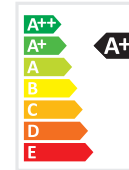

MODEL	WATTS	EQ.WATTS	LUMENS	BASE	SHAPE	BOX QTY.
VT-289	5.5w	40w	470	E27	Candle	200 pcs
SKU: 858 3000K WARM WHITE						

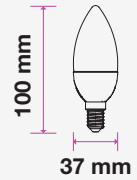
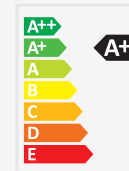

MODEL	WATTS	EQ.WATTS	LUMENS	BASE	SHAPE	BOX QTY.
VT-258	5.5w	40w	470	E14	Candle	200 pcs
SKU: 117 3000K WARM WHITE						
SKU: 118 4000K DAY WHITE						
SKU: 119 6400K WHITE						

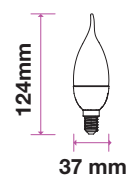

MODEL	WATTS	EQ.WATTS	LUMENS	BASE	SHAPE	BOX QTY.
VT-268	7w		600	E14	Candle	200 pcs
SKU: 111 3000K WARM WHITE						
SKU: 112 4000K DAY WHITE						
SKU: 113 6400K WHITE						

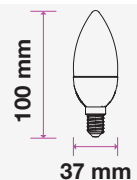

LED PLASTIC BULBS

G45 | P45

5 YEAR WARRANTY*



G45



P45

MODEL	WATTS	EQ.WATTS	LUMENS	BASE	SHAPE	BOX QTY.
VT-246	5.5w	40w	470	E27	G45	200 pcs
SKU: 174	3000K WARM WHITE					
SKU: 175	4000K DAY WHITE					
SKU: 176	6400K WHITE					

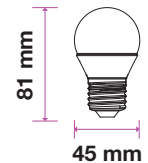

MODEL	WATTS	EQ.WATTS	LUMENS	BASE	SHAPE	BOX QTY.
VT-283	5.5w	40w	470	E27	G45	200 pcs
SKU: 857	3000K WARM WHITE					

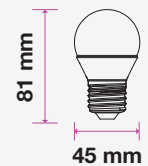

MODEL	WATTS	EQ.WATTS	LUMENS	BASE	SHAPE	BOX QTY.
VT-290	7w	45w	600	E27	G45	200 pcs
SKU: 866	3000K WARM WHITE					
SKU: 867	4000K DAY WHITE					
SKU: 868	6400K WHITE					

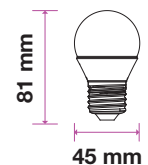

MODEL	WATTS	EQ.WATTS	LUMENS	BASE	SHAPE	BOX QTY.
VT-236	5.5w	40w	470	E14	P45	200 pcs
SKU: 168	3000K WARM WHITE					
SKU: 169	4000K DAY WHITE					
SKU: 170	6400K WHITE					

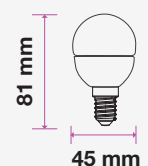

MODEL	WATTS	EQ.WATTS	LUMENS	BASE	SHAPE	BOX QTY.
VT-282	5.5w	40w	470	E14	P45	200 pcs
SKU: 856	3000K WARM WHITE					

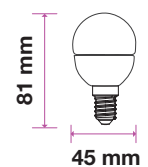

MODEL	WATTS	EQ.WATTS	LUMENS	BASE	SHAPE	BOX QTY.
VT-270	7w	45w	600	E14	P45	200 pcs
SKU: 863	3000K WARM WHITE					
SKU: 864	4000K DAY WHITE					
SKU: 865	6400K WHITE					

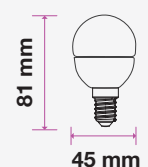

LED PLASTIC BULBS

A58 | A60

5 YEAR
WARRANTY*



A58 | E14



A58 | E27



A60 | E27

MODEL	WATTS	EQ.WATTS	LUMENS	BASE	SHAPE	BOX QTY.
VT-269	9w	60w	806	E14	A58	100 pcs

SKU: 114 | 3000K WARM WHITE
SKU: 115 4000K DAY WHITE
SKU: 116 | 6400K WHITE

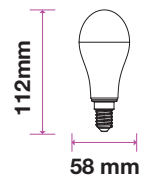
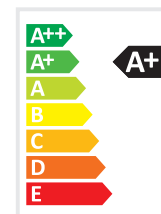

MODEL	WATTS	EQ.WATTS	LUMENS	BASE	SHAPE	BOX QTY.
VT-210	9w	60w	806	E27	A58	100 pcs

SKU: 228 | 3000K WARM WHITE
SKU: 229 | 4000K DAY WHITE
SKU: 230 | 6400K WHITE

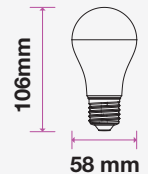
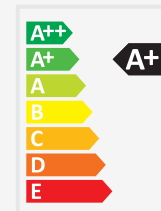

MODEL	WATTS	EQ.WATTS	LUMENS	BASE	SHAPE	BOX QTY.
VT-212	11w	75w	1055	E27	A60	100 pcs

SKU: 231 | 3000K WARM WHITE
SKU: 232 | 4000K DAY WHITE
SKU: 233 | 6400K WHITE

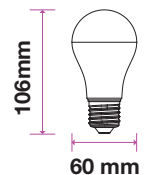
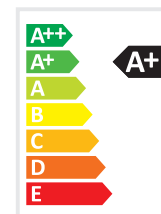

MODEL	WATTS	EQ.WATTS	LUMENS	BASE	SHAPE	BOX QTY.
VT-262D	12w	75w	1055	E27	A60	100 pcs

SKU: 20044 | 3000K WARM WHITE

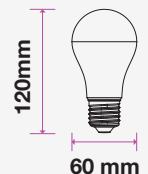
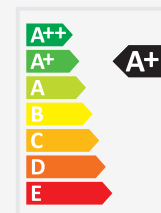

LED PLASTIC BULBS

A65 | A80

5 YEAR
WARRANTY*



A60 | E27



A80 | E27

MODEL	WATTS	EQ.WATTS	LUMENS	BASE	SHAPE	BOX QTY.
VT-215	15w	85w	1250	E27	A65	100 pcs
SKU: 159 3000K WARM WHITE SKU: 160 4000K DAY WHITE SKU: 161 6400K WHITE						

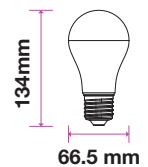
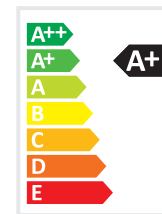

MODEL	WATTS	EQ.WATTS	LUMENS	BASE	SHAPE	BOX QTY.
VT-217	17w	100w	1521	E27	A65	100 pcs
SKU: 162 3000K WARM WHITE SKU: 163 4000K DAY WHITE SKU: 164 6400K WHITE						

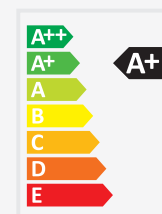

MODEL	WATTS	EQ.WATTS	LUMENS	BASE	SHAPE	BOX QTY.
VT-298	18w	125w	2000	E27	A80	100 pcs
SKU: 126 3000K WARM WHITE SKU: 127 4000K DAY WHITE SKU: 128 6400K WHITE						

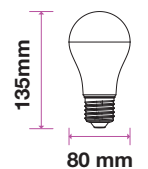
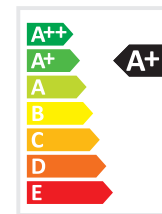

MODEL	WATTS	EQ.WATTS	LUMENS	BASE	SHAPE	BOX QTY.
VT-233	20w	150w	2452	E27	A80	50 pcs
SKU: 237 3000K WARM WHITE SKU: 238 4000K DAY WHITE SKU: 239 6400K WHITE						

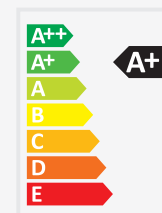

LED PLASTIC BULBS

Candle | G45



Candle | B15



Candle | B22



G45

MODEL	WATTS	EQ.WATTS	LUMENS	BASE	SHAPE	BOX QTY.
VT-299	5.5w	40w	470	B15	Candle	200 pcs

SKU: 860 | 3000K WARM WHITE

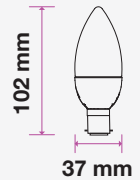
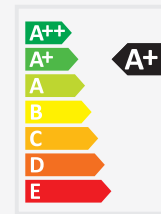

MODEL	WATTS	EQ.WATTS	LUMENS	BASE	SHAPE	BOX QTY.
VT-299D	5.5w	40w	470	B15	Candle	200 pcs

SKU: 861 | 3000K WARM WHITE

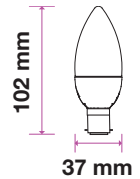
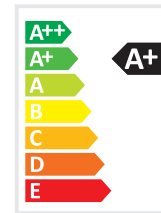

MODEL	WATTS	EQ.WATTS	LUMENS	BASE	SHAPE	BOX QTY.
VT-223	5.5w	40w	470	B22	Candle	192 pcs

SKU: 103 | 3000K WARM WHITE

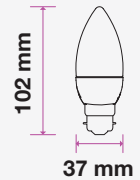
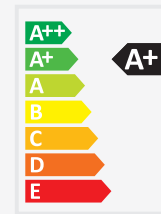

MODEL	WATTS	EQ.WATTS	LUMENS	BASE	SHAPE	BOX QTY.
VT-221	5.5w	40w	470	B22	G45	192 pcs

SKU: 104 | 3000K WARM WHITE

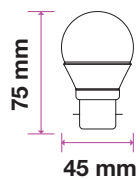
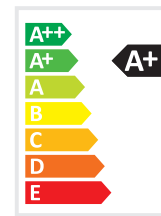

LED PLASTIC BULBS
 A58



A58

MODEL	WATTS	EQ.WATTS	LUMENS	BASE	SHAPE	BOX QTY.
VT-229	9w	60w	806	B22	A58	96 pcs
SKU: 101 3000K WARM WHITE SKU: 850 4000K DAY WHITE SKU: 851 6400K WHITE						

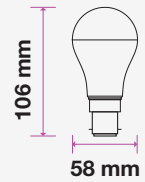
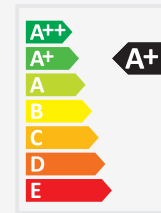

MODEL	WATTS	EQ.WATTS	LUMENS	BASE	SHAPE	BOX QTY.
VT-259D	9w	60	806	B22	A58	100 pcs
SKU: 852 3000K WARM WHITE						

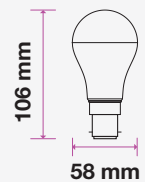
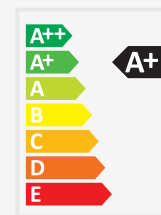

LED PLASTIC BULBS

A60 | A65



5 YEAR
WARRANTY*



A60



A65

MODEL	WATTS	EQ.WATTS	LUMENS	BASE	SHAPE	BOX QTY.
VT-213	11w	75w	1055	B22	A60	100 pcs

SKU:110 | 4000K DAY WHITE

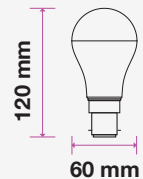
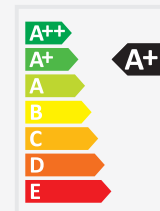

MODEL	WATTS	EQ.WATTS	LUMENS	BASE	SHAPE	BOX QTY.
VT-231	11w	75w	1055	B22	A60	96 pcs

SKU: 102 | 3000K WARM WHITE

SKU: 853 | 6400K WHITE



ALSO AVAILABLE

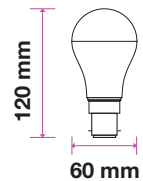
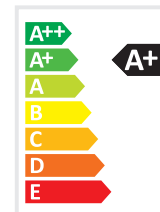

MODEL	WATTS	EQ.WATTS	LUMENS	BASE	SHAPE	BOX QTY.
VT-281	15w	85w	1250	B22	A65	100 pcs

SKU: 854 | 3000K WARM WHITE

SKU:943 | 4000K DAY WHITE

SKU: 855 | 6400K WHITE



ALSO AVAILABLE

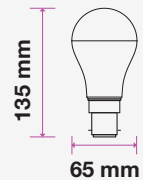
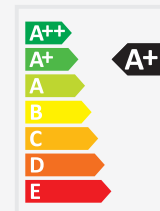

LED REFLECTOR BULB

We offer an energy-efficient reflectors range of various widths (39mm, 50mm, 63mm, 80mm) for diffused lighting that can serve as track or spotlight in residential, hospitality, or commercial spaces.

• Available in E14 and E27

- 30,000-hr lifespan
- 120° Beam Angle
- AC:220-240V,50Hz
- CRI: >80

5 YEAR WARRANTY*



R39



R50



R63



R80

MODEL	WATTS	EQ.WATTS	LUMENS	BASE	SHAPE	BOX QTY.
VT-239	3w	25w	250	E14	R39	200 pcs
SKU: 210 3000K WARM WHITE SKU: 211 4000K DAY WHITE SKU: 212 6400K WHITE						

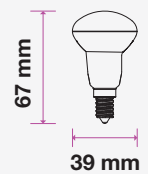
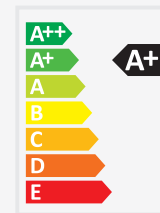

MODEL	WATTS	EQ.WATTS	LUMENS	BASE	SHAPE	BOX QTY.
VT-250	6w	40w	470	E14	R50	200 pcs
SKU: 138 3000K WARM WHITE SKU: 139 4000K DAY WHITE SKU: 140 6400K WHITE						

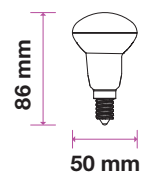
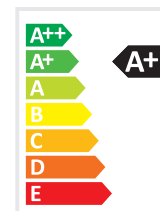

MODEL	WATTS	EQ.WATTS	LUMENS	BASE	SHAPE	BOX QTY.
VT-263	8w	60w	570	E27	R63	200 pcs
SKU: 141 3000K WARM WHITE SKU: 142 4000K DAY WHITE SKU: 143 6400K WHITE						

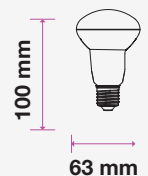
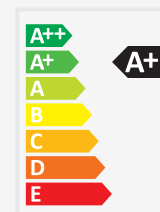

MODEL	WATTS	EQ.WATTS	LUMENS	BASE	SHAPE	BOX QTY.
VT-280	10w	75w	800	E27	R80	200 pcs
SKU: 135 3000K WARM WHITE SKU: 136 4000K DAY WHITE SKU: 137 6400K WHITE						

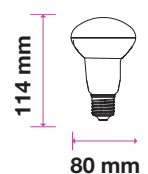
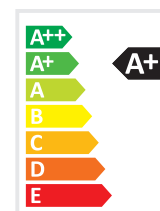

LED PAR BULB

Provide precisely control LED beams of light to any space with V-TAC's improved range of LED PAR bulbs with 40° beam angle. With a significantly longer lifespan and up to 80% lower energy-consumption, our LED PAR series is your cost-efficient replacement for Halogen PAR lamps. Our PAR series offers advanced thermal management features and uses LEDs provided by Samsung.

- Uses IP-protected Samsung LED chip
- 20,000 hrs Lifespan
- 300° Beam Angle
- AC:220-240V,50Hz
- CRI: >80

5 YEAR WARRANTY*



PAR20



PAR30



PAR38

MODEL	WATTS	EQ.WATTS	LUMENS	BASE	SHAPE	BOX QTY.
VT-220	7w	65w	495	E27	PAR20	100 pcs

SKU: 147 | 3000K WARM WHITE
 SKU: 148 | 4000K DAY WHITE
 SKU: 149 | 6400K WHITE

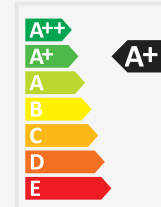

MODEL	WATTS	EQ.WATTS	LUMENS	BASE	SHAPE	BOX QTY.
VT-230	11w	95w	825	E27	PAR30	30 pcs

SKU: 153 | 3000K WARM WHITE
 SKU: 154 | 4000K DAY WHITE
 SKU: 155 | 6400K WHITE

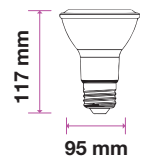

MODEL	WATTS	EQ.WATTS	LUMENS	BASE	SHAPE	BOX QTY.
VT-238	14w	120w	1100	E27	PAR38	30 pcs

SKU: 150 | 3000K WARM WHITE
 SKU: 151 | 4000K DAY WHITE
 SKU: 152 | 6400K WHITE

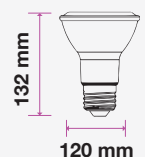
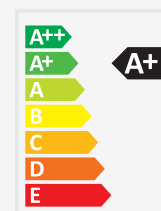

LED BULBS

UFO Bulb

V-TAC's Big Bulb range are ready to meet lighting demands for big spaces that require broader lighting with its range of unique designs, all with significantly greater luminous flux. This range has lamps with diameter ranging from 75mm up to 250mm. Despite the great size, these LED big bulbs are equipped with modern thermal management so it will not heat up and has LEDs provided by Samsung for maximum efficiency.

- **30,000 hrs Lifespan**
- **AC:220-240V,50Hz**
- **CRI: >80**

5 YEAR WARRANTY*



F150



F200



F250

MODEL	WATTS	EQ.WATTS	LUMENS	BASE	SHAPE	BOX QTY.
VT-216	15w	80w	1200	E27	F150	20 pcs
SKU: 213 3000K WARM WHITE SKU: 214 4000K DAY WHITE SKU: 215 6400K WHITE						

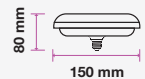
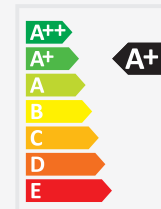

MODEL	WATTS	EQ.WATTS	LUMENS	BASE	SHAPE	BOX QTY.
VT-224	24w	120w	1900	E27	F200	20 pcs
SKU: 216 3000K WARM WHITE SKU: 217 4000K DAY WHITE SKU: 218 6400K WHITE						

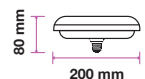
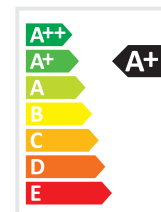

MODEL	WATTS	EQ.WATTS	LUMENS	BASE	SHAPE	BOX QTY.
VT-235	36w	170w	2900	E27	F250	20 pcs
SKU: 219 3000K WARM WHITE SKU: 220 4000K DAY WHITE SKU: 221 6400K WHITE						

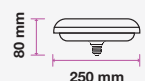
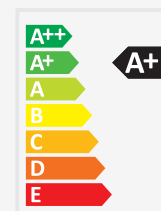

LED BULBS
 PAR Bulb | G120

5 YEAR
 WARRANTY*



GX53



G120

MODEL	WATTS	EQ.WATTS	LUMENS	BASE	BOX QTY.
VT-207	7w	45w	550	GX53	200 pcs
SKU: 222 3000K WARM WHITE					
SKU: 223 4000K DAY WHITE					
SKU: 224 6400K WHITE					

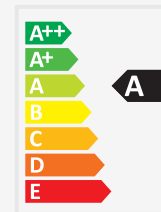

MODEL	WATTS	EQ.WATTS	LUMENS	BASE	SHAPE	BOX QTY.
VT-218	17w	100w	1521	E27	G120	20 pcs
SKU: 226 4000K DAY WHITE						

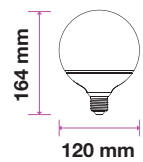

MODEL	WATTS	EQ.WATTS	LUMENS	BASE	SHAPE	BOX QTY.
VT-288	18w		2000	E27	G120	20 pcs
SKU: 123 3000K WARM WHITE						
SKU: 124 4000K DAY WHITE						
SKU: 125 6400K WHITE						

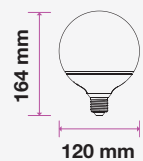
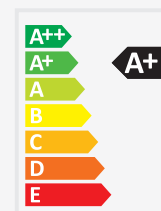

LED BULBS

LED Big Bulb | Lowbay

5 YEAR
WARRANTY*



E27



E40



E40

MODEL	WATTS	LUMENS	BASE	BOX QTY.
VT-240	36w	3960	E27	20 pcs

- SKU: 283 | 3000K WARM WHITE
- SKU: 284 | 4000K DAY WHITE
- SKU: 285 | 6400K WHITE

2 YEAR
WARRANTY*

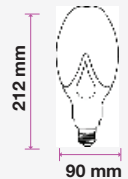

MODEL	WATTS	LUMENS	BASE	BOX QTY.
VT-260	60w	5400	E40	20 pcs

- SKU: 186 | 3000K WARM WHITE
- SKU: 187 | 4000K DAY WHITE
- SKU: 188 | 6400K WHITE

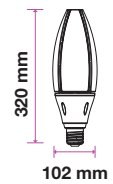

MODEL	WATTS	LUMENS	BASE	BOX QTY.
VT-85	85w	6800	E40	4 pcs

- SKU: 521 | 6400K WHITE



LED BIG BULBS

Acrylic Bulbs

5 YEAR WARRANTY*

V-TAC's Acrylic Bulb range with its unique designs, all with significantly greater luminous flux. Despite the great size, these LED big bulbs are equipped with modern thermal management so it will not heat up and has LEDs provided by Samsung for maximum efficiency.

- **30,000 hrs Lifespan**
- **AC:220-240V,50Hz**
- **CRI: >80**
- **PF >0.5**
- **120° Beam Angle**
- **Acrylic+Aluminum+Plastic Material**



11w



18w

MODEL	WATTS	EQ.WATTS	LUMENS	BASE	BOX QTY.
VT-2311	11w	70w	900	E27	18 pcs

- SKU: 2781 | 3000K WARM WHITE
- SKU: 2782 | 4000K DAY WHITE
- SKU: 2783 | 6400K WHITE

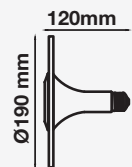
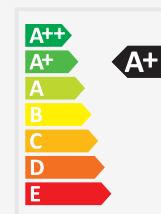

MODEL	WATTS	EQ.WATTS	LUMENS	BASE	BOX QTY.
VT-2318	18w	90w	1200	E27	18 pcs

- SKU: 2784 | 3000K WARM WHITE
- SKU: 2785 | 4000K DAY WHITE
- SKU: 2786 | 6400K WHITE

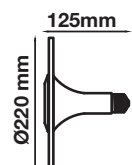
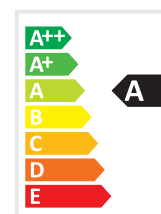

LED BULBS

LED Emergency Bulb

Multi-Functional LED Bulb — Our Emergency Light Bulb is portable, and can be used as camping light, flashlight, hook light, warehouse light and use as normal bulb aswell.

- 30,000 hrs Lifespan
- AC:220-240V,50Hz
- CRI: >80
- 200° Beam Angle

Emergency Specs

- 280lm Lumens
- Power:3W
- 3 Hour Working Time
- 6 Hour Charging Time:
- Lithium Battery DC:3.7V, 1800mAh



**EMERGENCY
 BATTERY**

2 YEAR
WARRANTY*



MODEL	WATTS	LUMENS	BASE	BOX QTY.
VT-2309	9w	806	E27	50 pcs

- SKU: 2371 | 3000K WARM WHITE
- SKU: 2372 | 4000K DAY WHITE
- SKU: 2373 | 6400K WHITE

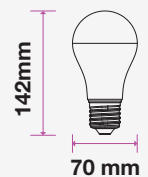
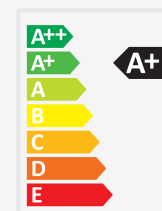

Certificates

DIALux Partner

Certificate

This is to certify that

V-TAC Europe Ltd.

is an official DIALux Partner.

2017

DIALux improves the lighting design process by making it accessible and easy to apply for everyone.

Lüdenscheid, 2017-01-02



Dieter Polle
General Manager



Friedrich W. Bremecker
International Sales

DIALux is a registered trademark of DIAL GmbH.

DIALux Partner

CERTIFICATE
No. ZTA 10 10 3304 000

Holder of Certificate: **V-TAC Europe Ltd.**
Rupertstrasse 50 1
52624
Bilzlar

Certification Mark: 

Product: **LED Lampe
LED Lamp**

Tested according to: EN 60528:2012
EN 60341:2009
EN 60529:2012
IEC 60529:2014 IEC 60529

The product meets the safety and health requirements of the German Product Safety Act under § 2(2) of the Product Safety Act. The certificate holder shall ensure that the product is not put on the market or used in a way that is not permitted by the certificate holder. The certificate holder shall ensure that the product is not put on the market or used in a way that is not permitted by the certificate holder. The certificate holder shall ensure that the product is not put on the market or used in a way that is not permitted by the certificate holder.

Test report no.: 0101000000-00
Valid until: 2019-11-02

Date: 2016-11-09
Page 1 of 2

TUV SUD Product Service GmbH · Südstraße 91 · 80539 München · Germany

TUV

Certificate of Conformity

Certification No.: G0113080720E

Applicant: V-TAC EXPORTS LIMITED

Address: ROOM NO. 301, KAM ON BUILDING 176A QUEENS ROAD
CENTRAL, CENTRAL, HONGKONG

Manufacturer: V-TAC EXPORTS LIMITED

Address: ROOM NO. 301, KAM ON BUILDING 176A QUEENS ROAD
CENTRAL, CENTRAL, HONGKONG

Certification Marking: CE-EMC

Product Description: LED DOWN LIGHT

Model: VT-2016, VT-2015, VT-2030

Trademark: **V-TAC**

An independent evaluation on the above-mentioned product(s) has been conducted pursuant to the requirements of the European Parliament and of the Council of 18 June 2002 on the restriction of the use of certain hazardous substances in electrical and electronic equipment, and concluded that the equipment under evaluation met the regulatory requirements of this directive.

RoHS

Authorized Signer: James Zhao/Manager
June 3, 2015

RoHS

Certificate of Conformity

Certification No.: G0113080720E

Applicant: V-TAC EXPORTS LIMITED

Address: ROOM NO. 301, KAM ON BUILDING 176A QUEENS ROAD
CENTRAL, CENTRAL, HONGKONG

Manufacturer: V-TAC EXPORTS LIMITED

Address: ROOM NO. 301, KAM ON BUILDING 176A QUEENS ROAD
CENTRAL, CENTRAL, HONGKONG

Certification Marking: CE-EMC

Product Description: LED DOWN LIGHT

Model: VT-2016, VT-2015, VT-2030

Trademark: **V-TAC**

Sufficient samples of the product have been tested and found to be in conformity with:

Test Standards	EN 50175:2009 + A1:2007 + A2:2009
	EN 50470:2009
	EN 61000-3-2:2006+A1:2009+A2:2009
	EN 61000-3-3:2008

When tested as specified, the submitted sample complies with EMC Directive 2014/53/EU. This certificate is based on a single evaluation of one sample of above-mentioned products. It does not imply an assessment of the whole production and does not permit the use of the test laboratory logo.

CE

Authorized Signer: James Zhao/Manager
June 3, 2015

CE / LVD



Certified and Tested



CE/EMC

INTRODUCING THE NEW SERIES



Our bestselling LED Lights — now upgraded with a superior efficiency of **160 lm/W** through the latest in LED technology.

*Super***BRIGHT**
160
LUMENS/W

5 YEAR
WARRANTY



Head Offices

Sofia | London

Europe Office
41, bul. Rozhen
1271 Sofia, Bulgaria

UK Office

V-TAC House,
Kelpatrick Road,
Slough, Berkshire,
SL1 6BW, UK.
www.v-tac.co.uk

Middle East Office

Unit# 407/8/9 Jumeirah
Bay Towers,
Plot# X3, JLT,
P.O. Box 45244, Dubai.
www.vtacexports.com

SMART SPEAKERS **SMART TABLE LAMPS**

PENDANTS

LED STRIP LIGHTS

TOWER FANS LED CEILING FAN

POWER BANK

LED SPOT LIGHTS **CAMERAS**

TABLE LIGHTS **LED SOLAR LIGHTS** FIRE RATED LIGHTS LED LINEAR LIGHTS

X-ON Electronics

Largest Supplier of Electrical and Electronic Components

Click to view similar products for [Mounting Fixings](#) category:

Click to view products by [V-TAC](#) manufacturer:

Other Similar products are found below :

[5912235-1 REV - 007541](#) [627](#) [M3783-7001](#) [75-69224-5S](#) [7717-8DAP](#) [85048GBESR](#) [FPK-02-R10](#) [PMS27488-001-01](#) [1-18023-0](#) [H-118-2](#)
[DB1](#) [1302030464](#) [1302010957](#) [1302263564](#) [1302340393](#) [1404-0016-78](#) [14540](#) [1561-60](#) [1566](#) [1566](#) [BR16A](#) [NT20SATT01](#) [22594-8](#) [KBB-](#)
[141](#) [89078GBEPR](#) [915060](#) [SF4011-60101](#) [97-CS-50](#) [1671](#) [1855-54](#) [T-2085-SP](#) [20800240002](#) [21899-4](#) [2193](#) [2518](#) [25745-1](#) [H-118-1](#)
[354467](#) [37184](#) [4658](#) [4665](#) [4731](#) [BRACKET-RA-30](#) [5500083](#) [HS5659MB98SN](#) [561-T001](#) [4222522019-542](#) [LF9Z-1SB22](#) [4601463120-542](#)