

三端1.5A正电源稳压电路

概述

WD7805G系列是三端正电源稳压电路，它的封装形式为TO-220。它有一系列固定的电压输出，应用非常的广泛。每种类型由于内部电流的限制，以及过热保护和安全工作区的保护，使它基本上不会损坏。如果能够提供足够的散热片，它们就能够提供大于1.5A的输出电流。虽然是按照固定电压值来设计的，但是当接入适当的外部器件后，就能获得各种不同的电压和电流。

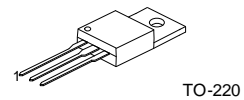

特点

- * 最大输出电流为1.5A
- * 输出电压为5V;6V;8V;9V;10V;12V;15V
- * 热过载保护
- * 短路保护
- * 输出晶体管安全工作区保护

1:输入; 2:接地; 3:输出

内部框图

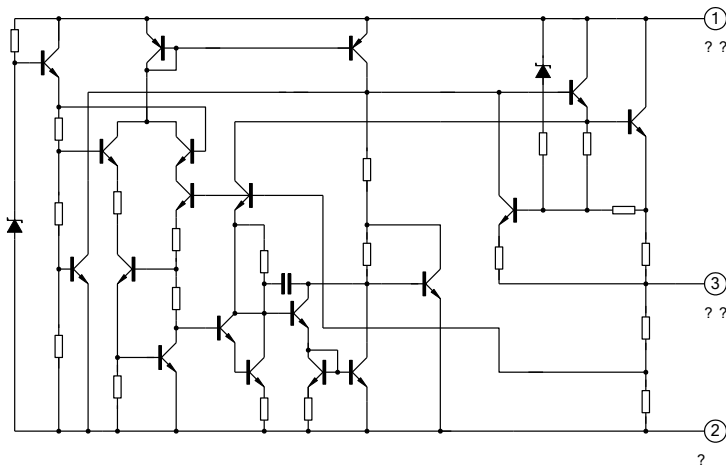

极限参数(Ta=25°C)

参数	符号	数值	单位
输入电压 (Vo=5V to 15V)	Vi	35	V
结到空气热阻	R θ JA	TO-220F	60
		TO-220	50
		TO-252	62.5
结到壳热阻	R θ JC	TO-220F	5
		TO-220	5
		TO-252	3
工作温度	Topr	-20~ +125	°C
贮存温度	Tstg	-65 ~ +150	°C

WD7805G 电参数

(除特别说明, 0<Tj<125°C, Io=500mA, Vi=10V, Ci=0.33 μ F, Co=0.1 μ F)

参数	符号	测试条件	最小值	典型值	最大值	单位
输出电压	Vo	Tj=25°C	4.8	5.0	5.2	V
		5.0mA<Io<1.0A, Po<15W Vi=7.5V to 20V	4.75	5.00	5.25	V
线性调整率	Δ Vo	Tj=25°C, Vi=7.5V to 25V		4.0	100	mV
		Tj=25°C, Vi=8V to 12V		1.6	50	mV
负载调整率	Δ Vo	Tj=25°C, Io=5.0mA to 1.5A		9	100	mV
		Tj=25°C, Io=250mA to 750mA		4	50	mV
静态电流	IQ	Tj=25°C		5.0	8	mA
静态电流变化率	Δ IQ	Io=5mA to 1.0A		0.03	0.5	mA
		Vi=8V to 25V		0.3	0.8	mA
输出电压温漂	Δ Vo/ Δ T	Io=5mA		0.8		mV/°C
输出噪声电压	VN	f=10Hz to 100kHz, Ta=25°C		42		μ V
纹波抑制比	RR	f=120Hz, Vi=8V to 18V	62	73		dB
输入输出电压差	Vo	Io=1.0A, Tj=25°C		2		V
输出阻抗	Ro	f=1kHz		15		m Ω
短路电流	Isc	Vi=35V, Ta=25°C		230		mA
峰值电流	Ipk	Tj=25°C		2.2		A

WD7806G 电参数(除特别说明, $0 < T_j < 125^\circ\text{C}$, $I_o = 500\text{mA}$, $V_i = 11\text{V}$, $C_i = 0.33\mu\text{F}$, $C_o = 0.1\mu\text{F}$)

参数	符号	测试参数	最小值	典型值	最大值	单位
输出电压	V_o	$T_j = 25^\circ\text{C}$	5.75	6.00	6.25	V
		$5.0\text{mA} < I_o < 1.0\text{A}$, $P_o < 15\text{W}$ $V_i = 8.5\text{V to } 21\text{V}$	5.7	6.0	6.3	V
线性调整率	ΔV_o	$T_j = 25^\circ\text{C}$, $V_i = 8.5\text{V to } 25\text{V}$		5	120	mV
		$T_j = 25^\circ\text{C}$, $V_i = 9\text{V to } 13\text{V}$		1.8	60	mV
负载调整率	ΔV_o	$T_j = 25^\circ\text{C}$, $I_o = 5.0\text{mA to } 1.5\text{A}$		9	130	mV
		$T_j = 25^\circ\text{C}$, $I_o = 250\text{mA to } 750\text{mA}$		4	60	mV
静态电流	I_Q	$T_j = 25^\circ\text{C}$		5.0	8	mA
静态电流变化率	ΔI_Q	$I_o = 5\text{mA to } 1.0\text{A}$			0.5	mA
		$V_i = 9\text{V to } 25\text{V}$			0.8	mA
输出电压温漂	$\Delta V_o / \Delta T$	$I_o = 5\text{mA}$		0.8		mV/ $^\circ\text{C}$
输出噪音电压	V_N	$f = 10\text{Hz to } 100\text{kHz}$, $T_a = 25^\circ\text{C}$		45		μV
纹波抑制比	RR	$f = 120\text{Hz}$, $V_i = 9\text{V to } 19\text{V}$	59	75		dB
输入输出电压差	V_o	$I_o = 1.0\text{A}$, $T_j = 25^\circ\text{C}$		2		V
输出阻抗	R_o	$f = 1\text{kHz}$		19		$\text{m}\Omega$
短路电流	I_{sc}	$V_i = 35\text{V}$, $T_a = 25^\circ\text{C}$		230		mA
峰值电流	I_{pk}	$T_j = 25^\circ\text{C}$		2.2		A

WD7808G 电参数(除特别说明, $0 < T_j < 125^\circ\text{C}$, $I_o = 500\text{mA}$, $V_i = 14\text{V}$, $C_i = 0.33\mu\text{F}$, $C_o = 0.1\mu\text{F}$)

参数	符号	测试参数	最小值	典型值	最大值	单位
输出电压	V_o	$T_j = 25^\circ\text{C}$	7.7	8.0	8.3	V
		$5.0\text{mA} < I_o < 1.0\text{A}$, $P_o < 15\text{W}$ $V_i = 11\text{V to } 23\text{V}$	7.6	8.0	8.4	V
线性调整率	ΔV_o	$T_j = 25^\circ\text{C}$, $V_i = 10.5\text{V to } 25\text{V}$	-	5.0	160	mV
		$T_j = 25^\circ\text{C}$, $V_i = 11\text{V to } 17\text{V}$	-	2.0	80	mV
负载调整率	ΔV_o	$T_j = 25^\circ\text{C}$, $I_o = 5.0\text{mA to } 1.5\text{A}$	-	10	160	mV
		$T_j = 25^\circ\text{C}$, $I_o = 250\text{mA to } 750\text{mA}$	-	5.0	80	mV
静态电流	I_Q	$T_j = 25^\circ\text{C}$	-	5.0	8	mA
静态电流变化率	ΔI_Q	$I_o = 5\text{mA to } 1.0\text{A}$	-	-	0.5	mA
		$V_i = 11\text{V to } 25\text{V}$	-	-	0.8	mA
输出电压温漂	$\Delta V_o / \Delta T$	$I_o = 5\text{mA}$	-	0.8	-	mV/ $^\circ\text{C}$
输出噪音电压	V_N	$f = 10\text{Hz to } 100\text{kHz}$, $T_a = 25^\circ\text{C}$	-	52	-	μV
纹波抑制比	RR	$f = 120\text{Hz}$, $V_i = 11.5\text{V to } 21.5\text{V}$	56	73	-	dB
输入输出电压差	V_o	$I_o = 1.0\text{A}$, $T_j = 25^\circ\text{C}$	-	2	-	V
输出阻抗	R_o	$f = 1\text{kHz}$	-	17	-	$\text{m}\Omega$
短路电流	I_{sc}	$V_i = 35\text{V}$, $T_a = 25^\circ\text{C}$	-	230	-	mA
峰值电流	I_{pk}	$T_j = 25^\circ\text{C}$	-	2.2	-	A

WD7809G 电参数(除特别说明, $0 < T_j < 125^\circ\text{C}$, $I_o = 500\text{mA}$, $V_i = 15\text{V}$, $C_i = 0.33\mu\text{F}$, $C_o = 0.1\mu\text{F}$)

参数	符号	测试参数	最小值	典型值	最大值	单位
输出电压	V_o	$T_j = 25^\circ\text{C}$	8.65	9.00	9.35	V
		$5.0\text{mA} < I_o < 1.0\text{A}$, $P_o < 15\text{W}$ $V_i = 11.5\text{V to } 24\text{V}$	8.6	9.0	9.4	V
线性调整率	ΔV_o	$T_j = 25^\circ\text{C}$, $V_i = 11.5\text{V to } 25\text{V}$	-	6	180	mV
		$T_j = 25^\circ\text{C}$, $V_i = 12\text{V to } 25\text{V}$	-	2	90	mV
负载调整率	ΔV_o	$T_j = 25^\circ\text{C}$, $I_o = 5.0\text{mA to } 1.5\text{A}$	-	12	180	mV
		$T_j = 25^\circ\text{C}$, $I_o = 250\text{mA to } 750\text{mA}$	-	5	90	mV
静态电流	I_Q	$T_j = 25^\circ\text{C}$	-	5.0	8	mA
静态电流变化率	ΔI_Q	$I_o = 5\text{mA to } 1.0\text{A}$	-	-	0.5	mA
		$V_i = 12\text{V to } 26\text{V}$	-	-	0.8	mA
输出电压温漂	$\Delta V_o / \Delta T$	$I_o = 5\text{mA}$	-	1	-	mV/ $^\circ\text{C}$
输出噪音电压	V_N	$f = 10\text{Hz to } 100\text{kHz}$, $T_a = 25^\circ\text{C}$	-	58	-	μV
纹波抑制比	RR	$f = 120\text{Hz}$, $V_i = 13\text{V to } 23\text{V}$	56	71	-	dB
输入输出电压差	V_o	$I_o = 1.0\text{A}$, $T_j = 25^\circ\text{C}$	-	2	-	V
输出阻抗	R_o	$f = 1\text{kHz}$	-	15	-	$\text{m}\Omega$
短路电流	I_{sc}	$V_i = 35\text{V}$, $T_a = 25^\circ\text{C}$	-	230	-	mA
峰值电流	I_{pk}	$T_j = 25^\circ\text{C}$	-	2.2	-	A

WD7810G 电参数(除特别说明, $0 < T_j < 125^\circ\text{C}$, $I_o = 500\text{mA}$, $V_i = 16\text{V}$, $C_i = 0.33\mu\text{F}$, $C_o = 0.1\mu\text{F}$)

参数	符号	测试参数	最小值	典型值	最大值	单位
输出电压	V_o	$T_j = 25^\circ\text{C}$	9.6	10	10.4	V
		$5.0\text{mA} < I_o < 1.0\text{A}$, $P_o < 15\text{W}$ $V_i = 12.5\text{V to } 25\text{V}$	9.5	10	10.5	V
线性调整率	ΔV_o	$T_j = 25^\circ\text{C}$, $V_i = 12.5\text{V to } 25\text{V}$	-	8	200	mV
		$T_j = 25^\circ\text{C}$, $V_i = 13\text{V to } 20\text{V}$	-	3	100	mV
负载调整率	ΔV_o	$T_j = 25^\circ\text{C}$, $I_o = 5.0\text{mA to } 1.5\text{A}$	-	12	200	mV
		$T_j = 25^\circ\text{C}$, $I_o = 250\text{mA to } 750\text{mA}$	-	5	100	mV
静态电流	I_Q	$T_j = 25^\circ\text{C}$	-	5.0	8	mA
静态电流变化率	ΔI_Q	$I_o = 5\text{mA to } 1.0\text{A}$	-	-	0.5	mA
		$V_i = 13\text{V to } 29\text{V}$	-	-	0.8	mA
输出电压温漂	$\Delta V_o / \Delta T$	$I_o = 5\text{mA}$	-	1	-	mV/ $^\circ\text{C}$
输出噪音电压	V_N	$f = 10\text{Hz to } 100\text{kHz}$, $T_a = 25^\circ\text{C}$	-	58	-	μV
纹波抑制比	RR	$f = 120\text{Hz}$, $V_i = 14\text{V to } 24\text{V}$	56	71	-	dB
输入输出电压差	V_o	$I_o = 1.0\text{A}$, $T_j = 25^\circ\text{C}$	-	2	-	V
输出阻抗	R_o	$f = 1\text{kHz}$	-	17	-	$\text{m}\Omega$
短路电流	I_{sc}	$V_i = 35\text{V}$, $T_a = 25^\circ\text{C}$	-	230	-	mA
峰值电流	I_{pk}	$T_j = 25^\circ\text{C}$	-	2.2	-	A

WD7812G 电参数(除特别说明, $0 < T_j < 125^\circ\text{C}$, $I_o = 500\text{mA}$, $V_i = 19\text{V}$, $C_i = 0.33\mu\text{F}$, $C_o = 0.1\mu\text{F}$)

参数	符号	测试参数	最小值	典型值	最大值	单位
输出电压	V_o	$T_j = 25^\circ\text{C}$	11.5	12.0	12.5	V
		$5.0\text{mA} < I_o < 1.0\text{A}$, $P_o < 15\text{W}$ $V_i = 14.5\text{V to } 27\text{V}$	11.4	12	12.6	V
线性调整率	ΔV_o	$T_j = 25^\circ\text{C}$, $V_i = 14.5\text{V to } 30\text{V}$	-	10	240	mV
		$T_j = 25^\circ\text{C}$, $V_i = 16\text{V to } 22\text{V}$	-	3	120	mV
负载调整率	ΔV_o	$T_j = 25^\circ\text{C}$, $I_o = 5.0\text{mA to } 1.5\text{A}$	-	12	240	mV
		$T_j = 25^\circ\text{C}$, $I_o = 250\text{mA to } 750\text{mA}$	-	5.0	120	mV
静态电流	I_Q	$T_j = 25^\circ\text{C}$	-	5.1	8	mA
静态电流变化率	ΔI_Q	$I_o = 5\text{mA to } 1.0\text{A}$	-	-	0.5	mA
		$V_i = 15\text{V to } 30\text{V}$	-	-	0.8	mA
输出电压温漂	$\Delta V_o / \Delta T$	$I_o = 5\text{mA}$	-	1	-	mV/ $^\circ\text{C}$
输出噪音电压	V_N	$f = 10\text{Hz to } 100\text{kHz}$, $T_a = 25^\circ\text{C}$	-	76	-	μV
纹波抑制比	RR	$f = 120\text{Hz}$, $V_i = 15\text{V to } 25\text{V}$	55	71	-	dB
输入输出电压差	V_o	$I_o = 1.0\text{A}$, $T_j = 25^\circ\text{C}$	-	2	-	V
输出阻抗	R_o	$f = 1\text{kHz}$	-	18	-	$\text{m}\Omega$
短路电流	I_{sc}	$V_i = 35\text{V}$, $T_a = 25^\circ\text{C}$	-	230	-	mA
峰值电流	I_{pk}	$T_j = 25^\circ\text{C}$	-	2.2	-	A

WD7815G 电参数(除特别说明, $0 < T_j < 125^\circ\text{C}$, $I_o = 500\text{mA}$, $V_i = 23\text{V}$, $C_i = 0.33\mu\text{F}$, $C_o = 0.1\mu\text{F}$)

参数	符号	测试参数	最小值	典型值	最大值	单位
输出电压	V_o	$T_j = 25^\circ\text{C}$	14.4	15.0	15.6	V
		$5.0\text{mA} < I_o < 1.0\text{A}$, $P_o < 15\text{W}$ $V_i = 17.5\text{V to } 30\text{V}$	14.25	15	15.75	V
线性调整率	ΔV_o	$T_j = 25^\circ\text{C}$, $V_i = 17.5\text{V to } 30\text{V}$	-	11	300	mV
		$T_j = 25^\circ\text{C}$, $V_i = 20\text{V to } 26\text{V}$	-	3	150	mV
负载调整率	ΔV_o	$T_j = 25^\circ\text{C}$, $I_o = 5.0\text{mA to } 1.5\text{A}$	-	12	300	mV
		$T_j = 25^\circ\text{C}$, $I_o = 250\text{mA to } 750\text{mA}$	-	5	150	mV
静态电流	I_Q	$T_j = 25^\circ\text{C}$	-	5.2	8	mA
静态电流变化率	ΔI_Q	$I_o = 5\text{mA to } 1.0\text{A}$	-	-	0.5	mA
		$V_i = 18\text{V to } 30\text{V}$	-	-	0.8	mA
输出电压温漂	$\Delta V_o / \Delta T$	$I_o = 5\text{mA}$	-	1	-	mV/ $^\circ\text{C}$
输出噪音电压	V_N	$f = 10\text{Hz to } 100\text{kHz}$, $T_a = 25^\circ\text{C}$	-	90	-	μV
纹波抑制比	RR	$f = 120\text{Hz}$, $V_i = 18.5\text{V to } 28.5\text{V}$	54	70	-	dB
输入输出电压差	V_o	$I_o = 1.0\text{A}$, $T_j = 25^\circ\text{C}$	-	2	-	V
输出阻抗	R_o	$f = 1\text{kHz}$	-	19	-	$\text{m}\Omega$
短路电流	I_{sc}	$V_i = 35\text{V}$, $T_a = 25^\circ\text{C}$	-	230	-	mA
峰值电流	I_{pk}	$T_j = 25^\circ\text{C}$	-	2.2	-	A

测试电路图



图1 测直流电参数电路图



图2 测负载调整率电路图

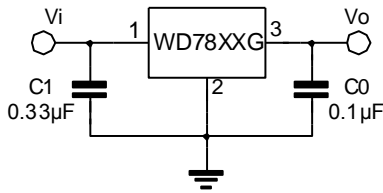

图3 测纹波抑制比电路图

应用电路图

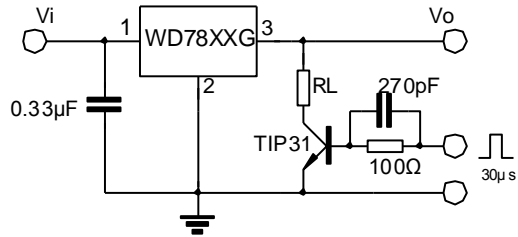

图4 固定输出稳压电路

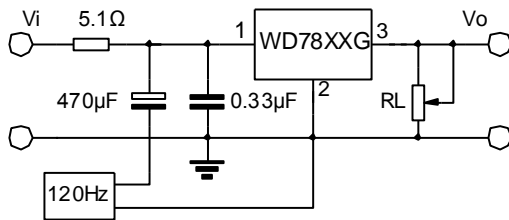

图5 恒流稳压电路

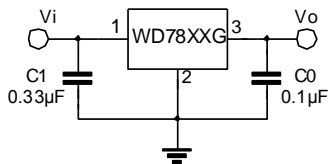

图6 增强型稳压输出电路

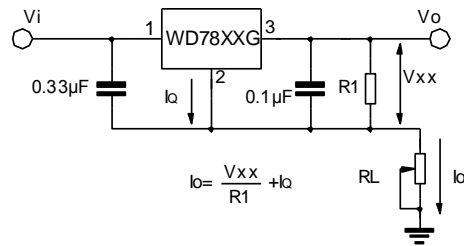

图7 可调型输出电路

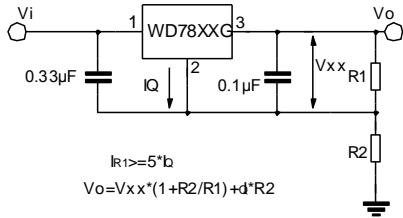

图8 高电流电压稳压电路

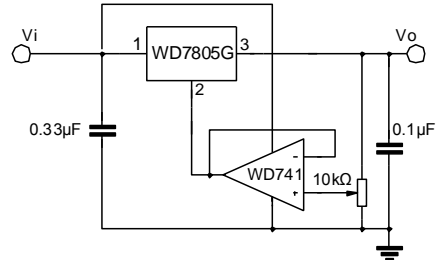

图9 高输出电流短路保护电路

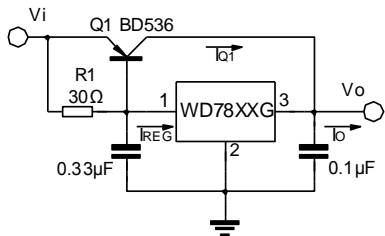

图10 跟踪电压稳压电路

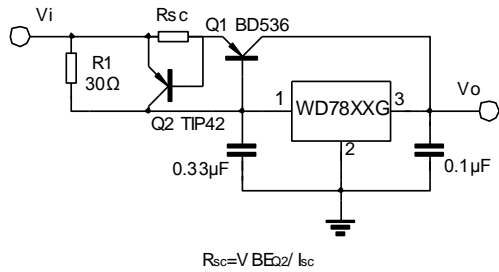

图11 分电源电路(±15V, 1A)

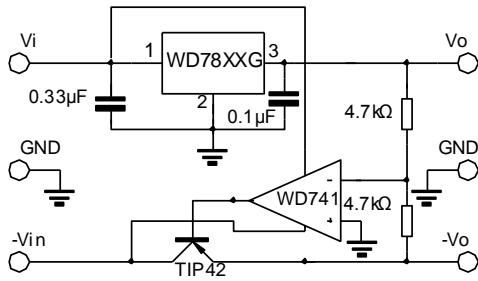

图12 负电源电压输出电路

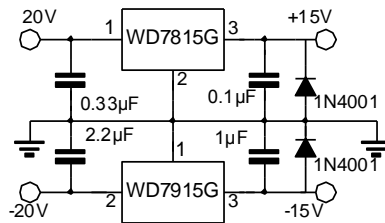

图13 开关稳压电路

典型特性曲线图

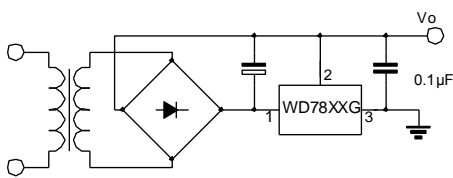
图14 静态电流与结点温度的关系曲线图

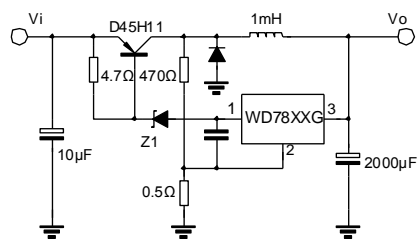

图15 输出电压与结点温度的关系曲线图



图16 峰值输出电流

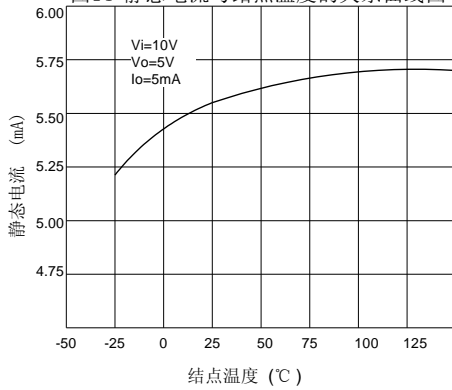

图17 静态电流与输入电压的关系曲线图

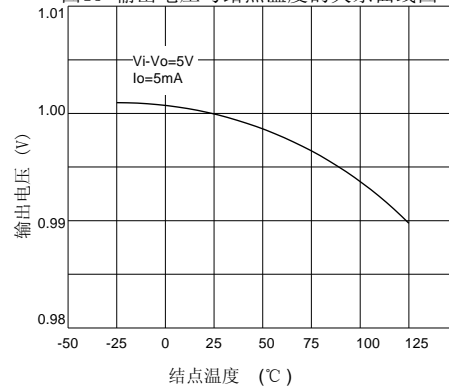

封装外形图

TO-220

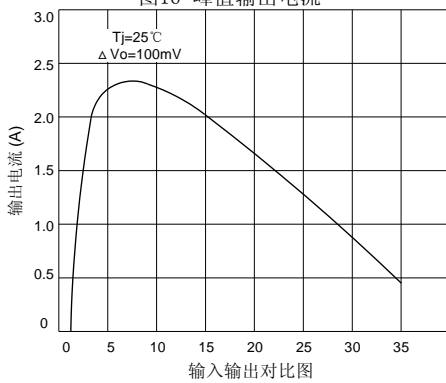
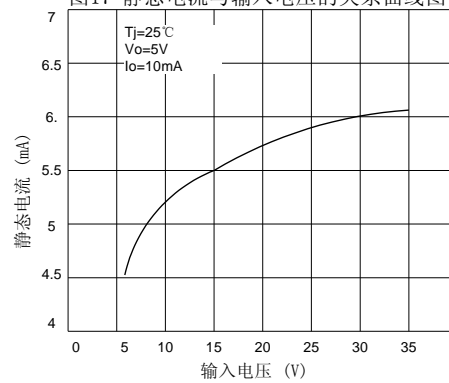
UNIT: mm

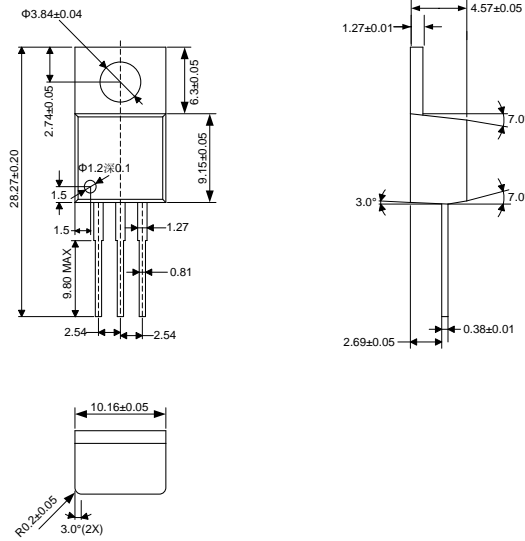

X-ON Electronics

Largest Supplier of Electrical and Electronic Components

Click to view similar products for [Linear Voltage Regulators](#) category:

Click to view products by [Wade Semiconductor](#) manufacturer:

Other Similar products are found below :

[LV5684PVD-XH](#) [MCDTSA6-2R](#) [L7815ACV-DG](#) [LV56801P-E](#) [UA7805CKC](#) [714954EB](#) [ZMR500QFTA](#) [BA033LBSG2-TR](#)
[NCV78M05ABDTRKG](#) [LV5680P-E](#) [L79M05T-E](#) [L78LR05D-MA-E](#) [NCV317MBTG](#) [NTE7227](#) [MP2018GZD-33-P](#) [MP2018GZD-5-P](#)
[LV5680NPVC-XH](#) [ZTS6538SE](#) [UA78L09CLP](#) [UA78L09CLPR](#) [CAT6221-PPTD-GT3](#) [MC78M09CDTRK](#) [NCV51190MNTAG](#)
[BL1118CS8TR1833](#) [BL8077CKETR33](#) [BL9153-33CC3TR](#) [BL9161G-28BADRN](#) [BRCO7530MMC](#) [CJ7815B-TFN-ARG](#) [LM317C](#)
[GM7333K](#) [GM7350K](#) [XC6206P332MR](#) [HT7533](#) [LM7912S/TR](#) [LT1764S/TR](#) [LM7805T](#) [LM338T](#) [LM1117IMP-3.3/TR](#) [HT1117AM-3.3](#)
[HT7550S](#) [AMS1117-3.3](#) [HT7150S](#) [78L12](#) [HT7550](#) [HT7533-1](#) [HXY6206I-2.5](#) [HT7133](#) [HT7533S](#) [662K](#)