

### ■ Description

The WD78L05 series are three terminal positive regulators. These regulators can provide local on card regulation, eliminating the distribution problems associated with single point regulation. The WD78L05 can be used in logic systems, instrumentation, HiFi, and other solid state electronic equipment. When used as a Zener diode/resistor combination replacement, the WD78L05 usually results in an effective output impedance improvement of two orders of magnitude, and lower quiescent current. With adequate heat sinking, the WD78L05 can deliver 100mA output current. Current limiting is included to limit the peak output current to a safe value. Thermal protection is also provided. If internal power dissipation becomes too high for the heat sinking provided, the thermal shutdown circuit takes over, preventing the IC from overheating.

The WD78L05 are available in the plastic TO-92, SOIC-8, SOT-223 and SOT-89 packages.

### ■ Features and Benefits

- Output Current up to 100mA
- Output Voltage Tolerances of  $\pm 5\%$  over the Full Temperature Range
- Internal Short Circuit Current-limiting
- Internal Thermal Overload Protection
- No External Components

### ■ Applications

- High Efficiency Linear Regulator
- Post Regulation for Switching Supply
- Microprocessor Power Supply
- Mother Board I/O Power Supply

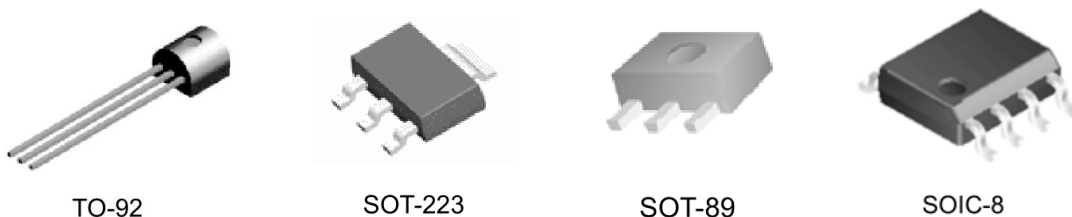

Figure 1. Package Type of WD78L05

### Pin Configuration

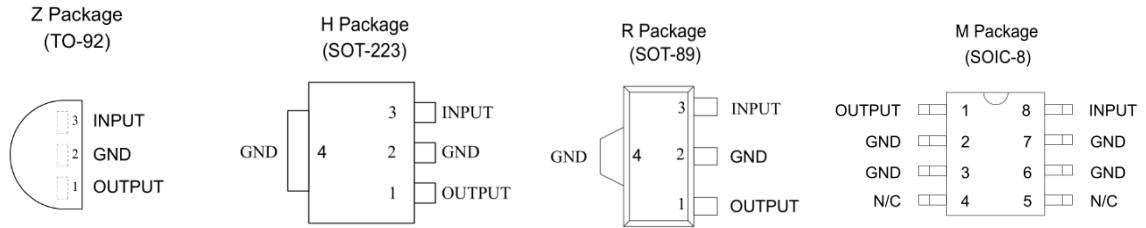

Figure 2. Pin Configuration of WD78L05(Top View)

### Pin Description

Pin No.				Symbol	Function
Z	H	R	M		
1	1	1	1	Output	Output Voltage pin
2	2, 4	2, 4	2, 3, 6, 7	GND	Ground
3	3	3	8	Input	Input Voltage pin

### Functional Block Diagram

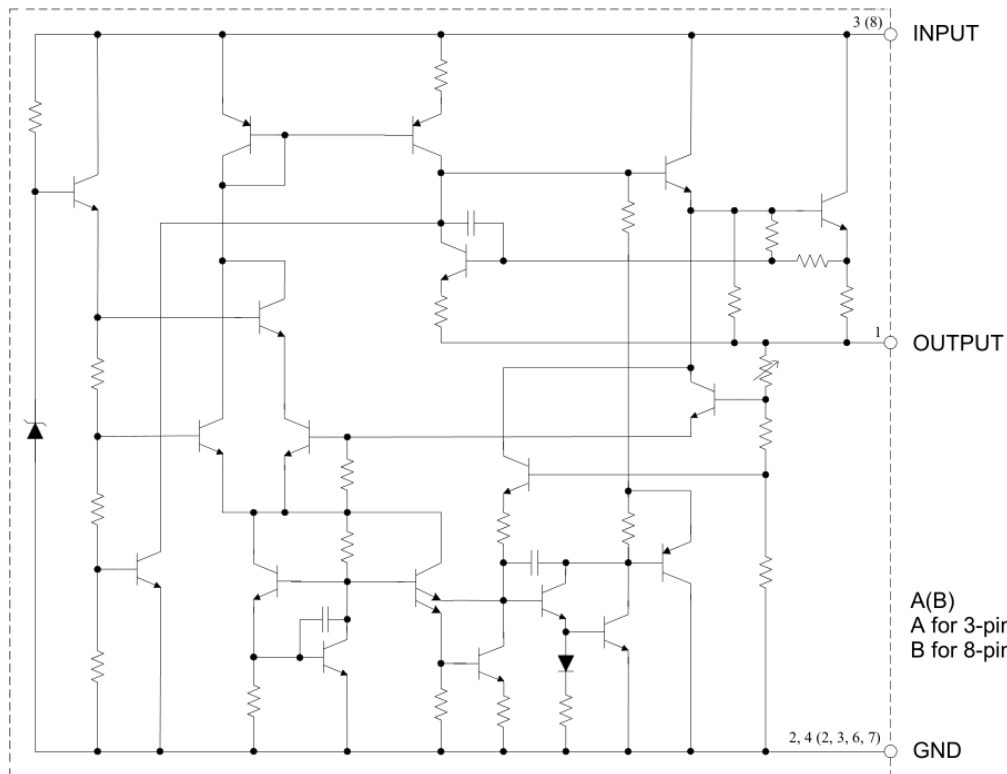
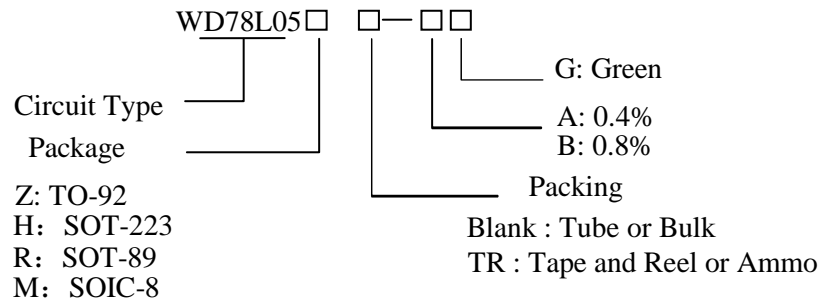

Figure 3. Functional Block Diagram of WD78L05

### Ordering Information



Package	Temperature Range	Voltage Tolerance	Part Number	Marking ID	Packing Type
			Green	Green	
TO-92	-40 to 125°C	0.40%	WD78L05Z-AG	WD78L05	Bulk
		0.80%	WD78L05Z-BG	WD78L05	
		0.40%	WD78L05ZTR-AG	WD78L05	Ammo
		0.80%	WD78L05ZTR-BG	WD78L05	
SOT-223	-40 to 125°C	0.40%	WD78L05HTR-AG	WD78L05	Tape and Reel
		0.80%	WD78L05HTR-BG	WD78L05	
SOT-89	-40 to 125°C	0.40%	WD78L05RTR-AG	WD78L05	Tape and Reel
		0.80%	WD78L05RTR-BG	WD78L05	
SOIC-8	-40 to 125°C	0.40%	WD78L05M-AG	WD78L05	Tube
		0.80%	WD78L05M-BG	WD78L05	
		0.40%	WD78L05MTR-AG	WD78L05	Tape and Reel
		0.80%	WD78L05MTR-BG	WD78L05	

WADE's Products with "G" suffix are available in green package. are RoHS compliant.

### ■ Absolute Maximum Ratings (Ta= 25°C)

Parameter	Symbol	Value		Unit
Power Supply Voltage	V <sub>CC</sub>	30		V
Power Dissipation (T <sub>A</sub> = 25 °C)	P <sub>D</sub>	TO-92	0.65	W
		SOT-223	0.7	
		SOT-89	0.65	
		SOIC-8	0.6	
Thermal Resistance	θ <sub>JA</sub>	TO-92	81	°C/W
		SOT-223	71	
		SOT-89	29.8	
		SOIC-8	160	
Operating Junction Temperature	T <sub>J</sub>	150		°C
Lead Temperature (Soldering, 10s)	T <sub>LEAD</sub>	260		°C
Storage Temperature Range	T <sub>STG</sub>	-65 to +150		°C
ESD (Human Body Model)	—	2000		V
ESD (Machine Model)	—	200		V

Note 1: Stresses greater than those listed under “Absolute Maximum Ratings” may cause permanent damage to the device. These are stress ratings only, and functional operation of the device at these or any other conditions beyond those indicated under “Recommended Operating Conditions” is not implied. Exposure to “Absolute Maximum Ratings” for extended periods may affect device reliability.

### ■ Recommended Operating Conditions (T<sub>A</sub>=25 °C)

Parameter	Symbol	Min	Max	Unit
Power Supply Voltage	V <sub>CC</sub>		15	V
Operating Temperature	T <sub>A</sub>	-40	125	°C

### ■ Electrical Characteristics

$I_{OUT} = 40\text{mA}$ ,  $C_{IN} = 0.33\ \mu\text{F}$ ,  $C_{OUT} = 0.1\ \mu\text{F}$ ,  $V_{IN} = 10\text{V}$ ,  $T_A = 25\ ^\circ\text{C}$ , unless otherwise specified.

Parameter	Symbol	Conditions	Min	Typ	Max	Unit
Quiescent Current	$I_Q$	$I_{OUT} = 0$		3	5	mA
Quiescent Current Change	$\Delta I_Q$	$8.0\text{V} \leq V_{IN} \leq 15\text{V}$			1	mA
		$1.0\text{mA} \leq I_{OUT} \leq 40\text{mA}$			0.1	mA
Output Voltage	$V_{OUT}$	---	4.8	5	5.2	V
		$7.0\text{V} \leq V_{IN} \leq 15\text{V}$ $1.0\text{mA} \leq I_{OUT} \leq 40\text{mA}$	4.75		5.25	V
Line Regulation	$V_{RLINE}$	$7.0\text{V} \leq V_{IN} \leq 15\text{V}$		18	75	mV
Load Regulation	$V_{RLOAD}$	$1.0\text{mA} \leq I_{OUT} \leq 100\text{mA}$		20	60	mV
Dropout Voltage	$V_{DROP}$	---		1.6		V
Current Limit	$I_{LIMIT}$	---		150		mA
Output Noise Voltage	$N_O$	$10\text{Hz} \leq f \leq 100\text{kHz}$		40		$\mu\text{V}$
Ripple Rejection	PSRR	$f = 120\text{Hz}$ , $8.0\text{V} \leq V_{IN} \leq 15\text{V}$	47	62		dB
Peak Output Current	$I_{PK}$	---		150		mA
Average Temperature Coefficient	$\Delta V_{OUT} / \Delta T$	$I_{OUT} = 5\text{mA}$		0.65		mV/ $^\circ\text{C}$
Minimum Value of Input Voltage	$V_{IN(\text{Min})}$	---		6.7	7	V

### Typical Performance Characteristics

$V_{CC} = 5.0V$ ,  $T_A = 25^\circ C$ , unless otherwise specified.

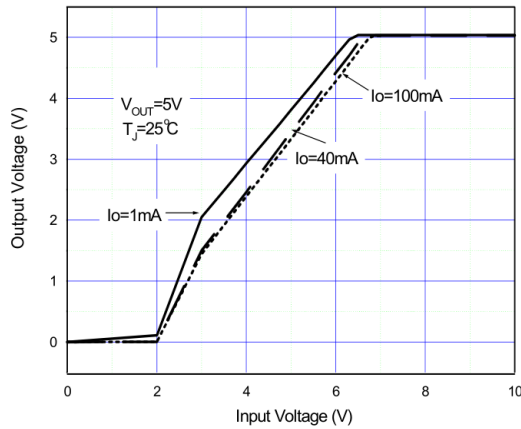

Figure 4. Dropout Characteristics

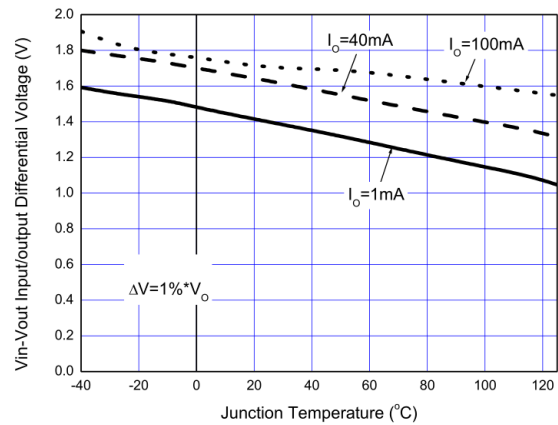

Figure 5. Dropout Voltage vs. Junction Temperature

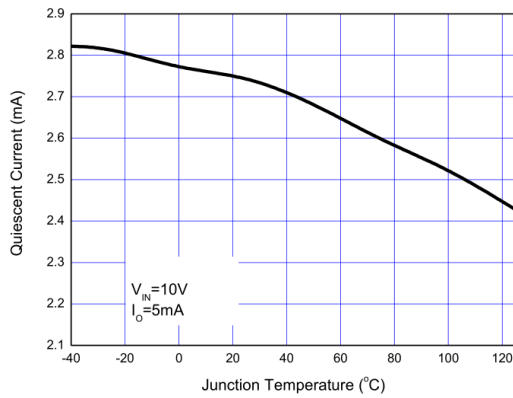

Figure 6. Quiescent Current vs. Junction Temperature

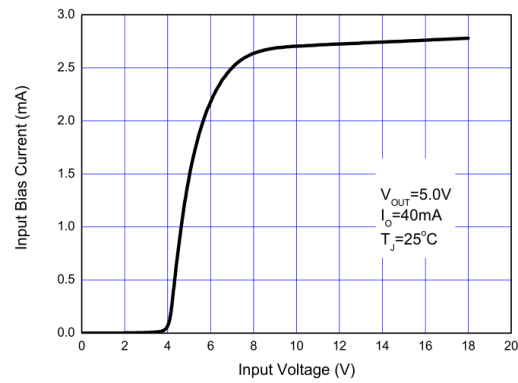

Figure 7. Input Bias Current vs. Input Voltage

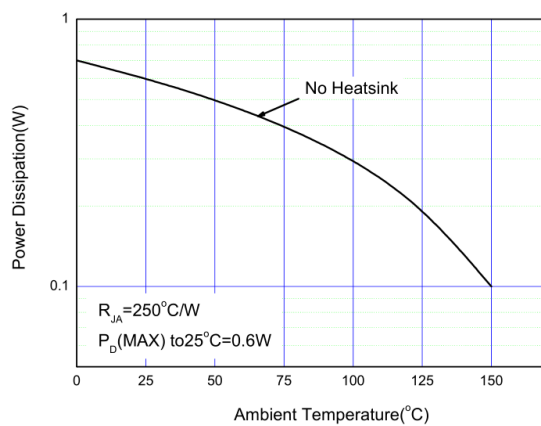

Figure 8. Maximum Power Dissipation vs. Ambient Temperature (SOIC-8 Package)

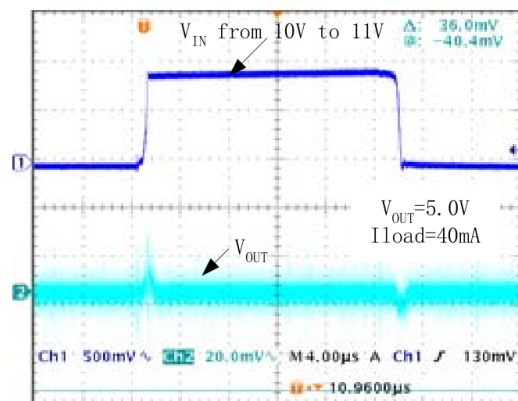

Figure 9. Line Transient Response

**Typical Performance Characteristics (Continued)**

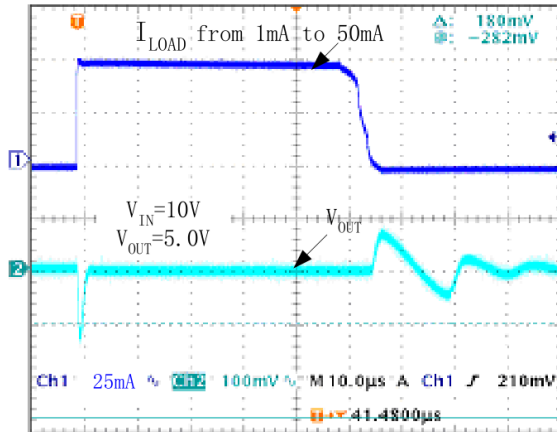

Figure 10. Load Transient Response

**Typical Applications Circuit**

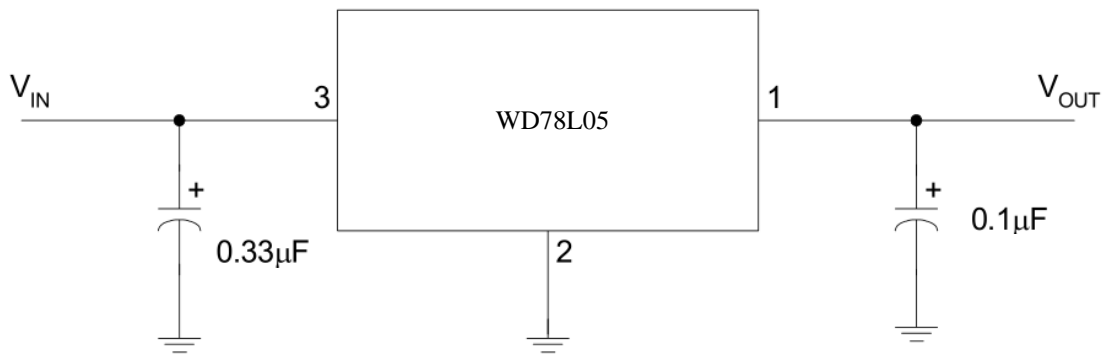
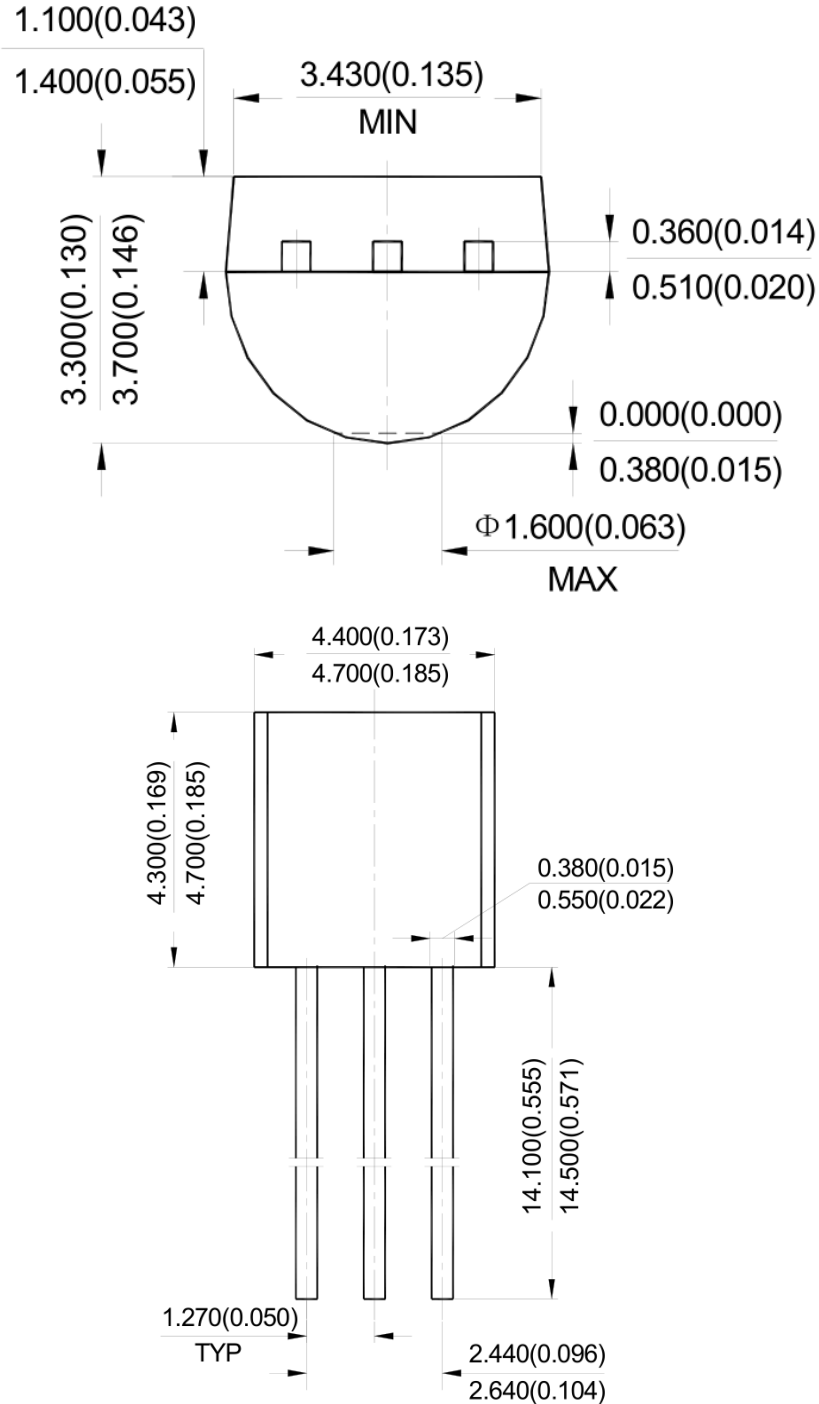

Figure 11. Typical Application of the WD78L05

**Package Outline Dimensions**

**TO-92**

**Unit: mm(inch)**







■ Package Outline Dimensions(Continued)

**SOT-223**

**Unit: mm(inch)**

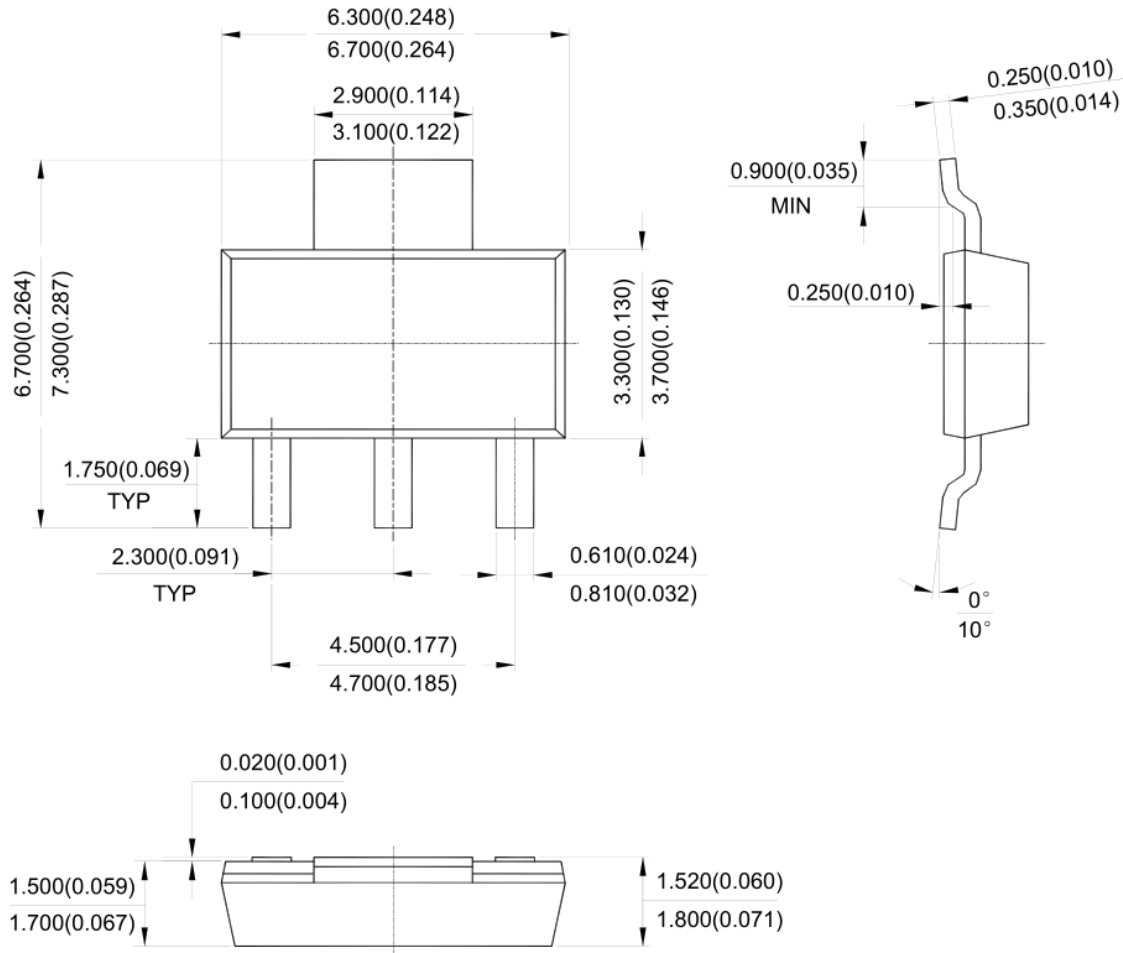



## X-ON Electronics

Largest Supplier of Electrical and Electronic Components

*Click to view similar products for [Linear Voltage Regulators](#) category:*

*Click to view products by [Wade Semiconductor](#) manufacturer:*

Other Similar products are found below :

[LV5684PVD-XH](#) [MCDTSA6-2R](#) [L7815ACV-DG](#) [LV56801P-E](#) [UA7805CKC](#) [714954EB](#) [ZMR500QFTA](#) [BA033LBSG2-TR](#)  
[NCV78M05ABDTRKG](#) [LV5680P-E](#) [L79M05T-E](#) [L78LR05D-MA-E](#) [NCV317MBTG](#) [NTE7227](#) [MP2018GZD-33-P](#) [MP2018GZD-5-P](#)  
[LV5680NPVC-XH](#) [ZTS6538SE](#) [UA78L09CLP](#) [UA78L09CLPR](#) [CAT6221-PPTD-GT3](#) [MC78M09CDTRK](#) [NCV51190MNTAG](#)  
[BL1118CS8TR1833](#) [BL8077CKETR33](#) [BL9153-33CC3TR](#) [BL9161G-28BADRN](#) [BRCO7530MMC](#) [CJ7815B-TFN-ARG](#) [LM317C](#)  
[GM7333K](#) [GM7350K](#) [XC6206P332MR](#) [HT7533](#) [LM7912S/TR](#) [LT1764S/TR](#) [LM7805T](#) [LM338T](#) [LM1117IMP-3.3/TR](#) [HT1117AM-3.3](#)  
[HT7550S](#) [AMS1117-3.3](#) [HT7150S](#) [78L12](#) [HT7550](#) [HT7533-1](#) [HXY6206I-2.5](#) [HT7133](#) [HT7533S](#) [662K](#)