

# 1 Sensor and Actuator Terminal Blocks 2000 Series

## 6 Commoning: Signal Level

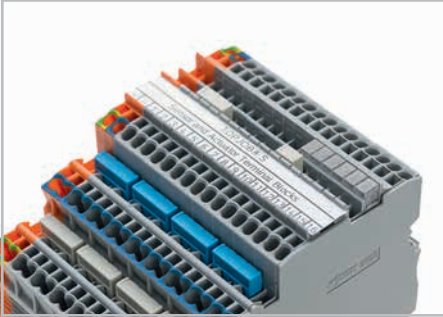

Commoning the signal level with push-in type jumper bars (2000 Series); models with an LED can only be commoned in one jumper slot! TOPJOB® S test plug adapter can be used in all jumper slots.



Upper level: two independent signal pathways

## Commoning: Potential Level



Commoning potential levels via push-in type jumper bars (2000 Series).

## Power Supply

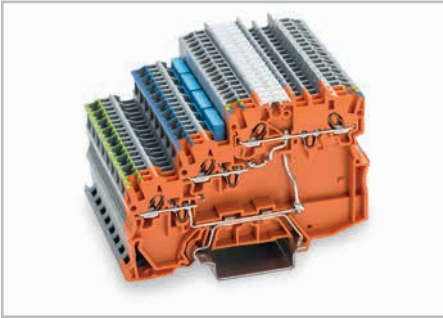

Orange supply terminal block of same profile with a power supply option from both the cabinet and sensor sides

## Marking System

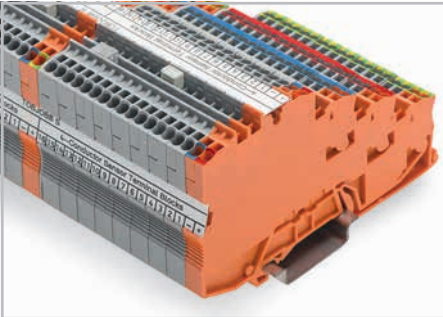

Marking strips (2009-110), marking from the top or the side

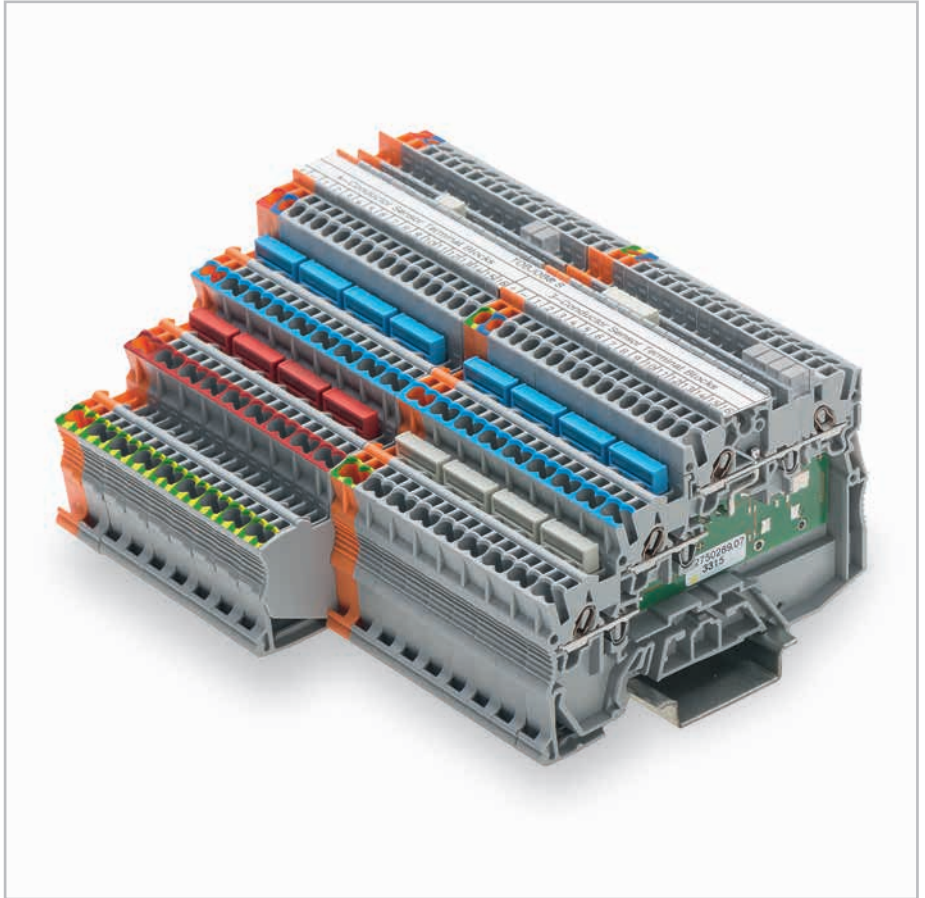

Terminal block assembly with 4-conductor sensor terminal blocks and 3-conductor actuator terminal blocks

## Marking System

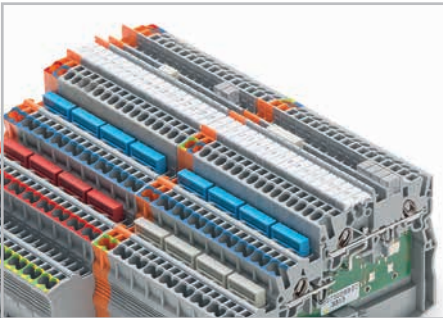

WMB markers 3.5 mm (793-35xx), marking from the top or the side, additional marking option via marker carrier

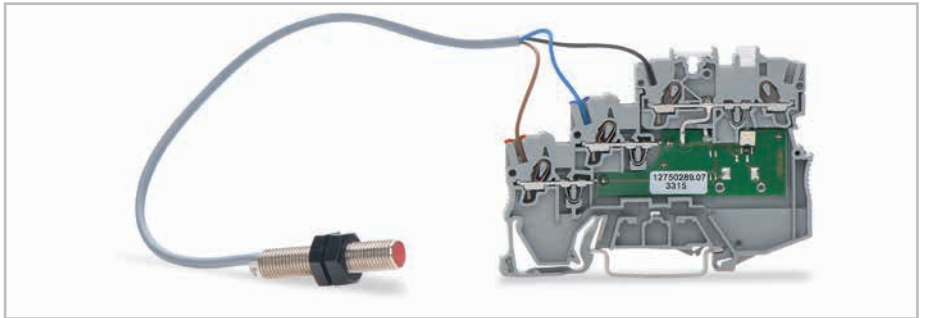

3-conductor sensor LED terminal block with a connected sensor



Push-in CAGE CLAMP® terminates the following copper conductors:\*

solid



stranded



fine-stranded, also with tinned single strands

\* For aluminum conductors, see notes in Full Line Catalog, Volume 1, Section 14.

❶ When using ferrules, the max. conductor cross section accommodated is one size smaller than max. rating of terminal block.

## - Description and Handling -

### Commoning: Potential Level



Continuous commoning in the potential levels via push-in type jumper bars for even pole numbers (2000 Series)

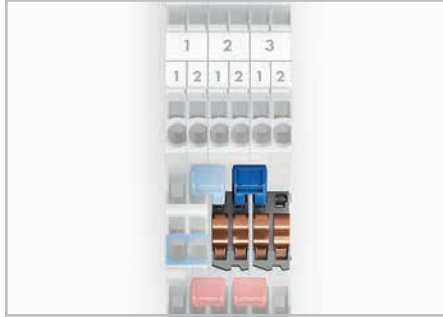

Potential levels: two adjacent commoning options on a current bar

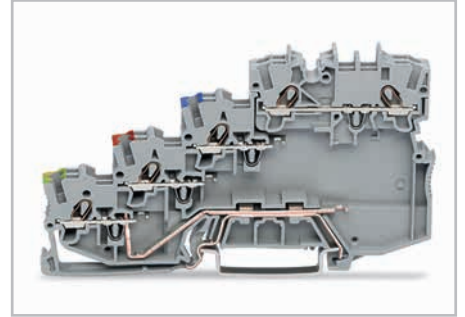

4-conductor sensor terminal block with ground contact

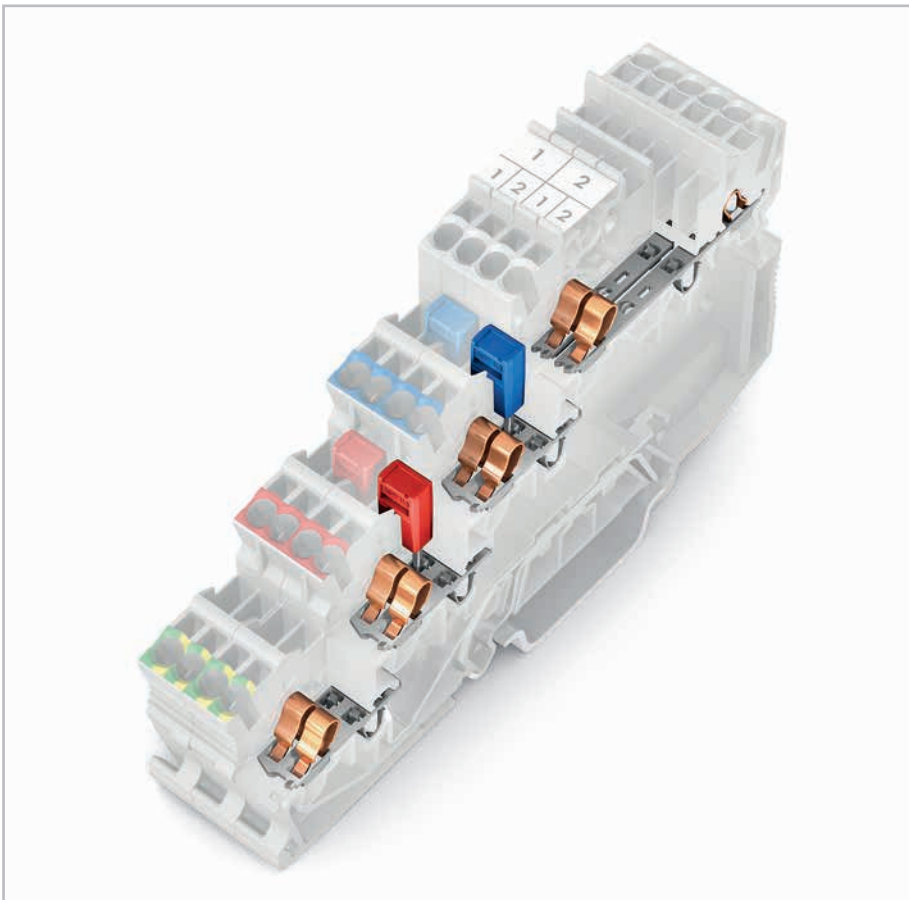

Upper level: two independent signal pathways, in 3.5 mm pin spacing, with a dual jumper slot  
Lower levels: two interconnected potential clamping units, with a single jumper slot, can be commoned in both directions

### Ground Commoning

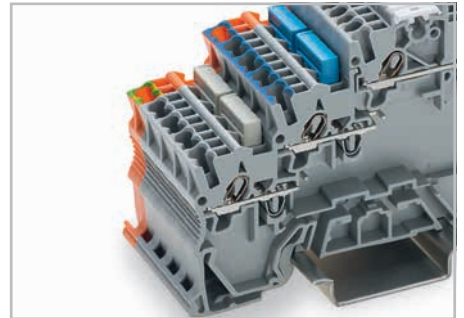

For sensor and actuator terminal blocks without ground connection to the DIN-rail, the ground connection can be performed by commoning to the terminal block with a ground foot.

### Testing

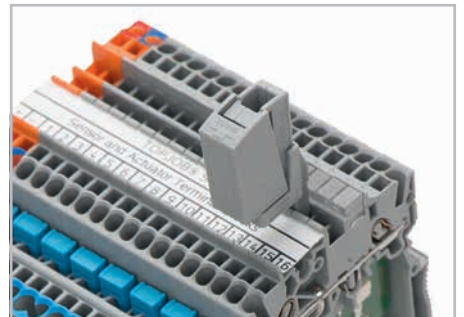

Testing via testing tap (2009-182) (up to max. 42 V)

### Testing

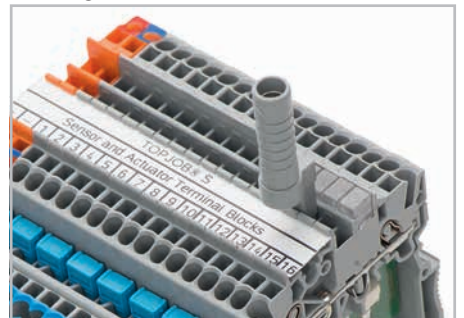

Testing via test plug adapter (2009-174) (up to max. 42 V)

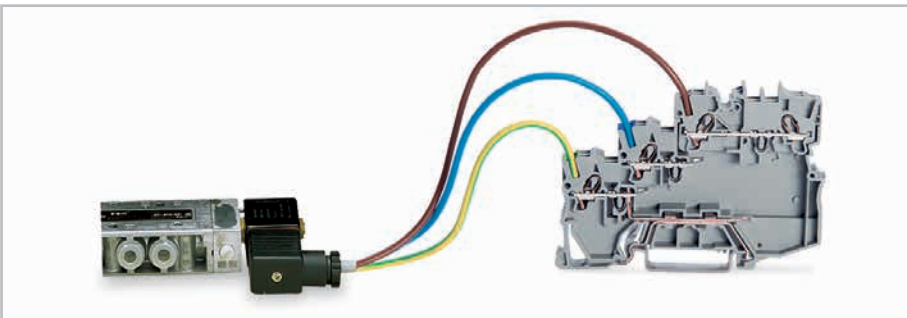

3-conductor actuator LED terminal block with a connected actuator



fine-stranded, tip-bonded



fine-stranded, with ferrule ① (gas-tight crimped)



fine-stranded, with pin terminal (gas-tight crimped)



# TOPJOB® S

## 3-Conductor Sensor Terminal Blocks 1 (1.5) mm<sup>2</sup>

### 2000 Series

0.14 ... 1 (1.5) mm <sup>2</sup> ① 250 V/4 kV/3 ② I <sub>N</sub> 13.5 A	AWG 24 ... 16 300 V, 10 A	0.14 ... 1 (1.5) mm <sup>2</sup> ① 24 VDC I <sub>N</sub> 13.5 A	AWG 24 ... 16 24 VDC, 10 A
Terminal block width 7 mm / 0.276 in ③ 9 ... 11 mm / 0.39 in ④		Terminal block width 7 mm / 0.276 in ③ 9 ... 11 mm / 0.39 in ④	

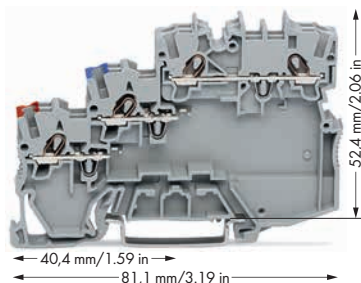

2000-5311

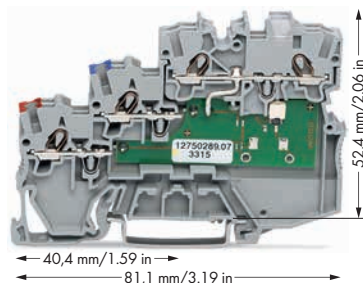
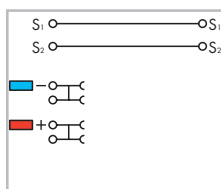

2000-5311/1102-950

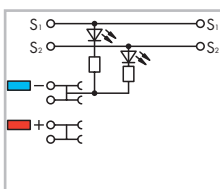

2000-5311/1101-951

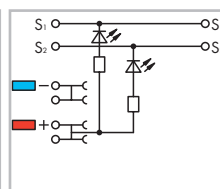

Item No.	Pack. Unit	Item No.	Pack. Unit
<b>3-conductor sensor terminal block</b>		<b>3-conductor sensor LED terminal block, for PNP (high-side) switching sensors, yellow LED</b>	
gray 2000-5311	50	gray 2000-5311/1102-950	50
		<b>3-conductor sensor LED terminal block, for NPN (low-side) switching sensors, yellow LED</b>	
		gray 2000-5311/1101-951	50

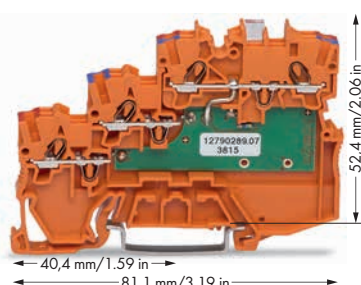

2000-5372/1102-953

2000-5372

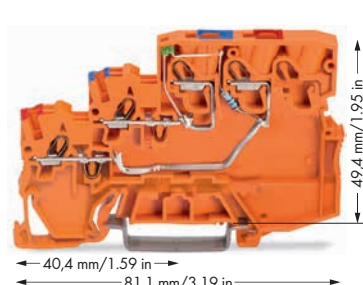
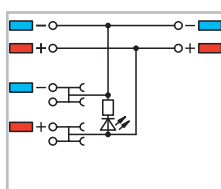

2000-5352/1102-953

2000-5352

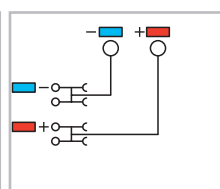
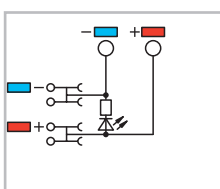

Item No.	Pack. Unit	Item No.	Pack. Unit
<b>3-conductor sensor LED supply terminal block, 24 VDC, green LED</b>		<b>3-conductor sensor LED supply terminal block, 24 VDC, green LED, control panel side: 2.5 (4) mm<sup>2</sup>, max. 28 A</b>	
orange 2000-5372/1102-953	15	orange 2000-5352/1102-953	15
<b>3-conductor sensor supply terminal block, max. 250 V, internal bridge</b>		<b>3-conductor sensor supply terminal block, max. 250 V, control panel side: 2.5 (4) mm<sup>2</sup>, max. 28 A</b>	
orange 2000-5372	15	orange 2000-5352	15

## PUSH-IN CAGE CLAMP®

### Note:

The double pin spacing of this terminal block series maximizes connectivity. For example ten sensors may be connected using only five sensor terminal blocks plus power supply terminal block.

- ① Conductor sizes: 0.14 mm<sup>2</sup> ... 1.5 mm<sup>2</sup> "s + f-st"; Push-in conductor sizes: 0.5 mm<sup>2</sup> ... 1.5 mm<sup>2</sup> "s" and 0.5 mm<sup>2</sup> ... 0.75 mm<sup>2</sup> "insulated ferrule, 10 mm"
- ② 250 V = rated voltage  
4 kV = rated surge voltage  
3 = pollution degree  
(see Full Line Catalog, Volume 1, Section 14)
- ③ 3.5 mm pin spacing per signal (2 x 3.5 mm = 7 mm)
- ④ Strip length, see packaging or instructions.
- ⑤ See application notes in Full Line Catalog, Volume 1, for:  
Colored push-in type jumper bars, page 101  
Push-in type wire jumper, page 102

### Accessories for 4-Conductor Terminal Blocks WMB/Marking strips (see Full Line Catalog, Volume 1, Section 13)

<b>End and intermediate plate, 1 mm thick, for 3-conductor terminal blocks</b>	
gray	2000-5391 100 (4x25)

<b>Push-in type jumper bar, insulated, I<sub>N</sub> 14 A, light gray</b>	
2-way	2000-402 200 (8x25)
3-way	2000-403 200 (8x25)
4-way	2000-404 200 (8x25)
5-way	2000-405 100 (4x25)
6-way	2000-406 100 (4x25)
7-way	2000-407 100 (4x25)
8-way	2000-408 100 (4x25)
9-way	2000-409 100 (4x25)
10-way	2000-410 100 (4x25)

<b>Colored push-in type jumper bars, I<sub>N</sub> 14 A, light gray</b>	
red	.../000-005
blue	.../000-006
yellow-green	

<b>Push-in type jumper bar, insulated, I<sub>N</sub> 14 A, light gray</b>	
from 1 to 3	2000-433 200 (8x25)
from 1 to 4	2000-434 200 (8x25)
from 1 to 5	2000-435 100 (4x25)
from 1 to 6	2000-436 100 (4x25)
from 1 to 7	2000-437 100 (4x25)
from 1 to 8	2000-438 100 (4x25)
from 1 to 9	2000-439 100 (4x25)
from 1 to 10	2000-440 100 (4x25)

<b>Double-deck marker carrier, pivoting, gray</b>	
	2000-121 50 (2x25)

<b>Marking strip, plain, 11 mm wide, 50 m roll, white</b>	
	2009-110 1

<b>WMB Multi marking system, 10 strips with 10 markers per card, for 3.5 mm terminal block width, plain</b>	
	793-3501 5

<b>Operating tool with a partially insulated shaft, type 1, (2.5 x 0.4) mm blade</b>	
	210-719 1

# TOPJOB® S

## 4-Conductor Sensor Terminal Blocks 1 (1.5) mm<sup>2</sup>

### 2000 Series

# PUSH-IN CAGE CLAMP®

0.14 ... 1 (1.5) mm <sup>2</sup> ① 250 V/4 kV/3 ② I <sub>N</sub> 13.5 A	AWG 24 ... 16 300 V, 10 A	0.14 ... 1 (1.5) mm <sup>2</sup> ① 24 VDC I <sub>N</sub> 13.5 A	AWG 24 ... 16 24 VDC, 10 A
Terminal block width 7 mm / 0.276 in ③ 9 ... 11 mm / 0.39 in ④		Terminal block width 7 mm / 0.276 in ③ 9 ... 11 mm / 0.39 in ④	

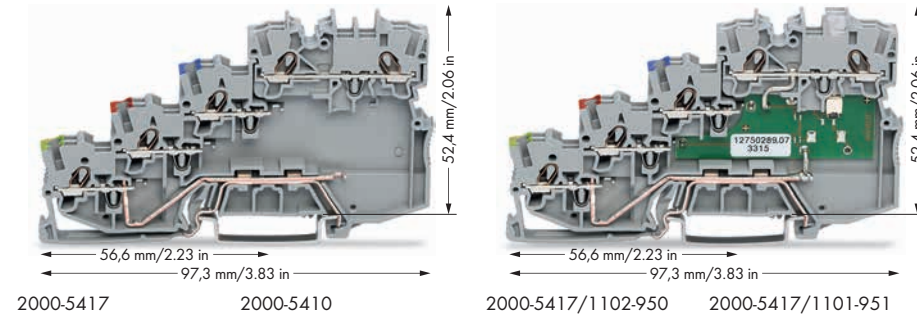

Item No.	Pack. Unit	Item No.	Pack. Unit
<b>4-conductor sensor terminal block</b>		<b>4-conductor sensor LED terminal block, for PNP (high-side) switching sensors, yellow LED</b>	
gray	2000-5417	50	gray
gray	2000-5410	50 ⑥	gray
		<b>4-conductor sensor LED terminal block, for NPN (low-side) switching sensors, yellow LED</b>	
		gray	2000-5417/1101-951
		50	gray
		2000-5410/1101-951	50 ⑥

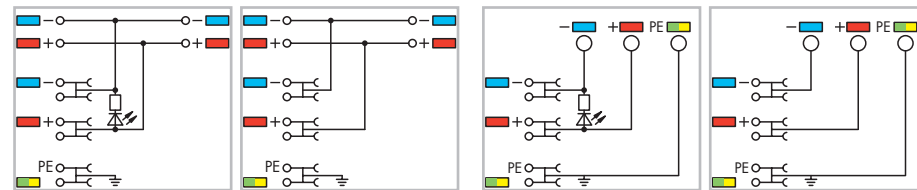
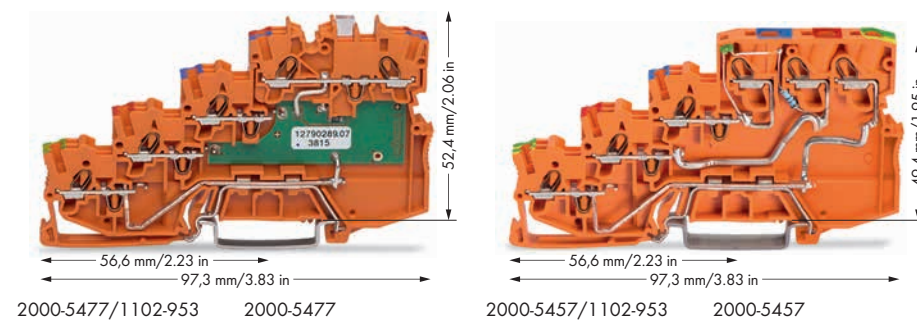

Item No.	Pack. Unit	Item No.	Pack. Unit
<b>4-conductor sensor LED supply terminal block, 24 VDC, green LED</b>		<b>4-conductor sensor LED supply terminal block, 24 VDC, green LED, control panel side: 2.5 (4) mm<sup>2</sup>, max. 28 A</b>	
orange	2000-5477/1102-953	15	orange
		<b>4-conductor sensor supply terminal block, max. 250 V, internal bridge</b>	
orange	2000-5477	15	orange
		<b>4-conductor sensor supply terminal block, max. 250 V, control panel side: 2.5 (4) mm<sup>2</sup>, max. 28 A</b>	
		2000-5457	15

**Note:**  
The double pin spacing of this terminal block series maximizes connectivity. For example ten sensors may be connected using only five sensor terminal blocks plus power supply terminal block.

① Conductor sizes: 0.14 mm<sup>2</sup> ... 1.5 mm<sup>2</sup> "s + fst"; Push-in conductor sizes: 0.5 mm<sup>2</sup> ... 1.5 mm<sup>2</sup> "s" and 0.5 mm<sup>2</sup> ... 0.75 mm<sup>2</sup> "insulated ferrule, 10 mm"

② 250 V = rated voltage  
4 kV = rated surge voltage  
3 = pollution degree  
(see Full Line Catalog, Volume 1, Section 14)

③ 3.5 mm pin spacing per signal (2 x 3.5 mm = 7 mm)

④ Strip length, see packaging or instructions.

⑤ See application notes in Full Line Catalog, Volume 1, for:  
Colored push-in type jumper bars, page 101  
Push-in type wire jumper, page 102

⑥ Ground connection via commoning to terminal blocks with ground foot

### Accessories for 4-Conductor Terminal Blocks WMB/Marking strips

(see Full Line Catalog, Volume 1, Section 13)

<b>End and intermediate plate, 1 mm thick,</b>	for 4-conductor terminal blocks
gray	2000-5491 100 (4x25)

<b>Push-in type jumper bar, insulated,</b>	I <sub>N</sub> 14 A, light gray
⑤	2-way 2000-402 200 (8x25)
	3-way 2000-403 200 (8x25)
	4-way 2000-404 200 (8x25)
	5-way 2000-405 100 (4x25)
	6-way 2000-406 100 (4x25)
	7-way 2000-407 100 (4x25)
	8-way 2000-408 100 (4x25)
	9-way 2000-409 100 (4x25)
	10-way 2000-410 100 (4x25)

<b>Colored push-in type jumper bars,</b>	
red	.../000-005
blue	.../000-006
yellow-green	.../000-018

<b>Push-in type jumper bar, insulated,</b>	I <sub>N</sub> 14 A, light gray
	from 1 to 3 2000-433 200 (8x25)
	from 1 to 4 2000-434 200 (8x25)
	from 1 to 5 2000-435 100 (4x25)
	from 1 to 6 2000-436 100 (4x25)
	from 1 to 7 2000-437 100 (4x25)
	from 1 to 8 2000-438 100 (4x25)
	from 1 to 9 2000-439 100 (4x25)
	from 1 to 10 2000-440 100 (4x25)

<b>Double-deck marker carrier,</b>	pivoting
gray	2000-121 50 (2x25)

<b>Marking strip, plain,</b>	11 mm wide, 50 m roll
white	2009-110 1

<b>WMB Multi marking system,</b>	10 strips with 10 markers per card, for 3.5 mm terminal block width
plain	793-3501 5

<b>Operating tool with a partially insulated shaft,</b>	type 1, (2.5 x 0.4) mm blade
	210-719 1

# TOPJOB® S 3-Conductor Actuator Terminal Blocks 1 (1.5) mm<sup>2</sup> 2000 Series

0.14 ... 1 (1.5) mm <sup>2</sup> ① 250 V/4 kV/3 ② I <sub>N</sub> 13.5 A	AWG 24 ... 16 300 V, 10 A	0.14 ... 1 (1.5) mm <sup>2</sup> ① 24 VDC I <sub>N</sub> 13.5 A	AWG 24 ... 16 24 VDC, 10 A
Terminal block width 7 mm / 0.276 in ③ 9 ... 11 mm / 0.39 in ④		Terminal block width 7 mm / 0.276 in ③ 9 ... 11 mm / 0.39 in ④	

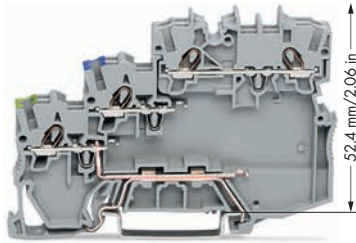

40,4 mm / 1.59 in  
81,1 mm / 3.19 in

2000-5317/102-000    2000-5310/101-000

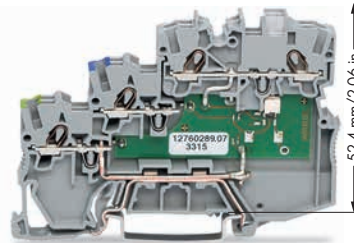
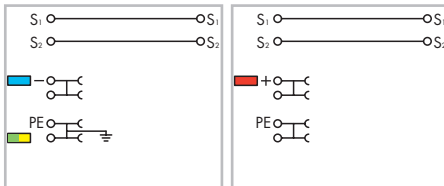

40,4 mm / 1.59 in  
81,1 mm / 3.19 in

2000-5317/1102-950    2000-5310/1101-951

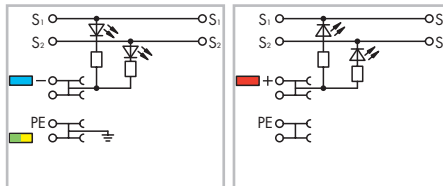

Item No.	Pack. Unit	Item No.	Pack. Unit
<b>3-conductor actuator terminal block, for PNP (high-side) switching actuators, with ground connection</b>		<b>3-conductor actuator LED terminal block, for PNP (high-side) switching actuators, yellow LED, with ground connection</b>	
gray	2000-5317/102-000 50	gray	2000-5317/1102-950 50
gray	2000-5310/102-000 50 ⑥	gray	2000-5310/1102-950 50 ⑥
<b>3-conductor actuator terminal block, for NPN (low-side) switching actuators</b>		<b>3-conductor actuator LED terminal block, for NPN (low-side) switching actuators, yellow LED</b>	
gray	2000-5317/101-000 50	gray	2000-5317/1101-951 50
gray	2000-5310/101-000 50 ⑥	gray	2000-5310/1101-951 50 ⑥

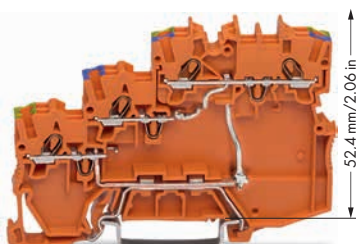

40,4 mm / 1.59 in  
81,1 mm / 3.19 in

2000-5377/102-000    2000-5377/101-000

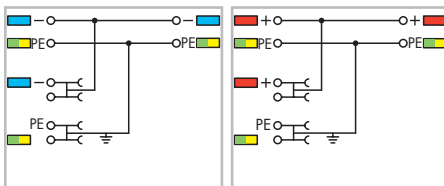

40,4 mm / 1.59 in  
81,1 mm / 3.19 in

2000-5357/102-000    2000-5357/101-000

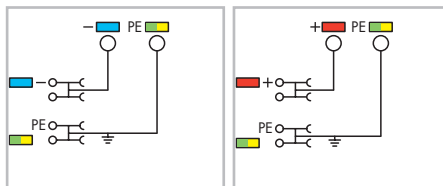

Item No.	Pack. Unit	Item No.	Pack. Unit
<b>3-conductor actuator supply terminal block, max. 250 V, for PNP (high-side) switching actuators, with ground connection, internal bridge</b>		<b>3-conductor actuator supply terminal block, max. 250 V, control panel side: 2.5 (4) mm<sup>2</sup>, max. 28 A, for PNP (high-side) switching actuators, with ground connection</b>	
orange	2000-5377/102-000 15	orange	2000-5357/102-000 15
<b>3-conductor actuator supply terminal block, max. 250 V, for NPN (low-side) switching actuators, with ground connection</b>		<b>3-conductor actuator supply terminal block, 24 VDC, control panel side: 2.5 (4) mm<sup>2</sup>, max. 28 A, for NPN (low-side) switching actuators, with ground connection</b>	
orange	2000-5377/101-000 15	orange	2000-5357/101-000 15

## PUSH-IN CAGE CLAMP®

**Note:**  
The double pin spacing of this terminal block series maximizes connectivity. For example ten sensors may be connected using only five sensor terminal blocks plus power supply terminal block.

- ① Conductor sizes: 0.14 mm<sup>2</sup> ... 1.5 mm<sup>2</sup> "s + f.st"; Push-in conductor sizes: 0.5 mm<sup>2</sup> ... 1.5 mm<sup>2</sup> "s" and 0.5 mm<sup>2</sup> ... 0.75 mm<sup>2</sup> "insulated ferrule, 10 mm"
- ② 250 V = rated voltage  
4 kV = rated surge voltage  
3 = pollution degree  
(see Full Line Catalog, Volume 1, Section 14)
- ③ 3.5 mm pin spacing per signal (2 x 3.5 mm = 7 mm)
- ④ Strip length, see packaging or instructions.
- ⑤ See application notes in Full Line Catalog, Volume 1, for:  
Colored push-in type jumper bars, page 101  
Push-in type wire jumper, page 102
- ⑥ Ground connection via commoning to terminal blocks with ground foot

### Accessories for 4-Conductor Terminal Blocks WMB/Marking strips (see Full Line Catalog, Volume 1, Section 13)

<b>End and intermediate plate, 1 mm thick,</b>	
for 3-conductor terminal blocks	
gray	2000-5391 100 (4x25)

<b>Push-in type jumper bar, insulated,</b>	
⑤ I <sub>N</sub> 14 A, light gray	
2-way	2000-402 200 (8x25)
3-way	2000-403 200 (8x25)
4-way	2000-404 200 (8x25)
5-way	2000-405 100 (4x25)
6-way	2000-406 100 (4x25)
7-way	2000-407 100 (4x25)
8-way	2000-408 100 (4x25)
9-way	2000-409 100 (4x25)
10-way	2000-410 100 (4x25)

<b>Colored push-in type jumper bars,</b>	
red	.../000-005
blue	.../000-006
yellow-green	.../000-018

<b>Push-in type jumper bar, insulated,</b>	
I <sub>N</sub> 14 A, light gray	
from 1 to 3	2000-433 200 (8x25)
from 1 to 4	2000-434 200 (8x25)
from 1 to 5	2000-435 100 (4x25)
from 1 to 6	2000-436 100 (4x25)
from 1 to 7	2000-437 100 (4x25)
from 1 to 8	2000-438 100 (4x25)
from 1 to 9	2000-439 100 (4x25)
from 1 to 10	2000-440 100 (4x25)

<b>Double-deck marker carrier,</b>	
pivoting	
gray	2000-121 50 (2x25)

<b>Marking strip, plain,</b>	
11 mm wide,	
50 m roll	
white	2009-110 1

<b>WMB Multi marking system,</b>	
10 strips with 10 markers per card,	
for 3.5 mm terminal block width	
plain	793-3501 5

<b>Operating tool with a partially insulated shaft,</b>	
type 1, (2.5 x 0.4) mm blade	
	210-719 1

## **X-ON Electronics**

Largest Supplier of Electrical and Electronic Components

*Click to view similar products for [Wago manufacturer](#):*

Other Similar products are found below :

[733-204](#) [734-236](#) [750-460](#) [231-118/026-000](#) [231-303/026-000](#) [231-620/019-000](#) [257-403](#) [280-438](#) [280-831](#) [284-624](#) [206-861](#) [210-111](#) [231-303/037-000](#) [231-446/001-000\\_NR](#) [231-833/001-000](#) [232-216/026-000](#) [234-510](#) [264-726](#) [280-339](#) [890-310](#) [830-800/000-305](#) [788-507](#) [750-512](#) [750-466](#) [236-747](#) [284-413](#) [286-312](#) [713-1428/107-000](#) [731-138/048-000](#) [750-343](#) [750-459](#) [750-517](#) [793-3505](#) [826-172](#) [231-535/001-000](#) [2604-1106](#) [2624-1103](#) [713-1407](#) [713-126](#) [221-525](#) [2106-1201](#) [2106-1301](#) [832-3604](#) [709-581](#) [281-512/281-501](#) [286-336](#) [750-421](#) [750-838](#) [753-559](#) [750-1505](#)