

Supplementary Catalogue 4

to Full Line Catalog W4

Volume 1 and Volume 2

NEU
NEW
NOUVEAU
NUOVO
新製品
NOVO
НОВЫЙ



• Rail-Mounted Terminal Block Systems

• PCB Terminal Blocks and Connectors

NOWOŚĆ
NYHET
NUEVO
UUTUUS
신제품
-नया
NIEUW
NY

WAGO[®]
INNOVATIVE CONNECTIONS

Contents

Volume 1

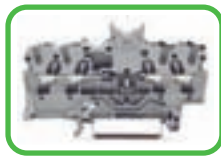

**TOPJOB[®] double potential terminal blocks
with CAGE CLAMP[®]S connection**
1.5 mm²/AWG 22 – 14
2.5 mm²/AWG 22 – 12

Series 2001 02
Series 2002 02



**TOPJOB[®] 3- and 4-conductor terminal blocks
with CAGE CLAMP[®]S connection**
2.5 mm²/AWG 22 – 12

Series 2002 03



**TOPJOB[®] connectors
with CAGE CLAMP[®]S connection**
1.5 mm² – 4 mm²/AWG 14 – 10

Series 20xx 04 – 05

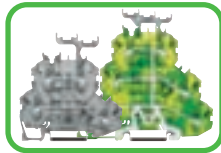

**TOPJOB[®] double and triple deck terminal blocks
with CAGE CLAMP[®]S connection**
2.5 mm²/AWG 22 – 12

Series 2002 06 – 07

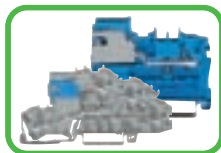

TOPJOB[®] multilevel installation term. blocks w. CAGE CLAMP[®]S connection
4 mm²/AWG 22 – 12 Series 2003 10
6 mm²/AWG 20 – 10 Series 2005 11

**TOPJOB[®] N-disconnect terminal blocks and power distribution disconnect
terminal blocks with CAGE CLAMP[®]S connection**
2.5 mm² – 25 mm²/AWG 22 – 4 Series 20xx 12

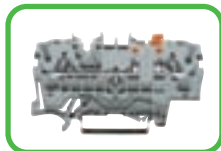

TOPJOB[®] disconnect terminal blocks Series 2002 16 – 18



**TOPJOB[®] diode terminal blocks
and double deck terminal blocks
and triple deck terminal blocks**

Series 2002 19 – 21
Series 2002 22 – 25



TOPJOB[®] accessoires

TOPJOB[®] group marker carriers

Series 2009 26 – 27
27

Marking of TOPJOB[®] rail-mounted terminal blocks

Series 2009 28



**Rail-mounted high current terminal blocks
with POWER CAGE CLAMP[®] connection**
35 mm²/AWG 8 – 2
50 mm²/AWG 8 – 2/0

Series 285 30 – 31
Series 285 32

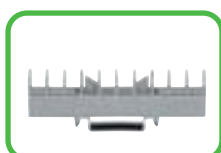

**Collective carrier for jumpers
(suitable for longitudinal disconnect and
transverse switch terminal blocks)**

Series 282 33



X-COM®-SYSTEM

2-cond./1-pin receptacle terminal blocks

0.08 mm² – 4 mm²/AWG 28 – 12

Series 769

34 – 35

1-cond./1-cond. disconnect receptacle terminal blocks

0.08 mm² – 4 mm²/AWG 28 – 12

Series 769

36

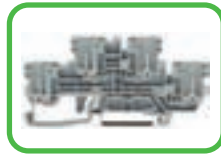

X-COM®-SYSTEM

2-conductor/

2-pin double deck receptacle terminal

Series 870

37

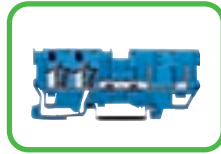

X-COM®-SYSTEM

Blue components

Series 769

38 – 39



X-COM®-SYSTEM

Female plugs for self-assembly

Series 769

40 – 41

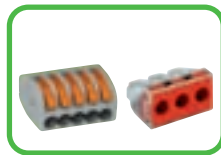

Compact connector for flexible conductors

2 x 0.08 mm² – 2.5 mm²/AWG 28 – 12 and

5 x 0.08 mm² – 2.5 mm²/AWG 28 – 12

Series 222

42

Push-wire connectors for junction boxes

4 x 0.75 mm² – 2.5 mm²/AWG 18 – 12 and

3 x 2.5 mm² – 6 mm²/AWG 14 – 10

Series 773

43



**Shield (screen) clamps,
Carrier with grounding foot,
Busbar carriers**

Series 791

44

Series 790

44

Series 790

45



Shield termination

Series 709

45



Wire and cable marking

Series 211

46 – 49



Marker carriers

for WCB combi marking system

Series 2009

50

Double Potential Terminal Blocks 1.5 (2.5) mm²/AWG 16 Series 2001

2.5 (4) mm²/AWG 12 Series 2002

0.25 – 1.5 (2.5) mm² ① | AWG 22 – 14
 800 V/8 kV/3
 I_N 18 A (24 A)
 Terminal block width 4.2 mm / 0.165 in
 9 – 11 mm / 0.39 in

0.25 – 2.5 (4) mm² ② | AWG 22 – 12
 800 V/8 kV/3
 I_N 24 A (32 A)
 Terminal block width 5.2 mm / 0.205 in
 10 – 12 mm / 0.43 in

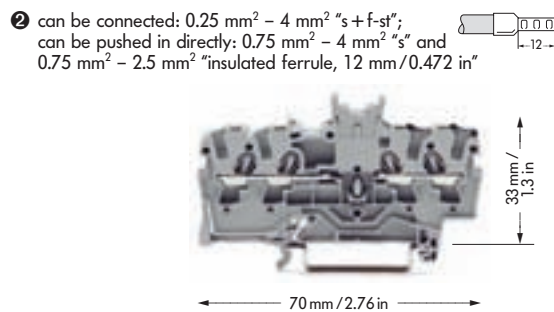
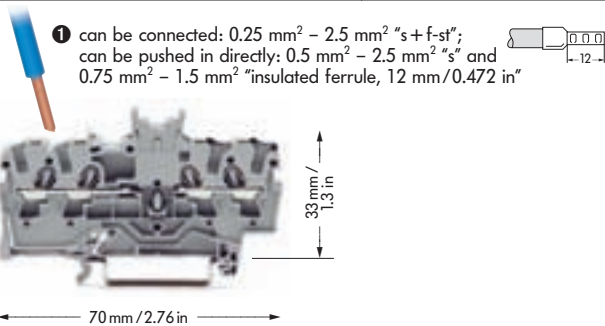

Item No.	Pack.-unit pcs		Item No.	Pack.-unit pcs	
Double potential terminal block, grey	2001-1441 ●	100	Double potential terminal block, grey	2002-1441 ●	100
Attention! This double potential terminal block cannot be commoned with push-in type jumper bars!			Attention! This double potential terminal block cannot be commoned with push-in type jumper bars!		
Accessoires appropriate marking system WMB/Marker strips (see Full Line Catalog W4 Volume 1, Section 14)					
End and intermediate plate, 0.8 mm / 0.331 in thick	orange 2002-1492 100 (4 x 25)		End and intermediate plate, 0.8 mm / 0.331 in thick	orange 2002-1492 100 (4 x 25)	
	grey 2002-1491 100 (4 x 25)			grey 2002-1491 100 (4 x 25)	
Insulation stop , 5 pcs/strip	200 strips		Insulation stop , 5 pcs/strip	200 strips	
	light grey 2001-171 0.25-0.5 mm ²			light grey 2001-171 0.25-0.5 mm ² dark grey 2002-172 0.75-1 mm ²	
			Protective warning marker, for 5 terminal block	yellow 2002-115 100 (4 x 25)	
Double potential terminal blocks are space savers. Two independent through terminal blocks are placed in one insulated housing on one level. The width of the housing is only 4.2 mm/0.165 in. Compared to standard through terminal blocks, the width is only 2.1 mm/0.083 in. Input and output contacts of one circuit are placed on the same side of the terminal block. Both circuits can be individually marked according to input and output.			Double potential terminal blocks are space savers. Two independent through terminal blocks are placed in one insulated housing on one level. The width of the housing is only 5.2 mm/0.205 in. Compared to standard through terminal blocks, the width is only 2.6 mm/0.103 in. Input and output contacts of one circuit are placed on the same side of the terminal block. Both circuits can be individually marked according to input and output.		

TOPJOB® S











3- and 4-Conductor Rail-Mounted Terminal Blocks

2.5 (4) mm²/AWG 12, Series 2002

CAGE CLAMP® S

1

VOLUME 1

0.25 – 2.5 (4) mm² ① 800 V/8 kV/3 I _N 24 A Terminal block width 5.2 mm / 0.205 in  10 – 12 mm / 0.43 in *  	AWG 22 – 12 600 V, 20 A  600 V, 20 A 	0.25 – 2.5 (4) mm² ① 800 V/8 kV/3 I _N 24 A Terminal block width 5.2 mm / 0.205 in  10 – 12 mm / 0.43 in *  	AWG 22 – 12 600 V, 20 A  600 V, 20 A 
--	--	--	--

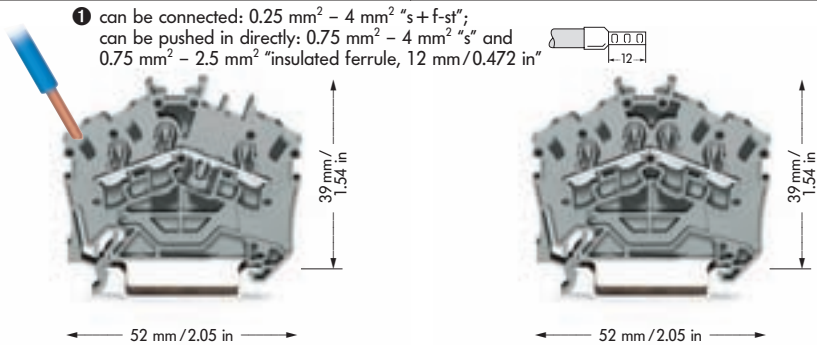

Item No.	Pack.-unit pcs	Item No.	Pack.-unit pcs
3-conductor through terminal blocks		4-conductor through terminal blocks	
grey 2002-6301 	100	grey 2002-6401 	100
blue 2002-6304 	100	blue 2002-6404 	100
orange 2002-6302 	100	orange 2002-6402 	100
more colors are being prepared		more colors are being prepared	
3-conductor ground (earth) terminal block		4-conductor ground (earth) terminal block	
green-yellow 2002-6307 	100	green-yellow 2002-6407 	100
 approvals in preparation		 approvals in preparation	
 Suitable for Ex i applications		 Suitable for Ex i applications	
Attention!			
These terminal blocks cannot be commoned!			
Accessories appropriate marker system (see Full Line Catalog W4 Vol. 1, Sec. 14)		WMB/Marker strips/WMB Inline	
End and intermediate plate , 0.8 mm / 0.031 in thick		End and intermediate plate , 0.8 mm / 0.031 in thick	
orange 2002-6392 100 (4 x 25)	grey 2002-6391 100 (4 x 25)	orange 2002-6392 100 (4 x 25)	grey 2002-6391 100 (4 x 25)
Insulation stop , 5 pcs/strip 200 strips		Insulation stop , 5 pcs/strip 200 strips	
light grey 2002-171 0.25-0.5 mm ²	dark grey 2002-172 0.75-1 mm ²	light grey 2002-171 0.25-0.5 mm ²	dark grey 2002-172 0.75-1 mm ²
Push-in type jumper bars , light grey, insulated, I _N 25 A			
2-way 2002-402 200 (8 x 25)			
3-way 2002-403 200 (8 x 25)			
4-way 2002-404 200 (8 x 25)			
5-way 2002-405 100 (4 x 25)			
:	:		
10-way 2002-410 100 (4 x 25)			
Push-in type jumper bars , light grey, insulated, I _N 25 A			
1 - 3 2002-433 200 (8 x 25)			
1 - 4 2002-434 200 (8 x 25)			
1 - 5 2002-435 100 (4 x 25)			
:	:		
1 - 10 2002-440 100 (4 x 25)			
Protective warning marker , for 5 terminal blocks		Protective warning marker , for 5 terminal blocks	
yellow 2002-115 100 (4 x 25)		yellow 2002-115 100 (4 x 25)	
Modular TOPJOB® S connector , for jumper contact slot			
1 pole 2002-511 100 (4 x 25)			
Spacer , modular 2002-549 100 (4 x 25)			
Test plug adapter , for test plug 4 mm/0.157 in Ø 2009-174 100 (4 x 25)			
Testing tap , for max. 2.5 mm ² 2009-182 100 (4 x 25)			

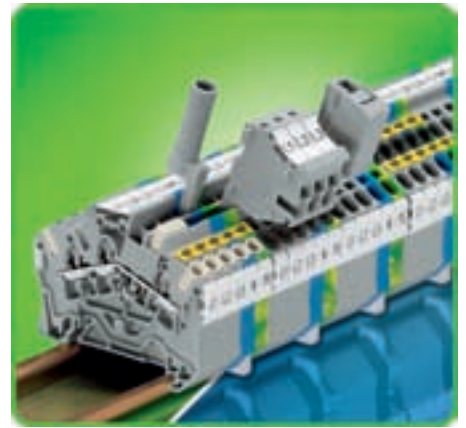

3- and 4-conductor terminal blocks

The new TOPJOB® S rail-mounted terminal blocks have a conductor entry angle of 35 degrees allowing for a very small bend radius and an extremely short wiring distance to the cable duct. For applications in switchgear and control cabinets using the LSC wiring system from Lütze, for example, the new terminal blocks offer a space and cost saving solution. This way, conductors can be placed very close to the terminal blocks and their height can be kept relatively low.

Product characteristics

- CAGE CLAMP® S connection for all types of conductors, with the additional benefit that stripped solid wires and fine-stranded ferruled wires can be simply pushed in
- Vibration-proof, fast, maintenance-free connection
- 3-conductor through and ground (earth) conductor terminal blocks equipped with dual jumper slot
- 4-conductor terminal blocks allow for the multiplication of potentials without using any jumpers and any additional terminal blocks
- 3- and 4-conductor terminal blocks have the same dimensions

*Further approvals with corresponding ratings can be found at www.wago.com



TOPJOB® S Modular Connectors Series 2001/2002/2004

0.25 – 1.5 (2.5) mm² ① | AWG 22 – 14
500 V/6 kV/3 | 300 V, 15 A ②
I_N 18 A | 300 V, 15 A ③
Terminal block width 4.2 mm / 0.165 in
9 – 11 mm / 0.39 in

* ② ③

0.25 – 2.5 (4) mm² ② | AWG 22 – 12
500 V/6 kV/3 | 300 V, 20 A ②
I_N 24 A | 300 V, 20 A ③
Terminal block width 5.2 mm / 0.205 in
10 – 12 mm / 0.43 in

* ② ③

0.5 – 4 (6) mm² ③ | AWG 20 – 10
500 V/6 kV/3 | 300 V, 30 A ②
I_N 32 A | 300 V, 30 A ③
Terminal block width 6.2 mm / 0.244 in
11 – 13 mm / 0.47 in

* ② ③



Item No.	Pack.-unit pcs	Item No.	Pack.-unit pcs	Item No.	Pack.-unit pcs
Modular TOPJOB®S connectors with CAGE CLAMP®S connection, modular, grey, 1 pole		Modular TOPJOB®S connectors with CAGE CLAMP®S connection, modular, grey, 1 pole		Modular TOPJOB®S connectors with CAGE CLAMP®S connection, modular, grey, 1 pole	
2001-511	100 (4 x 25)	2002-511	100 (4 x 25)	2004-511	100 (4 x 25)
Spacer, for bridging over commoned terminal blocks, for example, modular, grey		Spacer, for bridging over commoned terminal blocks, for example, modular, grey		Spacer, for bridging over commoned terminal blocks, for example, modular, grey	
2001-549	100 (4 x 25)	2002-549	100 (4 x 25)	2004-549	100 (4 x 25)
① can be connected: 0.25 mm ² – 2.5 mm ² "s + f-st"; can be pushed in directly: 0.5 mm ² – 2.5 mm ² "s" and 0.75 mm ² – 1.5 mm ² "insulated ferrule, 12 mm/0.472 in"		② can be connected: 0.25 mm ² – 4 mm ² "s + f-st"; can be pushed in directly: 0.75 mm ² – 4 mm ² "s" and 0.75 mm ² – 2.5 mm ² "insulated ferrules, 12 mm/0.472 in"		③ can be connected: 0.5 mm ² – 6 mm ² "s + f-st"; can be pushed in directly: 1 mm ² – 6 mm ² "s" and 0.75 mm ² – 4 mm ² "insulated ferrule, 12 mm/0.472 in"	
Item-specific accessories		Item-specific accessories		Item-specific accessories	
End plate, 1.5 mm/0.059 in thick		End plate, 1.5 mm/0.059 in thick		End plate, 1.5 mm/0.059 in thick	
grey	2002-541 100 (4 x 25)	grey	2002-541 100 (4 x 25)	grey	2002-541 100 (4 x 25)
WMB Multi marking card, 10 strips with 10 markers each, white with black printing, 4 – 4.2 mm/0.157 - 0.165 in wide		WMB Multi marking card, 10 strips with 10 markers each, white with black printing, 5 – 5.2 mm/0.197 - 0.205 in wide		WMB Multi marking card, 10 strips with 10 markers each, white with black printing, 5 – 5.2 mm/0.197 - 0.205 in wide	
793-4 . . .	5 cards	793-5 . . .	5 cards	793-5 . . .	5 cards
794-4 . . .	5 cards	794-5 . . .	5 cards	794-5 . . .	5 cards
see Full Line Catalog W4 Volume 1, Section 14		see Full Line Catalog W4 Volume 1, Section 14		see Full Line Catalog W4 Volume 1, Section 14	



Snapping together of connectors and spacers to assemble a multi-pole connector



Wire connection: Screwdriver actuation for connection of all conductor types, i.e. stripped stranded conductors, or push-in connection of solid or ferruled stranded conductors.





Snapping on a strain relief plate

Accessories for TOPJOB®S connectors		appropriate marker system WMB/Marker strips (see Full Line Catalog W4 Volume 1, Section 14)	
Test plug, with cable 500 mm/177"	Strain relief plate, grey	Marker strips, with, plain, on roll	
2.3 mm/0.091 in Ø yellow 210-137 50 (5 x 10)	snappable onto connector strips	11 mm/0.039 in wide 50 m 2009-110 1	
Test plug, with cable 500 mm/177"	6 mm/0.236 in wide 734-327 100 (4 x 25)	Marker strips, with, plain, on roll	
2 mm/0.079 in Ø red 210-136 50 (5 x 10)	12.5 mm/0.492 in wide 734-328 100 (4 x 25)	11 mm/0.039 in wide 300 m 2009-130 1	
	25 mm/0.984 in wide 734-329 100 (4 x 25)		
	35 mm/1.378 in wide 734-326 100 (4 x 25)		

*Further approvals with corresponding ratings can be found at www.wago.com

TOPJOB® S
Connector Strips
Series 2001/2002/2004

CAGE CLAMP® S

0.25 – 1.5 (2.5) mm² ⓐ 500 V/6 kV/3 I _N 18 A Terminal block width 4.2 mm / 0.165 in  9 – 11 mm / 0.39 in	0.25 – 2.5 (4) mm² ⓑ 500 V/6 kV/3 I _N 24 A Terminal block width 5.2 mm / 0.205 in  10 – 12 mm / 0.43 in	0.5 – 4 (6) mm² ⓒ 500 V/6 kV/3 I _N 32 A Terminal block width 6.2 mm / 0.244 in  11 – 13 mm / 0.47 in
--	---	--



Item No.	Pack.-unit pcs	Item No.	Pack.-unit pcs	Item No.	Pack.-unit pcs
Modular TOPJOB® S connector strips with CAGE CLAMP® S connection, modular, grey,		Modular TOPJOB® S connector strips with CAGE CLAMP® S connection, modular, grey,		Modular TOPJOB® S connector strips with CAGE CLAMP® S connection, modular, grey,	
2-pole	2001-552	2-pole	2002-552	2-pole	2004-552
3-pole	2001-553	3-pole	2002-553	3-pole	2004-553
4-pole	2001-554	4-pole	2002-554	4-pole	2004-554
5-pole	2001-555	5-pole	2002-555	5-pole	2004-555
6-pole	2001-556	6-pole	2002-556		
7-pole	2001-557	7-pole	2002-557		
8-pole	2001-558	8-pole	2002-558		
9-pole	2001-559	9-pole	2002-559		
10-pole	2001-560	10-pole	2002-560		
ⓐ can be connected: 0.25 mm ² – 2.5 mm ² "s + f-st"; can be pushed in directly: 0.5 mm ² – 2.5 mm ² "s" and 0.75 mm ² – 1.5 mm ² "insulated ferrule, 12 mm/0.472 in"		ⓑ can be connected: 0.25 mm ² – 4 mm ² "s + f-st"; can be pushed in directly: 0.75 mm ² – 4 mm ² "s" and 0.75 mm ² – 2.5 mm ² "insulated ferrules, 12 mm/0.472 in"		ⓒ can be connected: 0.5 mm ² – 6 mm ² "s + f-st"; can be pushed in directly: 1 mm ² – 6 mm ² "s" and 0.75 mm ² – 4 mm ² "insulated ferrule, 12 mm/0.472 in"	
Item-specific accessories		Item-specific accessories		Item-specific accessories	
WMB Multi marking card , 10 strips with 10 markers each, white with black printing, 4 – 4.2 mm/0.157 - 0.165 in wide 793-4 . . . 5 cards 794-4 . . . 5 cards see Full Line Catalog W4 Volume 1, Section 14		WMB Multi marking card , 10 strips with 10 markers each, white with black printing, 5 – 5.2 mm/0.197 - 0.205 in wide 793-5 . . . 5 cards 794-5 . . . 5 cards see Full Line Catalog W4 Volume 1, Section 14		WMB Multi marking card , 10 strips with 10 markers each, white with black printing, 5 – 5.2 mm/0.197 - 0.205 in wide 793-5 . . . 5 cards 794-5 . . . 5 cards see Full Line Catalog W4 Volume 1, Section 14	

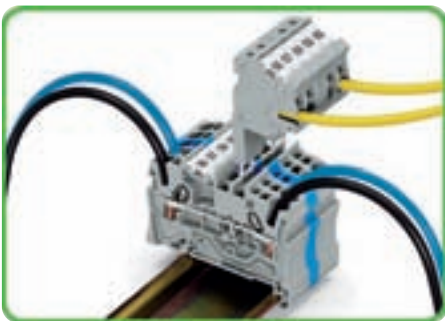

The modular connectors provide an additional connection option for conductors of the same cross section range as the terminal blocks being used.

Miniature WSB Quick marking card , 10 strips with 10 markers each, white with black printing, 5 mm /0.197 in wide 248- . . . 5 cards 249- . . . 5 cards see Full Line Catalog W4 volume 1, section 14	
--	--

WMB Inline , pitch 5 mm/0.197 in, stretchable 5 mm – 5.2 mm/0.197 in – 0.205 in, on roll, 1,500 markers with 2009-115 1	
---	--

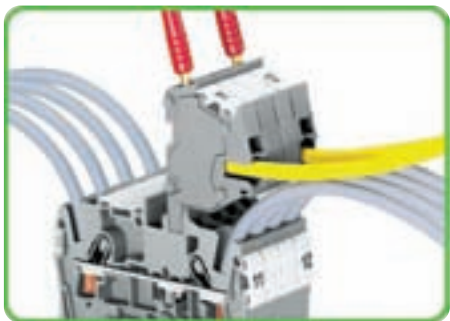

The connector has a test socket for 2 mm/0.079 in or 2.3 mm/0.091 in test plugs.

Accessories for TOPJOB® S connectors appropriate marker system WMB/Marker strips (see Full Line Catalog W4 Volume 1, Section 14)		
Test plug , with cable 500 mm/17.7" 2.3 mm/0.091 in Ø yellow 210-137 50 (5 x 10)	Strain relief plate , grey snappable onto connector strips 	Marker strips , with, plain, on roll 11 mm/0.039 in wide 50 m 2009-110 1
Test plug , with cable 500 mm/17.7" 2 mm/0.079 in Ø red 210-136 50 (5 x 10)	6 mm/0.236 in wide 734-327 100 (4 x 25) 12.5 mm/0.492 in wide 734-328 100 (4 x 25) 25 mm/0.984 in wide 734-329 100 (4 x 25) 35 mm/1.378 in wide 734-326 100 (4 x 25)	Marker strips , with, plain, on roll 11 mm/0.039 in wide 300 m 2009-130 1

TOPJOB® Double Deck Terminal Blocks 2.5 (4) mm² / AWG 12 Series 2002

0.25 – 2.5 (4) mm² ① | AWG 22 – 12
500 V/6 kV/3 | 600 V, 20 A ②
I_N 24 A | 600 V, 20 A ③
Terminal block width 5.2 mm / 0.205 in
10 – 12 mm / 0.43 in

0.25 – 2.5 (4) mm² ① | AWG 22 – 12
500 V/6 kV/3 | 600 V, 20 A ②
I_N 24 A | 600 V, 20 A ③
Terminal block width 5.2 mm / 0.205 in
10 – 12 mm / 0.43 in

* ② ③

* ② ③

① can be connected: 0.25 mm² – 4 mm² "s + f-st";
can be pushed in directly: 0.75 mm² – 4 mm² "s" and
0.75 mm² – 2.5 mm² "insulated ferrule, 12 mm/0.472 in"

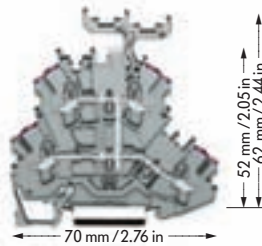
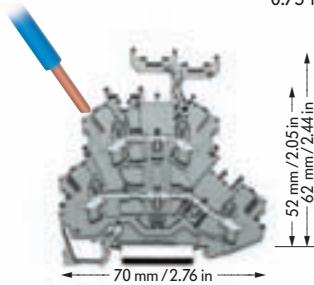
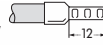

Item No.	Item No.	Pack.-unit pcs	Item No.	Item No.	Pack.-unit pcs
Double deck terminal blocks, for DIN 35 rail			Double deck terminal blocks, for DIN 35 rail		
Through-/through terminal blocks,			4-conductor through terminal block, internal commoning,		
housing color grey			housing color grey, conductor entry position colored in violet		
Marking carrier with			Marking carrier with		
L/L	2002-2231	2002-2201 50	L	2002-2238	2002-2208 50
N/L	2002-2232	2002-2202 50	4-conductor through terminal block,		
L/N	2002-2233	2002-2203 50	internal commoning, housing color blue,		
Housing color blue			conductor entry position colored in violet		
N/N	2002-2234 ②	2002-2204 ② 50	N	2002-2239 ②	2002-2209 ② 50
ⓧ applications are being prepared			ⓧ applications are being prepared		
② Suitable for Ex i applications			② Suitable for Ex i applications		



① can be connected: 0.25 mm² – 4 mm² "s + f-st";
can be pushed in directly: 0.75 mm² – 4 mm² "s" and
0.75 mm² – 2.5 mm² "insulated ferrule, 12 mm/0.472 in"

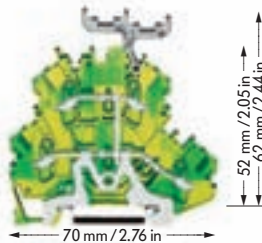
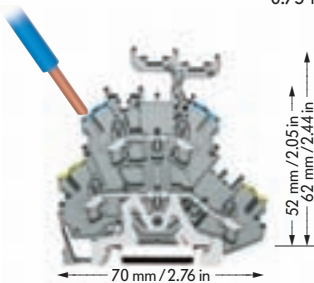
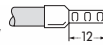

Item No.	Item No.	Pack.-unit pcs	Item No.	Item No.	Pack.-unit pcs	Item No.	Pack.-unit pcs
Double deck terminal blocks, for DIN 35 rail			Double deck terminal blocks, for DIN 35 rail				
Ground (earth) conductor/through terminal block,			4-conductor ground (earth) terminal block,				
			internal commoning				
Housing color grey			Housing color green-yellow				
Marking carrier with			Marking carrier with				
PE/N	2002-2247	2002-2217 50					
PE/L	2002-2257	2002-2227 50	PE	2002-2237	2002-2207 50		
ⓧ applications are being prepared			ⓧ applications are being prepared				

Accessories

appropriate marking system **WMB/marker strips/WMB Inline** (see Full Line Catalog W4 Volume 1, Section 14)

End and intermediate plate, 0.8 mm/0.032 in thick orange 2002-2292 100 (4 x 25) grey 2002-2291 100 (4 x 25)	Two-way marking adapter, pivotable 2002-121 50 (4 x 25)	Protective warning marker, for 5 terminal blocks yellow 2002-115 100 (4 x 25)
Push-in type jumper bars, light grey, insulated, I_N 2-way 2002-402 200 (8 x 25) 3-way 2002-403 200 (8 x 25) 4-way 2002-404 200 (8 x 25) 5-way 2002-405 100 (4 x 25) : : 10-way 2002-410 100 (4 x 25)	Push-in type jumper bars, light grey, insulated, I_N 1 - 3 2002-433 200 (8 x 25) 1 - 4 2002-434 200 (8 x 25) 1 - 5 2002-435 100 (4 x 25) : : 1 - 10 2002-440 100 (4 x 25)	Marker strips, white, plain, for central marking, 11 mm/0.433 in wide, on roll 50 m 2009-110 1 300 m 2009-130 1
		Insulation stop, see page 17 TOPJOB® Catalog

*Further approvals with corresponding ratings can be found at www.wago.com

TOPJOB® S Triple Deck Terminal Blocks 2.5 (4) mm² / AWG 12 Series 2002

CAGE CLAMP® S

VOLUME 1

0.25 – 2.5 (4) mm² ① AWG 22 – 12 500 V/6 kV/3 600 V, 20 A I _N 24 A 600 V, 20 A Terminal block width 5.2 / 0.205 in 10 – 12 mm / 0.43 in *	0.25 – 2.5 (4) mm² ① AWG 22 – 12 500 V/6 kV/3 600 V, 20 A I _N 24 A 600 V, 20 A Terminal block width 5.2 mm / 0.205 in 10 – 12 mm / 0.43 in *	0.25 – 2.5 (4) mm² ① AWG 22 – 12 500 V/6 kV/3 600 V, 20 A I _N 24 A 600 V, 20 A Terminal block width 5.2 mm / 0.205 in 10 – 12 mm / 0.43 in *
---	--	--

① can be connected: 0.25 mm² – 4 mm² "s + f-st";
 can be pushed in directly: 0.75 mm² – 4 mm² "s" and 0.75 mm² "insulated ferrule, 12 mm/0.472 in"

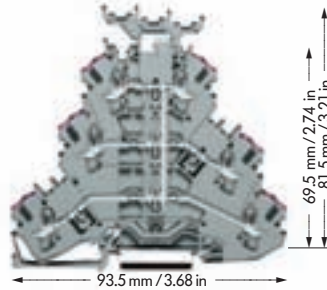
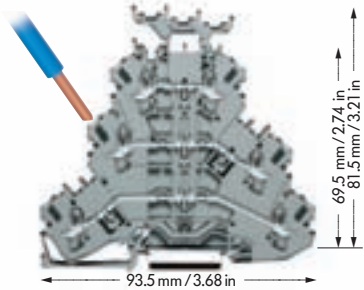

Item No.	Item No.	Pack.-unit pcs	Item No.	Item No.	Pack.-unit pcs
Triple deck terminal blocks, for DIN 35 rail			Triple deck terminal block, for DIN 35 rail		
Through-/through-/through terminal blocks,			6-conductor through terminal block, internal commoning,		
housing color grey			housing color grey, conductor entry position colored in violet		
Marking carrier with			Marking carrier with		
L/L/L	2002-3231	2002-3201 50	L	2002-3238	2002-3208 50
L/L/N	2002-3233	2002-3203 50	6-conductor through terminal block,		
Housing color blue			internal commoning, housing color blue,		
N/N/N	2002-3234	2002-3204	conductor entry position colored in violet		
			N	2002-3239	2002-3209
applications are being prepared			applications are being prepared		
Suitable for Ex i applications			Suitable for Ex i applications		



① can be connected: 0.25 mm² – 4 mm² "s + f-st";
 can be pushed in directly: 0.75 mm² – 4 mm² "s" and 0.75 mm² "insulated ferrule, 12 mm/0.472 in"

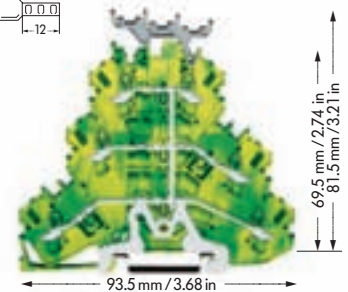
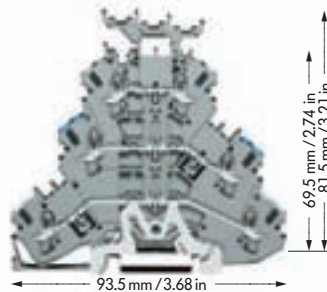
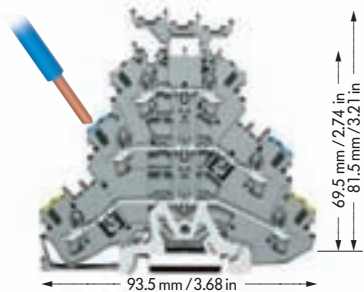

Item No.	Item No.	Pack.-unit pcs	Item No.	Item No.	Pack.-unit pcs	Item No.	Item No.	Pack.-unit pcs
Triple deck terminal blocks, for DIN 35 rail			Triple deck terminal block, for DIN 35 rail			Triple deck terminal block, for DIN 35 rail		
Ground (earth)/through/through terminal blocks,			Shield (screen)/through/through terminal blocks,			6-conductor ground (earth) terminal block,		
housing color grey			housing color grey			internal commoning		
housing color grey			housing color grey			housing color green-yellow		
Marking carrier with			Marking carrier with			Marking carrier with		
PE/N/L	2002-3247	2002-3217 50	Schirm/N/L	2002-3248	2002-3218 50	PE	2002-3237	2002-3207 50
PE/L/L	2002-3257	2002-3227 50	Schirm/L/L	2002-3258	2002-3228 50			
applications are being prepared			applications are being prepared			applications are being prepared		

Accessories

appropriate marking system **WMB/marker strips/WMB Inline** (see Full Line Catalog W4 Volume 1, Section 14))

End and intermediate plate, 0.8 mm/0.032 in thick orange 2002-3292 100 (4 x 25) grey 2002-3291 100 (4 x 25)	Two-way marking adapter, pivotable 2002-131 50 (2 x 25)	Protective warning marker, for 5 terminal blocks yellow 2002-115 100 (4 x 25)
Push-in type jumper bars, light grey, insulated, I_N 2-way 2002-402 200 (8 x 25) 3-way 2002-403 200 (8 x 25) 4-way 2002-404 200 (8 x 25) 5-way 2002-405 100 (4 x 25) : : 10-way 2002-410 100 (4 x 25)	Push-in type jumper bars, light grey, insulated, I_N 1 - 3 2002-433 200 (8 x 25) 1 - 4 2002-434 200 (8 x 25) 1 - 5 2002-435 100 (4 x 25) : : 1 - 10 2002-440 100 (4 x 25)	Marker strips, white, plain, for central marking, 11 mm/0.433 in wide, on roll 50 m 2009-110 1 300 m 2009-130 1
Insulation stop, see page 17 TOPJOB® S Catalog		

TOPJOB® S



Very compact dimensions provide maximum wiring space in standard distribution boxes. The 2003 Series multilevel installation terminal blocks are the smallest terminal blocks with direct insertion wire connection on the market providing the full functionality of a 4 mm²/AWG 12 terminal block.



Push-in type jumper bars with breakable contact lugs offer the same benefits to the TOPJOB® S installation terminal blocks as to the rail-mounted terminal blocks (e.g. individual jumper configuration on site, skipping of potentials, etc.).



Screwless N-disconnect slide link for automatic and safe connection onto the N-busbar by simply sliding the link.



The busbar carrier with end stop function, which is only **7.5 mm / 0.295 in wide** can replace end stop.

The detachable separator plate on the carrier can be used both for separating the different potentials of N-busbars that are directly next to each other or as a touch-proof end plate for an N-busbar.



The compact busbar carrier, which is placed every 200 mm / 7.87 in, is used to additionally support the busbar on a long assembly.

Perforations make it possible to fit the carrier to all TOPJOB® S installation terminal blocks using a single part.

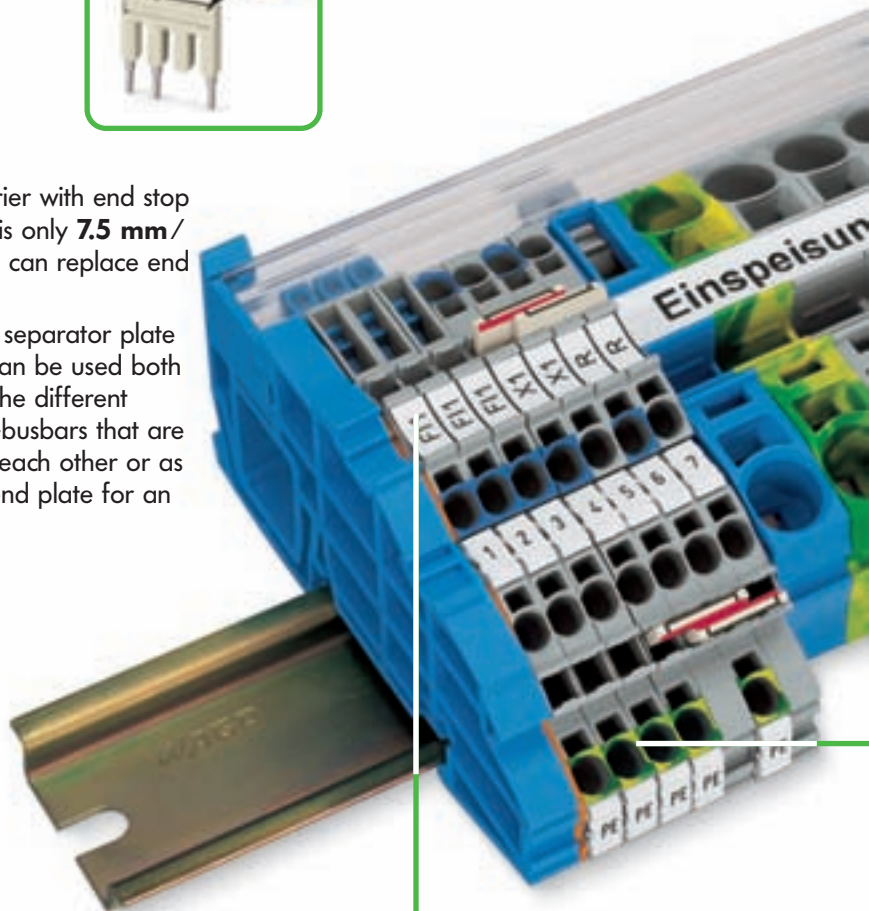

Each connection point has an individual marker receptacle for WMB markers. Additionally, the upper marker receptacle is suitable for marker strips that can be marked manually using a marker pen or automatically by a thermal transfer printer.



Commoning is done using the new staggered jumper system in one single TOPJOB® S jumper slot. The multilevel installation terminal blocks of Series 2003 are therefore suitable for use in very confined spaces.

The optional busbar transparent cover (item no. 777-303) protects the busbar against accidental contact and makes it easy to see which terminal blocks are connected to the busbar.

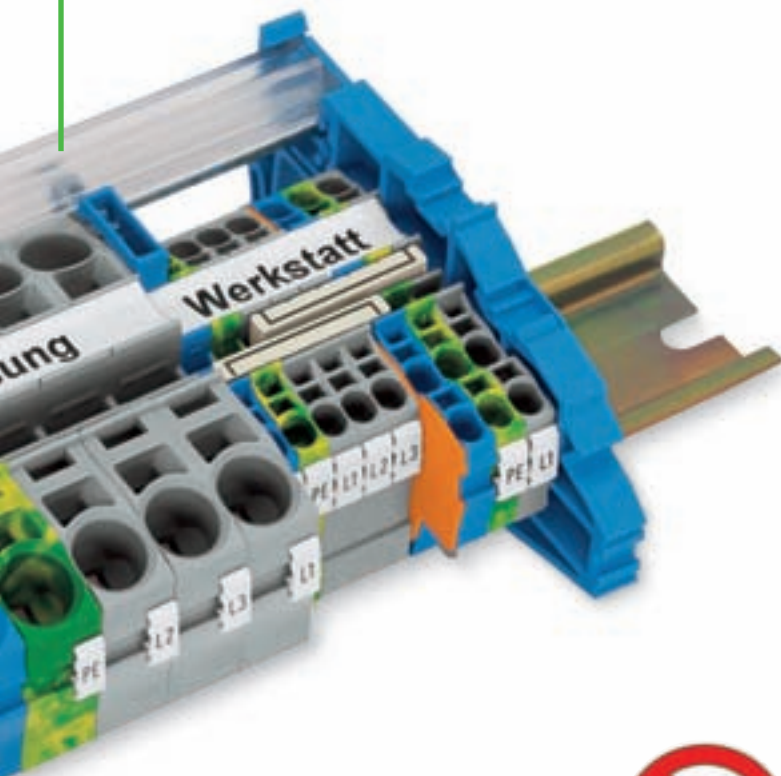

Removal of staggered jumpers

Insert the screwdriver blade between the jumpers and lift them up.



Environmentally friendly:
TOPJOB® S terminal blocks are **100 % lead-free!**



The conductor entry holes of the multilevel installation terminal blocks are color marked, providing a clear arrangement of the terminals.

The grounding foot automatically guarantees a safe connection to the carrier rail.

TOPJOB® S – The range of terminal blocks for all types of applications.

- The direct connection of solid wires in small distribution boxes saves time and money.
- Operating errors can be prevented as all types of terminal blocks for building installation are equipped with push-in connection technology.
- Terminal blocks for building installation expand circuit design possibilities.
- The use of standard accessories reduces order-processing and stock-holding costs.
- A high level of application safety is achieved through optimum knowledge of the small range of parts.
- As the position of the busbars is the same, the new TOPJOB® S installation terminal blocks are compatible with standard topJob installation terminal blocks.



TOPJOB® Multilevel Installation Terminal Blocks 4 mm²/AWG 12 Series 2003

0.25 – 2.5 (4) mm² ① AWG 22 – 12
250 V/4 kV ②/3 400 V/6 kV ③/3
I_N 32 A
Terminal block width 5.2 mm / 0.205 in
10 – 12 mm / 0.43 in

0.25 – 2.5 (4) mm² ① AWG 22 – 12
400 V/6 kV/3
I_N 32 A
Terminal block width 5.2 mm / 0.205 in
10 – 12 mm / 0.43 in

Accessories for
2003 Series multilevel installation
terminal blocks and
2002/2006/2016 Series N-conductor
disconnect terminal blocks

① can be connected: 0.25 mm² – 4 mm² "s + f-st";
can be pushed in directly: 0.75 mm² – 4 mm² "s" and
0.75 mm² – 2.5 mm² "insulated ferrule, 12 mm / 0.472 in"

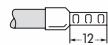

Item No.	Pack.-unit pcs
Multilevel installation terminal block, grey with N-disconnect slide link	
NT/L/PE 2003-7641	50
② Potential-Ground ③ Potential-Potential	

Item No.	Pack.-unit pcs
Multilevel installation terminal blocks, grey	
L/L 2003-7642	50
N/L 2003-7649	50

Item No.	Pack.-unit pcs
End and intermediate plate, 1 mm / 0.039 in thick orange	2003-7692 100 (4 x 25)
Busbar carrier, for DIN rail 35 (not suitable for use as end stop)	
1.5 mm / 0.059 in thick blue	2009-304 100 (4 x 25)
Busbar carrier with end stop function and detachable separator plate, for DIN rail 35; 7.5 mm / 0.295 in thick blue	2009-305 25
N-busbar, tinned	see page 11
Cover for N-busbar, transparent	see page 11
Neutral supply terminal block, I _N 76 A, 16 mm ² /AWG 6, blue	
12 mm / 0.472 in wide	2016-7114 25
Ground (earth) supply terminal block, I _N 76 A, 16 mm ² /AWG 6, green-yellow,	
12 mm / 0.472 in wide	2016-1207 20
TOPJOB® tool, special blades	
3.5 mm / 0.137 in and 5.5 mm / 0.217 in	2009-310 1
Connector, with blue cover	see page 11
Connector, uninsulated,	see page 11
Push-in type jumper bars, light grey, insulated, I _N 25 A	
2-way	2002-402 200 (8 x 25)
3-way	2002-403 200 (8 x 25)
4-way	2002-404 200 (8 x 25)
5-way	2002-405 100 (4 x 25)
:	:
10-way	2002-410 100 (4 x 25)
Push-in type jumper bars, light grey, insulated, I _N 25 A	
1 - 3	2002-433 200 (8 x 25)
1 - 4	2002-434 200 (8 x 25)
1 - 5	2002-435 100 (4 x 25)
:	:
1 - 10	2002-440 100 (4 x 25)
Staggered jumper, light grey, insulated, I _N 25 A	
2-way	2002-472 100 (4 x 25)
3-way	2002-473 100 (4 x 25)
4-way	2002-474 100 (4 x 25)
5-way	2002-475 50 (2 x 25)
:	:
12-way	2002-482 50 (2 x 25)
Pre-assembled staggered jumpers, with contact lugs that are factory removed with circuit printing, I _N 25 A	
1-3	2002-473/0011-0000
1-3-5	2002-475/0011-0000
1-3-5-7	2002-477/0011-0000
1-3-5-7-9	2002-479/0011-0000
1-3-5-7-9-11	2002-481/0011-0000
Test plug, Ø 2 mm / 0.079 in	210-136 50 (5 x 10)
Test plug adapter, for test plug Ø 4 mm / 0.157 in	2009-174 100 (4 x 25)
Testing tap, for max. 2.5 mm ² /AWG 14	2009-182 100 (4 x 25)



Staggered jumper with 7 contacts
Breaking off contact lugs

Item No.	Pack.-unit pcs
Multilevel installation terminal blocks, grey	
N/L/PE 2003-7646	50
L/L/PE 2003-7645	50



Staggered jumper 1 – 3 – 5 – 7
Marking with a felt tip pen

Commoning using staggered jumpers

Individual jumper contacts can be broken off by bending them. The remaining piece of insulation meets the requirements for the air and creepage distance.

This makes it possible to create custom staggered jumpers, e.g. for bridging over a terminal block with a different potential. When creating the jumpers, make sure that only one contact lug is in contact with the terminal block.

That way, staggered jumpers are created whose contact lugs will make contact to the terminal block in the gaps of the second jumper. Insert the jumper into the jumper slot up to the stop.





Two staggered jumpers 1 – 3 – 5 – 7
staggered for use in a jumper slot



Locate red stripes of the staggered jumpers on the inside

N-Disconnect Terminal Blocks and Power Distribution Disconnect Terminal Blocks Series 2002, 2006 and 2016

0.25 – 2.5 (4) mm² ① | AWG 22 – 12
 250 V/4 kV/3
 I_N 32 A
 Terminal block width 5.2 mm / 0.205 in
 10 – 12 mm / 0.43 in

0.5 – 6 (10) mm² ① | AWG 20 – 8
 250 V/4 kV/3
 I_N 51 A
 Terminal block width 7.5 mm / 0.295 in
 13 – 15 mm / 0.55 in

0.5 – 16 (25 "f") mm² ① | AWG 20 – 4
 250 V/4 kV/3
 I_N 76 A
 Terminal block width 12 mm / 0.472 in
 18 – 20 mm / 0.75 in

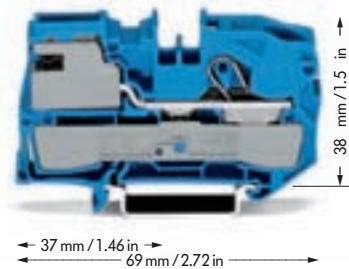
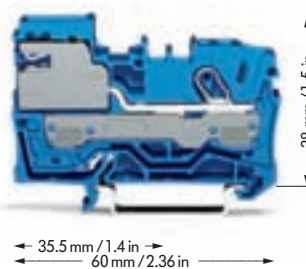
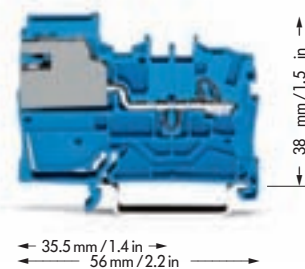

Item No.	Pack.-unit pcs	Item No.	Pack.-unit pcs	Item No.	Pack.-unit pcs
1-conductor N-disconnect terminal block		1-conductor N-disconnect terminal block		1-conductor N-disconnect terminal block	
blue	2002-7114 ②	50	blue	2006-7114 ②	50
1-conductor power distribution disconnect terminal block		1-conductor power distribution disconnect terminal block		1-conductor power distribution disconnect terminal block	
grey	2002-7111 ③	50	grey	2006-7111 ③	50
End and intermediate plate, 0.8 mm / 0.031 in thick		End and intermediate plate, 1 mm / 0.039 in thick		End and intermediate plate, 1 mm / 0.039 in thick	
orange	2002-7192	100 (4 x 25)	orange	2006-7192	100 (4 x 25)
For appropriate through and earth conductor terminal blocks see page 17 in TOPJOB® catalog		For appropriate through and earth conductor terminal blocks see page 17 in TOPJOB® catalog		For appropriate through and earth conductor terminal blocks see page 17 in TOPJOB® catalog	



Testing with test plug Ø 2 mm



Operation of the slide link using a simple screwdriver

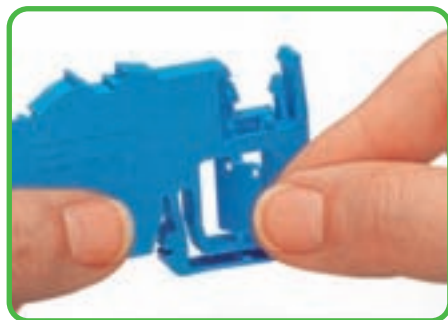

Removing the separator plate from the busbar carrier.



Insertion of the separator plate. To protect the N-busbar against accidental contact

- ① see also appropriate through terminal blocks
- ② For the construction and operation of power installations in fire hazardous locations or public buildings, such as meeting places, stores, hospitals, schools, theaters, hotels etc., the VDE 0100 or VDE 0108-1 standards must be observed. VDE 0100-482 must be observed for fire hazardous locations. Both VDE regulations determine that insulation testing must be possible for every circuit without disconnecting the N-conductor. WAGO N-disconnect terminal blocks meet this requirement.
- ③ According to VDE 0107 "Installing and testing electrical installations in medical locations", the equipotential bonding conductors must be connected to a potential equalization busbar. The potential equalization busbar and the protective earth conductor busbar must be accommodated in a common housing and be connected by means of a disconnectable connection using a copper conductor with a minimum cross section of 16 mm²/AWG 6. Furthermore, all equipotential bonding conductors must be connected to the potential equalization busbar in such a way that they are clearly arranged, that they can be disconnected individually and accessed at any time and, depending on their function, they must be provided with captive marking. The WAGO power distribution disconnect terminal blocks meet these requirements.

TOPJOB® S

Movable knife disconnects clearly indicate the circuit state.

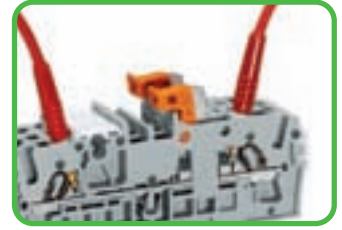

2- and 4-conductor disconnect terminal blocks

The 5.2 mm/0.205 in wide 2- and 4-conductor disconnect terminal blocks, that can be used in both control and process measurement systems as well as transformer circuits, are an addition to the range of TOPJOB® S rail-mounted terminal blocks.

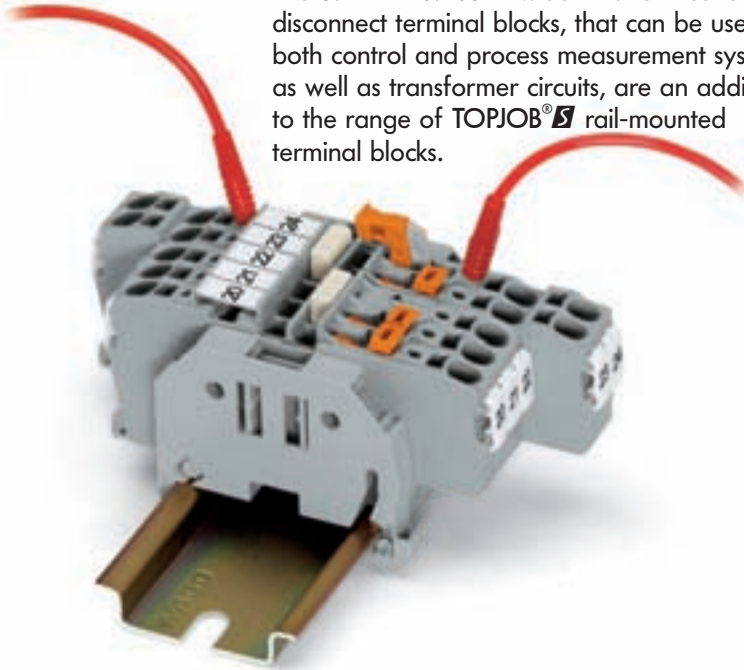

Two lateral and one center marker receptacle for WMB markers or marking strips. Dual jumper slots, in the same position as the other 2002 Series terminal blocks. Commoning options in front of or behind the knife disconnect, depending on which is the power supply side.



Additional marking option using pivoting marking adapters.

Double deck double disconnect terminal blocks

Disconnect terminal blocks of independent potentials are accommodated on two levels in a double deck disconnect terminal block. This results in a space saving arrangement without compromising the clarity of operation. The knife disconnects are located between the conductors and are therefore always in full view of the operator.

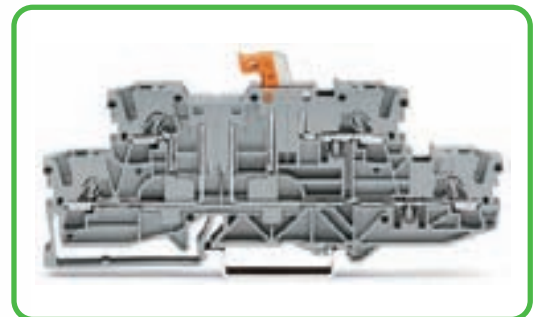
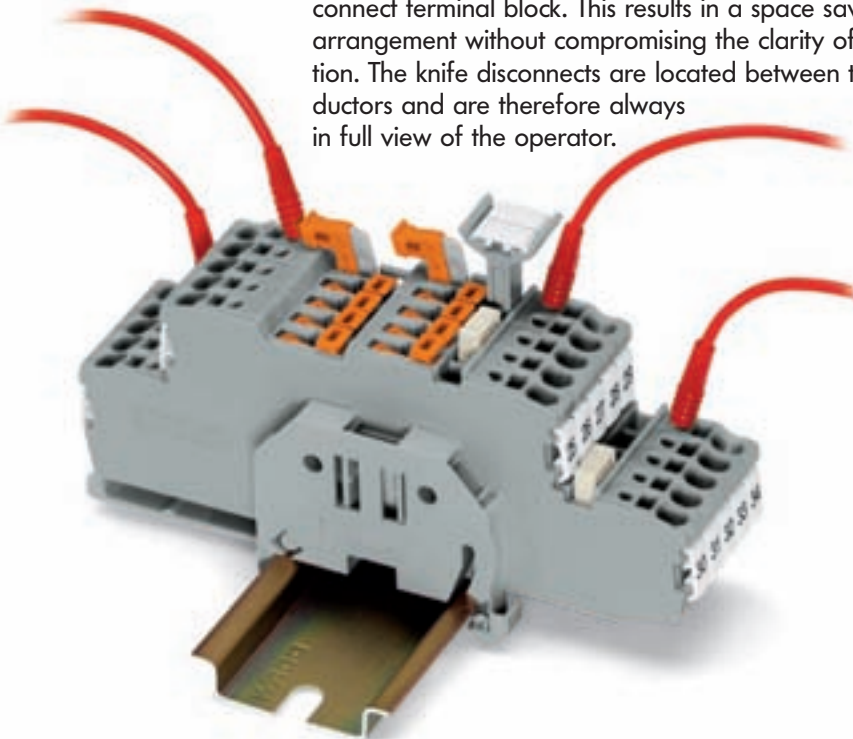

One disconnect and one through terminal block are accommodated on two levels in a terminal block that is only 5.2 mm/0.205 in wide.

Diode terminal blocks



These diode terminal blocks have been specially developed for custom diode circuits such as lamp test and collective fault signal circuits.

Using LED terminal blocks, monitoring units can be designed for control and operating circuits.

The terminal blocks provide high density wiring maintaining a width of only 5.2 mm/0.205 in.

Using push-in type jumper bars opens up additional possibilities when designing custom circuits.

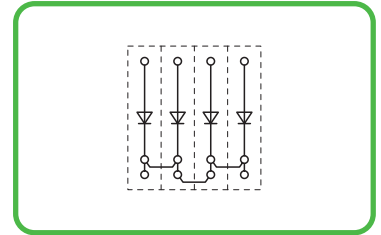

Polarized diode gate, common cathode

Double deck diode terminal blocks

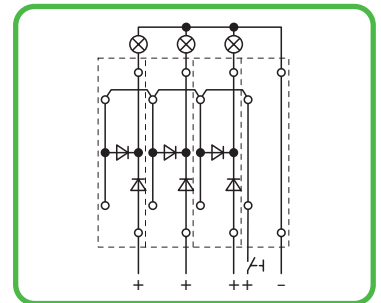
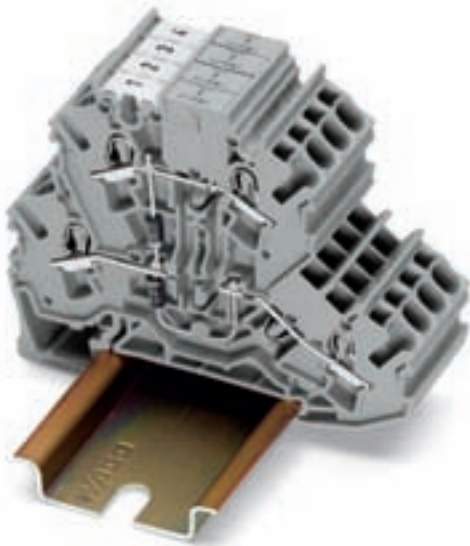

Lamp test circuit

Triple deck diode terminal blocks

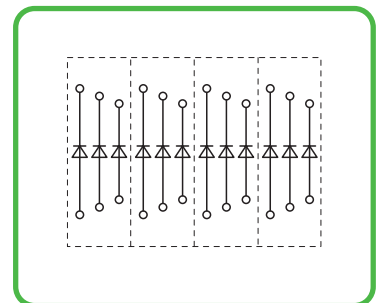
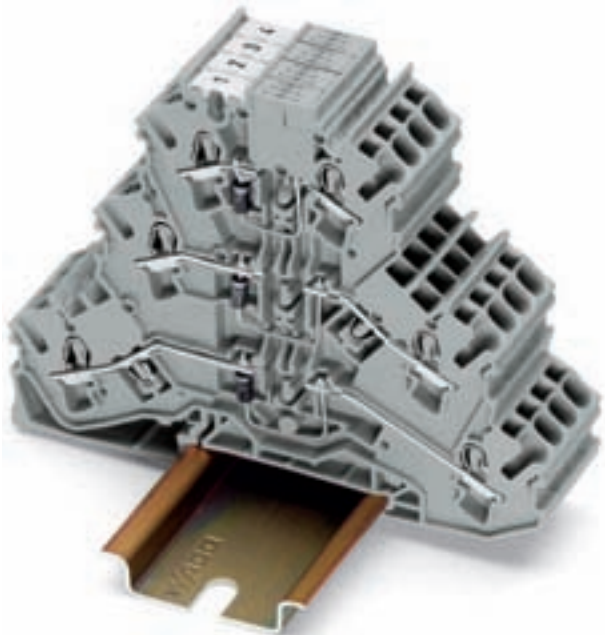

Open diode gate, can be connected individually. Using push-in type jumper bars, individual levels can be turned into polarized diode gates.

Disconnect Terminal Blocks for Test and Measurement with Movable Knife Disconnect and Through Terminal Blocks, Series 2002

0.25 – 2.5 (4) mm² ① | AWG 22 – 12
 400 V/6 kV/3
 I_N 16 A
 Terminal block width 5.2 mm / 0.205 in
 10 – 12 mm / 0.43 in

0.25 – 2.5 (4) mm² ① | AWG 22 – 12
 400 V/6 kV/3
 I_N 16 A
 Terminal block width 5.2 mm / 0.205 in
 10 – 12 mm / 0.43 in

① can be connected: 0.25 mm² – 4 mm² "s" + f-st";
 can be pushed in directly: 0.75 mm² – 4 mm² "s" and
 0.75 mm² – 2.5 mm² "insulated ferrule, 12 mm/0.472 in"

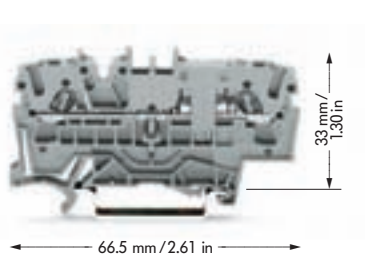
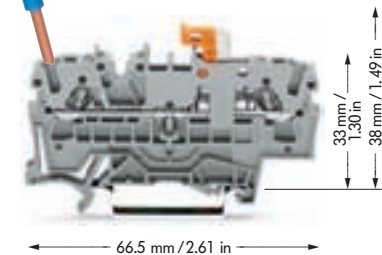
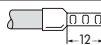

Item No.	Pack.-unit pcs	Item No.	Pack.-unit pcs
2-conductor disconnect terminal block for test and measurement		2-conductor through terminal blocks, same profile as disconnect terminal block	
grey	2002-1671	grey	2002-1601
blue	2002-1674	blue	2002-1604
orange	2002-1672	orange	2002-1602
Item-specific accessories			
End and intermediate plate, 1 mm / 0.039 in thick		End and intermediate plate, 1 mm / 0.039 in thick	
orange	2002-1692 100 (4 x 25)	orange	2002-1692 100 (4 x 25)
grey	2002-1691 100 (4 x 25)	grey	2002-1691 100 (4 x 25)
Accessories Series 2002 appropriate marker system WMB/Marker strips/WMB Inline (see Full Line Catalog W4 Volume 1, Section 14)			
Insulation stop, 5 pcs/strip 200 strips		Protective warning marker,	
light grey	2002-171 0.25-0.5 mm ²	for 5 terminal blocks	
dark grey	2002-172 0.75-1 mm ²	yellow	2002-115 100 (4 x 25)
Push-in type jumper bars, light grey, insulated, I_N 25 A		Staggered jumper, light grey, insulated, I_N 25 A	
2-way	2002-402 200 (8 x 25)	2-way	2002-472 100 (4 x 25)
3-way	2002-403 200 (8 x 25)	3-way	2002-473 100 (4 x 25)
4-way	2002-404 200 (8 x 25)	4-way	2002-474 100 (4 x 25)
5-way	2002-405 100 (4 x 25)	5-way	2002-475 50 (2 x 25)
:	:	:	:
10-way	2002-410 100 (4 x 25)	12-way	2002-482 50 (2 x 25)
Push-in type jumper bars, light grey, insulated, I_N 25 A		Test plug adapter, for test plug Ø 4 mm / 0.157 in	
1 - 3	2002-433 200 (8 x 25)	2009-174	100 (4 x 25)
1 - 4	2002-434 200 (8 x 25)		
1 - 5	2002-435 100 (4 x 25)		
:	:		
1 - 10	2002-440 100 (4 x 25)	Testing tap, for max. 2.5 mm²/AWG 14	
		2009-182	100 (4 x 25)
Modular TOPJOB® connector, for jumper contact slot		Two-way marking adapter, pivotable	
1 pole	2002-511 100 (4 x 25)	2002-121	50 (4 x 25)
Spacer, modular			
	2002-549 100 (4 x 25)		
Test plug, with cable 500 mm / 17.7"			
Ø 2 mm / 0.079 in			
red	210-136 50 (5 x 10)		

<p>0.25 – 2.5 (4) mm² ⓘ AWG 22 – 12 400 V/6 kV/3 I_N 16 A Terminal block width 5.2 mm / 0.205 in 10 – 12 mm / 0.43 in</p>	<p>0.25 – 2.5 (4) mm² ⓘ AWG 22 – 12 400 V/6 kV/3 I_N 16 A Terminal block width 5.2 mm / 0.205 in 10 – 12 mm / 0.43 in</p>
--	--

ⓘ can be connected: 0.25 mm² – 4 mm² "s + f-st";
can be pushed in directly: 0.75 mm² – 4 mm² "s" and
0.75 mm² – 2.5 mm² "insulated ferrule, 12 mm/0.472 in"

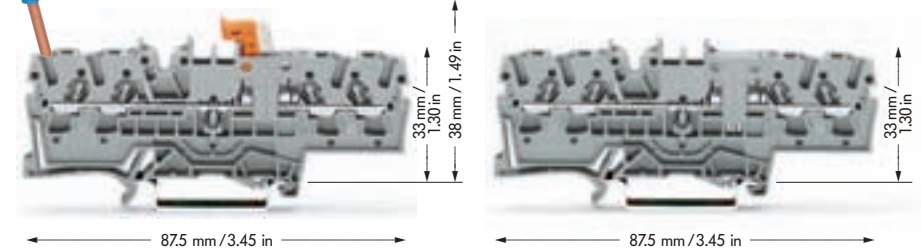

Item No.	Pack.-unit pcs	Item No.	Pack.-unit pcs
4-conductor disconnect terminal block for test and measurement		4-conductor through terminal blocks, same profile as disconnect terminal block	
grey	2002-1871	grey	2002-1801
blue	2002-1874	blue	2002-1804
orange	2002-1872	orange	2002-1802

Item-specific accessories

<p>End and intermediate plate, 1 mm/0.039 in thick orange 2002-1892 100 (4 x 25) grey 2002-1891 100 (4 x 25)</p>	<p>End and intermediate plate, 1 mm/0.039 in thick orange 2002-1892 100 (4 x 25) grey 2002-1891 100 (4 x 25)</p>
---	---

Accessories Series 2002

appropriate marker system **WMB/Marker strips/WMB Inline** (see Full Line Catalog W4 Volume 1, Section 14)

<p>Insulation stop, 5 pcs/strip 200 strips light grey 2002-171 0.25-0.5 mm² dark grey 2002-172 0.75-1 mm²</p>	<p>Protective warning marker, for 5 terminal blocks yellow 2002-115 100 (4 x 25)</p>
<p>Push-in type jumper bars, light grey, insulated, I_N 25 A 2-way 2002-402 200 (8 x 25) 3-way 2002-403 200 (8 x 25) 4-way 2002-404 200 (8 x 25) 5-way 2002-405 100 (4 x 25) : : 10-way 2002-410 100 (4 x 25)</p>	<p>Staggered jumper, light grey, insulated, I_N 25 A 2-way 2002-472 100 (4 x 25) 3-way 2002-473 100 (4 x 25) 4-way 2002-474 100 (4 x 25) 5-way 2002-475 50 (2 x 25) : : 12-way 2002-482 50 (2 x 25)</p>
<p>Push-in type jumper bars, light grey, insulated, I_N 25 A 1 - 3 2002-433 200 (8 x 25) 1 - 4 2002-434 200 (8 x 25) 1 - 5 2002-435 100 (4 x 25) : : 1 - 10 2002-440 100 (4 x 25)</p>	<p>Test plug adapter, for test plug Ø 4 mm/0.157 in 2009-174 100 (4 x 25)</p> <p>Testing tap, for max. 2.5 mm²/AWG 14 2009-182 100 (4 x 25)</p>
<p>Modular TOPJOB® S connector**, for jumper contact slot 1 pole 2002-511 100 (4 x 25)</p>	<p>Two-way marking adapter, pivotable 2002-121 50 (4 x 25)</p>
<p>Spacer, modular 2002-549 100 (4 x 25)</p>	
<p>Test plug, with cable 500 mm/17.7" Ø 2 mm/0.079 in red 210-136 50 (5 x 10)</p>	

TOPJOB® S

Double Deck Double Disconnect Terminal Blocks for Test and Measurement with Movable Knife Disconnect, Series 2002

0.25 – 2.5 (4) mm² ① | AWG 22 – 12
 400 V/6 kV/3
 I_N 16 A
 Terminal block width 5.2 mm / 0.205 in
 10 – 12 mm / 0.43 in



0.25 – 2.5 (4) mm² ① | AWG 22 – 12
 400 V/6 kV/3
 I_N 16 A
 Terminal block width 5.2 mm / 0.205 in
 10 – 12 mm / 0.43 in

0.25 – 2.5 (4) mm² ① | AWG 22 – 12
 400 V/6 kV/3
 I_N 16 A
 Terminal block width 5.2 mm / 0.205 in
 10 – 12 mm / 0.43 in

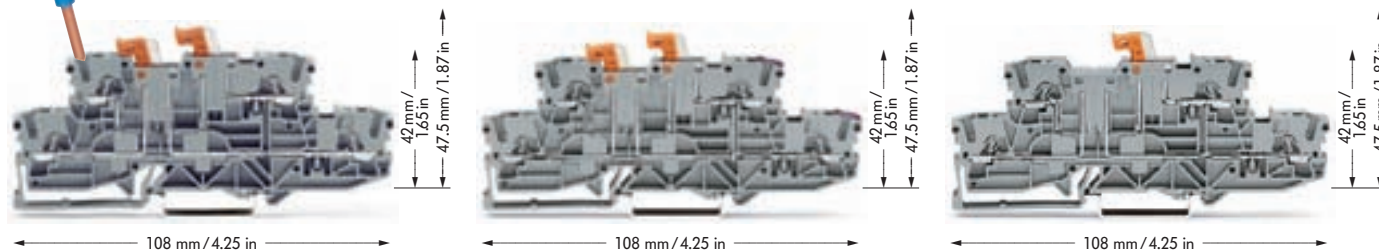
① can be connected: 0.25 mm² – 4 mm² "s + f-st";
 can be pushed in directly: 0.75 mm² – 4 mm² "s" and 0.75 mm² – 2.5 mm² "insulated ferrule, 12 mm/0.472 in"



Item No.	Pack.-unit pcs	Item No.	Pack.-unit pcs	Item No.	Pack.-unit pcs
4-conductor double deck double disconnect terminal blocks		4-conductor double deck double disconnect terminal blocks, lower deck and upper deck internally commoned on right side and with violet marking		4-conductor double deck disconnect terminal blocks, with disconnect on upper deck only, same profile as double deck double disconnect terminal blocks	
grey	2002-2951 ●	grey	2002-2958 ●	grey	2002-2971 ●
blue	2002-2954 ●	blue	2002-2959 ●	blue	2002-2974 ●
grey N/L	2002-2952 ●			grey N/L	2002-2972 ●
Item-specific accessories					
End and intermediate plate, 1 mm / 0.039 in thick		End and intermediate plate, 1 mm / 0.039 in thick		End and intermediate plate, 1 mm / 0.039 in thick	
	orange 2002-2992 100 (4 x 25)		orange 2002-2992 100 (4 x 25)		orange 2002-2992 100 (4 x 25)
	grey 2002-2991 100 (4 x 25)		grey 2002-2991 100 (4 x 25)		grey 2002-2991 100 (4 x 25)
Accessories Series 2002 appropriate marker system WMB/Marker strips/WMB Inline (see also Full Line Catalog W4 Volume 1, Section 14)					
Insulation stop, 5 pcs/strip		Protective warning marker,		Test plug, with cable 500 mm / 17.7"	
	200 strips		for 5 terminal blocks		Ø 2 mm / 0.079 in
	light grey 2002-171 0.25-0.5 mm ²		yellow 2002-115 100 (4 x 25)		red 210-136 50 (5 x 10)
	dark grey 2002-172 0.75-1 mm ²				
Push-in type jumper bars, light grey, insulated, I_N 25 A		Push-in type jumper bars, light grey, insulated, I_N 25 A		Staggered jumper, light grey, insulated, I_N 25 A	
	2-way 2002-402 200 (8 x 25)		1 - 3 2002-433 200 (8 x 25)		2-way 2002-472 100 (4 x 25)
	3-way 2002-403 200 (8 x 25)		1 - 4 2002-434 200 (8 x 25)		3-way 2002-473 100 (4 x 25)
	4-way 2002-404 200 (8 x 25)		1 - 5 2002-435 100 (4 x 25)		4-way 2002-474 100 (4 x 25)
	5-way 2002-405 100 (4 x 25)		:		5-way 2002-475 50 (2 x 25)
	:		:		:
	10-way 2002-410 100 (4 x 25)		1 - 10 2002-440 100 (4 x 25)		12-way 2002-482 50 (2 x 25)
Modular TOPJOB® S connector**, for jumper contact slot		Test plug adapter, for test plug Ø 4 mm / 0.157 in			
	1 pole 2002-511 100 (4 x 25)		2009-174 100 (4 x 25)		
Spacer, modular					
	2002-549 100 (4 x 25)				
		Testing tap, for max. 2.5 mm²/AWG 14			
		2009-182 100 (4 x 25)			

<p>0.25 – 1.5 (2.5) mm² AWG 22 – 14 U_N 250 V; U_{RM} 1000 V 1 N 4007 – 0.5 A continuous current Terminal block width 4.2 mm / 0.165 in  9 – 11 mm / 0.39 in</p>	<p>0,25 – 1,5 (2.5) mm² AWG 22 – 14 U_N 250 V; U_{RM} 1000 V 1 N 4007 – 0.5 A continuous current Terminal block width 4.2 mm / 0.165 in  9 – 11 mm / 0.39 in</p>	<p>0.25 – 1.5 (2.5) mm² AWG 22 – 14 DC 24 V I_F 0.025 A max. Terminal block width 4.2 mm / 0.165 in  9 – 11 mm / 0.39 in</p>
--	--	--

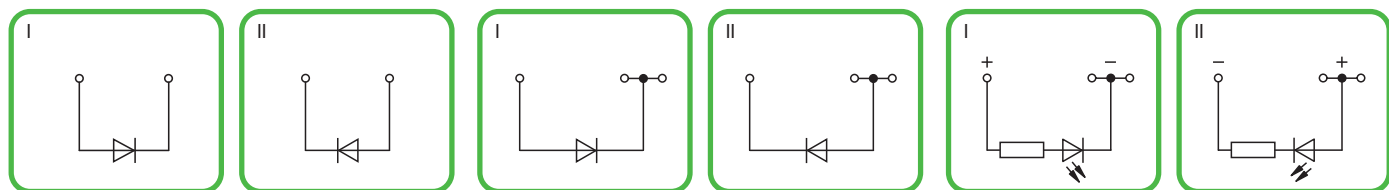
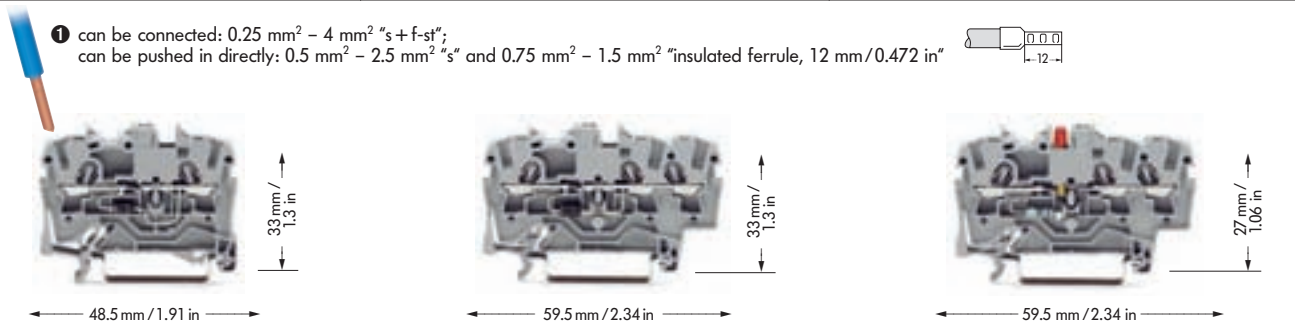

Item No.	Pack.-unit pcs	Item No.	Pack.-unit pcs	Item No.	Pack.-unit pcs
2-cond. diode term. blocks with diode 1 N 4007		3-cond. diode term. blocks with diode 1 N 4007		3-cond. LED term. blocks with red LED, DC 24 V	
Circuit I, grey	2001-1211/1000-410 100	Circuit I, grey	2001-1311/1000-410 100	Circuit I, grey	2001-1321/1000-434 100
Circuit II, grey	2001-1211/1000-411 100	Circuit II, grey	2001-1311/1000-411 100	Circuit II, grey	2001-1321/1000-413 100
Examples of circuit configuration see page see 21		Examples of circuit configuration see page see 21		Examples of circuit configuration see page see 21	
Through terminal block with the same shape		Through terminal block with the same shape		Through terminal block with the same shape	
grey	2001-1201	grey	2001-1301	grey	2001-1301
End and intermediate plate, 0.8 mm/0.032 in thick		End and intermediate plate, 0.8 mm/0.032 in thick		End and intermediate plate, 0.8 mm/0.032 in thick	
orange	2002-1292 100 (4 x 25)	orange	2002-1392 100 (4 x 25)	orange	2002-1392 100 (4 x 25)
grey	2002-1291 100 (4 x 25)	grey	2002-1391 100 (4 x 25)	grey	2002-1391 100 (4 x 25)

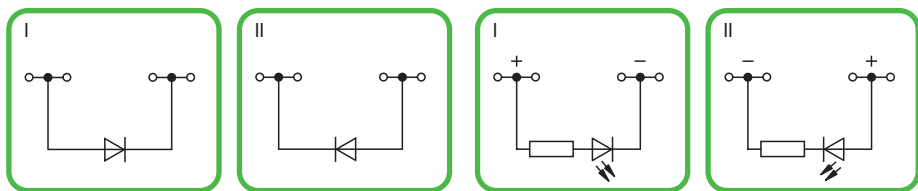
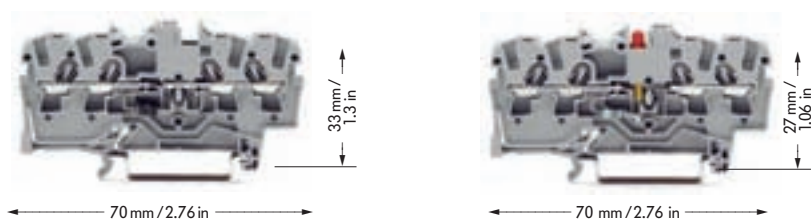

Item No.	Pack.-unit pcs	Item No.	Pack.-unit pcs	Item No.	Pack.-unit pcs
4-cond. diode term. blocks with diode 1 N 4007		4-cond. LED term. blocks with red LED, DC 24 V		4-cond. LED term. blocks with red LED, DC 24 V	
Circuit I, grey	2001-1411/1000-410 100	Circuit I, grey	2001-1421/1000-434 100	Circuit I, grey	2001-1421/1000-434 100
Circuit II, grey	2001-1411/1000-411 100	Circuit II, grey	2001-1421/1000-413 100	Circuit II, grey	2001-1421/1000-413 100
Examples of circuit configuration see page see 21		Examples of circuit configuration see page see 21		Examples of circuit configuration see page see 21	
Through terminal block with the same shape		Through terminal block with the same shape		Through terminal block with the same shape	
grey	2001-1401	grey	2001-1401	grey	2001-1401
End and intermediate plate, 0.8 mm/0.032 in thick		End and intermediate plate, 0.8 mm/0.032 in thick		End and intermediate plate, 0.8 mm/0.032 in thick	
orange	2002-1492 100 (4 x 25)	orange	2002-1492 100 (4 x 25)	orange	2002-1492 100 (4 x 25)
grey	2002-1491 100 (4 x 25)	grey	2002-1491 100 (4 x 25)	grey	2002-1491 100 (4 x 25)

TOPJOB® Diode Terminal Blocks 2.5 (4) mm² / AWG 12 and LED Terminal Blocks 2.5 (4) mm²; Series 2002

0.25 – 2.5 (4) mm² | AWG 22 – 12
U_N 250 V; U_{RM} 1000 V
1 N 4007 – 0.5 A continuous current
Terminal block width 5,2 mm / 0.205 in
10 – 12 mm / 0.43 in

0.25 – 2.5 (4) mm² | AWG 22 – 12
U_N 250 V; U_{RM} 1000 V
1 N 4007 – 0.5 A continuous current
Terminal block width 5.2 mm / 0.205 in
10 – 12 mm / 0.43 in

0.25 – 2.5 (4) mm² | AWG 22 – 12
DC 24 V
I_F 0.025 A max.
Terminal block width 5.2 mm / 0.205 in
10 – 12 mm / 0.43 in

① can be connected: 0.25 mm² – 4 mm² "s + f-st";
can be pushed in directly: 0.75 mm² – 4 mm² "s" and 0.75 mm² – 2.5 mm² "insulated ferrule, 12 mm/0.472 in"

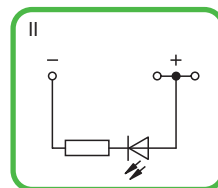
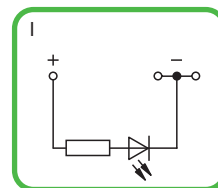
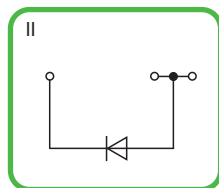
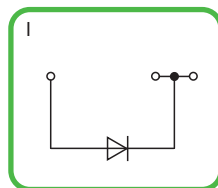
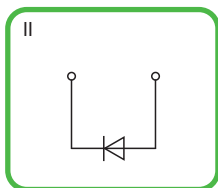
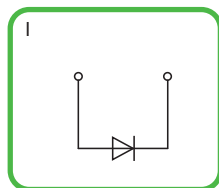
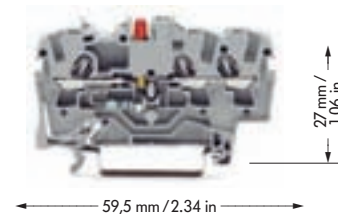
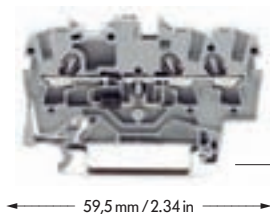
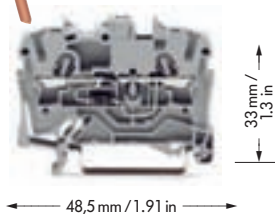



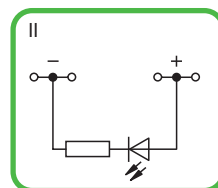
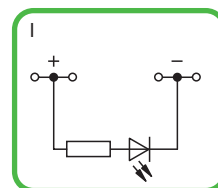
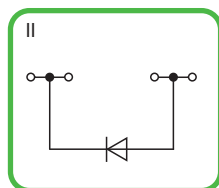
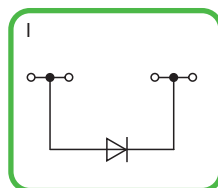
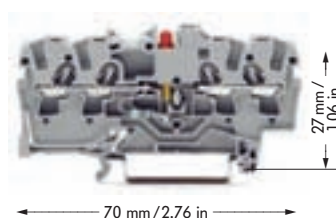
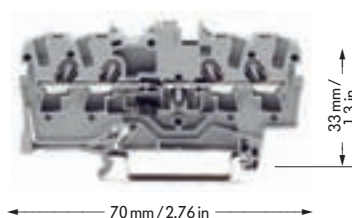

Item No.	Pack.-unit pcs	Item No.	Pack.-unit pcs	Item No.	Pack.-unit pcs
2-cond. diode term. blocks with diode 1 N 4007		3-cond. diode term. blocks with diode 1 N 4007		3-cond. LED term. blocks with red LED, DC 24 V	
Circuit I, grey	2002-1211/1000-410 100	Circuit I, grey	2002-1311/1000-410 100	Circuit I, grey	2002-1321/1000-434 100
Circuit II, grey	2002-1211/1000-411 100	Circuit II, grey	2002-1311/1000-411 100	Circuit II, grey	2002-1321/1000-413 100
Examples of circuit configuration see page see 21		Examples of circuit configuration see page see 21		Examples of circuit configuration see page see 21	
Through terminal block with the same shape		Through terminal block with the same shape		Through terminal block with the same shape	
grey	2002-1201	grey	2002-1301	grey	2002-1301
End and intermediate plate, 0.8 mm/0.032 in thick		End and intermediate plate, 0.8 mm/0.032 in thick		End and intermediate plate, 0.8 mm/0.032 in thick	
orange	2002-1292 100 (4 x 25)	orange	2002-1392 100 (4 x 25)	orange	2002-1392 100 (4 x 25)
grey	2002-1291 100 (4 x 25)	grey	2002-1391 100 (4 x 25)	grey	2002-1391 100 (4 x 25)



Item No.	Pack.-unit pcs	Item No.	Pack.-unit pcs
4-cond. diode term. blocks with diode 1 N 4007		4-cond. LED term. blocks with red LED, DC 24 V	
Circuit I, grey	2002-1411/1000-410 100	Circuit I, grey	2002-1421/1000-434 100
Circuit II, grey	2002-1411/1000-411 100	Circuit II, grey	2002-1421/1000-413 100
Examples of circuit configuration see page see 21		Examples of circuit configuration see page see 21	
Through terminal block with the same shape		Through terminal block with the same shape	
grey	2002-1401	grey	2002-1401
End and intermediate plate, 0.8 mm/0.032 in thick		End and intermediate plate, 0.8 mm/0.032 in thick	
orange	2002-1492 100 (4 x 25)	orange	2002-1492 100 (4 x 25)
grey	2002-1491 100 (4 x 25)	grey	2002-1491 100 (4 x 25)

Accessories Series 2001	Accessories Series 2002	
-------------------------	-------------------------	--

Item No.	Pack.-unit pcs	Item No.	Pack.-unit pcs
Push-in type jumper bars, light grey, insulated, I_N 18 A		Push-in type jumper bars, light grey, insulated, I_N 25 A	
	2-way 2001-402 200 (8 x 25)		2-way 2002-402 200 (8 x 25)
	3-way 2001-403 200 (8 x 25)		3-way 2002-403 200 (8 x 25)
	4-way 2001-404 200 (8 x 25)		4-way 2002-404 200 (8 x 25)
	5-way 2001-405 100 (4 x 25)		5-way 2002-405 100 (4 x 25)
:	:	:	:
	10-way 2001-410 100 (4 x 25)		10-way 2002-410 100 (4 x 25)
Push-in type jumper bars, light grey, insulated, I_N 18 A		Push-in type jumper bars, light grey, insulated, I_N 25 A	
	1 - 3 2001-433 200 (8 x 25)		1 - 3 2002-433 200 (8 x 25)
	1 - 4 2001-434 200 (8 x 25)		1 - 4 2002-434 200 (8 x 25)
	1 - 5 2001-435 100 (4 x 25)		1 - 5 2002-435 100 (4 x 25)
:	:	:	:
	1 - 10 2001-440 100 (4 x 25)		1 - 10 2002-440 100 (4 x 25)

Examples of circuit configuration

2-conductor diode terminal block

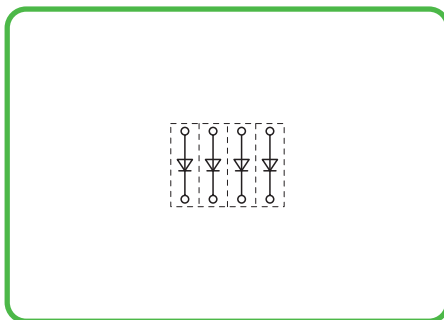

Open diode gate

3-conductor diode terminal block

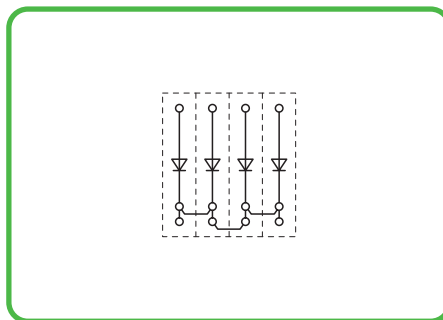

Polarized diode gate, common cathode

4-conductor diode terminal block

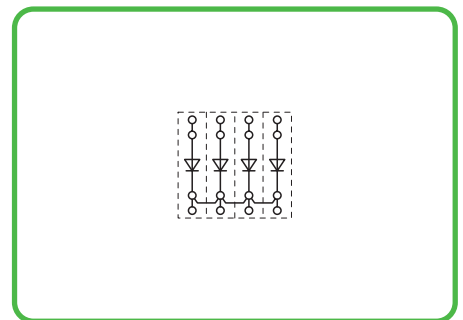

Polarized diode gate, common cathode

3-conductor LED terminal block

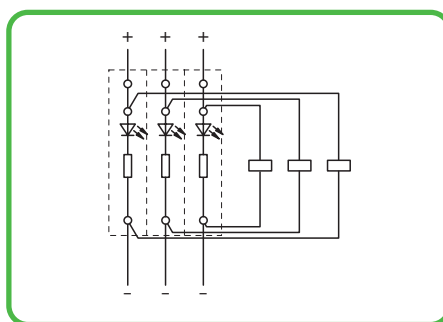

Voltage indication

4-conductor LED terminal block

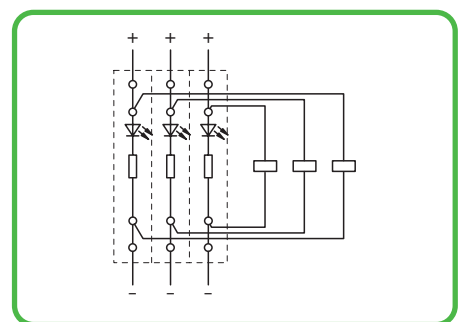

Voltage indication

Double Deck Diode Terminal Blocks / Double Deck LED Terminal Blocks 2.5 mm²/4 mm² / AWG 12, Series 2002

	0.25 – 2.5 (4) mm ² ① AWG 22 – 12 U _N 250 V; U _{RM} 1000 V 1 N 4007 – 0.5 A continuous current Terminal block width 5.2 mm / 0.205 in 10 – 12 mm / 0.43 in	0.25 – 2.5 (4) mm ² ① AWG 22 – 12 U _N 250 V; U _{RM} 1000 V 1 N 4007 – 0.5 A continuous current Terminal block width 5.2 mm / 0.205 in 10 – 12 mm / 0.43 in
--	---	---

① can be connected: 0.25 mm² – 4 mm² "s + f-st";
 can be pushed in directly: 0.75 mm² – 4 mm² "s" and
 0.75 mm² – 2.5 mm² "insulated ferrule, 12 mm/0.472 in"

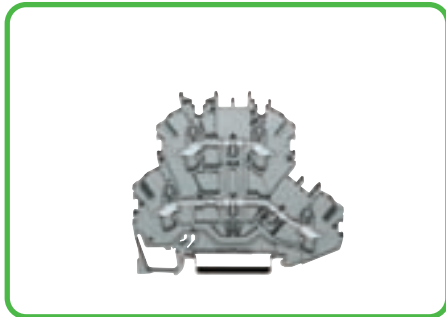
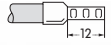

Through terminal blocks with the same shape see page 6

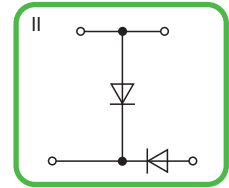
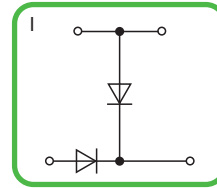
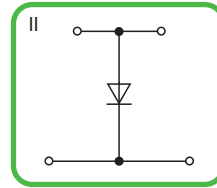
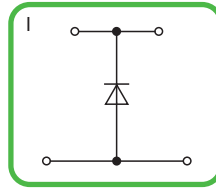
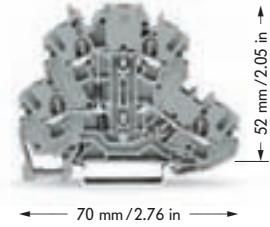
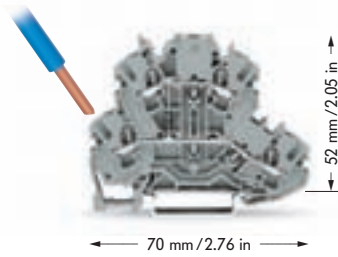

Description	Item No.	Pack. unit pcs	Item No.	Pack. unit pcs
Double deck diode terminal block	Double deck diode terminal blocks with diode 1 N 4007		Double deck diode terminal blocks with 2 diodes 1 N 4007	
and	Circuit I, grey	2002-2211/1000-0410 50	Circuit I, grey	2002-2214/1000-0492 50
double deck LED terminal block, for DIN 35 rail	Circuit II, grey	2002-2211/1000-0411 50	Circuit II, grey	2002-2214/1000-0491 50

Accessories

Appropriate marking system **WMB/WMB Inline** (see also Full Line Catalog W4 Volume 1, Section 14)

	0.8 mm / 0.032 in thick	0.8 mm / 0.032 in thick
	End and intermediate plate	
	orange 2002-2292 100 (4 x 25) grey 2002-2291 100 (4 x 25)	orange 2002-2292 100 (4 x 25) grey 2002-2291 100 (4 x 25)
	Push-in type jumper bars,	
	light grey, insulated, I _N 25 A	
	2-way 2002-402 200 (8 x 25)	2-way 2002-402 200 (8 x 25)
	3-way 2002-403 200 (8 x 25)	3-way 2002-403 200 (8 x 25)
	4-way 2002-404 200 (8 x 25)	4-way 2002-404 200 (8 x 25)
	5-way 2002-405 100 (4 x 25)	5-way 2002-405 100 (4 x 25)
	10-way 2002-410 100 (4 x 25)	10-way 2002-410 100 (4 x 25)
	1 - 3 2002-433 200 (8 x 25)	1 - 3 2002-433 200 (8 x 25)
	1 - 4 2002-434 200 (8 x 25)	1 - 4 2002-434 200 (8 x 25)
	1 - 5 2002-435 100 (4 x 25)	1 - 5 2002-435 100 (4 x 25)
	1 - 10 2002-440 100 (4 x 25)	1 - 10 2002-440 100 (4 x 25)
	Two-way marking adapter, pivotable	2002-121 50 (2 x 25)

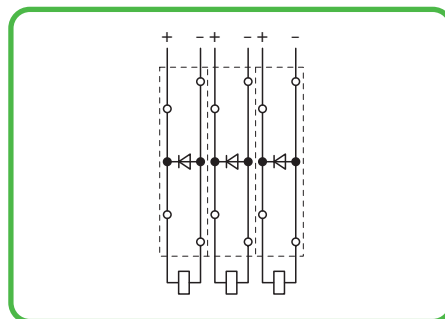

Examples of circuit configuration

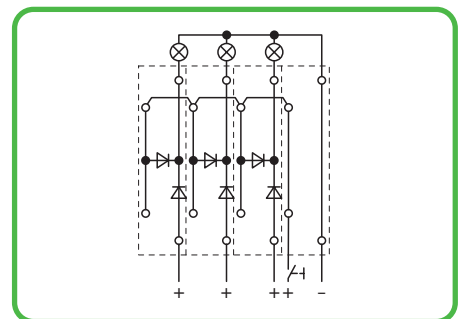

Used as recovery diodes



Used in lamp test circuit

<p>0.25 – 2.5 (4) mm² ① AWG 22 – 12 U_N 250 V; U_{RM} 1000 V 1 N 4007 – 0.5 A continuous current</p> <p>Terminal block width 5.2 mm / 0.205 in  10 – 12 mm / 0.43 in</p>	<p>0.25 – 2.5 (4) mm² ① AWG 22 – 12 U_N 250 V; U_{RM} 1000 V 1 N 4007 – 0.5 A continuous current</p> <p>Terminal block width 5.2 mm / 0.205 in  10 – 12 mm / 0.43 in</p>	<p>0.25 – 2.5 (4) mm² ① AWG 22 – 12 DC 24 V I_F 25 mA max.</p> <p>Terminal block width 5.2 mm / 0.205 in  10 – 12 mm / 0.43 in</p>
---	---	---

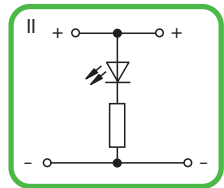
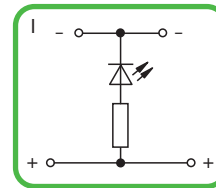
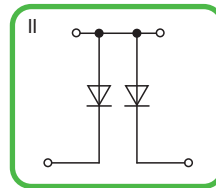
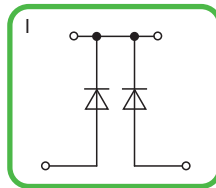
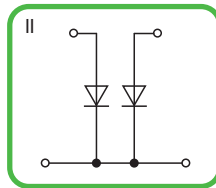
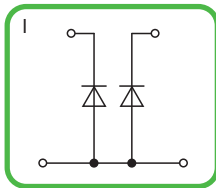
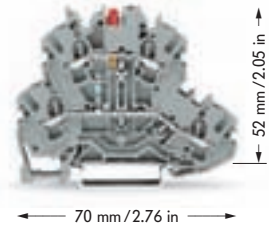
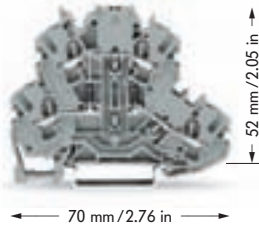
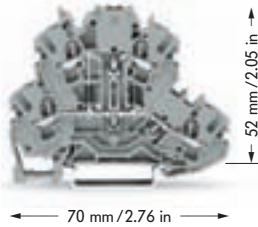

Item No.	Pack. unit pcs	Item No.	Pack. unit pcs	Item No.	Pack. unit pcs
Double deck diode terminal blocks with 2 diodes 1 N 4007		Double deck diode terminal blocks with 2 diodes 1 N 4007		Double deck LED terminal blocks with red LED, DC 24 V	
Circuit I, grey	2002-2213/1000-0487 50	Circuit I, grey	2002-2214/1000-0489 50	Circuit I, grey	2002-2221/1000-0434 50
Circuit II, grey	2002-2213/1000-0488 50	Circuit II, grey	2002-2214/1000-0490 50	Circuit II, grey	2002-2221/1000-0413 50

Appropriate marking system **WMB/WMB Inline** (see also Full Line Catalog W4 Volume 1 Section 14)

0.8 mm / 0.032 in thick			0.8 mm / 0.032 in thick			0.8 mm / 0.032 in thick		
orange	2002-2292	100 (4 x 25)	orange	2002-2292	100 (4 x 25)	orange	2002-2292	100 (4 x 25)
grey	2002-2291	100 (4 x 25)	grey	2002-2291	100 (4 x 25)	grey	2002-2291	100 (4 x 25)
2-way	2002-402	200 (8 x 25)	2-way	2002-402	200 (8 x 25)	2-way	2002-402	200 (8 x 25)
3-way	2002-403	200 (8 x 25)	3-way	2002-403	200 (8 x 25)	3-way	2002-403	200 (8 x 25)
4-way	2002-404	200 (8 x 25)	4-way	2002-404	200 (8 x 25)	4-way	2002-404	200 (8 x 25)
5-way	2002-405	100 (4 x 25)	5-way	2002-405	100 (4 x 25)	5-way	2002-405	100 (4 x 25)
:	:	:	:	:	:	:	:	:
10-way	2002-410	100 (4 x 25)	10-way	2002-410	100 (4 x 25)	10-way	2002-410	100 (4 x 25)
1 - 3	2002-433	200 (8 x 25)	1 - 3	2002-433	200 (8 x 25)	1 - 3	2002-433	200 (8 x 25)
1 - 4	2002-434	200 (8 x 25)	1 - 4	2002-434	200 (8 x 25)	1 - 4	2002-434	200 (8 x 25)
1 - 5	2002-435	100 (4 x 25)	1 - 5	2002-435	100 (4 x 25)	1 - 5	2002-435	100 (4 x 25)
:	:	:	:	:	:	:	:	:
1 - 10	2002-440	100 (4 x 25)	1 - 10	2002-440	100 (4 x 25)	1 - 10	2002-440	100 (4 x 25)
	2002-121	50 (2 x 25)		2002-121	50 (2 x 25)		2002-121	50 (2 x 25)

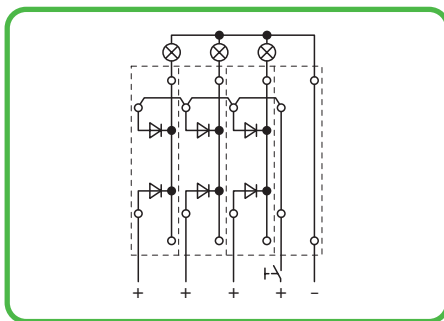

Used in lamp test circuit

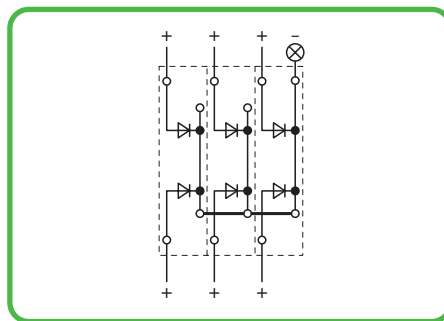

Used for collective fault indication

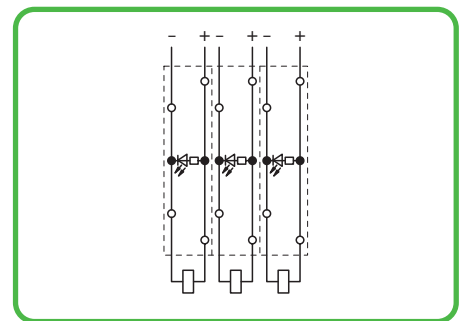

Used for voltage indication

Triple Deck Diode Terminal Blocks / Triple Deck LED Terminal Blocks
2.5 mm²/4 mm² / AWG 12, Series 2002

	<p>0.25 – 2.5 (4) mm² AWG 22 – 12 U_N 250 V; U_{RM} 1000 V 1 N 4007 – 0.5 A continuous current</p> <p>Terminal block width 5.2 mm / 0.205 in 10 – 12 mm / 0.43 in</p>	<p>0.25 – 2.5 (4) mm² AWG 22 – 12 U_N 250 V; U_{RM} 1000 V 1 N 4007 – 0.5 A continuous current</p> <p>Terminal block width 5.2 mm / 0.205 in 10 – 12 mm / 0.43 in</p>
--	---	---

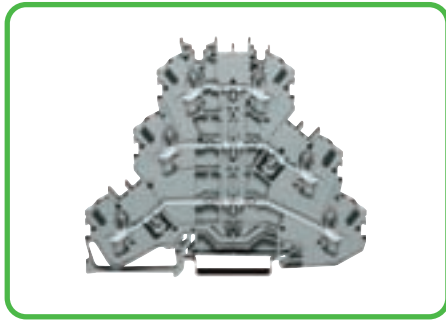

Through terminal blocks with the same shape see page 7

1 can be connected: 0.25 mm² – 4 mm² "s + f-st";
 can be pushed in directly: 0.75 mm² – 4 mm² "s" and 0.75 mm² – 2.5 mm² "insulated ferrule, 12 mm/0.472 in"

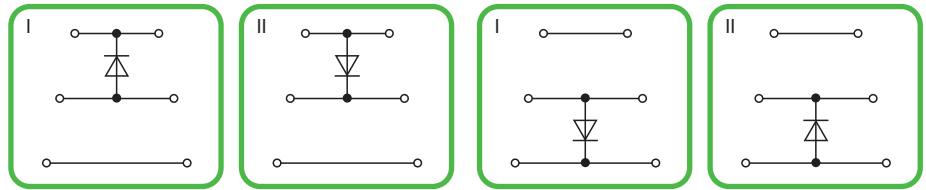
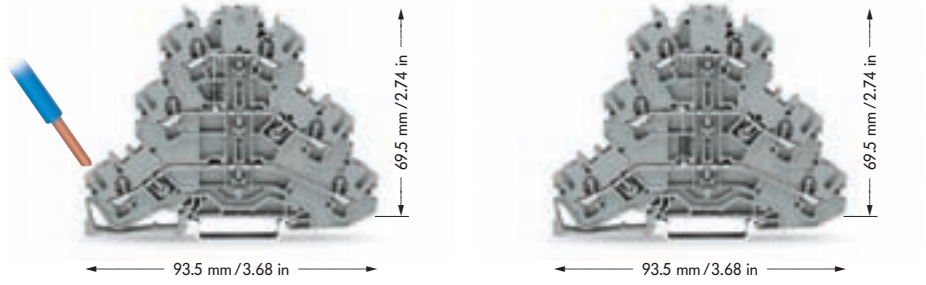



Description	Item No.	Pack. unit pcs	Item No.	Pack. unit pcs
Triple deck diode terminal block and Triple deck LED terminal block , for DIN 35 rail	Triple deck diode terminal blocks with diode 1 N 4007		Triple deck diode terminal blocks with diode 1 N 4007	
	Circuit I, grey	2002-3211/1000-0410 50	Circuit I, grey	2002-3211/1000-0675 50
	Circuit II, grey	2002-3211/1000-0411 50	Circuit II, grey	2002-3211/1000-0676 50

Accessories

Appropriate marking system **WMB/WMB Inline** (see also Full Line Catalog W4 Volume 1, Section 14)

		0.8 mm / 0.032 in thick		0.8 mm / 0.032 in thick	
	End and intermediate plate	orange	2002-3292 100 (4 x 25)	orange	2002-3292 100 (4 x 25)
		grey	2002-3291 100 (4 x 25)	grey	2002-3291 100 (4 x 25)
	Push-in type jumper bars , light grey, insulated, I _N 25 A	2-way	2002-402 200 (8 x 25)	2-way	2002-402 200 (8 x 25)
		3-way	2002-403 200 (8 x 25)	3-way	2002-403 200 (8 x 25)
		4-way	2002-404 200 (8 x 25)	4-way	2002-404 200 (8 x 25)
		5-way	2002-405 100 (4 x 25)	5-way	2002-405 100 (4 x 25)
		:	:	:	:
		10-way	2002-410 100 (4 x 25)	10-way	2002-410 100 (4 x 25)
	Push-in type jumper bars , light grey, insulated, I _N 25 A	1 - 3	2002-433 200 (8 x 25)	1 - 3	2002-433 200 (8 x 25)
		1 - 4	2002-434 200 (8 x 25)	1 - 4	2002-434 200 (8 x 25)
		1 - 5	2002-435 100 (4 x 25)	1 - 5	2002-435 100 (4 x 25)
		:	:	:	:
		1 - 10	2002-440 100 (4 x 25)	1 - 10	2002-440 100 (4 x 25)
			Two-way marking adapter , pivotable		2002-131 50 (2 x 25)

<p>0.25 – 2.5 (4) mm² ① AWG 22 – 12 U_N 250 V; U_{RM} 1000 V 1 N 4007 – 0.5 A continuous current</p> <p>Terminal block width 5.2 mm / 0.205 in  10 – 12 mm / 0.43 in</p>	<p>0.25 – 2.5 (4) mm² ① AWG 22 – 12 DC 24 V I_F 25 mA max.</p> <p>Terminal block width 5.2 mm / 0.205 in  10 – 12 mm / 0.43 in</p>
---	---

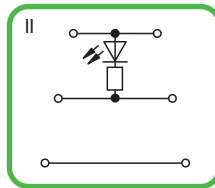
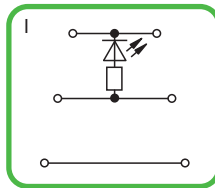
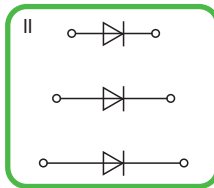
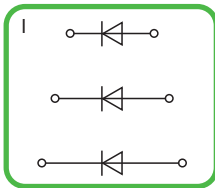
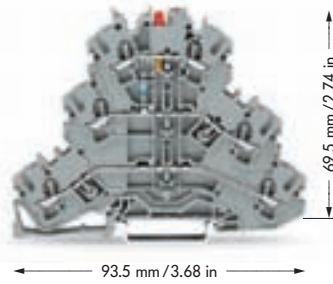
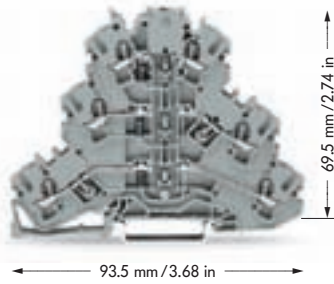

Item No.	Pack. unit pcs	Item No.	Pack. unit pcs
Triple deck diode terminal blocks with 3 diodes 1 N 4007		Triple deck LED terminal blocks with red LED, DC 24 V	
Circuit I, grey	2002-3212/1000-0673 50	Circuit I, grey	2002-3221/1000-0434 50
Circuit II, grey	2002-3212/1000-0674 50	Circuit II, grey	2002-3221/1000-0413 50

Appropriate marking system **WMB/WMB Inline** (see also Full Line Catalog W4 Volume 1 Section 14)

0.8 mm / 0.032 in thick			0.8 mm / 0.032 in thick		
orange	2002-3292	100 (4 x 25)	orange	2002-3292	100 (4 x 25)
grey	2002-3291	100 (4 x 25)	grey	2002-3291	100 (4 x 25)
2-way	2002-402	200 (8 x 25)	2-way	2002-402	200 (8 x 25)
3-way	2002-403	200 (8 x 25)	3-way	2002-403	200 (8 x 25)
4-way	2002-404	200 (8 x 25)	4-way	2002-404	200 (8 x 25)
5-way	2002-405	100 (4 x 25)	5-way	2002-405	100 (4 x 25)
:	:		:	:	
10-way	2002-410	100 (4 x 25)	10-way	2002-410	100 (4 x 25)
1 - 3	2002-433	200 (8 x 25)	1 - 3	2002-433	200 (8 x 25)
1 - 4	2002-434	200 (8 x 25)	1 - 4	2002-434	200 (8 x 25)
1 - 5	2002-435	100 (4 x 25)	1 - 5	2002-435	100 (4 x 25)
:	:		:	:	
1 - 10	2002-440	100 (4 x 25)	1 - 10	2002-440	100 (4 x 25)
	2002-131	50 (2 x 25)		2002-131	50 (2 x 25)

Push-in Type Wire Jumpers and Star Point Jumpers

Wire jumpers Nominal voltage: 800 V/8 kV/3 Nominal current: 16 A Nominal cross section: 1.5 mm ² /AWG 16 Conductor lengths: 60/110/250 mm 2.36/4.33/9.84 in	Star point jumpers Nominal voltage: 800 V/8 kV/3 Nominal current: $I_N \triangleq I_N$ Terminal block of the relevant series
--	---



Item No.	Pack.-unit pcs	Item No.	Pack.-unit pcs
Push-in type wire jumpers, insulated, conductor cross section 1.5 mm ² /AWG 16, suitable for rail-mounted terminal blocks series 2001 and 2002		Star Point Jumpers, light grey, insulated suitable for series	
Wire length		2002	2002-0405/0011-000
60 mm / 2.36 in	2009-412 10	2004	2004-0405/0011-000
110 mm / 4.33 in	2009-414 10	2006	2006-0405/0011-000
250 mm / 9.84 in	2009-416 10	2010	2010-0405/0011-000
		2016	2016-0405/0011-000

Applications notes



Push down the wire jumper until fully inserted. Lift the jumper with a screwdriver for rewiring.

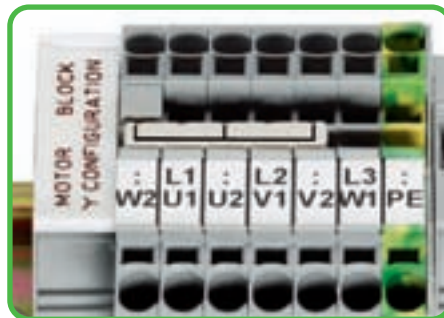

This jumper has been specially developed to create a "star point" and is used on motor terminal boards equipped with TOPJOB® rail-mounted terminal blocks.

1 WAGO Marking System WMB Inline Series 2009

VOLUME 1

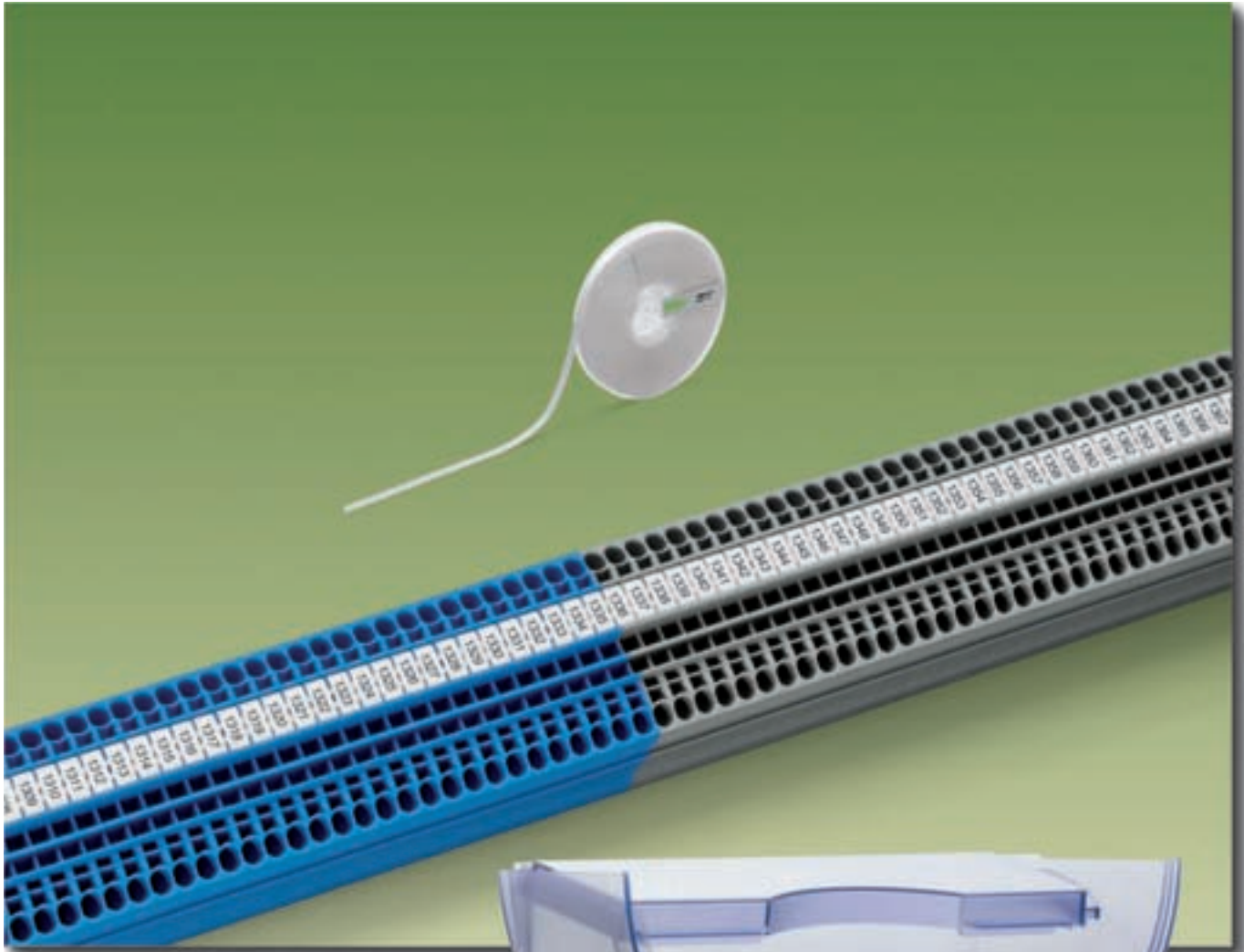

Marking

WMB or miniature WSB markers can be used in three positions of the TOPJOB® S products. Moreover, a full length marking strip can be used in the top position of a terminal block. The terminal blocks from 1.5 mm²/AWG 16 to 6 mm²/AWG 10 as well as 10 mm²/AWG 8 and 16 mm²/AWG 6 are at the same height which allows quick marking even of terminal blocks of different sizes. The WAGO "smart Designer" software and a thermal transfer printer generate the marking.

WMB – Inline

- Markers "from the roll" save time and money
- A thermal transfer printer and the WAGO "smart Designer" software generate the marking
- Markers fit 5 mm / 0.197 in and 5.2 mm / 0.205 in wide terminal blocks and can hence be used for all 2.5 mm² WAGO rail-mounted terminal blocks
- Can be separated easily
- When separated they can also be fitted on all wider WAGO rail-mounted terminal blocks

WMB Inline, pitch 5 mm / 0.197 in,
for 5 mm / 0.197 in and 5.2 mm / 0.205 in,
on roll, 10 m
white **2009-115** 1 roll
1500 markers / roll

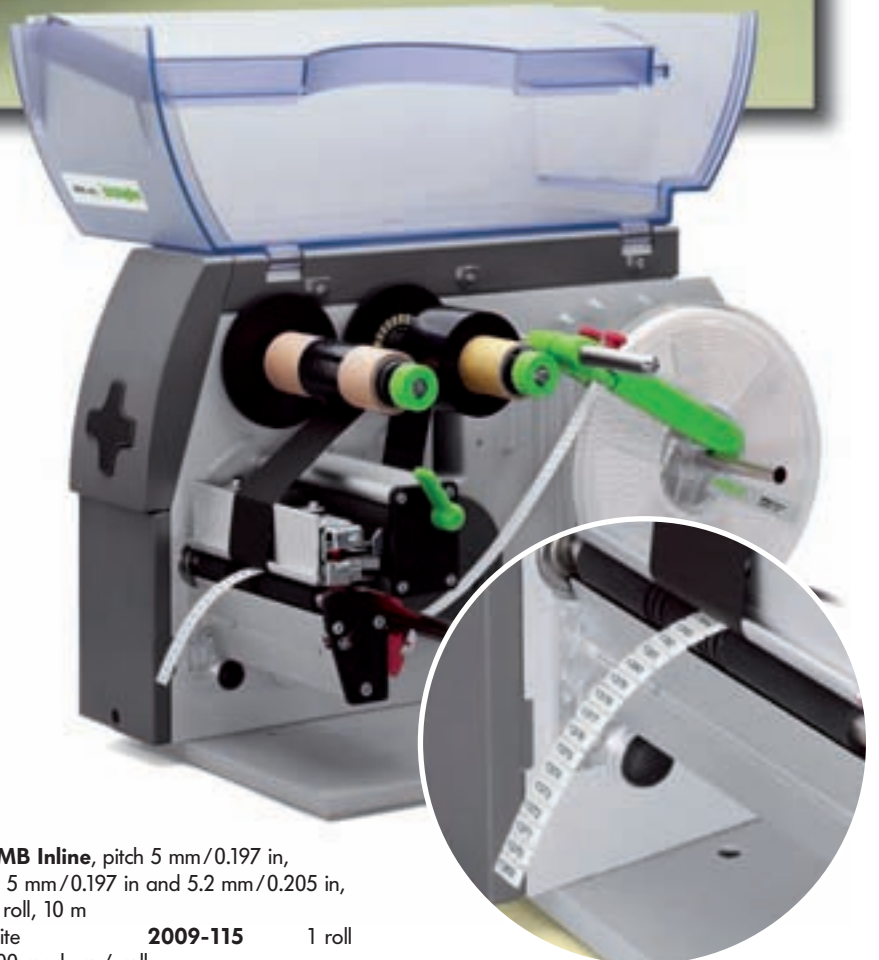

The Range of Rail Mounted Terminal Blocks
for Wire Sizes Ranging from 6 mm² – 95 mm²/AWG 8 to AWG 4/0

Connecting conductors up to 95 mm²/AWG 4/0 with a turn of the hand

The 285 Series of rail-mounted terminal blocks are suitable for applications with rated currents up to 232 A. Based on a unique patented technology, the largest version,

285-195, rated for **25-95 mm²/AWG 4 to AWG 4/0** has been holding its ground in the market for many years.

Now, two additional terminal blocks for wire sizes down to 6 mm² (AWG 8) have been added to the range:

285-135, 6–35 mm²/AWG 8 to AWG 2

285-150, 10–50 mm²/AWG 8 to 2/0 (70 mm² "f-st").

Operation of these new terminals is essentially the same as the 95 mm² terminal block. **The 35 mm² terminal block has the following differences.**



In addition to the WMB marking system, custom marking strips can also be used.

Testing using plug adapters for Ø 4 mm plugs.

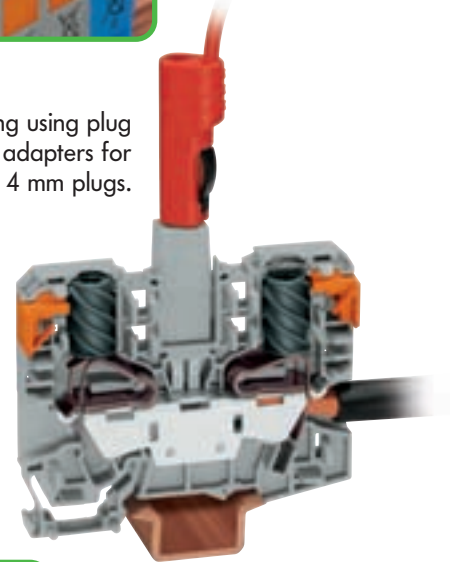

Commoning adjacent terminal blocks using centrally positioned adjacent jumper.



Move the marking strip laterally to remove the jumper.

Counter-clockwise rotation using a screwdriver 5.5 mm/0.217 in. Hold clamp in open position using the latch.



Introduce stripped wire into the clamping unit up to the stop and hold it in position . . .



. . . A small counter-clockwise rotation releases the latch ①. Once the screwdriver ② has been removed the conductor is safely clamped.

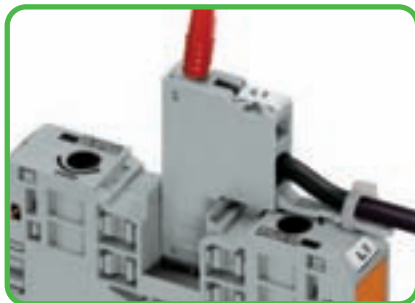

The voltage tap is inserted into the jumper contact slot. It can be fitted with a strain relief plate and provides test option for Ø 2 mm test sockets.



Side entry wiring means that even larger cables, which are flexible to a limited degree, can be connected without a problem.

High Current Through/Ground (Earth) Conductor Terminal Blocks

35 mm²/AWG 2, Series 285, Side-entry

POWER
CAGE CLAMP®

2

VOLUME 1

<p>6 – 35 mm² 1000 V/8 kV/3 ① I_N 125 A</p> <p>Terminal block width 16 mm / 0.63 in 25 – 26 mm / 0.98 in</p>	<p>AWG 8 – 2 600 V, 115 A Ⅲ 600 V</p> <p>Terminal block width 16 mm / 0.63 in 25 – 26 mm / 0.98 in</p>	<p>6 – 35 mm²</p> <p>Terminal block width 16 mm / 0.63 in 25 – 26 mm / 0.98 in</p>	<p>AWG 8 – 2</p> <p>Terminal block width 16 mm / 0.63 in 25 – 26 mm / 0.98 in</p>	<p>0.2 – 6 mm² 800 V/8 kV/3 I_N 32 A</p> <p>Terminal block width 8 mm / 0.315 in 12 – 13 mm / 0.49 in</p>	<p>AWG 24 – 10</p> <p>Terminal block width 8 mm / 0.315 in 12 – 13 mm / 0.49 in</p>
---	--	---	---	--	---

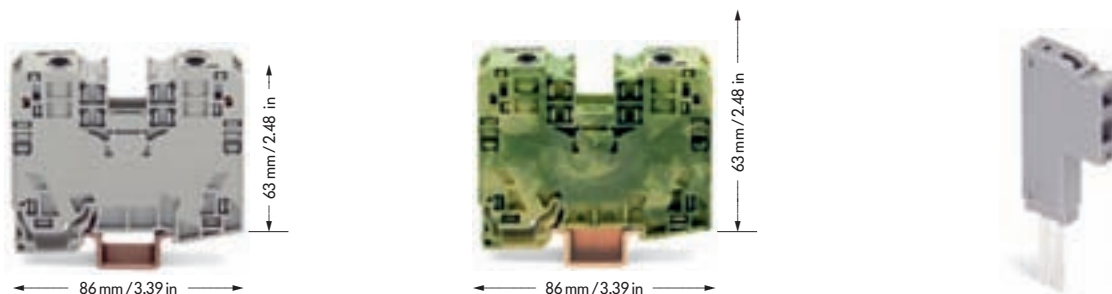



Item No.	Pack. unit pcs	Item No.	Pack. unit pcs	Item No.	Pack. unit pcs
2-conductor through terminal blocks		2-conductor ground (earth) terminal blocks		Voltage tap,	
grey 285-135 ●	15	green-yellow 285-137 ●	15	grey 285-427 ●	5
blue 285-134 ●	15				
To be used exclusively on DIN 35 x 15; 2.3 mm / 0.091 in thick		To be used exclusively on DIN 35 x 15; 2.3 mm / 0.091 in thick, Cu			
Accessories Appropriate marking system WMB/Marker strips (see W4 Volume 1, Section 14)			Appropriate marking system WMB		
Adjacent jumper, insulated, I _N 100 A for 1 jumper I _N 85 A for 2 to 4 jumpers grey 285-435 50 (2 x 25)		Adjacent jumper, insulated, I _N 100 A for 1 jumper I _N A for 2 to 4 jumpers grey 285-435 50 (2 x 25)		Strain relief plate, snap-on type for voltage tap grey 769-410 100 (4 x 25)	
Screwdriver with partially insulated shaft, type 3, blade 5.5 x 0.8 mm / 0.217 in x 0.031 in 210-621 1		crewdriver with partially insulated shaft, type 3, blade 5.5 x 0.8 mm / 0.217 in x 0.031 in 210-621 1		Test plug, with cable 500 mm/17.7" 2 mm Ø, red 210-136 50 (5 x 10)	
Protective warning marker, with high voltage symbol, black yellow 285-420 50 (2 x 25)		Protective warning marker, with high voltage symbol, black yellow 285-420 50 (2 x 25)		① 1000 V = rated voltage 8 kV = rated surge voltage 3 = pollution degree (see also Full Line Catalog W4 Volume 1, Section 15)	
Finger guard cover, serves as touchproof protec- tion for unused clamping units yellow 285-421 25		Finger guard cover, serves as touchproof protec- tion for unused clamping units yellow 285-421 25			
Test plug adapter, 11.6 mm/4.57 in wide, for test plug 4 mm/0.157 in Ø 283-404 25		Test plug adapter, 11.6 mm/4.57 in wide, for test plug 4 mm/0.157 in Ø 283-404 25			
Test plug, Ø 4 mm/0.157 in, protected against accidental contact, not offered by WAGO e.g. Fa. Multi-Contact Deutschland GmbH Postfach 16 06 · 79551 Weil am Rhein Hegenheimerstraße 19 · 79576 Weil am Rhein		Test plug, Ø 4 mm/0.157 in, protected against accidental contact, not offered by WAGO e.g. Fa. Multi-Contact Deutschland GmbH Postfach 16 06 · 79551 Weil am Rhein Hegenheimerstraße 19 · 79576 Weil am Rhein			

2 High Current Through/Ground (Earth) Conductor Terminal Blocks

50 (70 "f-st") mm²/AWG 2/0; Series 285, Side-entry

POWER
CAGE CLAMP®

VOLUME 1

<p>10 – 50 (70 "f-st") mm² AWG 8 – 2/0 1000 V/8 kV/3 Ⓢ 600 V I_N 150 A 600 V</p> <p>Terminal block width 20 mm / 0.78 in  30 mm / 1.18 in</p>	<p>10 – 50 (70 "f-st") mm² AWG 8 – 2/0</p> <p>Terminal block width 20 mm / 0.78 in  30 mm / 1.18 in</p>	<p>2 x 0,2 – 6 mm² AWG 24 – 10 1000 V/8 kV/3 I_N 41 A</p> <p>Module width 16 mm / 0.63 in  12 – 13 mm / 0.49 in</p>
--	--	--

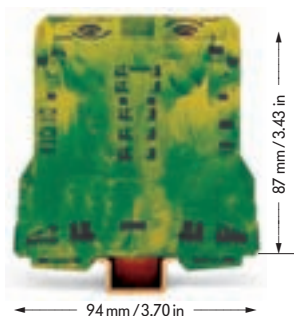
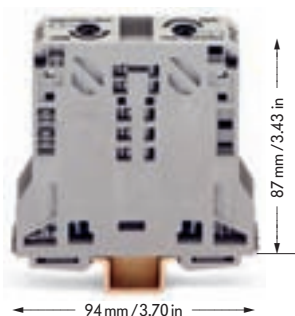

Item No.	Pack. unit pcs	Item No.	Pack. unit pcs	Item No.	Pack. unit pcs
2-conductor through terminal blocks		2-conductor ground (earth) terminal blocks		Voltage tap,	
grey	285-150 ● 5	green-yellow	285-157 ● 5	grey	285-447 ● 5
blue	285-154 ● 5				
To be used exclusively on DIN 35 x 15; 2.3 mm / 0.091 in thick		To be used exclusively on DIN 35 x 15; 2.3 mm / 0.091 in thick, Cu			

Accessories		Appropriate marking system WMB (see Full Line Catalog W4 Volume 1, Section 14)		Appropriate marking system WMB	
Adjacent jumper, insulated, I _N 150 A grey	285-450 25	Adjacent jumper, insulated, I _N 150 A grey	285-450 25	① 1000 V = rated voltage 8 kV = rated surge voltage 3 = pollution degree (see also Full Line Catalog W4 Volume 1, Section 15)	
Hex wrench with partially insulated shaft	285-172 1	Hex wrench with partially insulated shaft	285-172 1		
Protective warning marker, with high voltage symbol, black yellow	285-420 50 (2x25)	Protective warning marker, with high voltage symbol, black yellow	285-420 50 (2x25)		
Finger guard cover, serves as touchproof protection for unused clamping units yellow	285-421 25	Finger guard cover, serves as touchproof protection for unused clamping units yellow	285-421 25		
Test plug, Ø 4 mm / 0.157 in, protected against accidental contact, not offered by WAGO e.g. Fa. Multi-Contact Deutschland GmbH Postfach 16 06 · 79551 Weil am Rhein Hegenheimerstraße 19 · 79576 Weil am Rhein		Test plug, Ø 4 mm / 0.157 in, protected against accidental contact, not offered by WAGO e.g. Fa. Multi-Contact Deutschland GmbH Postfach 16 06 · 79551 Weil am Rhein Hegenheimerstraße 19 · 79576 Weil am Rhein			

Collective Carrier for Standard and Special Jumpers, Series 282

Collective carrier for standard and special jumpers in longitudinal disconnect and transverse switch terminal blocks, Series 282, can be snapped onto DIN 35 rail
 Width 15.8 mm / 0.62 in
 (± 2 x pitch 8 mm)

Storage

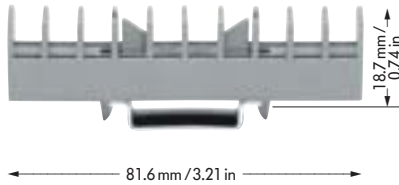

Safe storage for jumpers that are only needed temporarily in longitudinal disconnect and transverse switch terminal blocks.

Jumpers are used as a "switch" for the transformer short circuit, for example with the longitudinal disconnect terminal blocks. Pre-locking positions in the terminal blocks hold the jumpers captive during normal operation. For users who prefer to store the jumpers outside the terminal block, the collective carrier is an ideal solution.

Item No.	Pack. unit pcs	
Collective carrier for jumpers		
282-369	25	
Suitable for jumpers for		
transverse switch t. bl.	282-811 and	
longitudinal disc. t. bl.	282-821	
Appropriate for the following jumpers:		
Jumpers, orange, I_N 30 A		
	2-way	282-432 50 (5 x 10)
	3-way	282-433 50 (5 x 10)
	4-way	282-434 50 (5 x 10)
	5-way	282-435 50 (5 x 10)
	6-way	282-436 50 (5 x 10)
	7-way	282-437 50 (5 x 10)
	8-way	282-438 50 (5 x 10)
	9-way	282-439 50 (5 x 10)
	10-way	282-440 50 (5 x 10)
Jumpers, special version, orange, I_N 30 A		
	3-way (1-3-5)	282-435/011-000 50 (5 x 10)
	4-way (1-3-5-7)	282-437/011-000 50 (5 x 10)

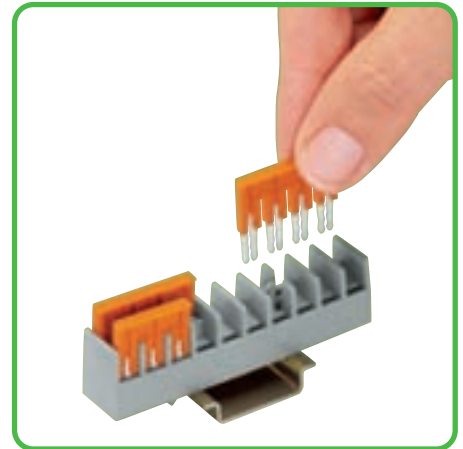

Insertion of a jumper

Transformer test circuits and complex wiring tasks...

...are no problem and only require minimum space.

Customised jumpers are available on request

Application areas:



- Power supply
- Transformer test circuits

The collective carrier can be snapped onto DIN 35 rails. It serves as a depository for jumpers, e.g. during maintenance work.

9 X-COM® SYSTEM

2-Conductor/1-Pin Receptacle Terminal Blocks

VOLUME 1

	0.08 – 4 mm² 500 V/6 kV/3 ① I_N 32 A*	AWG 28 – 12 300 V, 20 A ② 300 V, 20 A ②
	Terminal block width 5 mm / 0.197 in  8 – 9 mm / 0.33 in * ②	Terminal block width 5 mm / 0.197 in  8 – 9 mm / 0.33 in * ②



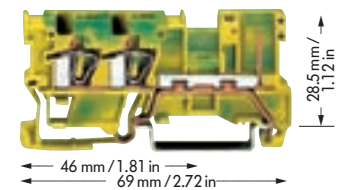
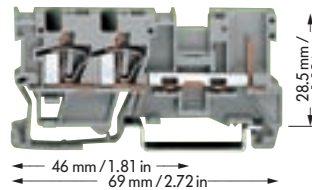







- ① 500 V = rated voltage
6 kV = rated surge voltage
3 = pollution degree
(see also Full Line Catalog W4 Volume 1, Section 15)
- ② See application notes in our Full Line Catalog W4 Volume 1, pages 2.43 – 2.45

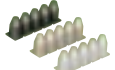

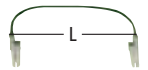
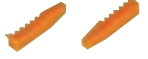
Description	Item No.	Pack. unit pcs	Item No.	Pack. unit pcs
2-conductor/1-pin receptacle terminal block, suitable for DIN 35 rail acc. to EN 50 022	2-conductor/1-pin receptacle terminal block grey	769-251 50	2-conductor/1-pin ground (earth) receptacle terminal block green-yellow	769-257 50

Accessories

appropriate marking system **Mini-WSB** (see also Full Line Catalog W4 Volume 1, Section 14)

	End and intermediate plate	1.1 mm / 0.043 in thick		1.1 mm / 0.043 in thick	
	grey	769-320	100 (4 x 25)	grey	769-320 100 (4 x 25)
	orange	769-321	100 (4 x 25)	orange	769-321 100 (4 x 25)
	Screwless end stop	6 mm / 0.236 in wide	249-116 100 (4 x 25)	6 mm / 0.236 in wide	249-116 100 (4 x 25)
		10 mm / 0.394 in wide	249-117 50 (2 x 25)	10 mm / 0.394 in wide	249-117 50 (2 x 25)
	Insulation stop ②,	0.08 – 0.2 mm ²	769-470 200 strips	0.08 – 0.2 mm ²	769-470 200 strips
	white	0.25 – 0.5 mm ²	769-471 200 strips	0.25 – 0.5 mm ²	769-471 200 strips
	5 pcs/strip	0.75 – 1 mm ²	769-472 200 strips	0.75 – 1 mm ²	769-472 200 strips
	light grey				
	dark grey				
	Adjacent jumper,	I _N 24 A	grey 280-402 200 (8 x 25)	yellow-green 280-422 200 (8 x 25)	
	insulated				
	Alternate jumper		grey 280-409 100 (4 x 25)	grey 280-409 100 (4 x 25)	
	Staggered jumper ②,	I _N 24 A	grey 780-452 100 (4 x 25)	I _N 24 A 780-452 100 (4 x 25)	
	insulated, from 1 to 2		grey 780-453 100 (4 x 25)	grey 780-453 100 (4 x 25)	
	width 5 mm / 0.197 in from 1 to 3		grey 780-454 100 (4 x 25)	grey 780-454 100 (4 x 25)	
	from 1 to 4		grey 780-455 50 (2 x 25)	grey 780-455 50 (2 x 25)	
	from 1 to 5				
	:				
	from 1 to 8		grey 780-458 50 (2 x 25)	grey 780-458 50 (2 x 25)	
	Push-in type wire jumper ②,	L = 60 mm / 2.362 in	249-125 10	L = 60 mm / 2.362 in	249-125 10
	insulated, 9 A – conductor	L = 110 mm / 4.331 in	249-126 10	L = 110 mm / 4.331 in	249-126 10
	cross section 0.75 mm ² / AWG 18	L = 250 mm / 9.843 in	249-127 10	L = 250 mm / 9.843 in	249-127 10
	Coding pin,		orange 769-435 100 (4 x 25)	orange 769-435 100 (4 x 25)	
	for coding of female plugs				
	Protective warning marker,		yellow 280-415 100 (4 x 25)		
	for 5 terminal blocks,				
	fits into screwdriver slot				
	Test plug, w. cable 500 mm / 17.7"		red 210-136 50 (5 x 10)	red 210-136 50 (5 x 10)	
	2 mm / 0.079 in Ø		yellow 210-137 50 (5 x 10)	yellow 210-137 50 (5 x 10)	
	2.3 mm / 0.091 in Ø				
	Test plug module,	Item numbers and application notes see		Item numbers and application notes see	
	for test using jumper position in	Full Line Catalog W4 Volume, pages 2.38 – 2.40		Full Line Catalog W4 Volume 1, pages 2.38 – 2.40	
	current bar or cond. wire opening				
	Test plug adapter	5 mm / 0.197 in wide	280-404 100 (4 x 25)	280-404 100 (4 x 25)	
		for test plug 210-137 (Ø 2.3 mm)		for test plug 210-137 (Ø 2.3 mm)	
	1-conductor female plug,				
	straight or angled	see Full Line Catalog W4 Volume 1, pages 9.44/9.46		see Full Line Catalog W4 Volume 1, pages 9.44/9.46	
	2-conductor female plug	see Full Line Catalog W4 Volume 1, page 9.45		see Full Line Catalog W4 Volume 1, page 9.45	

*Further approvals with corresponding ratings can be found at www.wago.com

Types of Assembly

2-Conductor/1-pin Receptacle Terminal Blocks and 1-/2-Conductor Female Plugs

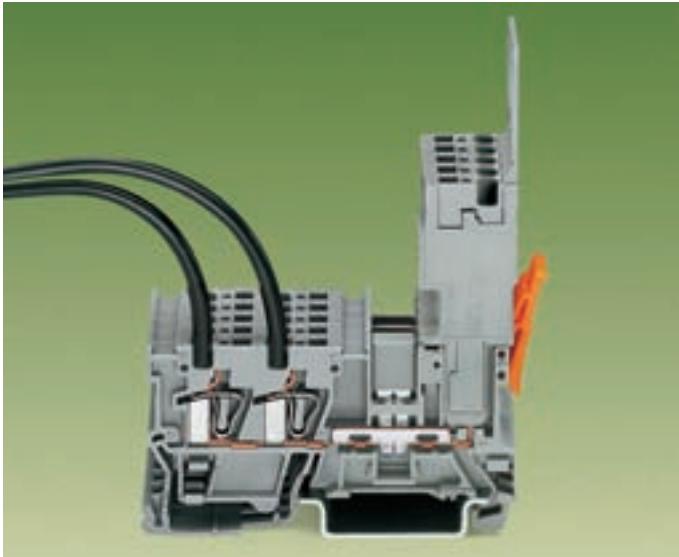

1-conductor female plug straight and angled

Commoning possibility of receptacle terminal blocks with jumper contact systems, series 280 and 780, and testing possibility with test plug adapter 280-4..

2-conductor female plug

Commoning possibility of receptacle terminal blocks only with adjacent jumpers and alternate jumpers, series 280

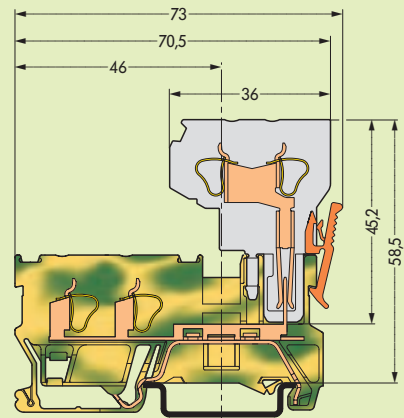

Ground (earth) receptacle terminal block

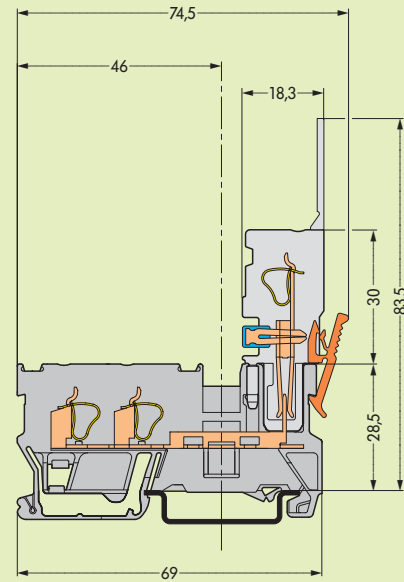

Receptacle terminal block



Operating lever, loose, for female plugs and male connectors with CAGE CLAMP® connection

Item number: 769-434

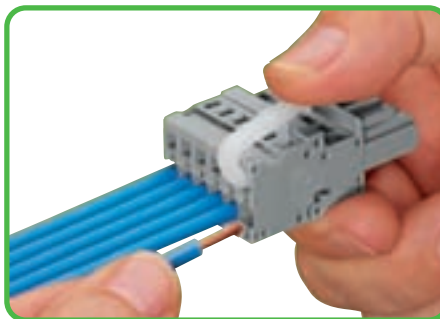

Wire connection using operating lever







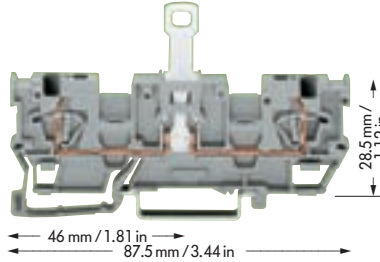

X-COM® SYSTEM

1-Conductor/1-Conductor Disconnect Receptacle Terminal Blocks with 2 Jumper Positions

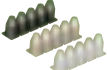
0.08 – 4 mm² | AWG 28 – 12
 400 V/6 kV/3 ① | 300 V, 10 A
 I_N 32 A
 Terminal block width 5 mm / 0.197 in
 8 – 9 mm / 0.33 in

- ① 500 V = rated voltage
 6 kV = rated surge voltage
 3 = pollution degree
 (see also Full Line Catalog W4 Volume 1, Section 15)
- ② See application notes in our Full Line Catalog W4 Volume 1, pages 2.43 – 2.45

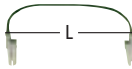

Description	Item No.	Pack. unit pcs
1-conductor/1-conductor disconnect receptacle terminal block	1-cond./1-cond. disconnect receptacle term. block	
	grey 769-242	50
without/with shield (screen) contact and 2 jumper positions,	1-cond./1-cond. disconnect receptacle term. block with shield (screen) contact (no picture)	
suitable for DIN 35 rail acc. to EN 60715	grey 769-243	50
Accessories appropriate marking system Mini-WSB (see also Full Line Catalog W4 Volume 1, Section 14)		
 End and intermediate plate	1.1 mm / 0.043 in thick grey 769-317	100 (4 x 25)
	orange 769-318	100 (4 x 25)
 Separator plate, oversized	1.1 mm / 0.043 in thick orange 769-319	100 (4 x 25)
 Screwless end stop	6 mm / 0.236 in wide 249-116	100 (4 x 25)
	10 mm / 0.394 in wide 249-117	50 (2 x 25)
 Insulation stop ②, white	0.08 – 0.2 mm ² 769-470	200 strips
5 pcs/strip light grey	0.25 – 0.5 mm ² 769-471	200 strips
dark grey	0.75 – 1 mm ² 769-472	200 strips
 Adjacent jumper, I_N 24 A insulated	grey 280-402	200 (8 x 25)
 Alternate jumper	grey 280-409	100 (4 x 25)
 Staggered jumper ②, from 1 to 2 insulated,	I _N 24 A 780-452	100 (4 x 25)
from 1 to 3	780-453	100 (4 x 25)
width 5 mm / 0.197 in from 1 to 4	780-454	100 (4 x 25)
from 1 to 5	780-455	50 (2 x 25)
:	:	:
from 1 to 8	780-458	50 (2 x 25)
 Push-in type wire jumper ②, L = 60 mm / 2.362 in 249-125	insulated, 9 A – conductor 249-126	10
	L = 110 mm / 4.331 in 249-126	10
	L = 250 mm / 9.843 in 249-127	10
 Protective warning marker, for 5 terminal blocks	yellow 280-415	100 (4 x 25)
fits into screwdriver slot,		
 Test plug, w. cable 500 mm / 17.7"		
Ø 2 mm / 0.079 in	red 210-136	50 (5 x 10)
Ø 2.3 mm / 0.091 in	yellow 210-137	50 (5 x 10)

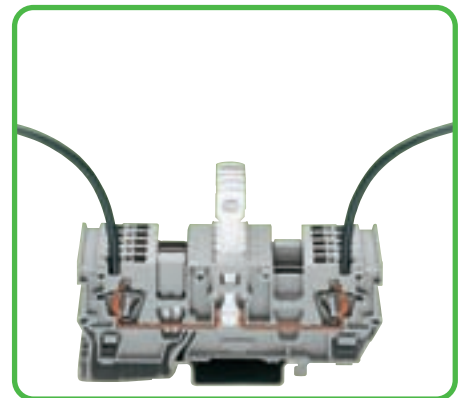
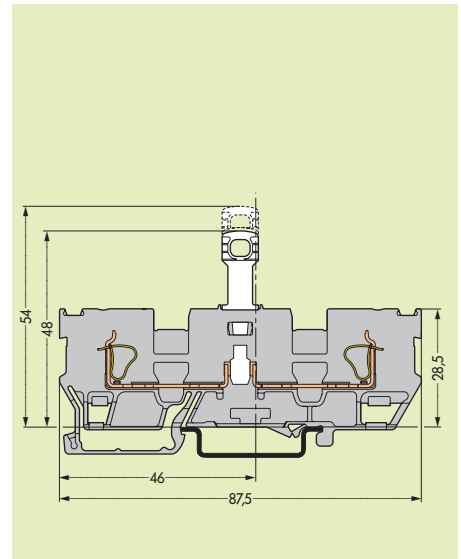

X-COM®-SYSTEM

2-Conductor/2-Pin Double Deck Receptacle Terminal Blocks

Series 870





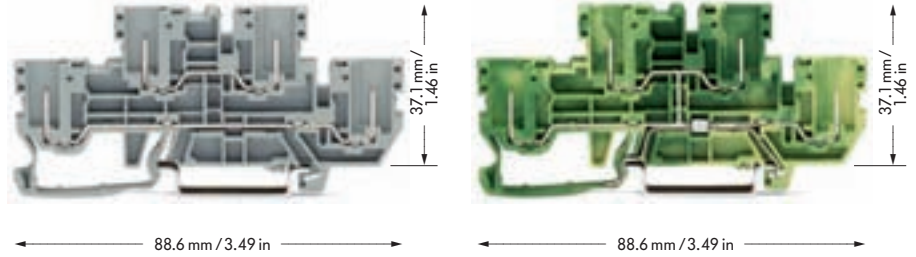

	500 V/6 kV/3 ① I_N 16 A Terminal block width 5 mm / 0.197 in	Terminal block width 5 mm / 0.197 in
--	---	---

① 500 V = rated voltage
 6 kV = rated surge voltage
 3 = pollution degree
 (see also Full Line Catalog W4
 Volume 1, Section 15)



Description	Item No.	Pack. unit pcs	Item No.	Pack. unit pcs
2-pin/2-pin double deck receptacle terminal block , suitable for DIN 35 rail	Through/through terminal blocks , housing color grey			
	L/L	870-151		50
4-pin double deck receptacle terminal block , suitable for DIN 35 rail			4-pin ground (earth) conductor terminal block , internal commoning, housing color green-yellow	
			PE	870-157
				50

Accessories appropriate marking system **WMB/Mini-WSB** (see also Full Line Catalog W4 Volume 1, Section 14)

	End and intermediate plate	1 mm/0.039 in thick		1 mm/0.039 in thick
		grey	870-168	grey 870-168
		orange	870-169	orange 870-169
			100 (4 x 25)	100 (4 x 25)
	Push-in type jumper bars , light grey, insulated, I _N 18 A	2-way	870-402	2-way 870-402
		3-way	870-403	3-way 870-403
		4-way	870-404	4-way 870-404
		5-way	870-405	5-way 870-405
		:	:	:
		10-way	870-410	10-way 870-410
			100 (4 x 25)	100 (4 x 25)
	Push-in type jumper bars , light grey, insulated, I _N 18 A	from 1 to 3	870-433	from 1 to 3 870-433
		from 1 to 4	870-434	from 1 to 4 870-434
		from 1 to 5	870-435	from 1 to 5 870-435
		:	:	:
		from 1 to 10	870-440	from 1 to 10 870-440
			100 (4 x 25)	100 (4 x 25)
	Miniature WSB quick marking card , 10 strips with 10 markers each, white with black printing	see Full Line Catalog W4 Volume 1, Section 14		see Full Line Catalog W4 Volume 1, Section 14
	1-connector female plug , straight	see Full Line Catalog W4 Volume 1, Section 9		see Full Line Catalog W4 Volume 1, Section 9
	1-connector female plug , angled	see Full Line Catalog W4 Volume 1, Section 9		see Full Line Catalog W4 Volume 1, Section 9

X-COM®-SYSTEM Blue Components

0.08 – 4 mm² | AWG 28 – 12
500 V/6 kV/3 ① | 300/600 V, 10/5 A ②
I_N 32 A**

Module width 5 mm / 0.197 in
8 – 9 mm / 0.33 in

0.08 – 4 mm² | AWG 28 – 12
500 V/6 kV/3 ① | I_N 32 A**

Module width 5 mm / 0.197 in
8 – 9 mm / 0.33 in

0.08 – 4 mm² | AWG 28 – 12
500 V/6 kV/3 ① | I_N 32 A**

Terminal block width 5 mm / 0.197 in
8 – 9 mm / 0.33 in

* ① ②



No. of poles	Item No.	Pack. unit pcs	No. of poles	Item No.	Pack. unit pcs	No. of poles	Item No.	Pack. unit pcs
1-conductor female plugs, with coding fingers, blue, commoning possibility with miniature adjacent jumpers			1-conductor female plug, with coding fingers, grey, blue, green-yellow, commoning possibility with miniature adjacent jumpers			1-conductor female plug, with coding fingers, grey, blue, green-yellow, commoning possibility with miniature adjacent jumpers		
1 pole	769-101/000-006	200	3 poles	769-103/000-038	50	5 poles	769-105/000-038	50
2 poles	769-102/000-006	100						
3 poles	769-103/000-006	50	1-conductor female plug, with coding fingers, green-yellow, blue, grey, commoning possibility with miniature adjacent jumpers			1-conductor female plug, with coding fingers, green-yellow, blue, grey, commoning possibility with miniature adjacent jumpers		
4 poles	769-104/000-006	50	3 poles	769-103/000-039	50	5 poles	769-105/000-039	50
5 poles	769-105/000-006	50						
6 poles	769-106/000-006	50						
7 poles	769-107/000-006	50						
8 poles	769-108/000-006	50						
9 poles	769-109/000-006	50						
10 poles	769-110/000-006	50						
11 poles	769-111/000-006	50						
12 poles	769-112/000-006	50						
13 poles	769-113/000-006	50						
14 poles	769-114/000-006	50						
15 poles	769-115/000-006	50						
<p>① 500 V = rated voltage 6 kV = rated surge voltage 3 = pollution degree</p>								



Miniature adjacent jumper,







insulated, I_N 24 A, grey, suitable for 1-conductor female plugs
769-402 100 (4 x 25)

* Further approvals with corresponding ratings can be found at www.wago.com
** Current-carrying capacity curves and accessories see Full Line Catalog W4 Volume 1, Section 9

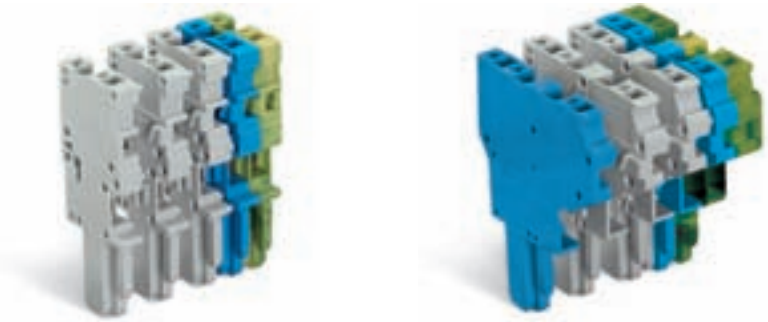
X-COM®-SYSTEM Female Plugs for Self-Assembly

	<p>0.08 – 4 mm² AWG 28 – 12 500 V/6 kV/3 ① I_N 32 A**</p> <p>Module width 5 mm / 0.197 in  8 – 9 mm / 0.33 in</p>	<p>0.08 – 4 mm² AWG 28 – 12 500 V/6 kV/3 ① I_N 32 A**</p> <p>Module width 5 mm / 0.197 in  8 – 9 mm / 0.33 in</p>
--	--	--

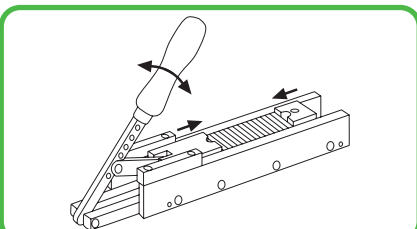

	Color	Item No.	Pack.-unit pcs	Color	Item No.	Pack.-unit pcs
	1-conductor base module with integrated end plate			2-conductor base module with integrated end plate		
	grey	769-501	250	grey	769-504	250
	blue	769-501/000-006	250	blue	769-504/000-006	250
	green-yellow	769-501/000-016	250	green-yellow	769-504/000-016	250
	1-conductor center module			2-conductor center module		
	grey	769-502	250	grey	769-505	250
	blue	769-502/000-006	250	blue	769-505/000-006	250
	green-yellow	769-502/000-016	250	green-yellow	769-505/000-016	250
	1-conductor end module			2-conductor end module		
	grey	769-503	250	grey	769-506	250
	blue	769-503/000-006	250	blue	769-506/000-006	250
	green-yellow	769-503/000-016	250	green-yellow	769-506/000-016	250
	Mounting tool			Mounting tool		
		298-646	1		298-641	1
① 500 V = rated voltage 6 kV = rated surge voltage 3 = pollution degree						

** Current-carrying capacity curves and accessories see Full Line Catalog W4 Volume 1, Section 9

0.08 – 4 mm ² 500 V/6 kV/3 ① I _N 32 A** Module width 5 mm / 0.197 in  8 – 9 mm / 0.33 in	AWG 28 – 12
---	-------------



Color	Item No.	Pack.-unit pcs
1-conductor base module, 45° angled, with integrated end plate		
grey	769-512	250
blue	769-512/000-006	250
green-yellow	769-512/000-016	250
1-conductor end module, 45° angled		
grey	769-513	250
blue	769-513/000-006	250
green-yellow	769-513/000-016	250
1-conductor end module, 45° angled		
grey	769-515	250
blue	769-515/000-006	250
green-yellow	769-515/000-016	250
Mounting tool		
	298-642	1

Self-assembly of individual female plugs

Using modular female plugs from the X-COM-SYSTEM, female plugs can be customized for applications requiring varying numbers of poles (e.g. when designing prototypes).

Modules and pole numbers

A self assembled female plug consists of a base module with integrated end plate, up to 13 center modules (corresponding to a 15-pole female plug = maximum number of poles) as well as an end module.

Female plugs with ground (earth) modules (green-yellow)

According to the "norm", connectors should be inserted and disengaged off load. This is why pre-mating the ground (earth) contact is required when connectors need to be connected or disengaged "under load".

This is guaranteed using a ground (earth) module in the middle of female plugs equipped with up to 7 poles or two ground (earth) modules at both ends of 8 - 15 pole female plugs to ensure a preceding ground (earth) connection.

Mounting

In order to guarantee that the individual modules are properly snapped into each other without damaging the locking latches, it is necessary to use the appropriate mounting tool.

Example of a 5-pole 1-conductor female plug

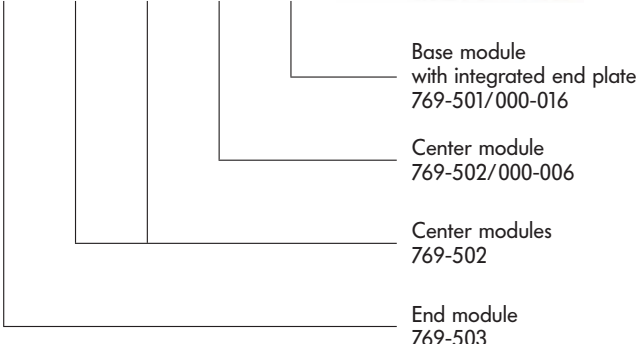



10 Compact Connector for Flexible Conductors Series 222

VOLUME 1

2 x 0.08 – 2.5 mm² "s+f-st"
 4 mm² "f-st"
 400 V/4 kV/2**
 I_N 32 A
 9 – 10 mm / 0.37 in

AWG 28 – 12
 600 V, 20 A 

5 x 0.08 – 2.5 mm² "s+f-st"
 4 mm² "f-st"
 400 V/4 kV/2**
 I_N 32 A
 9 – 10 mm / 0.37 in

AWG 28 – 12
 600 V, 20 A 

* 

*  ENEC



Item No.	Pack.-unit pcs	Item No.	Pack.-unit pcs
Compact connector, 2-wire connector, with levers max. continuous service temperature 85°C grey	222-412	Compact connector, 5-wire connector, with levers max. continuous service temperature 85°C grey	222-415 400 (10 x 40)

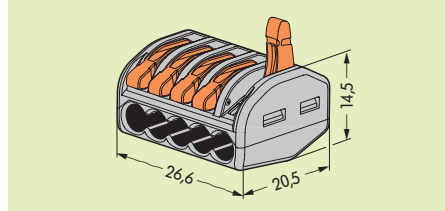
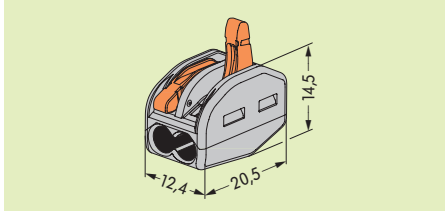

Compact connector

It clamps up to 5 stripped flexible wires of 0.08 mm²/AWG 28 to 4 mm²/AWG 12 or solid or stranded wires up to 2.5 mm²/AWG 14, without tools.

This is how it works:

Open the clamping point using one of the small orange colored levers so that the lever engages and keeps the clamping point in its open position. The wire can now be inserted, then the lever can be returned to its rest position, flush with the terminal block housing.

The safety:

The special rest position of the lever reliably prevents accidental unclamping of a connected wire. The additional application safety for any type of conductor (solid, stranded, flexible) is confirmed by approbations like ENEC or UL.



The ENEC mark is a European safety mark including 20 countries.

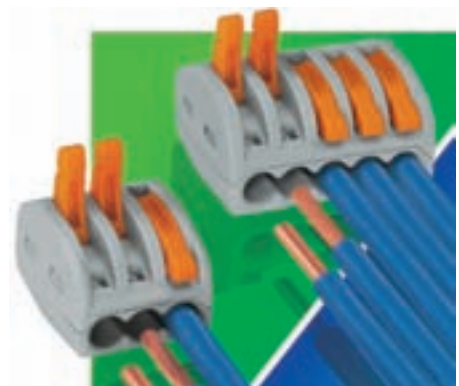

* You can find approvals on the Internet at www.wago.com.
 ** in grounded (earthed) supply systems

Mounting Carrier and Push-Wire Connectors for Junction Boxes Series 773

PUSH WIRE®

<p>4 x 0.75 – 2.5 mm² "s" 4 x 1.5 – 2.5 mm² "str." 400 V / 4 kV / 2** I_N 24 A</p> <p>12 mm / 0.47 in</p>	<p>4 x AWG 18 – 12 "sol." 4 x AWG 16 – 12 "str." 600 V, 20 A</p>	<p>3 x 2.5 – 6 mm² "s" 400 V / 4 kV / 2** I_N 41 A</p> <p>12 – 13 mm / 0.53 in</p>	<p>AWG 14 – 10 "sol." 600 V, 30 A</p>	<p>Mounting carrier for push-wire connectors for junction boxes Series 773</p> <p>Adapter width 18 mm / 0.71 in</p>
---	--	---	---	---

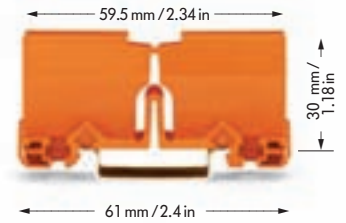

Item No.	Pack.-unit pcs	Item No.	Pack.-unit pcs	Item No.	Pack.-unit pcs
Push-wire connector for junction boxes, 3-wire connector, black, max. continuous service temperature 150 °C		Push-wire connectors for junction boxes, 3-wire connector, color of housing transparent, color of cover red		Mounting carrier orange	
773-514	1000 (10 x 100)	773-173	500 (10 x 50)	773-332	50 (5 x 10)
				Marker strips, plain	
				210-334	1 card

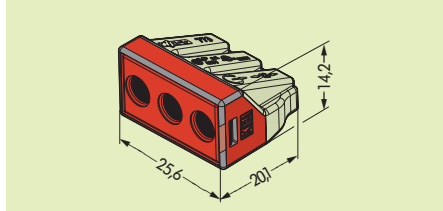
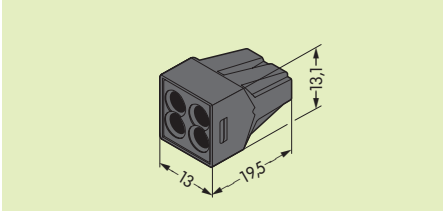

For time and cost saving push-in wiring up to 6 mm² in distribution and junction boxes as well as other equipment.

As an addition to the 273 Series push wire connectors for AWG 16 to AWG 12 (1.5 – 4 mm²), the new 3-conductor push wire connector expands the range of wire sizes up to AWG 10 (6 mm²) and is suitable for both solid and fine-stranded wires.

A mounting carrier (see accessories) is suitable for applications where the connectors must be marked and fixed in position. The carrier fits up to two connectors on DIN 35 carrier rails or screw mounting on level surfaces.

Using this push wire connector, a large range of wiring applications can be realized in distribution or junction boxes, for example. To mention just a few: potential multiplication of an AWG 10 (6 mm²) conductor in a junction box, changing from or to AWG 10 (6 mm²) wire size.



Shield (Screen) Clamps, Carrier with Grounding Foot Series 790, 791

<p>Shield (Screen) Clamps</p> <p>Note: Cannot be used for the connection of ground (earth) conductors!</p>	<p>Carrier with grounding foot</p>	<p>Carrier with grounding foot</p>
--	---	---



Shield (screen) clamps			Pack.-unit pcs	Carrier w. grounding foot, for DIN 35 rail, bar parallel to the rail, 10 mm (0.394 in) x 3 mm (0.118 in), bar a. foot – Cu with tin plating	Pack.-unit pcs	Carrier w. grounding foot, for DIN 35 rail, bar parallel to the rail, 10 mm (0.394 in) x 3 mm (0.118 in), bar a. foot – Cu with tin plating	Pack.-unit pcs		
H _{max}	B	Diameter of connectable conductor							
40 mm	10 mm	1.5 mm to 6.5 mm	791-107	15 mm long/0.59 in	790-110	25	45 mm long/1.772 in	790-114	25
47 mm	17 mm	5 mm to 11 mm	791-111						
63 mm	23 mm	10 mm to 17 mm	791-117						
78 mm	30 mm	16 mm to 24 mm	791-124						
				25 mm long/0.98 in	790-112	25			

Dimensions (in mm), Application notes

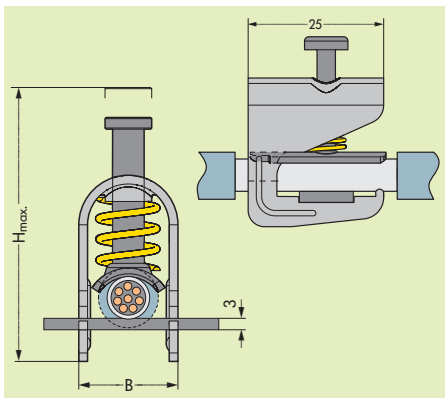

Item No.	Length	suitable shield (screen) clamping saddle	
		790-	791-
790-110	15 mm / 0.59 in	max. 790-108	–
790-112	25 mm / 0.98 in	max. 790-116	791-111, 791-117
790-114	45 mm / 1.772 in	790-108 to 790-140	791-111 to 791-124
		see Full Line Catalog W4 Volume 1, Section 12	

Busbar Carrier	Busbar Carrier	Shield termination
----------------	----------------	--------------------



Item No.	Pack.-unit pcs	Item No.	Pack.-unit pcs	Item No.	Pack.-unit pcs
Busbar Carrier		Busbar Carrier		Shield termination	
for busbars Cu 10 mm x 3 mm		for busbars Cu 10 mm x 3 mm		including cable tie	
				for shield diameter	
790-300		790-301		5 mm / 0.197 in to 10 mm / 0.394 in	
				55 mm / 2.17 in long 709-350 100 (4 x 25)	
				150 mm / 5.9 in long 709-352 100 (4 x 25)	



Remove the busbar carrier using a screwdriver (blade width 5.5 mm / 0.217 in)



To remove the busbar, compress the spring using pliers



Dimensions (in mm)

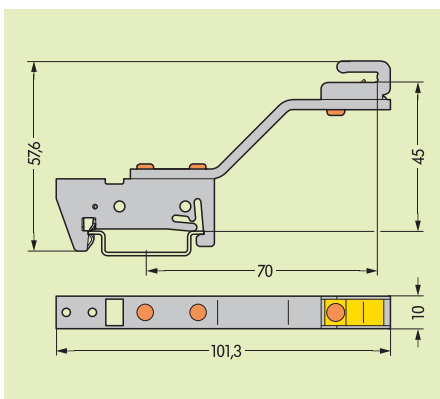
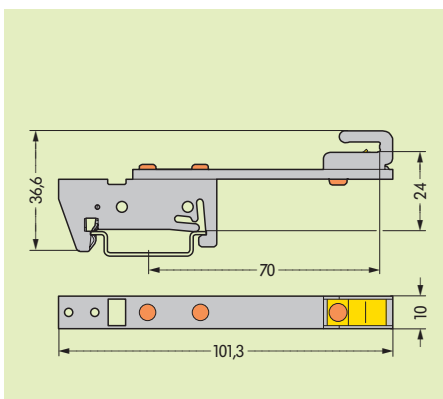

14 WAGO Wire and Cable Marking . . .

Wire marking

VOLUME 1



The following marker cards are available:
Marker cards for plotter marking ...



... or marker cards on roll
for thermal transfer printing



Remove the thermal transfer printed marker card
from the roll ...



Slide the plotted marker card into the marking
sleeve receptacle. Changing the marking is also
possible after the wire has been connected

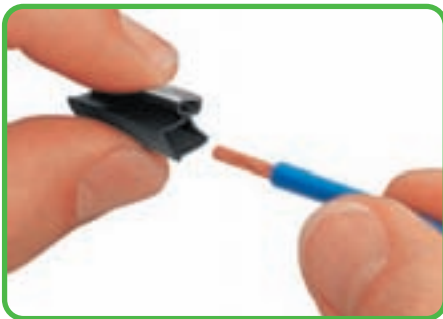

Compress the sleeve and slide it onto the wire to
be marked

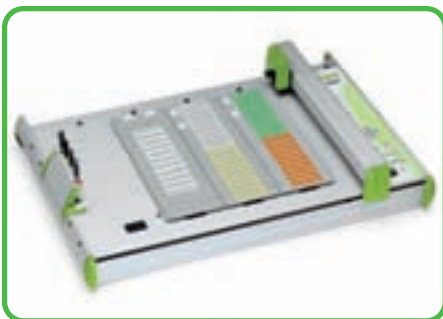
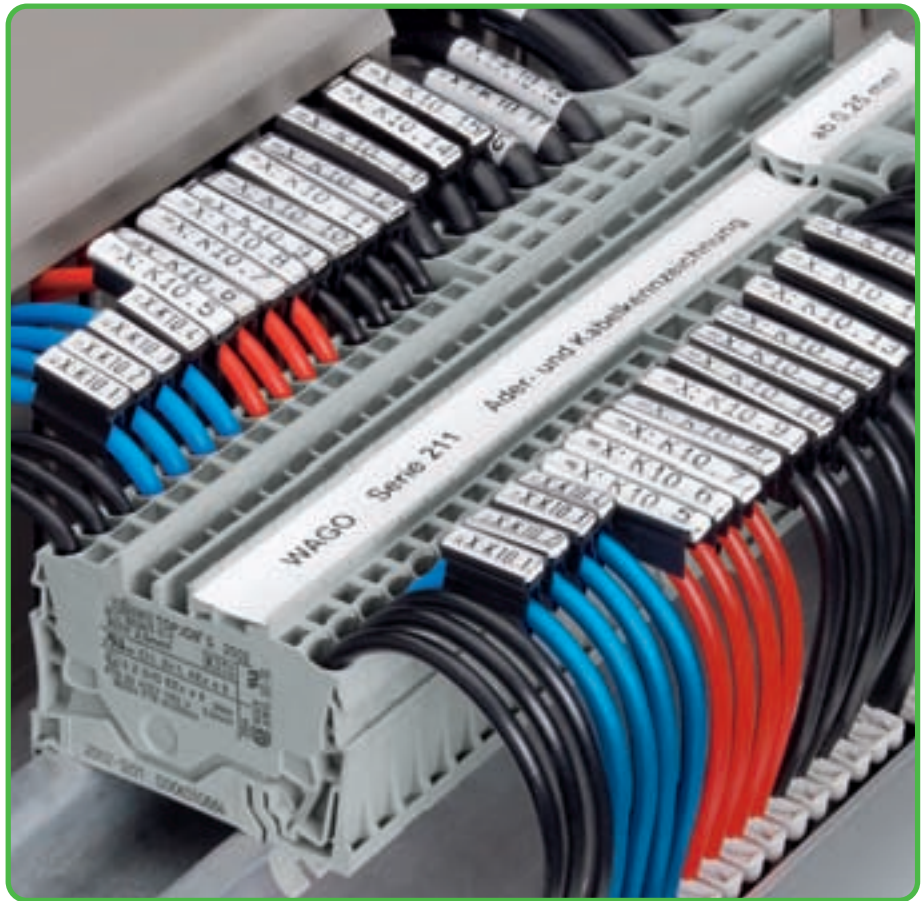

Plotter IP 350

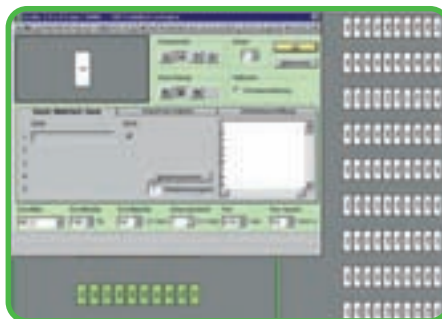

WAGO smart Marking software (see also Full Line
Catalog W4 Volume 1, Section 14)



Thermal transfer printer TP 298

... Description and Handling



... and slide it through the marker receptacle up to the end of the sleeve ...



... then remove the rest of the card by twisting it off



Fix the marking sleeve 211-129 using cable ties to individual wire or cable



Cable marking



Self-laminating labels (are) available on A4 sheets for the laser printer (plotter) ...



... or are supplied on roll for the thermal transfer printer



Remove the printed label from the sheet or roll ...



... and wrap it around the wire or cable

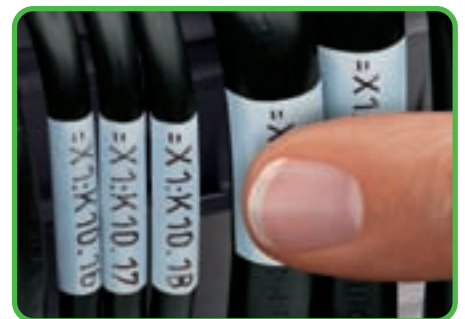

The transparent laminate protects the marking

Wire Marking for Wire Sizes from AWG 24 to 4 (0.25 mm² to 16 mm²)

Wire marking sleeve, halogen-free
for marker card, for wires ranging
from AWG 24 to 4 (0.25mm² to 16 mm²)
(to be fitted before wire connection)

Wire marking sleeve, halogen-free
for marker card, for wires ranging
from AWG 24 to 4 (0.25mm² to 16 mm²)
(to be fitted before wire connection)







Item No.	Pack.-unit pcs	Item No.	Pack.-unit pcs
Marking sleeve 12 mm long /0.472 in		Marking sleeve 23 mm long /0.9 in	
for wire Ø 1.6 – 3.2 mm or AWG 24 – 16 (0.25 mm ² – 1.5 mm ²)		for wire Ø 1.6 – 3.2 mm or AWG 24 – 16 (0.25 mm ² – 1.5 mm ²)	
211-112	2000	211-122	2000
for wire Ø 2.2 – 4.5 mm or AWG 20 – 12 (0.5 mm ² – 4 mm ²)		for wire Ø 2.2 – 4.5 mm or AWG 20 – 12 (0.5 mm ² – 4 mm ²)	
211-113	2000	211-123	2000
for wire Ø 3.7 – 5.9 mm or AWG 14 – 10 (2.5 mm ² – 6 mm ²)		for wire Ø 3.7 – 5.9 mm or AWG 14 – 10 (2.5 mm ² – 6 mm ²)	
211-114	1000	211-124	1000
for wire Ø 4.8 – 7.5 mm or AWG 10 – 4 (6 mm ² – 16 mm ²)		for wire Ø 4.8 – 7.5 mm or AWG 10 – 4 (6 mm ² – 16 mm ²)	
211-115	1000	211-125	1000
Article specific accessories		Article specific accessories	
Marker card , for thermal transfer printer,  12 mm long /0.472 in, white 211-111 1 x 3000		Marker card , for thermal transfer printer,  23 mm long /0.9 in, white 211-121 1 x 3000	
Marker card , for plotter,  12 mm long /0.472 in, white 211-110 18 x 57		Marker card , for plotter,  23 mm long /0.9 in, white 211-120 30 x 34	
Plotter receptacle , for marker card  258-370 1		Plotter receptacle , for marker card  258-370 1	
Accessories (see also Full Line Catalog W4 Volume 1, Section 14)			
Thermal transfer printer, TP 298  Resolution 300 dpi 258-298 1		Plotter IP 350  258-350 1	
Thermal transfer printer, TP 297  Resolution 203 dpi 258-297 1		WAGO plotter pen , line width 0.35 mm  258-228 1	
Ink ribbon , 90 mm /3.54 in width, 300 m roll  258-150 1		WAGO disposable pen , line width 0.35 mm  258-328 1	

Cable Marking

<p>Cable marking sleeve, halogen-free for marker card, for wire sizes from AWG 8 (10 mm²) for cable tie (can also be fitted subsequently)</p>	<p>Self-laminating labels on DIN A4 sheets or roll for cable marking.</p> <p>Cable diameter approx. 3 mm/0.118 in – 14 mm/0.55 in</p>
---	---



Item No.	Pack.-unit pcs	Item No.	Pack.-unit pcs
Marking sleeve, for cable tie 23 mm long /0.9 in		Labels on DIN A4 sheets for laser printer	
for wires from AWG 8 (10 mm ²)		Marker surface "S" = 9 mm x "B" = 17 mm "L" = 35 mm for max. cable Ø 8 mm /0.315 in 70 labels per sheet	
211-129	1000	211-150	20
		Marker surface "S" = 13 mm x "B" = 21 mm "L" = 56 mm for max. cable Ø 14 mm /0.55 in 32 labels per sheet	
		211-151	25
Article specific accessories		Labels on roll for thermal transfer printer	
Marker card, for thermal transfer printer, 23 mm /0.9 in long, white		Marker surface "S" = 8 mm x "B" = 18 mm "L" = 35 mm for max. cable Ø 9 mm /0.354 in 9,000 labels per roll	
	211-121 1 x 3000	211-155	1
Marker card, for plotter, 23 mm /0.9 in long, white		Marker surface "S" = 13 mm x "B" = 23 mm "L" = 51 mm for max. cable Ø 12 mm /0.472 in 5,000 labels per roll	
	211-120 30 x 34	211-156	1
Plotter receptacle, for marker card			
	258-370 1		
Cable tie, (2,5 x 100) mm			
	807-0090/0101-0100 25		

Accessories (see also Full Line Catalog W4 Volume 1, Section 14)

<p>Thermal transfer printer, TP 298 Resolution 300 dpi 258-298 1</p>	<p>Plotter IP 350 258-350 1</p>
<p>Thermal transfer printer, TP 297 Resolution 203 dpi 258-297 1</p>	<p>WAGO plotter pen, line width 0.35 mm 258-228 1</p>
<p>Ink ribbon 90 mm /3.54 in width, 300 m roll 258-150 1</p>	<p>WAGO disposable pen, line width 0.35 mm 258-328 1</p>

Dimensions of self-laminating label (in mm)

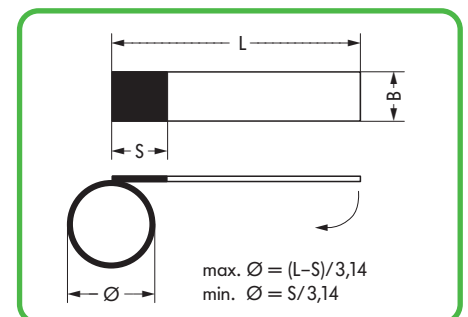

Marker carriers for WCB Combi Marking System

Marker carriers for 4 WCB markers	WCB Combi marking system	
	20 markers with identical numbers/letters each tag	

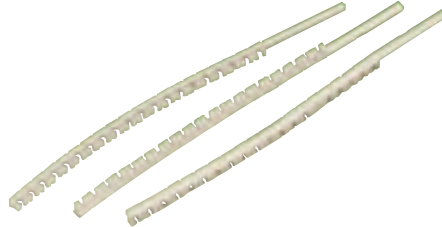

Item No.	Pack.-unit pcs	Marking per tag	Item No.	Marking per tag	Item No.
Marker carriers for 4 WCB markers 2009-184			plain	249-200	A (20x) 249-211
		1 (20x)	249-201	B (20x)	249-212
		2 (20x)	249-202	C (20x)	249-213
suitable for terminal blocks with WMB marking receptacle			3 (20x)	249-203	D (20x) 249-214
		4 (20x)	249-204	E (20x)	249-215
		5 (20x)	249-205	F (20x)	249-216
		6 (20x)	249-206	G (20x)	249-217
		7 (20x)	249-207	H (20x)	249-218
		8 (20x)	249-208	I (20x)	249-219
		9 (20x)	249-209	J (20x)	249-220
		0 (20x)	249-210	K (20x)	249-221
				L (20x)	249-222
		1 . . . 0 (2x)	249-239	M (20x)	249-223
				N (20x)	249-224
		1. (20x)	249-241	O (20x)	249-225
		2. (20x)	249-242	P (20x)	249-226
		3. (20x)	249-243	Q (20x)	249-227
		4. (20x)	249-244	R (20x)	249-228
		5. (20x)	249-245	S (20x)	249-229
		6. (20x)	249-246	T (20x)	249-230
		7. (20x)	249-247	U (20x)	249-231
		8. (20x)	249-248	V (20x)	249-232
		9. (20x)	249-249	W (20x)	249-233
		0. (20x)	249-250	X (20x)	249-234
				Y (20x)	249-235
		+	249-237	Z (20x)	249-236
		-	249-238		
Pieces per packing unit: 10 tags					



Insert WCB Combi marker into marker carrier



Twist the marker carrier off the carrier holder . . .



. . . and insert the marker carrier into the WMB marking receptacle of the terminal block

Contents

Volume 2



Terminal strips for PCBs – **Reflow**
 Pin spacing 2.5 mm/0.098 in
 Pin spacing 2.54 mm/0.1 in

Series 218 54
 Series 218 54

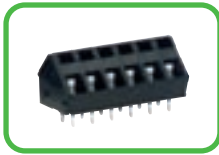

Terminal strips for PCBs – **Reflow**
 Pin spacing 5 mm/0.197 in
 Pin spacing 2.5 mm/0.098 in
 Pin spacing 3.5 mm/0.138 in

Series 236 55
 Series 250 55
 Series 250 55



Terminal strips with “internal commoning”
 Pin spacings 5 mm/0.197 in,
 7.5 mm/0.295 in; 2.5 mm²/AWG 14

Series 804 57

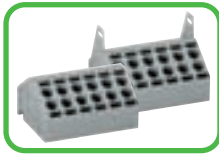

2-conductor female connector strips
 with CAGE CLAMP[®]S connection
 1.5 mm²/AWG 16

Series 806 58



2-conductor modular terminal blocks and terminal strips
 with CAGE CLAMP[®]S connection
 Pin spacing 75 mm/0.295 in;
 6 (10) mm²/AWG 10

Series 746 59

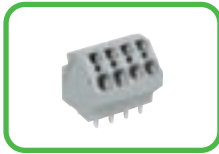

Modular terminal blocks and terminal strips without jumper slot
 with CAGE CLAMP[®] connection
 Pin spacing 5 mm/0.197 in; 4 mm²/AWG 12
 Pin spacing 7.5 mm/0.295 in; 4 mm²/AWG 12
 Pin spacing 10 mm/0.394 in; 4 mm²/AWG 12
 Pin spacing 12.5 mm/0.492 in; 4 mm²/AWG 12

Series 745 60
 Series 745 60 – 61
 Series 745 60 – 61
 Series 745 60 – 61

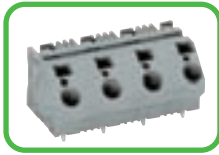

Modular terminal blocks with spacers 6 mm²
 Pin spacing 7.5 mm/0.295 in, 10 mm/0.394 in
 Terminal strips with spacers 6 mm²/AWG 10
 Pin spacing 10 mm/0.394 in,
 12.5 mm/0.492 in, 15 mm/0.591 in

Series 745 62
 Series 745 63

MULTI CONNECTION SYSTEM



Male and female connectors
 with CAGE CLAMP[®] connection
 Pin spacing 2.5 mm/0.098 in

Series 733 64

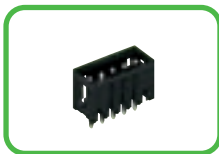

Headers with solder pins – **Reflow**
 Pin spacing 3.5 mm/0.138 in

Series 734 66 – 67

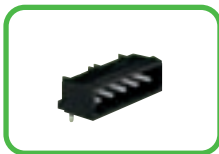





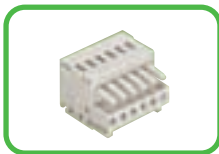
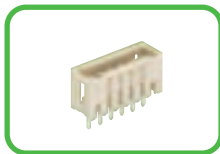

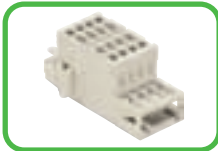

Headers with solder pins – **Reflow**
 Pin spacing 5 mm/0.197 in

Series 231 68 – 69

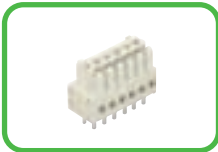

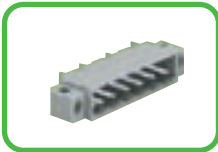
Extension of pole number - connectors,
 Pin spacing 3.5 mm/0.138 in

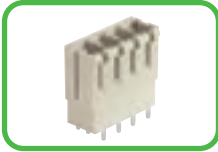
Series 734 70

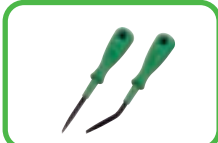
	Combi strip with CAGE CLAMP® connection Pin spacing 3.5 mm/0.138 in	Series 734	71
	IP 20 protection using cover for male connectors Pin spacings 3.5 mm/0.138 in, 3.81 mm/0.15 in	Series 734	72
	Operating tools <i>MINI</i> <i>MIDI</i>	Series 734 Series 231	73 73
	Female connectors with solder pins Pin spacing 3.5 mm/0.138 in Pin spacing 3.81 mm/0.15 in	Series 734 Series 734	74 75
	Angled female connectors with CAGE CLAMP® connection Pin spacing 5 mm/0.197 in	Series 722	76
	Extension of pole number Pluggable connectors with right angle solder pins, Pin spacing 5 mm/0.197 in Pluggable connectors with threaded/screw flanges, Pin spacing 5.08 mm/0.2 in	Series 231 Series 231	77 79
	Comb type jumper bars Pin spacing 5 mm/0.197 in	Series 231	78
	Strain relief plates for 2-conductor female connectors with CAGE CLAMP® connection	Series 734	80
	Headers with solder pins Pin spacing 7.62 mm/0.3 in	Series 831	81
	Headers with CAGE CLAMP® connection Pin spacing 7.62 mm/0.3 in	Series 831	82
	Female connectors with CAGE CLAMP® connection and locking device Pin spacing 7.62 mm/0.3 in	Series 831	83
	Operating tools Screw driver	Series 210	84

PCB Terminal Strips for THR Soldering Series 236 and Series 250

CAGE CLAMP®

VOLUME 2

<p>Pin spacing 5 / 0.197 in 0.08 – 2.5 mm² AWG 28 – 12** 200 V/4 kV/3, I_N 16 A 300 V, 15 A </p> <p> 5 – 6 mm / 0.22 in</p> <p>* </p>	<p>Pin spacing 2.5 mm / 0.098 in 0.4 – 0.8 mm Ø "s" AWG 26 – 20 "sol." 250 V/2.5 kV/2 300 V, 5 A </p> <p>I_N 2 A</p> <p> 8.5 – 9.5 mm / 0.35 in</p> <p>* </p>	<p>Pin spacing 3.5 mm / 0.138 in 0.5 – 1.5 mm² "s+f-st" AWG 20 – 16 "sol." 400 V/4 kV/2 300 V, 5 A </p> <p>I_N 2 A</p> <p> 8.5 – 9.5 mm / 0.35 in</p> <p>* </p>
---	---	---



No. of poles	Item No.	Pack. unit pcs	No. of poles	Item No.	Pack. unit pcs	No. of poles	Item No.	Pack. unit pcs
Terminal strips, reflow soldering technology, 2 solder pins / pole, black			Terminal strips with push-button, reflow soldering technology, 1 solder pin/pole staggered, black, with test slot for test pin up to 1.3 mm Ø			Terminal strips with push-button, reflow soldering technology, 1 solder pin/pole staggered, black, with test slot for test pin up to 1.3 mm Ø		
2	236-402/334-604	420 (4x 105)	2	250-402/350-604	720 (4x 180)	2	250-202/350-604	560 (4x 140)
3	236-403/334-604	280 (4x 70)	3	250-403/350-604	520 (4x 130)	3	250-203/350-604	400 (4x 100)
4	236-404/334-604	220 (4x 55)	4	250-404/350-604	400 (4x 100)	4	250-204/350-604	300 (4x 75)
5	236-405/334-604	160 (4x 40)	5	250-405/350-604	340 (4x 85)	5	250-205/350-604	240 (4x 60)
6	236-406/334-604	140 (4x 35)	6	250-406/350-604	280 (4x 70)	6	250-206/350-604	200 (4x 50)
			7	250-407/350-604	240 (4x 60)	7	250-207/350-604	180 (4x 45)
			8	250-408/350-604	220 (4x 55)	8	250-208/350-604	160 (4x 40)
Other numbers of poles and pin spacings on request			Other numbers of poles and pin spacings on request			Other numbers of poles and pin spacings on request		

Accessories

	Operating tools ①,			Test pin, Ø 1 mm/0.039 in		Test pin, Ø 1 mm/0.039 in
	Plastic	236-332 1		735-500 1		735-500 1
	Metal	236-335 1		Test wire for sold. onto test plug		Test wire for sold. onto test plug

Double savings are now available with WAGO PCB terminal blocks: as always, the time-saving CAGE CLAMP® and push-wire connections and now additional savings from their suitability for the THR solder process. This is achieved by changing the length of the solder pin which is adapted to the reflow process and by the use of high temperature resistant plastic for the insulating housing.

The new terminal blocks are simply pushed into the solder paste filled PCB holes and then soldered along with the SMT components. The previous wave soldering process is no longer necessary. The result is a perfect connection both from the mechanical and the electrical point of view.

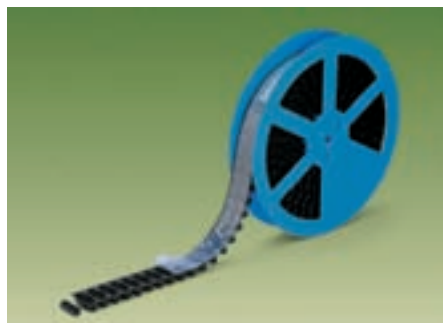

Packings for pick and place applications on request



Dimensions (in mm)

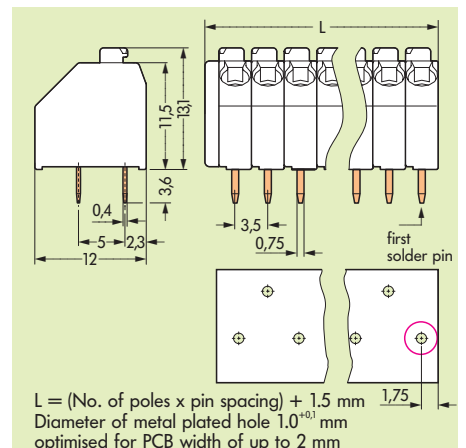
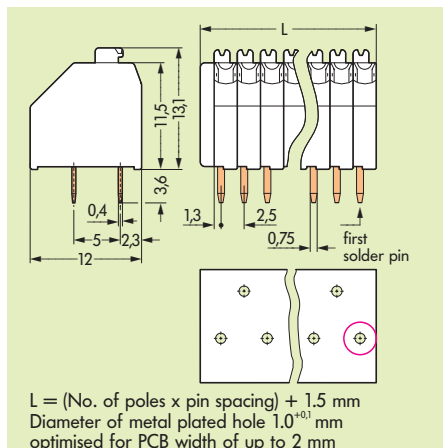
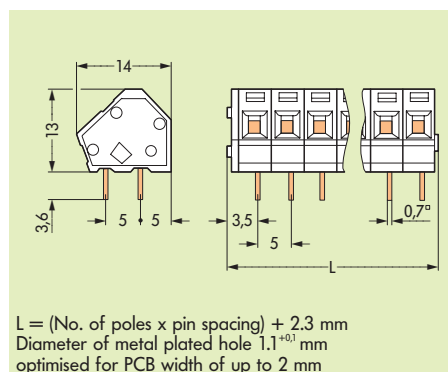

** AWG 12: THHN, THWN ① for factory wiring

1 Reflow Soldering

VOLUME 2

THR (Through-Hole-Reflow)

Design and application recommendations for the THR solder process

The THR preparation and solder process

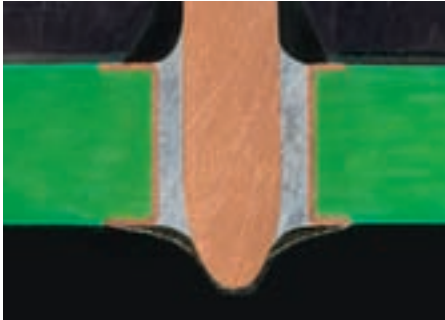

In the manufacture of electronic products, **Surface Mount Technology** has led to a rapid rise in productivity.

The integration of classic electromechanical components such as connectors or PCB terminal blocks into the reflow soldering process offers even more potential for economy.

By using high temperature resistant plastic and an optimized pin design, the **WAGO Through Hole Reflow PCB terminal blocks** meet the requirement for SMT process capability while maintaining the necessary stability.

THR product series

Series	d_i (mm)	d_A (mm)	H(mm)	d_s (mm)	D_s (μ m)	d(mm)	L(mm)
734	$1.4^{+0.1}$	2.5	< 2	2.4	150	1.2	2.4
231	$1.4^{+0.1}$	2.5	< 2	2.4	150	1.2	2.4
236	$1.1^{+0.1}$	2.2	< 2	2.1	150	0.9	3.6
250	$1.0^{+0.1}$	2.0	< 2	2.1	150	0.9	3.6

- d_i : Inner diameter metal plated PCB bore hole
- d_A : Outer diameter metal plated PCB bore hole*
- H: PCB thickness
- d_s : Pattern hole diameter
- D_s : Pattern thickness
- d: Pin diagonal
- L: Pin length

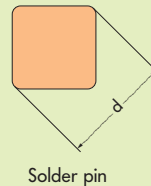

* When laying out the metal plated bore holes, consider the requirements of air and creepage distances of the equipment standards.

We recommend a temperature profile in accordance with EN 61760-1 and the use of forced convection ovens.

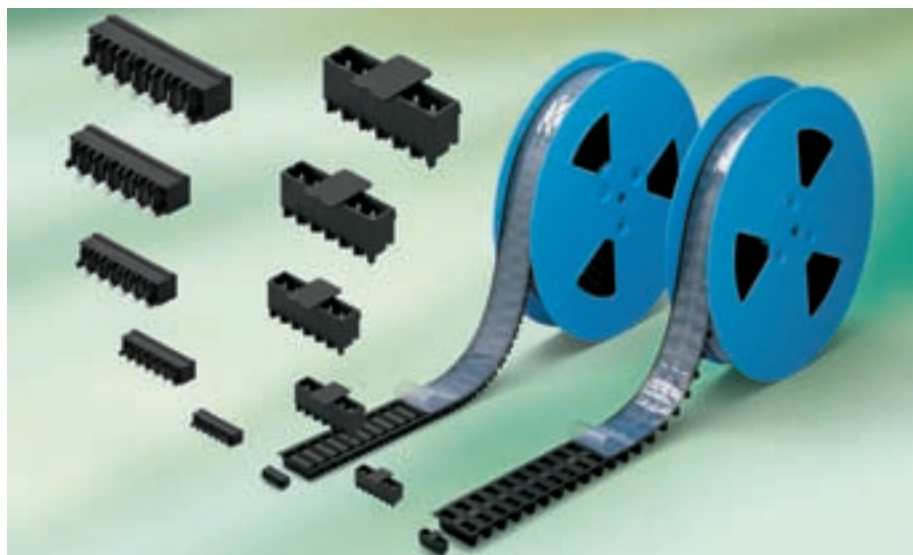

"Tape on Reel" packings for pick and place applications

Metal plated PCB bore hole

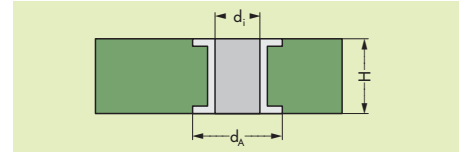

SMD positioning pattern

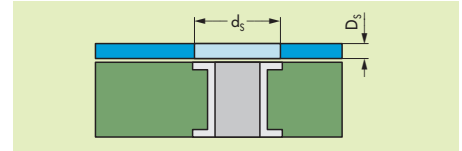

Application of solder paste

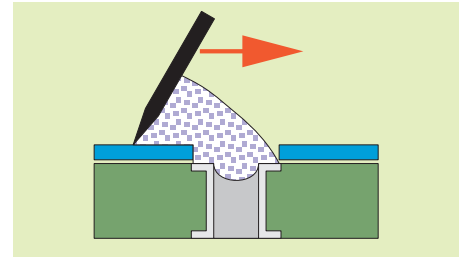

Component assembly automatic / by hand

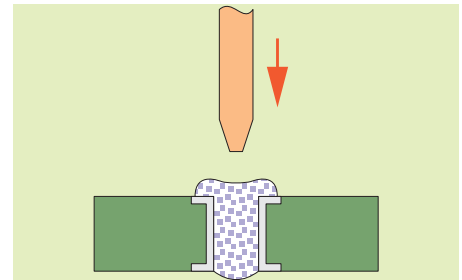

Reflow soldering process

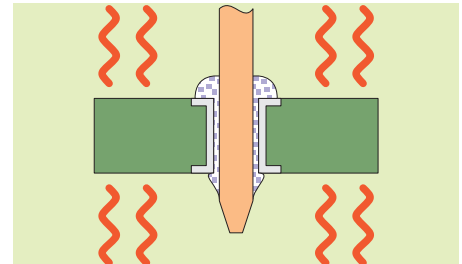

THR soldering joint

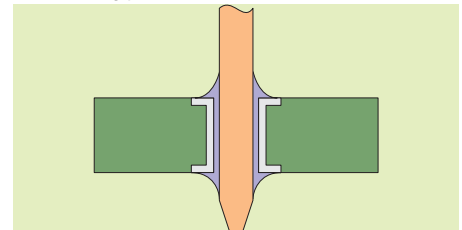

PCB Terminal Strips 2.5 mm²/AWG 14 Pin spacings 5 mm/0.197 in and 7.5 mm/0.295 in; Series 804

CAGE CLAMP®

1
VOLUME 2

Pin spacing 5 mm / 0.197 in 0.5 – 2.5 mm ² „s+f-st“ AWG 20 – 12 „s+f-st“ 250 V/4 kV/3; I _N 16 A 300 V, 10 A 500 V/4 kV/2; I _N 16 A	Pin spacing 7.5 mm / 0.295 in 0.5 – 2.5 mm ² „s+f-st“ AWG 20 – 12 „s+f-st“ 400 V/6 kV/3; I _N 16 A 300 V, 10 A 800 V/6 kV/2; I _N 16 A	Accessoires Internal commoning
10 – 11 mm / 0.41 in *	10 – 11 mm / 0.41 in *	

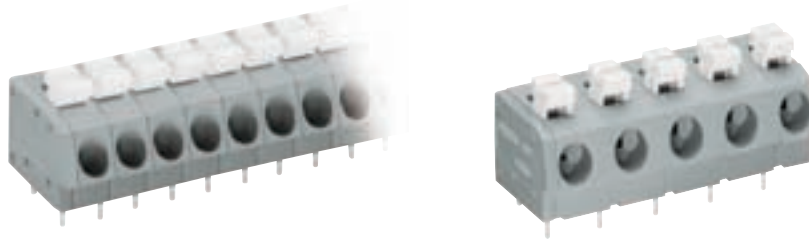

No. of poles	Item No.	Pack. unit pcs	No. of poles	Item No.	Pack. unit pcs	Item No.	Pack. unit pcs
1-conductor terminal strips with push button, 2 solder pins/pole staggered, grey, with test slot for test pin Ø 1 mm/0.039 in			1-conductor terminal strips with push button, 2 solder pins/pole staggered, grey, with test slot for test pin Ø 1 mm/0.039 in			Marker cards, 100 self-adhesive strips per card	
2	804-102	420 (4 x 105)	2	804-302	320 (4 x 85)	Print - Pin spacing 5 mm/0.197 in 1-12 (300 x) 210-331/0500-0103 1 card 13-24 (300 x) 210-331/0500-0104 1 card	
3	804-103	280 (4 x 70)	3	804-303	220 (4 x 55)		
4	804-104	220 (4 x 55)	4	804-304	160 (4 x 40)	Print - Pin spacing 7.5 mm/0.295 in 1-16 (100 x) 210-331/0750-0202 1 card	
5	804-105	180 (4 x 45)	5	804-305	120 (4 x 30)		
6	804-106	140 (4 x 35)	6	804-306	100 (4 x 25)		
7	804-107	120 (4 x 30)	7	804-307	80 (4 x 20)		
8	804-108	100 (4 x 25)	8	804-308	80 (4 x 20)		
9	804-109	100 (4 x 25)	9	804-309	60 (4 x 15)		
10	804-110	80 (4 x 20)	10	804-310	60 (4 x 15)		
11	804-111	80 (4 x 20)	11	804-311	60 (4 x 15)		
12	804-112	60 (4 x 15)	12	804-312	40 (4 x 10)		
13	804-113	60 (4 x 15)				Direct printing on request Test pin, Ø 1 mm/0.039 in 735-500 1 Test wire for sold. onto test plug	
14	804-114	60 (4 x 15)				Screwdriver with partially insulated shaft, 3.5 x 0.4 mm/0.137 in x 0.016 in 210-620 1	
15	804-115	60 (4 x 15)					
16	804-116	40 (4 x 10)					
Pin spacing 10 mm (with spacer) on request							

Additional item number for coloured terminal strips
 red .../000-005 ● Ordering example
 blue .../000-006 ① Terminal strip, pin spacing 5 mm/0.197 in, 8 poles,
 orange .../000-012 ● orange **804-108/000-012**
 light green .../000-017 ●
 ① Terminal blocks with blue insulation are suitable for
 Ex i applications (only for pin spacing 7.5 mm/
 0.295 in and 10 mm/0.394 in)

Dimensions (in mm)

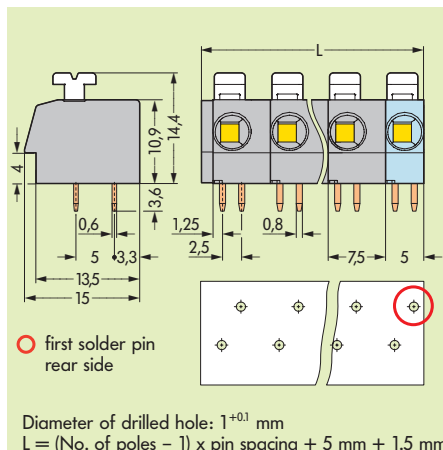
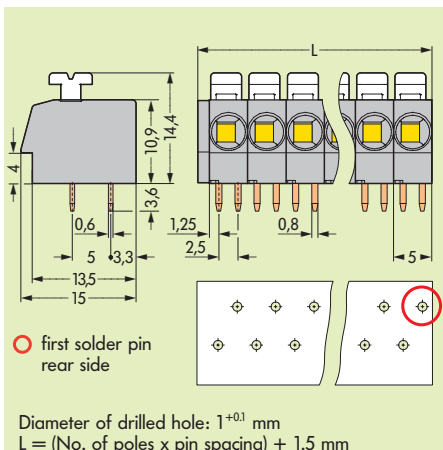

*Marks and approval data can be found on the Internet at www.wago.com.

2-Conductor Female Connector Strips 1.5 mm²/AWG 16 Pin Spacing 5 mm/0.197 in, Series 806

Pin spacing 5 mm / 0.197 in
2 x 0.2 – 1.5 mm² | 2 x AWG 24 – 16
250 V / 2.5 kV/3 ① | 300 V, 10 A

9 – 10 mm / 0.37 in

*

Pin spacing 5 mm / 0.197 in
2 x 0.2 – 1.5 mm² | 2 x AWG 24 – 16
250 V / 2.5 kV/3 ① | 300 V, 10 A

9 – 10 mm / 0.37 in

*

① 250 V = rated voltage
2.5 kV = rated surge voltage
3 = pollution degree
(see also Full Line Catalog W4 Volume 2, Section 12)



Connection of solid conductors:
insert wire up to the stop

Connection/disconnection of fine-stranded conductors:
open clamping unit using a screwdriver and insert stripped wire up to the stop

No. of poles	Item No.	No. of poles	Item No.
Female connector strips, grey		Female connector strips with removal aid, grey	
for solder pin strip		for solder pin strip	
2	806-102	2	806-202
3	806-103	3	806-203
4	806-104	4	806-204
5	806-105	5	806-205
6	806-106	6	806-206
7	806-107	7	806-207
8	806-108	8	806-208
9	806-109	9	806-209
10	806-110	10	806-210
11	806-111	11	806-211
12	806-112	12	806-212
For other lengths, please contact factory		For other lengths, please contact factory	
Additional item numbers for colored terminal strips		Additional item numbers for colored terminal strips	
blue	.../000-006	blue	.../000-006
orange	.../000-012	orange	.../000-012
Accessories			
	Solder pin strip, connector pin Ø 1.3 mm solder pin Ø 1 mm 2 to 12 poles 806-902 to 806-912		Solder pin strip, connector pin Ø 1.3 mm solder pin Ø 1 mm 2 to 12 poles 806-902 to 806-912
	Marker card, with self-adhesive marker strips		Marker card, with self-adhesive marker strips
1 – 16 (160 x)	210-332/0500-0202 1 card	1 – 16 (160 x)	210-332/0500-0202 1 card
Direct printing on request		Direct printing on request	
Dimensions (in mm) Diameter of drilled hole: 1.3 mm L = No. of poles x pin spacing + 1.5 mm			



Connecting the conductor directly into the connector ...
...or pre-assembled



Removing the terminal blocks to place the board

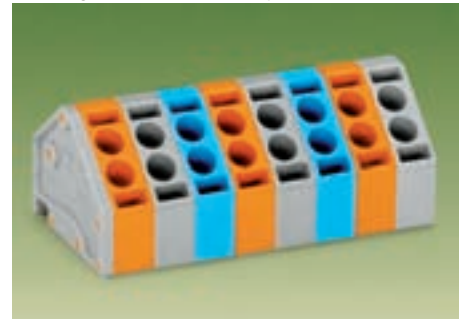

Terminal strip insulation housings mixed in different colors on request

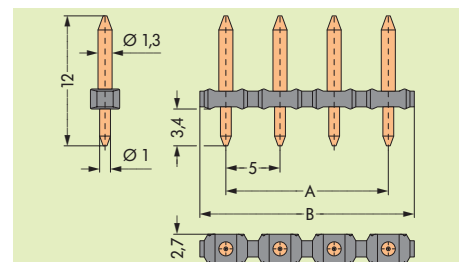
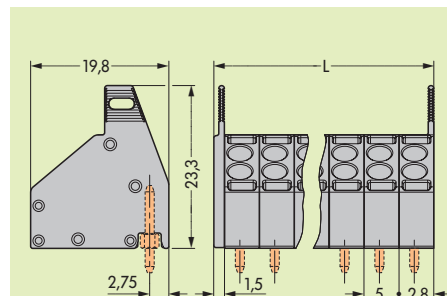
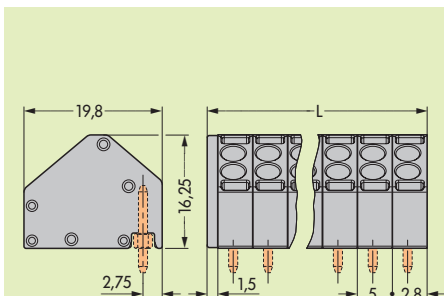

A = (No. of poles - 1) x pin spacing
B = (No. of poles - 1) x pin spacing + 4.8 mm

*Further approvals with corresponding ratings can be found at www.wago.com

Modular Terminal Blocks and Terminal Strips 6 mm²/AWG 10 **CAGE CLAMP® S** Pin Spacing 7.5 mm/0.295 in; Series 746

Pin spacing 7.5 mm / 0.295 in
 2 x 0.5 – 6 (10) mm² ① | 2 x AWG 20 – 8
 400 V/6 kV/3 | 600 V, 50 A 
 I_N 41 A
 13 – 15 mm / 0.55 in

* 

① Push-in conductor sizes: 0,5 mm² – 10 mm² „e+f“;
 AWG 16 – 8 (1,5 mm² – 10 mm²) „s“ and
 AWG 16 – 10 (1,5 mm² – 6 mm²)
 “insulated ferrules, 12 mm/0.472 in”

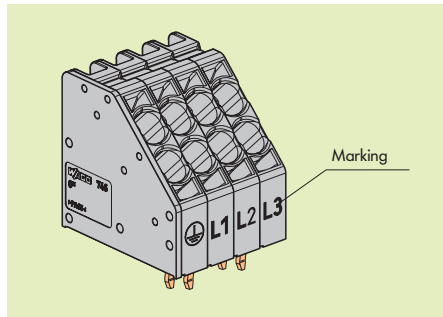

Connecting flexible wires using a screwdriver 5.5 mm

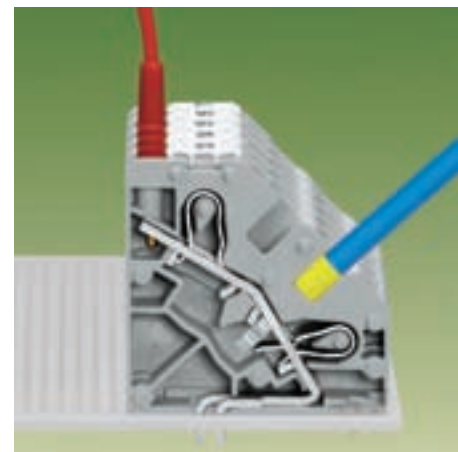







Solid wires and fine-stranded wires with ferrules can be simply pushed in

Testing with test plug Ø 2 mm/0.079 in



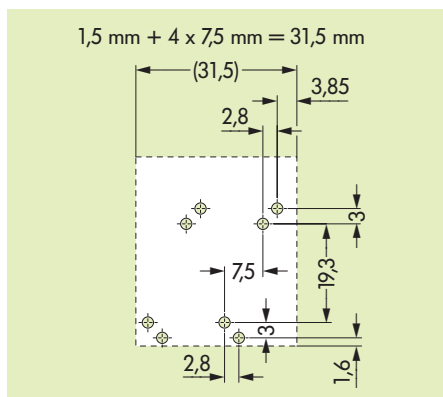
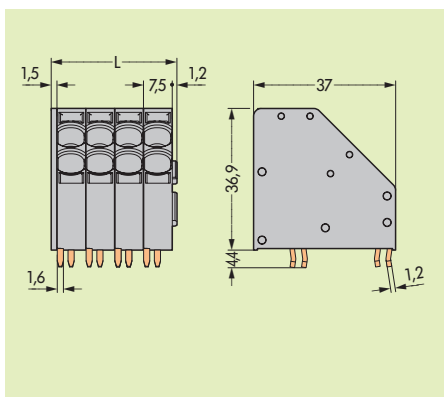

Terminal blocks of different colors upon request

No. of poles	Item No.	No. of poles	Item No.
2-conductor terminal strips, grey,			
2 x 2 pins / pole staggered			
2	746-2302		
3	746-2303		
4	746-2304		
5	746-2305		
6	746-2306		
7	746-2307		
8	746-2308		
9	746-2309		
10	746-2310		
12	746-2312		
For other lengths, please contact factory			
Additional item numbers for colored terminal strips			
light grey	.../000-009 		
blue	.../000-006 		
green-yellow	.../000-016 		
light green	.../000-017 		
Accessories (Marking see Full Line Catalog W4 Volume 2, Section 11)			
Screwdriver with partially insulated shaft			
	(5.5 x 0.8) mm 210-621		
Test plug			
	with cable 500 mm/1.77"		
	210-136 2 mm/0.079 in Ø, red		
	210-137 2.3 mm/0.091 in Ø, yell.		
Dimensions (in mm) Diameter of drilled hole: 2.2 ^{+0.1} mm L = No. of poles x pin spacing + 2.7 mm			





1 Modular Terminal Blocks and Terminal Strips without Jumper Slot 4 mm²/AWG 12 Pin Spacing 5 mm/0.197 in; Series 745

VOLUME 2









Pin spacing 5 mm / 0.197 in
 0.08 – 4 mm² | AWG 28 – 12
 250 V/4 kV/3 | 300 V, 20 A 
 I_N 32 A
 8 – 9 mm / 0.33 in

* 

Pin spacing 5 mm / 0.197 in
 0.08 – 4 mm² | AWG 28 – 12
 250 V/4 kV/3 | 300 V, 20 A 
 I_N 32 A
 8 – 9 mm / 0.33 in

* 



Color	Item No.	Pack.-unit pcs
Modular terminal blocks without jumper slot, 2 solder pins/pole		
grey	745-3801 	200 (2 x 100)
light grey	745-3803 	200 (2 x 100)
blue	745-3804 	200 (2 x 100)
green-yellow	745-3807 	200 (2 x 100)
light green	745-3808 	200 (2 x 100)
Accessoires		
End plate, snap-on type, 1.5 mm / 0.059 in thick		
	grey	745-3100 100
Spacer, 2.5 mm / 0.098 in thick		
	grey	745-3138 for extending the pin spacing
Test plug, with cable 500 mm / 1.77"		
	Ø 2 mm / 0.079 in, red	210-13650
	Ø 2.3 mm / 0.091 in, yel.	210-13750
Dimensions (in mm)		



Saving space
 2 terminal strips can be arranged in front of each other

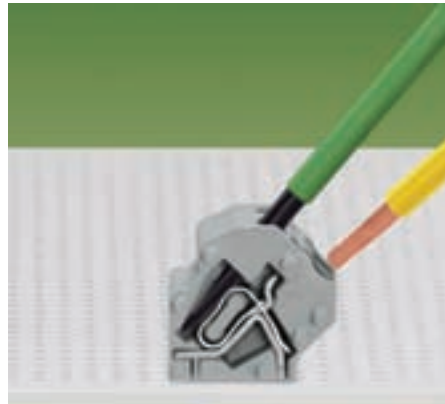

Wire connection using a screwdriver 3.5 mm / 0.138 in

No. of poles	Item No.
Terminal strips without jumper slot, grey, 2 solder pins/pole	
2	745-3102
3	745-3103
4	745-3104
5	745-3105
6	745-3106
7	745-3107
8	745-3108
9	745-3109
10	745-3110
12	745-3112
For assemblies in other lengths and colours, please contact factory.	
Dimensions (in mm)	

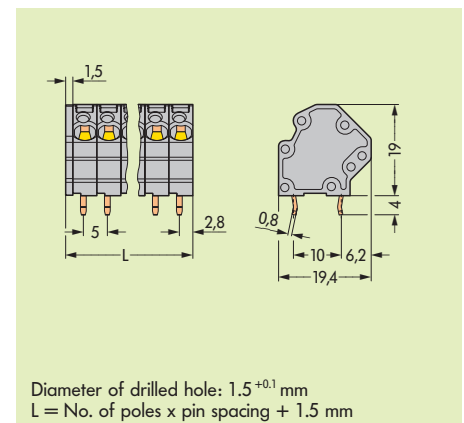
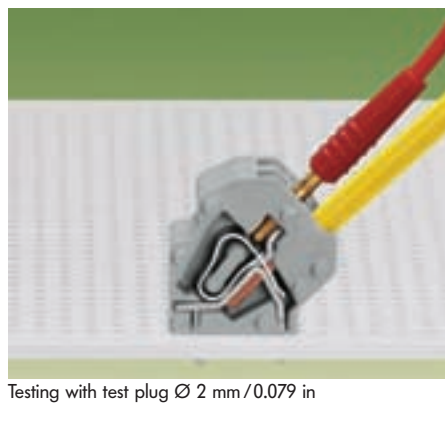
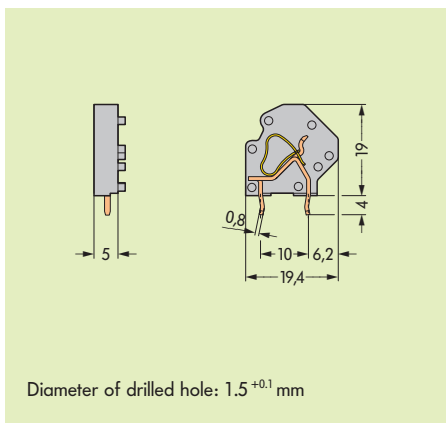









*Further approvals with corresponding ratings can be found at www.wago.com







Terminal Strips without Jumper Slot 4 mm²/AWG 12 Pin Spacings 7.5 mm/0.295 in, 10 mm/0.394 in, 12.5 mm/0.492 in; Series 745

CAGE CLAMP®

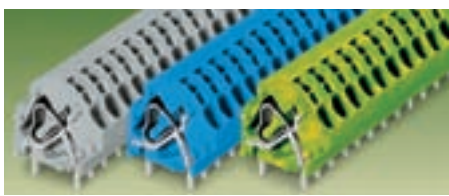
1
VOLUME 2

Pin spacing 7.5 mm / 0.295 in 0.08 – 4 mm ² AWG 28 – 12 500 V/6 kV/3 300 V, 20 A c  I _N 32 A  8 – 9 mm / 0.33 in * 	Pin spacing 10 mm / 0.394 in 0.08 – 4 mm ² AWG 28 – 12 630 V/8 kV/3 300 V, 20 A c  I _N 32 A  8 – 9 mm / 0.33 in * 	Pin spacing 12.5 mm / 0.492 in 0.08 – 4 mm ² AWG 28 – 12 630 V/8 kV/3 300 V, 20 A c  I _N 32 A  8 – 9 mm / 0.33 in * 
--	---	---





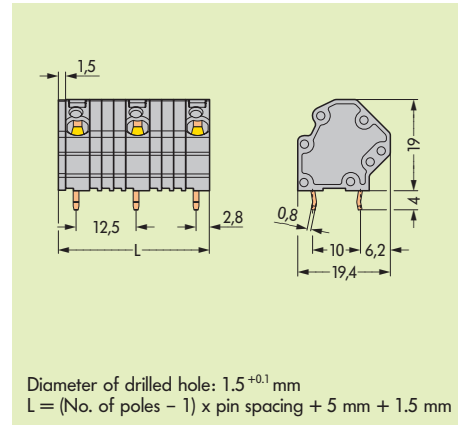
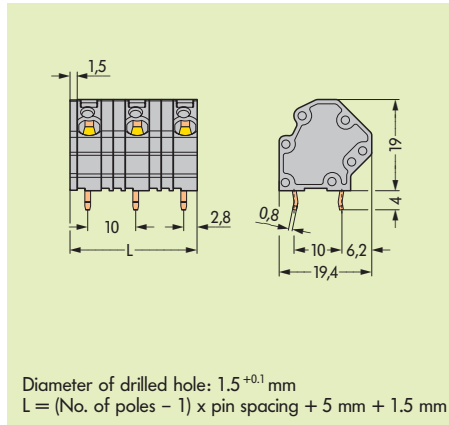
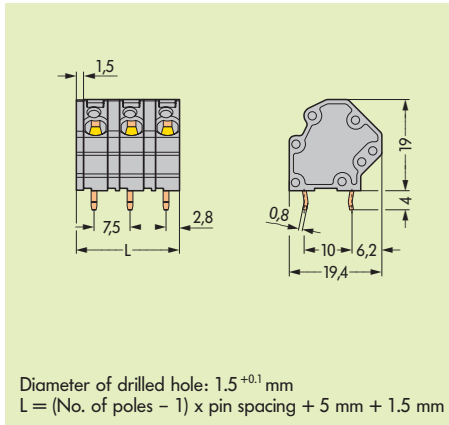

No. of poles	Item No.	No. of poles	Item No.	No. of poles	Item No.
Terminal strips		Terminal strips		Terminal strips	
without jumper slot, grey,		without jumper slot, grey,		without jumper slot, grey,	
2 solder pins/pole		2 solder pins/pole		2 solder pins/pole	
2	745-3152	2	745-3202	2	745-3252
3	745-3153	3	745-3203	3	745-3253
4	745-3154	4	745-3204	4	745-3254
5	745-3155	5	745-3205	5	745-3255
6	745-3156	6	745-3206	6	745-3256
7	745-3157	7	745-3207	7	745-3257
8	745-3158	8	745-3208	8	745-3258
9	745-3159	9	745-3209	9	745-3259
10	745-3160	10	745-3210	10	745-3260
12	745-3162	12	745-3212	12	745-3262
For assemblies in other lengths and colors, please contact factory.		For assemblies in other lengths and colors, please contact factory.		For assemblies in other lengths and colors, please contact factory.	
		Additional item Nos. for colored terminal strips and end plates		Ordering examples	
		blue	.../...-006 	Terminal strip, pin spacing 5 mm/0.197 in	
		light grey	.../...-009 	8 poles, light grey: 745-3108/000-009	
		green-yellow	.../...-016 	Terminal strip pin spacing 12 mm/0.492 in	
light green	.../...-017 	12 poles, blue: 745-3262/000-006			
		 Suitable for EEx i applications (only suitable for pin spacings 7.5 mm/0.295 in; 10 mm/0.394 in and 12.5 mm/0.492 in)			

Dimensions (in mm) (Mounting shall provide flexibility for the PCB.)













1 Modular Terminal Blocks 6 mm²/AWG 10, Series 745, Pin Spacings 7.5 mm / 0.295 in and 10 mm / 0.394 in

Pin spacing 7.5 mm / 0.295 in 0.2 – 6 mm ² 400 V/6 kV/3 I _N 32 A  11 – 12 mm / 0.45 in * 	Pin spacing 10 mm / 0.394 in 0.2 – 6 mm ² 630 V/8 kV/3 I _N 32 A  11 – 12 mm / 0.45 in * 	Spacer
---	--	---------------



Color	Item No.	Pack.-unit pcs	Color	Item No.	Pack.-unit pcs	Color	Item No.	Pack.-unit pcs
Modular terminal blocks, 2 solder pins / pole			Modular terminal blocks, 2 solder pins / pole			Spacer, 2.5 mm wide		
grey	745-831	100 (2 x 50)	grau	745-841	100 (2 x 50)	grey	745-338	
light grey	745-833	100 (2 x 50)	light grey	745-843	100 (2 x 50)			
blue	745-834	100 (2 x 50)	blue	745-844	100 (2 x 50)			
green-yellow	745-837	100 (2 x 50)	green-yellow	745-847	100 (2 x 50)			
light green	745-838	100 (2 x 50)	light green	745-848	100 (2 x 50)			
① suitable for Ex i applications			① suitable for Ex i applications					

Accessories (for WMB marking accessories and miniature WSB marking accessories see Full Line Catalog W4 Volume 1, Section 11)

	End plate, snap-on type 1.6 mm / 0.063 in thick grey 745-300 100		End plate, snap-on type 1.6 mm / 0.063 in thick grey 745-300 100
	End plate with fixing flange, grey 745-340 100		End plate with fixing flange, grey 745-340 100
	End plate with fixing flange, grey 745-345 100		End plate with fixing flange, grey 745-345 100
	Test plug, w. cable 500 mm / 17.7" Ø 2 mm / 0.079 in, red 210-136 50 Ø 2.3 mm / 0.091 in, yel. 210-137 50		Test plug, w. cable 500 mm / 17.7" Ø 2 mm / 0.079 in, red 210-136 50 Ø 2.3 mm / 0.091 in, yel. 210-137 50
	Comb type jumper bar 1 to 3 745-381 250 (5 x 50) 2-way 745-382 250 (5 x 50) 3-way 745-383 250 (5 x 50) 4-way 745-384 200 (4 x 50) 5-way 745-385 200 (4 x 50) 10-way 745-380 200 (4 x 50)		Comb type jumper bar 1 to 3 745-391 250 (5 x 50) 2-way 745-392 250 (5 x 50) 3-way 745-393 250 (5 x 50) 4-way 745-394 200 (4 x 50) 5-way 745-395 200 (4 x 50) 10-way 745-390 200 (4 x 50)

Dimensions (in mm)

Application notes

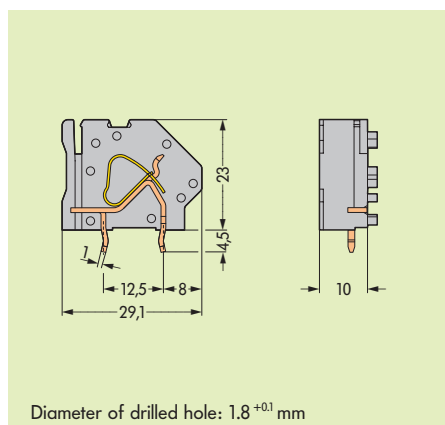
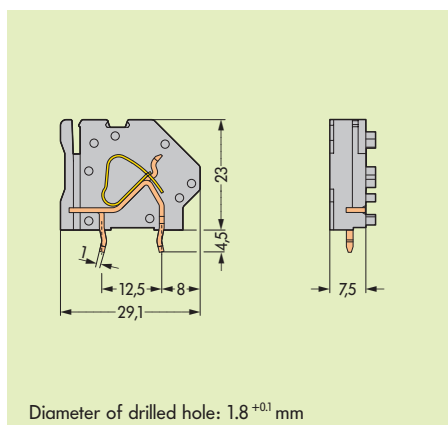

Higher rated voltages are possible using terminal strips with spacers so that 600 V to UL 1059 can be achieved without limitation at only 12.5 mm / 0.492 in pin spacing.



*Further approvals with corresponding ratings can be found at www.wago.com

Terminal Strips 6 mm²/AWG 10 with Spacers

Pin Spacings 10 mm/0.394 in, 12.5 mm/0.492 in and 15 mm/0.591 in; Series 745

CAGE CLAMP®

1
VOLUME 2

Pin spacing 10 mm / 0.394 in 0.2 – 6 mm ² 630 V/8 kV/3 I _N 32 A  11 – 12 mm / 0.45 in	Pin spacing 12.5 mm / 0.492 in 0.2 – 6 mm ² 800 V/8 kV/3 I _N 32 A  11 – 12 mm / 0.45 in	Pin spacing 15 mm / 0.591 in 0.2 – 6 mm ² 1000 V/10 kV/3 I _N 32 A  11 – 12 mm / 0.45 in
---	---	---

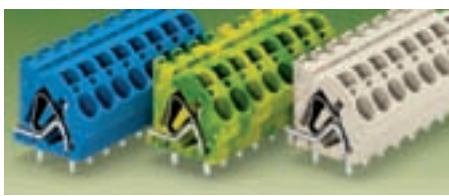

No. of poles	Item No.	Pack.-unit pcs	No. of poles	Item No.	Pack.-unit pcs	No. of poles	Item No.	Pack.-unit pcs
Terminal strips without fixing flanges, grey, with spacers			Terminal strips without fixing flanges, grey, with spacers			Terminal strips without fixing flanges, grey, with spacers		
2 solder pins /pole			2 solder pins /pole			2 solder pins /pole		
2	745-1352	104	2	745-1402		2	745-1452	
3	745-1353	72	3	745-1403		3	745-1453	
4	745-1354	48	4	745-1404		4	745-1454	
5	745-1355	40	5	745-1405		5	745-1455	
6	745-1356	32	6	745-1406		6	745-1456	
7	745-1357	24	7	745-1407		7	745-1457	
8	745-1358	24	8	745-1408		8	745-1458	
9	745-1359	16	9	745-1409		9	745-1459	
10	745-1360	16	10	745-1410		10	745-1460	
12	745-1362	16	12	745-1412		12	745-1462	
Additional item no. for terminal strips with fixing flanges .../005-000			Additional item no. for terminal strips with fixing flanges .../005-000			Additional item no. for terminal strips with fixing flanges .../005-000		
① Using jumpers, the UL current is reduced to 10 A at pin spacing 10 mm			For assemblies in other lengths and colors, please contact factory.			For assemblies in other lengths and colors, please contact factory.		
For assemblies in other lengths and colors, please contact factory.			Additional item nos. for colored terminal strips and end plates			Ordering examples		
			blue .../...-006 ①			Terminal strip, pin spacing 12.5 mm/0.492 in		
			light grey .../...-009 ○			8 poles, light grey: 745-1408/000-009		
			green-yellow .../...-016 ●			Terminal strip with fixing flanges, pin spacing 15 mm/0.591 in		
			light green .../...-017 ●			12 poles, blue: 745-1462/005-006		
			① Suitable for Ex i applications					



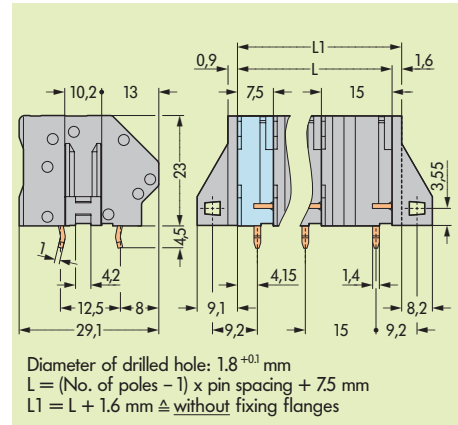
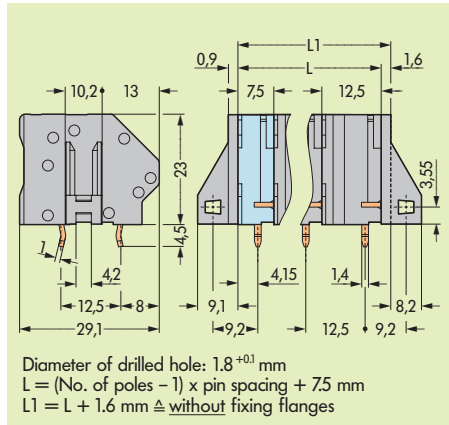
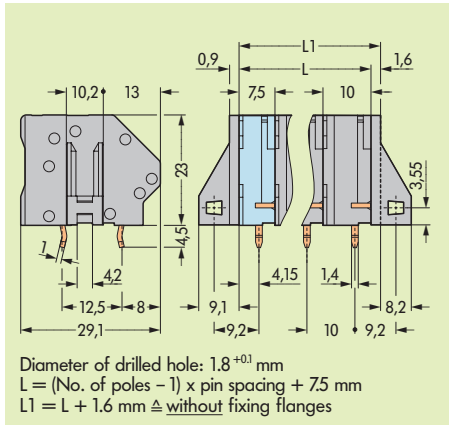

Dimensions (in mm) (Mounting shall provide flexibility for the PCB.)



MULTI CONNECTION SYSTEM **MINI**

Headers with Solder Pins, **Reflow Soldering**

100 % Protected against Mismatching, Pin spacing 3.5 mm/0.138 in

Pin spacing 3.5 mm/0.138 in, black 250 V/2.5 kV/2 300 V, 10 A  I _N 10 A	Pin spacing 3.5 mm/0.138 in, black 250 V/2.5 kV/2 300 V, 10 A  I _N 10 A	
* 	* 	

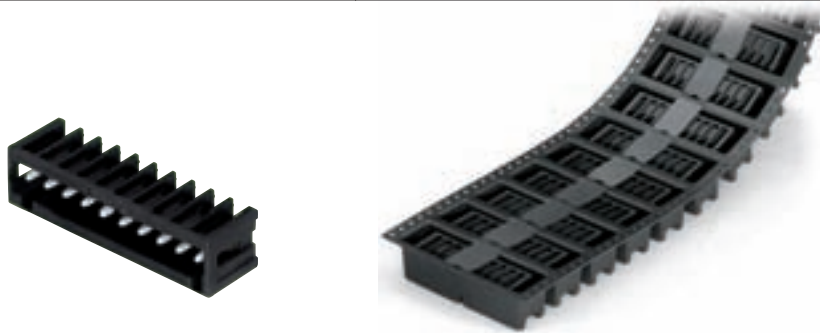

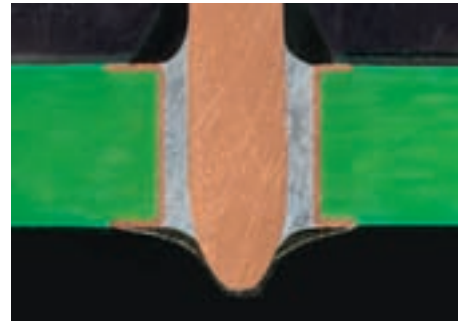

No. of poles	Item No.	No. of poles	Item No.	Width of reel (W)
Headers with solder pins, 100 % protected against mismatching, black, right angle solder pin 1 mm x 1 mm, length of solder pin 2.4 mm/0.094 in		Headers with solder pins, 100 % protected against mismatching, black, right angle solder pin 1 mm x 1 mm, length of solder pin 2.4 mm/0.094 in		
Headers in tape on reel acc. to IEC 60286-3				
Reel diameter 330 mm / 13 in (mm)				
2	734-162/105-604	2	734-162/105-604/997-405	32
3	734-163/105-604	3	734-163/105-604/997-405	32
4	734-164/105-604	4	734-164/105-604/997-405	32
5	734-165/105-604	5	734-165/105-604/997-405	32
6	734-166/105-604	6	734-166/105-604/997-407	56
8	734-168/105-604	8	734-168/105-604/997-407	56
10	734-170/105-604	10	734-170/105-604/997-407	56
12	734-172/105-604	12	734-172/105-604/997-407	56
280 pieces per reel				

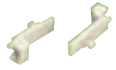

For use in reflow soldering processes in convection ovens based on EN 61760-1

- apply solder paste
- place components on PCB
- begin reflow soldering process

Accessories (fit after soldering)	
 Coding key, light grey, snap-on type 734-130	 Coding key, light grey, snap-on type 734-130

Dimensions Diameter of the plated through hole: 1.4^{+0.1} mm – optimized for PCB thickness up to 2 mm

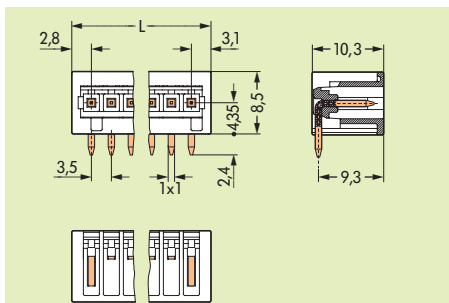

$L = (\text{No. of poles} - 1) \times \text{pin spacing} + 5.9 \text{ mm}$

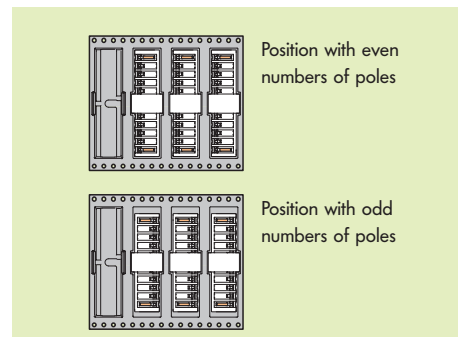
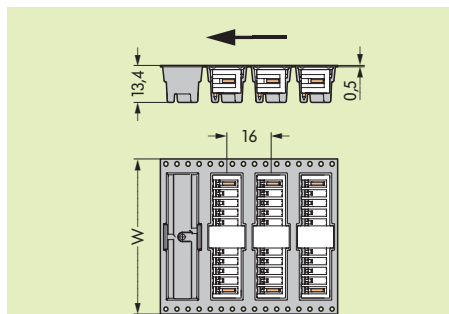

**Headers with Solder Pins,
Pin Spacing 5 mm/0.197 in**

Pin spacing 5 mm/0.197 in, black
250 V/4 kV/3 | 300 V, 10 A 
I_N 12 A

Pin spacing 5 mm/0.197 in, black
250 V/4 kV/3 | 300 V, 10 A 
I_N 12 A

* 

* 







No. of poles	Item No.	No. of poles	Item No.	Width of reel (W)
Headers with solder pins, black, straight solder pin 1 mm x 1 mm, length of solder pin 2.4 mm/0.094 in		Headers with solder pins, black, straight solder pin 1 mm x 1 mm, length of solder pin 2.4 mm/0.094 in		
		Headers in tape on reel acc. to IEC 60286-3		
		Reel diameter 330 mm/13 in (mm)		
2	231-132/001-000/105-604	2	231-132/001-000/105-604/997-405	32
3	231-133/001-000/105-604	3	231-133/001-000/105-604/997-405	32
4	231-134/001-000/105-604	4	231-134/001-000/105-604/997-407	56
5	231-135/001-000/105-604	5	231-135/001-000/105-604/997-407	56
6	231-136/001-000/105-604	6	231-136/001-000/105-604/997-407	56
8	231-138/001-000/105-604	8	231-138/001-000/105-604/997-407	56
10	231-140/001-000/105-604	10	231-140/001-000/105-604/997-409	88
12	231-142/001-000/105-604	12	231-142/001-000/105-604/997-409	88
		170 pieces per reel		



For use in reflow soldering processes in convection ovens based on EN 61760-1

- apply solder paste
- place components on PCB
- begin reflow soldering process

Accessories (fit after soldering)

	Coding key , snap-on type, light grey 231-129		Coding key , snap-on type, light grey 231-129
	Separator , for formation of groups, light grey 231-500		Separator , for formation of groups, light grey 231-500

Dimensions Diameter of the plated through hole: 1.4^{+0.1} mm – optimized for PCB thickness up to 2 mm

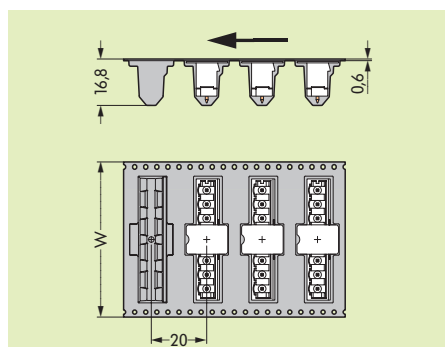
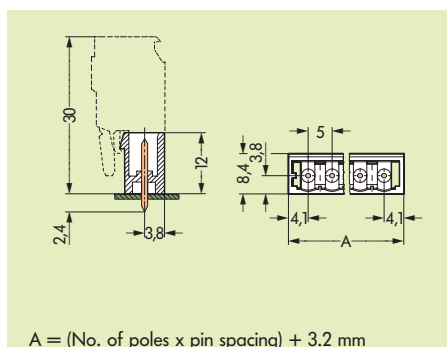





Note: These connectors can only be mated and unmated at voltages below 42 V and in the “No load” condition.

For mating and unmating at low power values, please request data.

*Further approvals with corresponding ratings can be found at www.wago.com

MULTI CONNECTION SYSTEM **MIDI** – Reflow Soldering

Headers with Solder Pins, Pin Spacing 5 mm/0.197 in

Pin spacing 5 mm/0.197 in, black 250 V/4 kV/3 300 V, 10 A  I _N 12 A	Pin spacing 5 mm/0.197 in, black 250 V/4 kV/3 300 V, 10 A  I _N 12 A	
* 	* 	





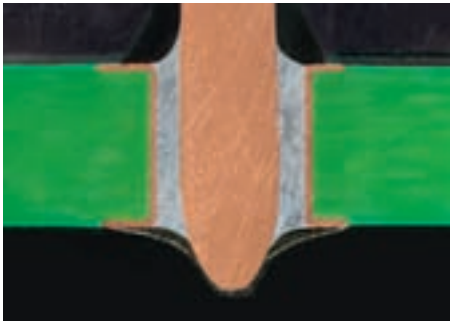

No. of poles	Item No.	No. of poles	Item No.	Width of reel (W)
Headers with solder pins, black, right angle solder pin 1 mm x 1 mm, length of solder pin 2.4 mm/0.094 in		Headers with solder pins, black, right angle solder pin 1 mm x 1 mm, length of solder pin 2.4 mm/0.094 in		
		Headers in tape on reel acc. to IEC 60286-3		
		Reel diameter 330 mm/13 in		(mm)
2	231-432/001-000/105-604	2	231-432/001-000/105-604/997-405	32
3	231-433/001-000/105-604	3	231-433/001-000/105-604/997-405	32
4	231-434/001-000/105-604	4	231-434/001-000/105-604/997-407	56
5	231-435/001-000/105-604	5	231-435/001-000/105-604/997-407	56
6	231-436/001-000/105-604	6	231-436/001-000/105-604/997-407	56
8	231-438/001-000/105-604	8	231-438/001-000/105-604/997-407	56
10	231-440/001-000/105-604	10	231-440/001-000/105-604/997-409	88
12	231-442/001-000/105-604	12	231-442/001-000/105-604/997-409	88
330 pieces per reel				



For use in reflow soldering processes in convection ovens based on EN 61760-1

- apply solder paste
- place components on PCB
- begin reflow soldering process

Accessories (fit after soldering)	
 Coding key , snap-on type, light grey 231-129	 Coding key , snap-on type, light grey 231-129
 Separator , for formation of groups, light grey 231-500	 Separator , for formation of groups, light grey 231-500

Dimensions Diameter of the plated through hole: 1.4^{+0.1} mm – optimized for PCB thickness up to 2 mm

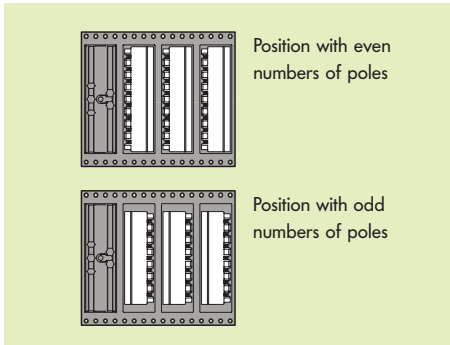
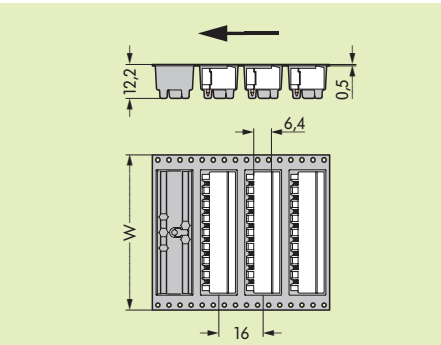
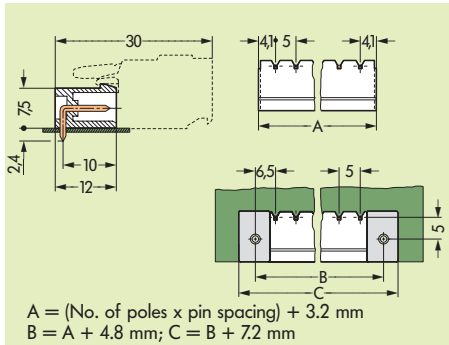

MULTI CONNECTION SYSTEM MINI – Extension of Pole Number
Connectors, 100% Protected against Mismatching
Pin Spacing 3.5 mm see also Full Line Catalog W4 Volume 2, pages 5.4 – 5.9



No. of poles	Item No.	No. of poles	Item No.
Headers with solder pins, straight solder pin 1 mm x 1 mm		Headers with solder pins, right angle solder pin 1 mm x 1 mm	
14	734-144	14	734-174

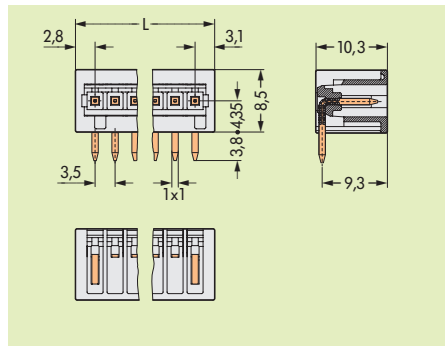
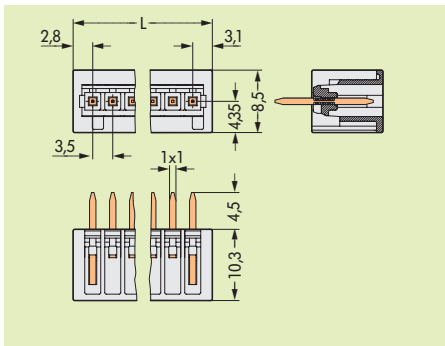

No. of poles	Item No.	No. of poles	Item No.	No. of poles	Item No.
Male connector with CAGE CLAMP® connection		Femal connector with CAGE CLAMP® connection, coding fingers		Femal connector with CAGE CLAMP® connection and locking device, coding fingers	
14	734-314	14	734-114	14	734-114/037-000

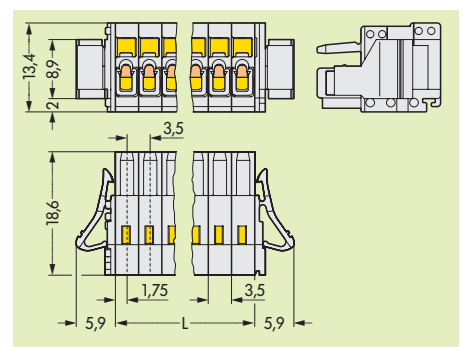
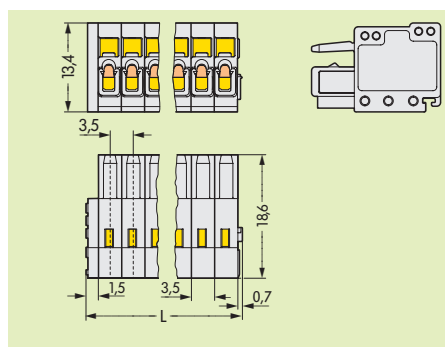
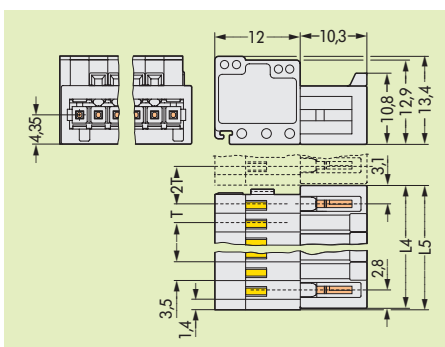







MULTI CONNECTION SYSTEM **MINI**

Combi Strip, 100 % Protected against Mismatching, Pin Spacing 3.5 mm / 0.138 in

CAGE CLAMP®

5

VOLUME 2

Pin spacing 3.5 mm/0.138 in, light grey 0.08 – 1.5 mm ² 250 V/2.5 kV/2 I _N 10 A  7 mm / 0.28 in * 	Pin spacing 3.5 mm/0.138 in, light grey 0.08 – 1.5 mm ² 250 V/2.5 kV/2 I _N 10 A  7 mm / 0.28 in * 
AWG 28 – 14** 300 V, 10 A 	AWG 28 – 14** 300 V, 10 A 









No. of poles	Item No.	No. of poles	Item No.
Combi strip with CAGE CLAMP® connection, 100% protected against mismatching,		Combi strip with CAGE CLAMP® connection and locking levers, 100 % protected against mismatching,	
pin and socket connection, with coding fingers, light grey		with coding fingers, light grey	
2	734-362	2	734-362/037-000
3	734-363	3	734-363/037-000
:	:	:	:
6	734-366	6	734-366/037-000
7	734-367	7	734-367/037-000
8	734-368	8	734-368/037-000
9	734-369	9	734-369/037-000
10	734-370	10	734-370/037-000
12	734-372	12	734-372/037-000



Combi strip

The combination of pin and socket connections allows the assembly of many combi strips.
2 CAGE CLAMP® connections allow the looping through of potentials.

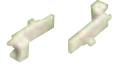
Accessories

Marker cards,  80 self-adhesive strips per card Marking 1 – 16 (240x) 210-332/0350-0202 17 – 32 (240x) 210-332/0350-0204 For further printings see W4 Volume 2, Section 11 For direct printing please contact factory	Marker cards,  80 self-adhesive strips per card Marking 1 – 16 (240x) 210-332/0350-0202 17 – 32 (240x) 210-332/0350-0204 For further printings see W4 Volume 2, Section 11 For direct printing please contact factory
 Screwdriver, (2.5 x 0.4) mm (0.098 x 0.016) in 210-619	 Screwdriver, (2.5 x 0.4) mm (0.098 x 0.016) in 210-619
 Coding key, snap-on type, light grey 734-130	 Coding key, snap-on type, light grey 734-130

Dimensions (in mm) $L_4 = (\text{No. of poles} - 1) \times \text{pin spacing} + 5.9 \text{ mm} + 0.45 \text{ mm}$

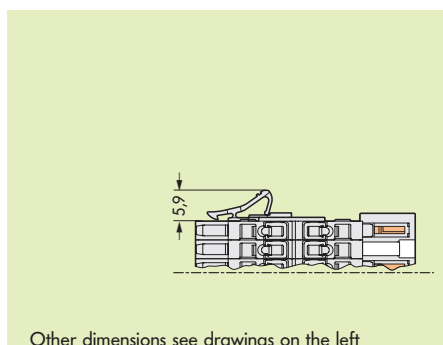
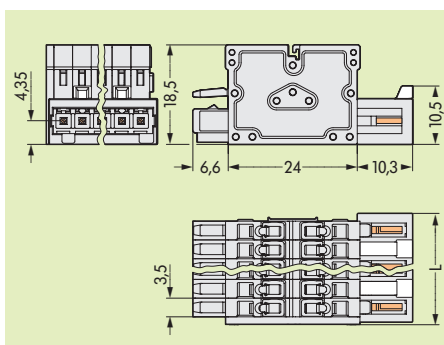

* Approvals with corresponding ratings see www.wago.com
 ** AWG 14: THHN, THWN

MULTI CONNECTION SYSTEM **MINI** and **MIDI**

Connection Tool

Connection tool for pin spacings
3.5 mm/0.138 in
and 3.81 mm/0.15 in

Connection tool for pin spacings
5 mm/0.197 in and 5.08 mm/0.2 in
and 7.5 mm/0.295 in
and 7.62 mm/0.3 in



Item No.	Item No.
Connection tool for male and female connectors with CAGE CLAMP® connection, Series 734	Connection tool for male and female connectors with CAGE CLAMP® connection, Series 231, 232, 721, 722, 723, 731, 732
black 734-231	natural 231-159



Wire connection
Wire entry and operation of the clamp are parallel to each other



Wire connection
Wire entry and operation of the clamp are parallel to each other



Wire connection
Wire entry and operation of the clamp is done at a right angle to each other



Wire connection
Wire entry and operation of the clamp is done at a right angle to each other

MULTI CONNECTION SYSTEM **MINI**

Female Connectors with Solder Pins, 100 % Protected against Mismatching
Pin Spacing 3.5 mm/0.138 in

Pin spacing 3.5 mm/0.138 in, light grey 250 V/2.5 kV/2 I _N 10 A	Pin spacing 3.5 mm/0.138 in, light grey 250 V/2.5 kV/2 I _N 10 A	Female connectors with solder pins and locking device
*	*	*



No. of poles	Item No.	No. of poles	Item No.	Additional item No. for . . .
Female connectors with straight solder pins, 100 % protected against mismatching, with coding fingers, with two latches, light grey, solder pin 0.9 mm x 0.9 mm		Female connectors with right angle solder pins, 100 % protected against mismatching, with coding fingers, with two latches, light grey, solder pin 0.9 mm x 0.9 mm		. . . Female connectors with straight or right angle solder pins and locking device
2 (one latch only)	734-462	2 (one latch only)	734-532	. . . / 037-000
3	734-463	3	734-533	
:	:	:	:	
6	734-466	6	734-536	
:	:	:	:	Ordering example:
10	734-470	10	734-540	Female connector with straight solder pins and locking device,
12	734-472	12	734-542	100 % protected against mismatching,
:	:	:	:	pin spacing 3.5 mm/0.138 in, light grey,
14	734-474	14	734-544	12-pole 734-472/037-000
16	734-476	16	734-546	
18	734-478	18	734-548	
20	734-480	20	734-550	
24	734-484	24	734-554	

Accessories

Marker cards,	Marker cards,	Marker cards,
80 self-adhesive strips per card	80 self-adhesive strips per card	80 self-adhesive strips per card
Marking 1 - 16 (240 x) 210-332/0350-0202 17 - 32 (240 x) 210-332/0350-0204 other markings see Full Line Catalog W4 Volume 2, Section 11 For direct printing, please contact factory	Marking 1 - 16 (240 x) 210-332/0350-0202 17 - 32 (240 x) 210-332/0350-0204 other markings see Full Line Catalog W4 Volume 2, Section 11 For direct printing, please contact factory	Marking 1 - 16 (240 x) 210-332/0350-0202 17 - 32 (240 x) 210-332/0350-0204 other markings see Full Line Catalog W4 Volume 2, Section 11 For direct printing, please contact factory

Dimensions (in mm) Diameter of drilled hole: 1.4^{+0.1} mm

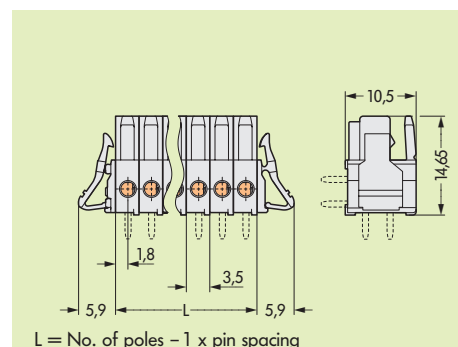
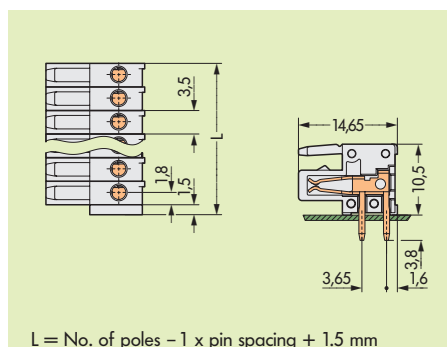
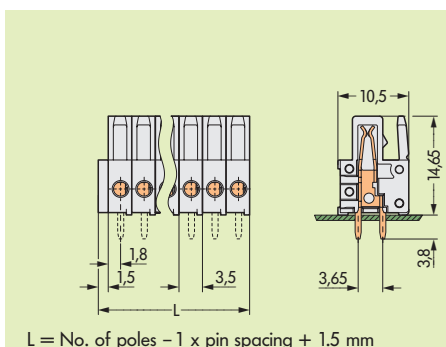

* Approvals with corresponding ratings see www.wago.com

MULTI CONNECTION SYSTEM **MINI**

Female Connectors with Solder Pins, 100% Protected against Mismatching Pin Spacing 3.81 mm/0.15 in

Pin spacing 3.81 mm/0.15 in, orange 250 V/2.5 kV/2 I _N 10 A	Pin spacing 3.81 mm/0.15 in, orange 250 V/2.5 kV/2 I _N 10 A	Female connectors with solder pins and locking device
*	*	*



No. of poles	Item No.	No. of poles	Item No.	Additional item No. for . . .
Female connectors with straight solder pins, 100% protected against mismatching, with coding fingers, with two latches, light grey, solder pin 0.9 mm x 0.9 mm		Female connectors with right angle solder pins, 100% protected against mismatching, with coding fingers, with two latches, light grey, solder pin 0.9 mm x 0.9 mm		. . . Female connectors with straight or right angle solder pins and locking device
2 (one latch only)	734-502	2 (one latch only)	734-562	. . . / 037-000
3	734-503	3	734-563	
4	734-504	4	734-564	
5	734-505	5	734-565	
6	734-506	6	734-566	
7	734-507	7	734-567	Ordering example:
8	734-508	8	734-568	Female connector with straight solder pins and locking device,
9	734-509	9	734-569	100% protected against mismatching,
10	734-510	10	734-570	pin spacing 3.81 mm/0.15 in, light grey,
12	734-512	12	734-572	8-pole 734-568/037-000
14	734-514	14	734-574	
16	734-516	16	734-576	
20	734-520	20	734-580	

Accessories

Marker cards,	Marker cards,	Marker cards,
80 self-adhesive strips per card	80 self-adhesive strips per card	80 self-adhesive strips per card
Marking 1 - 16 (240 x) 210-332/0381-0202 17 - 32 (240 x) 210-332/0381-0204 other markings see Full Line Catalog W4 Volume 2, Section 11 For direct printing, please contact factory	Marking 1 - 16 (240 x) 210-332/0381-0202 17 - 32 (240 x) 210-332/0381-0204 other markings see Full Line Catalog W4 Volume 2, Section 11 For direct printing, please contact factory	Marking 1 - 16 (240 x) 210-332/0381-0202 17 - 32 (240 x) 210-332/0381-0204 other markings see Full Line Catalog W4 Volume 2, Section 11 For direct printing, please contact factory

Dimensions (in mm) Diameter of drilled hole: 1.4^{+0.1} mm

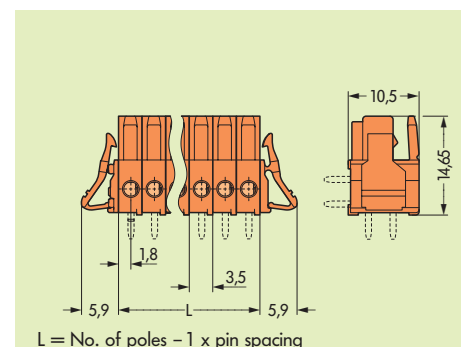
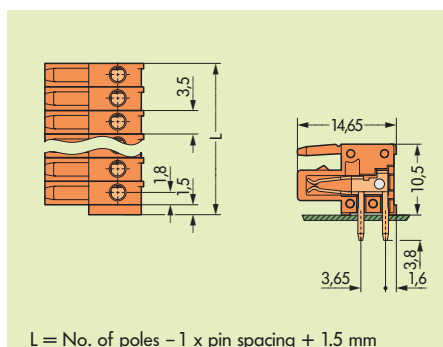
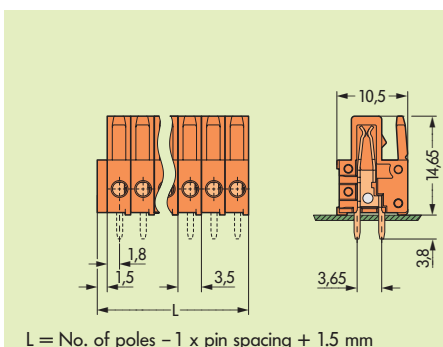

MULTI CONNECTION SYSTEM **MIDI**

Angled Female Connectors, **100% Protected against Mismatching**, **CAGE CLAMP®**
Pin Spacing 5 mm/0.197 in

Pin spacing 5 mm/0.197 in, light grey
0.08 – 2.5 mm² AWG 28 – 12**
250 V/4 kV/3 300 V, 15 A
I_N 14 A 300 V, 15 A

8 – 9 mm / 0.33 in

*

Pin spacing 5 mm/0.197 in, light grey
0.08 – 2.5 mm² AWG 28 – 12**
250 V/4 kV/3 300 V, 15 A
I_N 14 A 300 V, 15 A

8 – 9 mm / 0.33 in

*



No. of poles	Item No.	No. of poles	Item No.
Angled female connectors with CAGE CLAMP® connection, 100% protected against mismatching, conductor exit same direction as latches, with coding fingers, with 2 latches, light grey		Angled female connectors with CAGE CLAMP® connection, 100% protected against mismatching, conductor exit same direction as latches, with coding fingers, with 2 latches, light grey	
2 (one latch only)	722-202/026-000	2 (one latch only)	722-102/026-000
3	722-203/026-000	3	722-103/026-000
4	722-204/026-000	4	722-104/026-000
5	722-205/026-000	5	722-105/026-000
6	722-206/026-000	6	722-106/026-000
:	:	:	:
10	722-210/026-000	10	722-110/026-000
12	722-212/026-000	12	722-112/026-000
14	722-214/026-000	14	722-114/026-000
16	722-216/026-000	16	722-116/026-000
20	722-220/026-000	20	722-120/026-000

Accessories

	Test plug , w. cable 500 mm/1'7.7" Ø 2 mm/0.079 in, red 210-136 Ø 2.3 mm/0.091 in, yel. 210-137		Test plug , w. cable 500 mm/1'7.7" Ø 2 mm/0.079 in, red 210-136 Ø 2.3 mm/0.091 in, yel. 210-137
	Insulation stop , 5 pcs/strip 0.08 - 0.2 mm ² (white) 231-670 0.25 - 0.5 mm ² (light gr.) 231-671 0.75 - 1 mm ² (dark grey) 231-672		Insulation stop , 5 pcs/strip 0.08 - 0.2 mm ² (white) 231-670 0.25 - 0.5 mm ² (light gr.) 231-671 0.75 - 1 mm ² (dark grey) 231-672
	0.2 mm ² solid / 0.14 mm ² f-st		0.2 mm ² solid / 0.14 mm ² f-st

Dimensions (in mm)

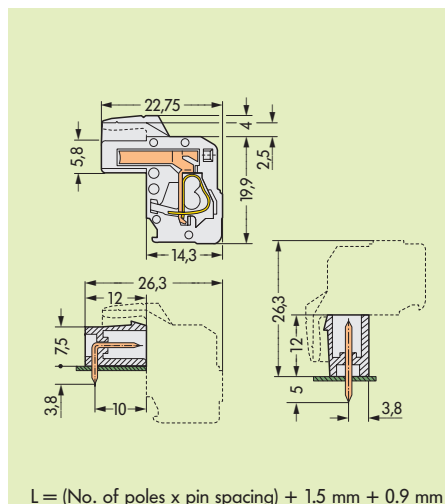
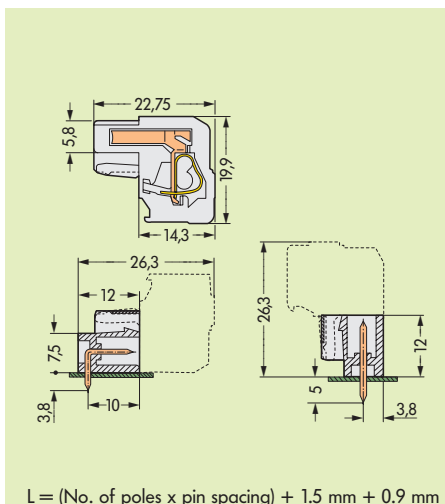

* Approvals with corresponding ratings see www.wago.com
** AWG 12: THHN, THWN

MULTI CONNECTION SYSTEM **MIDI** – Extension of Pole Number

Connectors with Right Angle Solder Pins

Pin Spacing 5 mm/0.197 in see also Full Line Catalog W4 Volume 2, page 7.15

Pin spacing 5 mm/0.197 in, light grey
 250 V/4 kV/3 | 300 V, 10 A ① ②
 I_N 12 A ①/I_N 16 A ② | 300 V, 15 A ② ③

* ABS

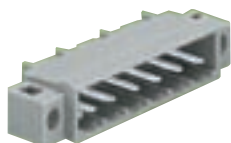

No. of poles	Item No.	Item No.
Headers with right angle solder pins and fixing flanges, grey,		
	solder pin 1 mm x 1 mm ①	1.2 mm x 1.2 mm ②
3	231-433/040-000	231-463/040-000
Female connectors with locking devices cannot be used.		
	Coding key , snap-on type, light grey	231-129
	Separator , for formation of groups, light grey	231-500



Additional mechanical safety
 The additional mechanical securing on the PCB or the fixing on panels/front plates in case of feedthrough applications are the main features of these headers. Depending on the wall thickness a recessed, flush or projecting mounting can be realized. Fixing of the header may be made with standard nuts and bolts (size M 2 or M 2.5).

Note: These connectors can only be mated and unmated at voltages below 42 V and in the "No load" condition.
 For mating and unmating at low power values, please request data.

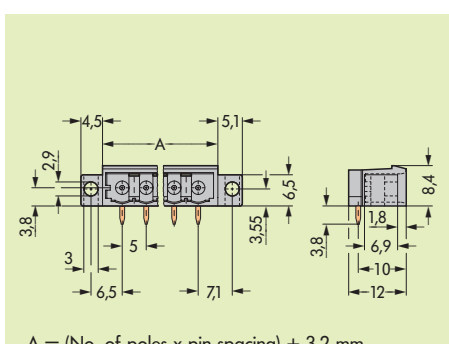

7 MULTI CONNECTION SYSTEM **MIDI**

Comb type jumper bars

Pin Spacings 5 mm / 0.197 in and 5.08 mm / 0.2 in

VOLUME 2

Pin spacings 5 mm/0.197 in, grey
5.08 mm/0.2 in, grey

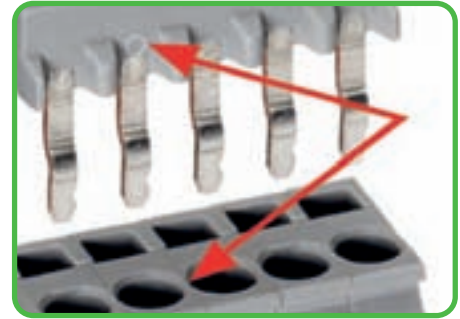

Attention! Insert jumper bar according to direction symbols.
 Symbol shows direction to operating slot
 Symbol shows direction to conductor entry

	Item No.	Pack.-unit pcs
Comb type jumper bars, insulated		
for straight and angled male and female connectors of Series 231 with CAGE CLAMP® connection		
Suitable for pin spacings 5 mm/0.197 in and 5.08 mm/0.2 in		
Attention!		
Not suitable for 2-conductor female connectors with CAGE CLAMP®S connection		
3-way	231-903	
5-way	231-905	
7-way	231-907	
10-way	231-910	
Accessories		
Operating tool, insulated,		
	3-way 280-433	1
	5-way 280-435	1



Insert comb type jumper bars with maximum 5 contacts using operating tool. Comb type jumper bars with more than 7 contacts are pre-assembled by WAGO



Individual comb type jumper bars are created by breaking out jumper contacts



Note: The maximum wire size is reduced to 1.5 mm²/AWG 16 solid and stranded ("s" + "f-st")

MULTI CONNECTION SYSTEM **MIDI** – Extension of Pole Number

Connectors with Screw/ Threaded flanges

Pin Spacing 5.08 mm / 0.2 in see also Full Line Catalog W4 Volume 2, pages 7.32 – 7.33

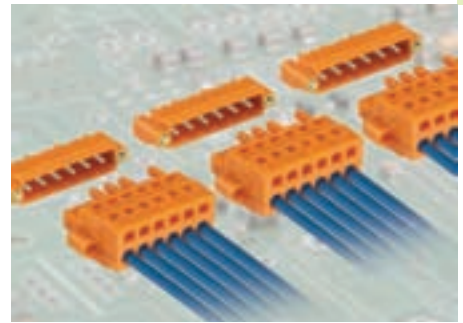
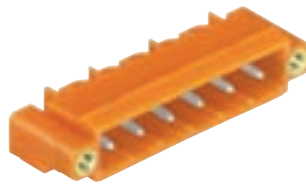
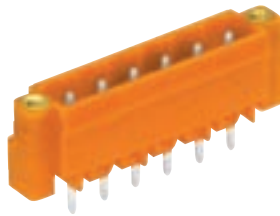

No. of poles	Item No.	No. of poles	Item No.
Headers with straight solder pins and threaded flanges, orange, solder pin 1 mm x 1 mm		Headers with right angle solder pins and threaded flanges, orange, solder pin 1 mm x 1 mm	
7	231-337/108-000	7	231-537/108-000
:	:	:	:
10	231-340/108-000	10	231-540/108-000
12	231-342/108-000	12	231-542/108-000
14	231-344/108-000	14	231-544/108-000
:	:	:	:
16	231-346/108-000	16	231-546/108-000

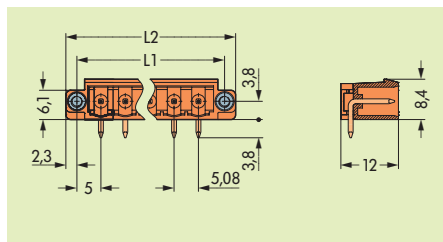
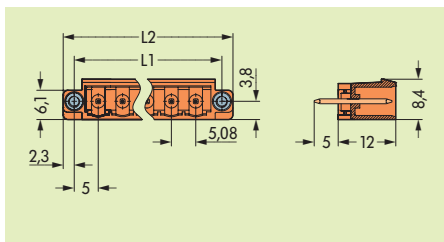

Pin spacing 5.08 mm/0.2 in, orange
0.2 – 2.5 mm² AWG 24 – 12
250 V/4 kV/3 300 V, 20/5 A
I_N 16 A

9 – 10 mm / 0.37 in

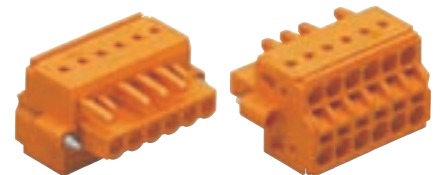

No. of poles	Item No.	No. of poles	Item No.	No. of poles	Item No.
Male connectors with CAGE CLAMP® and threaded flanges, orange		Female connectors with CAGE CLAMP® and screw flanges, with coding fingers, with two latches, orange		2-conductor female connectors with CAGE CLAMP® and screw flanges, with coding fingers, with two latches, orange	
7	231-637/109-000	7	231-307/107-000	2 (only 1 latch)	231-2302/107-000
:	:	:	:	3 (only 1 latch)	231-2303/107-000
10	231-640/109-000	10	231-310/107-000	4	231-2304/107-000
12	231-642/109-000	12	231-312/107-000	:	:
14	231-644/109-000	14	231-314/107-000	10	231-2310/107-000
:	:	:	:	:	:
16	231-646/109-000	16	231-316/107-000	16	231-2316/107-000

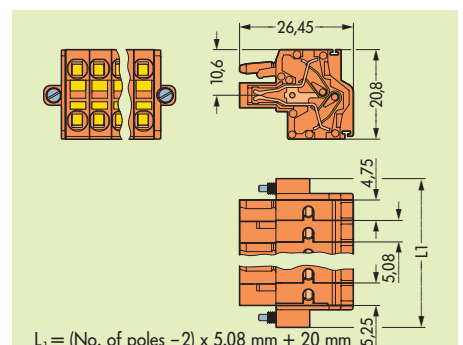
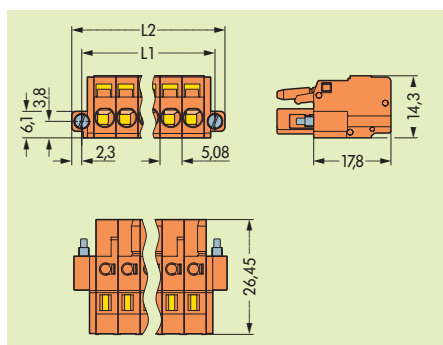
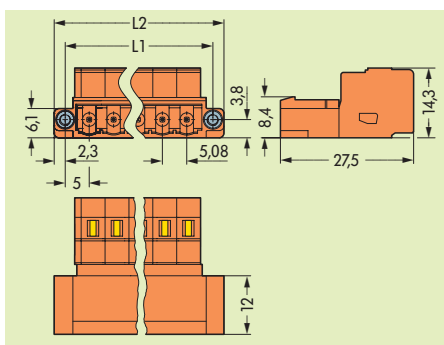

MULTI CONNECTION SYSTEM MIDI

Strain relief plates for 2-Conductor Female Connectors

Pin Spacings 5 mm/0.197 in; 5.08 mm/0.2 in; 7.5 mm/0.295 in and 7.62 mm/0.3 in



Ordering examples for for 2-conductor female connectors with CAGE CLAMP[®]S connection and **strain relief plates**

Description	Width	Additional item No.
Strain relief plate, fixed	6 mm	.../132-000
	12.5 mm	.../133-000
	25 mm	.../134-000
	35 mm	.../135-000
	55 mm	.../136-000
	75 mm	.../137-000

Application notes

2-conductor female connectors with CAGE CLAMP[®]S connection can be fitted with a strain relief plate retrospectively or directly at the factory. Plates are available in 6 different sizes. An "additional item no.", referring to the width of the strain relief plate, is added to the "basic item no." and determines the type of connector (see ordering examples). The arrangement of the fixing holes for cable ties allow single conductors or multicore cables to be attached in several different orientations.

Strain relief plate			... female conn. ranges as stated below		Cable ties*		
Item No.	Color	Width	Pin spacings 5 mm/5.08 mm	Pin spacings 7.50 mm/7.62 mm	Width	Type	MIL
734-127 734-327 734-227	light grey grey orange	6 mm	2 poles		2.5 mm	T 18 R	MS 3367
734-128 734-328 734-228	light grey grey orange	12.5 mm	3 – 4 poles	2 – 3 poles	2.5 mm	T 18 R	
734-129 734-329 734-229	light grey grey orange	25 mm	5 – 7 poles	4 – 6 poles	2.5 mm 3.6 mm	T 18 R T 30 R	
734-126 734-326 734-226	light grey grey orange	35 mm	8 – 11 poles	7 – 9 poles	2.5 mm 3.6 mm	T 18 R T 30 R	
734-426 734-430 734-428	light grey grey orange	① 55 mm	12 – 16 poles	10 – 12 poles	2.5 mm 3.6 mm 4.0 mm 4.7 mm	T 18 R T 30 R T 40 R T 50 R	
734-427 734-431 734-429	light grey grey orange	② 75 mm	17 – 24 poles	13 – 16 poles	2.5 mm 3.6 mm 4.0 mm 4.7 mm	T 18 R T 30 R T 40 R T 50 R	

* Cable binding tool MK III Item No.



Female connector, pin spacing 5 mm/0.197 in, grey 8 poles, with strain relief plate
231-2108/026-000/135-000



Female connector, pin spacing 5 mm/0.197 in, grey 11 poles, with strain relief plate
231-2111/026-000/135-000



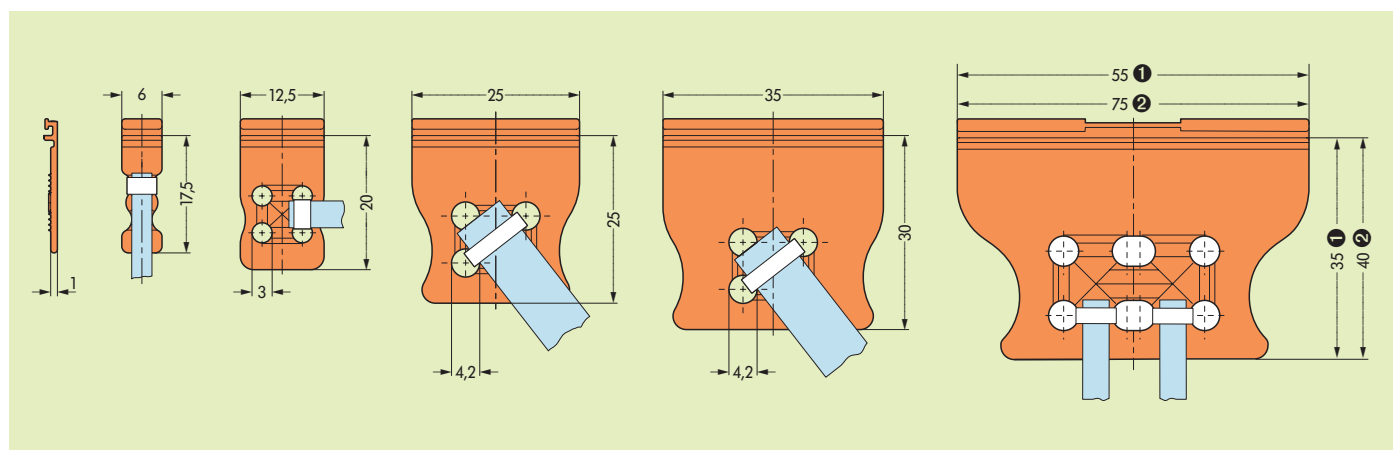

Dimensions (in mm)



* Recommended cable ties and cable binding tool from Tyton or Hellermann, not offered by WAGO

MULTI CONNECTION SYSTEM MAXI

Headers with Solder Pins, 100 % Protected against Mismatching, Pin Spacing 7.62 mm / 0.3 in

Pin spacing 7.62 mm/0.3 in, light grey 500 V/6 kV/3 300/600 V, 42/5 A  I _N 41 A 300/600 V, 50/5 A 	Pin spacing 7.62 mm/0.3 in, light grey 500 V/6 kV/3 300/600 V, 42/5 A  I _N 41 A 300/600 V, 50/5 A 
---	---

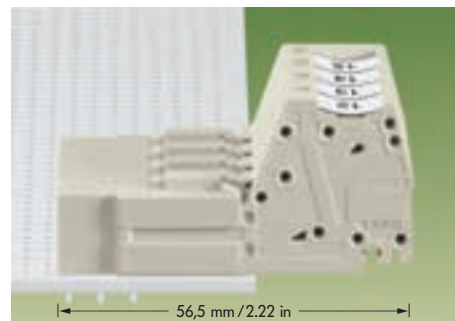

No. of poles	Item No.	No. of poles	Item No.
Headers with straight solder pins, 100 % protected against mismatching, light grey,		Headers with right angle solder pins, 100 % protected against mismatching, light grey,	
3 x solder pins	1 mm x 1.2 mm	3 x solder pins	1 mm x 1.2 mm
2	831-3602	2	831-3622
3	831-3603	3	831-3623
4	831-3604	4	831-3624
5	831-3605	5	831-3625
6	831-3606	6	831-3626
7	831-3607	7	831-3627
8	831-3608	8	831-3628

Note:

On request, headers with straight solder pins are also available with protection against positioning error on the PCB



Break or cut-off coding pin on the female connector . . .

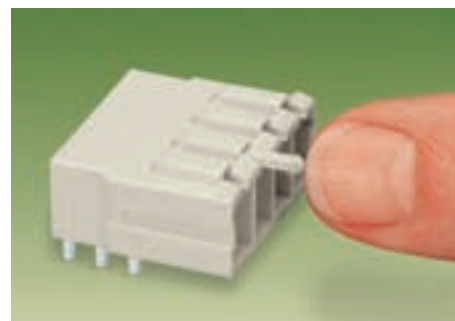

. . . Fit the coding pin into the connector (break first) so that the pin engages

Dimensions (in mm) Diameter of drilled hole: 1.7^{+0.1}mm L = (No. of poles - 1) x pin spacing + 10.5 mm

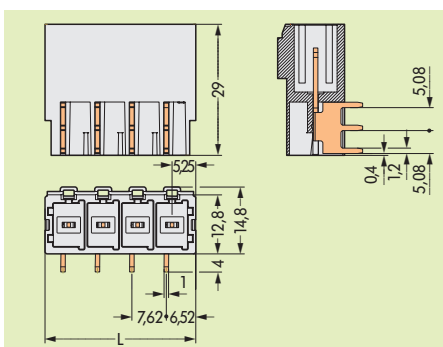
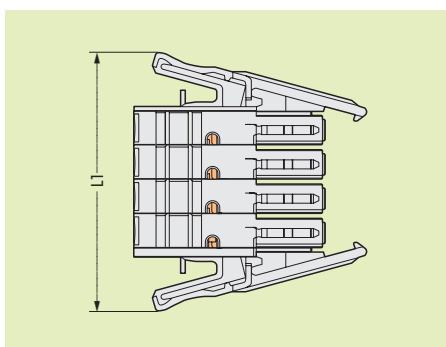

Printed female connector on request

*Further approvals with corresponding ratings can be found at www.wago.com

MULTI CONNECTION SYSTEM MAXI

Male Connectors, 100% Protected against Mismatching, Pin Spacing 7.62 mm / 0.3 in

CAGE CLAMP® S

VOLUME 2

Pin spacing 7.62 mm/0.3 in, light grey
0.5 – 6 (10) mm² ① AWG 20 – 8
800 V/8 kV/3 300/600 V, 42/5 A ②
I_N 41 A 300/600 V, 50/5 A ③

Pin spacing 7.62 mm/0.3 in, light grey
0.5 – 6 (10) mm² ① AWG 20 – 8
800 V/8 kV/3 300/600 V, 42/5 A ②
I_N 41 A 300/600 V, 50/5 A ③

* ② ③

* ② ③



① can be connected:
0.5 mm² – 10 mm² "s+f-st";
can be pushed in directly; 1.5 mm² – 10 mm² "s" and
1.5 mm² – 6 mm² "insulated ferrule, 12 mm/0.472 in"

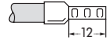

No. of poles	Item No.	No. of poles	Item No.
Male connectors with CAGE CLAMP® S connection, 100% protected against mismatching, with coding fingers, light grey		Male connectors with CAGE CLAMP® S connection, for DIN 35 rail mounting 100% protected against mismatching, with coding fingers, light grey	
2	831-3202	2	831-3202/007-000
3	831-3203	3	831-3203/007-000
4	831-3204	4	831-3204/007-000
5	831-3205	5	831-3205/007-000
6	831-3206	6	831-3206/007-000
7	831-3207	7	831-3207/007-000
8	831-3208	8	831-3208/007-000
Accessories			
Test plug, with cable 500 mm/1'7.7" Ø 2 mm/0.079 in, red 210-136		Test plug, with cable 500 mm/1'7.7" Ø 2 mm/0.079 in, red 210-136	
Marker card, 80 self-adhesive strips per card Height of marker strip 5 mm/0.197 in Marking 1 – 16 (100 x) 210-334/0762-0202		Marker card, 80 self-adhesive strips per card Height of marker strip 5 mm/0.197 in Marking 1 – 16 (100 x) 210-334/0762-0202	
For direct printing, please contact factory		For direct printing, please contact factory	
Marker strip, white, plain, on roll for center marking 11 mm/0.039 in wide 50 m 2009-110 300 m 2009-130		Marker strip, white, plain, on roll for center marking 11 mm/0.039 in wide 50 m 2009-110 300 m 2009-130	
DIN 35 carrier rail adapter, for snap-fit mounting to male connectors with CAGE CLAMP® S connection 831-137		Screwdriver with partially insulated shaft, (5.5 x 0.8) mm / (0.217 x 0.031) in 210-621	
Dimensions (in mm) L = (No. of poles - 1) x pin spacing + 9.5 mm			

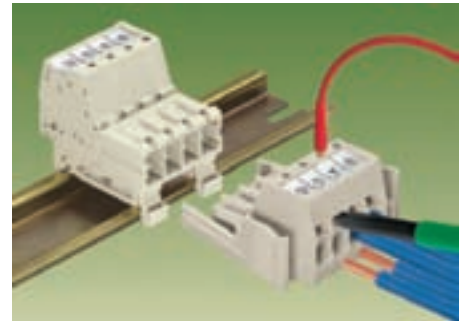

The new WAGO MULTI CONNECTION SYSTEM MAXI can be used as "high-power" sub-assemblies on carrier rails or printed circuit boards in such applications like drive technology, converters or power supply units.

Equipped with CAGE CLAMP® S connection up to AWG 10/ AWG 8 (6 mm²/10 mm²) ①, it handles a rated current of 41 A and has a pin spacing of 7.62 mm/0.3 in, which makes it ideally suited for such applications.

Product features

- 100% protected against mismatching
- Coding without the loss of poles
- Male and female connectors with CAGE CLAMP® S connection for all conductor types
Additional benefit: Time-saving push-in wiring of fine-stranded wires with ferrules
- Vibration proof - fast - maintenance free
- Male and female connectors with separate test slot for test plugs Ø 2.3 mm/0.091 in
- Pole marking using marker strips or direct printing

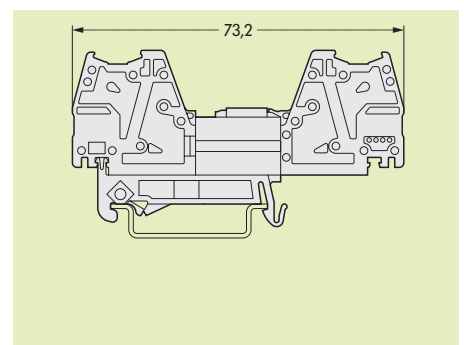
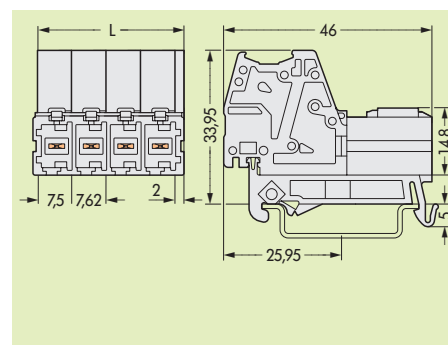
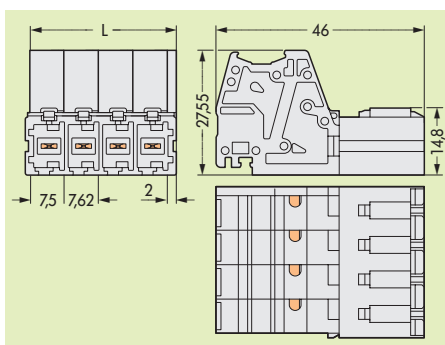

*Further approvals with corresponding ratings can be found at www.wago.com

MULTI CONNECTION SYSTEM MAXI

Female Connectors, 100% Protected against Mismatching, Pin Spacing 7.62 mm / 0.3 in

CAGE CLAMP® S

VOLUME 2

Pin spacing 7.62 mm/0.3 in, light grey 0.5 – 6 (10) mm ² ① AWG 20 – 8 800 V/8 kV/3 300/600 V, 42/5 A I _N 41 A	Pin spacing 7.62 mm/0.3 in, light grey 0.5 – 6 (10) mm ² ① AWG 20 – 8 800 V/8 kV/3 300/600 V, 42/5 A I _N 41 A	
---	---	--

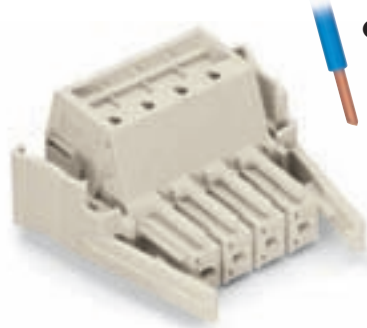

① can be connected:
 0.5 mm² – 10 mm² "s + f-st";
 can be pushed in directly: 1.5 mm² – 10 mm² "s" and
 1.5 mm² – 6 mm² "insulated ferrule, 12 mm/0.472 in"

No. of poles	Item No.	No. of poles	Item No.
Female connectors with CAGE CLAMP® S connection, 100% protected against mismatching, with coding fingers, light grey		Female connectors with CAGE CLAMP® S connection and locking device, 100% protected against mismatching, with coding fingers, light grey	
2	831-3102	2	831-3102/037-000
3	831-3103	3	831-3103/037-000
4	831-3104	4	831-3104/037-000
5	831-3105	5	831-3105/037-000
6	831-3106	6	831-3106/037-000
7	831-3107	7	831-3107/037-000
8	831-3108	8	831-3108/037-000

Accessories

Test plug, with cable 500 mm/1'77" 2 mm/0.079 in Ø, red 210-136	Test plug, with cable 500 mm/1'77" 2 mm/0.079 in Ø, red 210-136
Marker card, 80 self-adhesive strips per card Height of marker strip 5 mm/0197 in Marking 1 – 16 (100 x) 210-334/0762-0202 For direct printing, please contact factory	Marker card, 80 self-adhesive strips per card Height of marker strip 5 mm/0197 in Marking 1 – 16 (100 x) 210-334/0762-0202 For direct printing, please contact factory
Marker strip, white, plain, on roll for center marking 11 mm/0.039 in wide 50 m 2009-110 300 m 2009-130	Marker strip, white, plain, on roll for center marking 11 mm/0.039 in wide 50 m 2009-110 300 m 2009-130
Screwdriver with partially insulated shaft, (5.5 x 0.8) mm / (0.217 x 0.031) in 210-621	Screwdriver with partially insulated shaft, (5.5 x 0.8) mm / (0.217 x 0.031) in 210-621

Dimensions (in mm) L = (No. of poles - 1) x pin spacing + 9.5 mm L1 = L + 24.8 mm

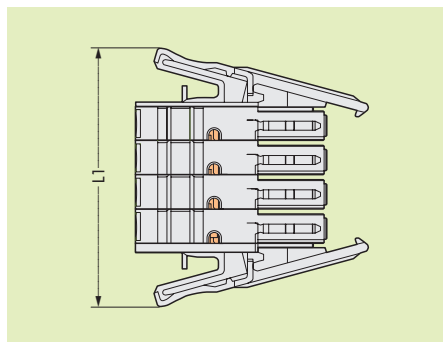
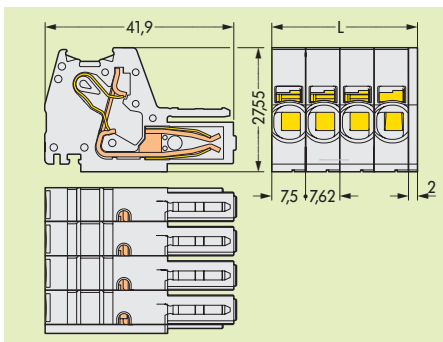

Operating Tools

VOLUME 2

Screwdriver acc. to DIN 5264,
for optimum handling
in terminal blocks and connectors

TOPJOB®  tool



Item No.	Pack.-unit pcs	Item No.	Pack.-unit pcs
Short screwdriver, with partially insulated shaft, blade 3.5 x 0.5 mm / 0.137 in x 0.020 in, suitable for series 260, 261, 262, 264, 280, 281, 869 210-657	1	TOPJOB®  tool with partially insulated shaft, Special blades 3.5 mm / 0.137 in and 5.5 mm / 0.217 in suitable for 2003 and 2005 Series multilevel installation terminal blocks 2009-310	1
Short angled screwdriver, with partially insulated shaft, blade 3.5 x 0.5 mm / 0.137 in x 0.020 in, particularly suitable for actuator and sensor terminal blocks of Series 280 and also for Series 260, 261, 262, 264, 280, 281, 869, 870, 880 210-658	1		

Application notes



The blade dimensions of the a. m. screwdrivers (DIN 5264) are particularly appropriate for easy operation of front-entry sensor and actuator terminal blocks of series 280.

Index of Item Nos.

Item No.	Page	Item No.	Page	Item No.	Page	Item No.	Page
Series 209		Series 222		231-903	78	250-205/350-604	55
209-105	11	222-412	42	231-905	78	250-206/350-604	55
209-183	27	222-415	42	231-907	78	250-207/350-604	55
209-184	27			231-910	78	250-208/350-604	55
		Series 231		231-2302/107-000	79	250-402/350-604	55
Series 210		231-129	68	231-2303/107-000	79	250-403/350-604	55
210-133	11	231-132/001-000/105-604	68	231-2304/107-000	79	250-404/350-604	55
210-136	4	231-132/001-000/105-604/997-405	68	231-2305/107-000	79	250-405/350-604	55
210-137	4	231-136/001-000/105-604	68	231-2306/107-000	79	250-406/350-604	55
		231-133/001-000/105-604	68	231-2307/107-000	79	250-407/350-604	55
210-281	11	231-133/001-000/105-604/997-405	68	231-2308/107-000	79	250-408/350-604	55
		231-134/001-000/105-604	68	231-2309/107-000	79		
210-331/0500-0103	57	231-134/001-000/105-604/997-407	68	231-2310/107-000	79		
210-331/0500-0104	57	231-135/001-000/105-604	68	231-2311/107-000	79		
210-332/0350-0202	57	231-135/001-000/105-604/997-407	68	231-2312/107-000	79	Series 258	
210-332/0350-0204	74	231-136/001-000/105-604	68	231-2313/107-000	79	258-150	48
210-332/0381-0202	74	231-136/001-000/105-604/997-407	68	231-2314/107-000	79	258-228	48
210-332/0381-0204	75	231-138/001-000/105-604	68	231-2315/107-000	79	258-297	48
210-332/0500-0202	58	231-138/001-000/105-604/997-407	68	231-2316/107-000	79	258-298	48
210-334	43	231-140/001-000/105-604	68			258-328	48
210-334/0762-0202	82	231-140/001-000/105-604/997-409	68	Series 236		258-350	48
		231-142/001-000/105-604/997-409	68	236-332	55	258-370	48
210-619	54	231-159	73	236-335	55		
210-620	57	231-307/107-000	79			Series 280	
210-621	31, 82	231-308/107-000	79	236-402/334-604	55	280-402	34
210-657	84	231-309/107-000	79	236-403/334-604	55	280-404	34
210-658	84	231-312/107-000	79	236-404/334-604	55	280-409	34
		231-314/107-000	79	236-405/334-604	55	280-415	34
		231-315/107-000	79	236-406/334-604	55		
		231-316/107-000	79			Series 282	
Series 211		231-337/108-000	79	Series 248		282-369	33
211-110	48	231-338/108-000	79	248-...	5		
211-111	48	231-339/108-000	79	Series 249		282-432	33
211-112	48	231-340/108-000	79	249-...	5	282-433	33
211-113	48	231-342/108-000	79	249-105	27	282-434	33
211-114	48	231-344/108-000	79	249-116	34	282-435	33
211-115	48	231-345/108-000	79	249-117	34	282-435/011-000	33
211-120	48	231-346/108-000	79	249-125	34	282-436	33
211-121	48			249-126	34	282-437	33
211-122	48	231-432/001-000/105-604	69	249-127	34	282-437/011-000	33
211-123	48	231-432/001-000/105-604/997-405	69			282-438	33
211-124	48	231-433/001-000/105-604	69	249-200	50	282-439	33
211-125	48	231-433/001-000/105-604/997-405	69	249-201	50	282-440	33
211-129	49	231-433/040-000	77	249-202	50		
211-150	49	231-434/001-000/105-604	69	249-203	50	Series 283	
211-151	49	231-434/001-000/105-604/997-407	69	249-204	50	283-404	31
211-155	49	231-435/001-000/105-604	69	249-205	50		
211-156	49	231-435/001-000/105-604/997-407	69	249-206	50	Series 285	
		231-436/001-000/105-604	69	249-207	50	285-134	31
		231-436/001-000/105-604/997-407	69	249-208	50	285-135	31
		231-438/001-000/105-604	69	249-209	50	285-137	31
		231-438/001-000/105-604/997-407	69	249-210	50	285-150	32
		231-440/001-000/105-604	69	249-217	50	285-154	32
		231-440/001-000/105-604/997-409	69	249-237	50	285-157	32
		231-442/001-000/105-604	69	249-238	50	285-172	32
		231-442/001-000/105-604/997-409	69	249-239	50		
		231-463/040-000	77	249-241	50	285-420	31
				249-242	50	285-421	31
		231-500	68	249-243	50	285-427	31
		231-537/108-000	79	249-244	50	285-435	31
		231-538/108-000	79	249-245	50	285-440	32
		231-539/108-000	79	249-246	50	285-441	32
		231-540/108-000	79	249-247	50	285-447	32
		231-542/108-000	79	249-248	50	285-450	32
		231-544/108-000	79	249-249	50		
		231-545/108-000	79	249-250	50		
		231-546/108-000	79			Series 250	
				250-202/350-604	55	250-202/350-604	55
		231-637/109-000	79	250-203/350-604	55	250-203/350-604	55
		231-638/109-000	79	250-204/350-604	55	250-204/350-604	55
		231-639/109-000	79				
		231-640/109-000	79				
		231-642/109-000	79				
		231-644/109-000	79				
		231-645/109-000	79				
		231-646/109-000	79				
		231-670	76				
		231-671	76				
		231-672	76				

Item No.	Page	Item No.	Page	Item No.	Page	Item No.	Page
Series 298		733-204	64	734-372	71	Series 745	
298-642	41	733-205	64	734-372/037-000	71	745-300	62
298-646	40	733-206	64			745-338	62
298-6...	40	733-207	64	734-420	72	745-340	62
		733-208	64	734-426	80	745-345	62
		733-210	64	734-427	80	745-380	62
		733-212	64	734-428	80	745-381	62
				734-429	80	745-382	62
Series 709				734-430	80	745-383	62
709-350	45			734-431	80	745-384	62
709-352	45			734-462	74	745-385	62
		Series 734		734-463	74	745-390	62
		734-114	70	734-464	74	745-391	62
		734-114/037-000	70	734-465	74	745-392	62
		734-126	80	734-466	74	745-393	62
		734-127	80	734-467	74	745-394	62
		734-128	80	734-468	74	745-395	62
		734-129	80	734-469	74		
		734-130	66	734-470	74	745-831	62
		734-132/105-604	66	734-472	74	745-833	62
		734-132/105-604/997-405	66	734-473	74	745-834	62
		734-133/105-604	66	734-474	74	745-837	62
		734-133/105-604/997-405	66	734-476	74	745-838	62
		734-134/105-604	66	734-478	74	745-841	62
		734-134/105-604/997-405	66	734-480	74	745-843	62
		734-135/105-604	66	734-484	74	745-844	62
		734-135/105-604/997-405	66			745-847	62
		734-136/105-604	66	734-502	75	745-848	62
		734-136/105-604/997-407	66	734-503	75		
		734-138/105-604	66	734-504	75	745-1352	63
		734-138/105-604/997-407	66	734-505	75	745-1353	63
		734-140/105-604	66	734-506	75	745-1354	63
		734-140/105-604/997-407	66	734-507	75	745-1355	63
		734-142/105-604	66	734-508	75	745-1356	63
		734-142/105-604/997-407	66	734-509	75	745-1357	63
		734-144	48	734-510	75	745-1358	63
		734-162/105-604	67	734-512	75	745-1359	63
		734-162/105-604/997-405	67	734-514	75	745-1360	63
		734-163/105-604	67	734-516	75	745-1362	63
		734-163/105-604/997-405	67	734-520	75		
		734-164/105-604	67	734-532	74	745-1402	63
		734-164/105-604/997-405	67	734-533	74	745-1403	63
		734-165/105-604	67	734-534	74	745-1404	63
		734-165/105-604/997-405	67	734-535	74	745-1405	63
		734-166/105-604	67	734-536	74	745-1406	63
		734-166/105-604/997-407	67	734-537	74	745-1407	63
		734-168/105-604	67	734-538	74	745-1408	63
		734-168/105-604/997-407	67	734-539	74	745-1409	63
		734-170/105-604	67	734-540	74	745-1410	63
		734-170/105-604/997-407	67	734-542	74	745-1412	63
		734-172/105-604	67	734-543	74	745-1415	63
		734-172/105-604/997-407	67	734-544	74	745-1453	63
		734-174	70	734-546	74	745-1454	63
				734-548	74	745-1455	63
		734-226	80	734-550	74	745-1456	63
		734-227	80	734-554	74	745-1457	63
		734-228	80	734-562	75	745-1458	63
		734-229	80	734-563	75	745-1459	63
		734-231	73	734-564	75	745-1460	63
				734-565	75	745-1462	63
		734-314	70	734-566	75		
Series 733		734-326	4	734-567	75	745-3100	60
733-102	64	734-327	4	734-568	75	745-3102	60
733-102/037-000	64	734-328	4	734-569	75	745-3103	60
733-103	64	734-329	4	734-570	75	745-3104	60
733-103/037-000	64	734-362	71	734-572	75	745-3105	60
733-104	64	734-362/037-000	71	734-574	75	745-3106	60
733-104/037-000	64	734-363	71	734-576	75	745-3107	60
733-105	64	734-363/037-000	71	734-580	75	745-3108	60
733-105/037-000	64	734-364	71			745-3109	60
733-106	64	734-364/037-000	71	Additional item nos.		745-3110	60
733-106/037-000	64	734-365	71	734-.../037-000	74	745-3112	60
733-107	64	734-365/037-000	71			745-3138	60
733-107/037-000	64	734-366	71			745-3152	61
733-108	64	734-366/037-000	71			745-3153	61
733-108/037-000	64	734-367	71	Series 735		745-3154	61
733-109/037-000	64	734-367/037-000	71	735-500	54	745-3155	61
733-110	64	734-368	71			745-3156	61
733-110/037-000	64	734-368/037-000	71			745-3157	61
733-111/037-000	64	734-369	71			745-3158	61
733-112	64	734-369/037-000	71			745-3159	61
733-112/037-000	64	734-370	71			745-3160	61
		734-370/037-000	71			745-3162	61
733-202	64						
733-203	64						

Item No.	Page	Item No.	Page	Item No.	Page	Item No.	Page
745-3202	61	769-242	36	790-300	45	806-205	58
745-3203	61	769-243	36	790-301	45	806-206	58
745-3204	61	769-251	34			806-207	58
745-3205	61	769-251/000-006	38			806-208	58
745-3206	61	769-257	34			806-209	58
745-3207	61					806-210	58
745-3208	61	769-317	36	Series 791		806-211	58
745-3209	61	769-318	36	791-107	44	806-212	58
745-3210	61	769-319	36	791-111	44		
745-3212	61	769-320	34	791-117	44	806-902	58
745-3252	61	769-321	34	791-124	44	806-903	58
745-3253	61					806-904	58
745-3254	61	769-402	38			806-905	58
745-3255	61	769-434	35			806-906	58
745-3256	61	769-435	34	Series 793		806-907	58
745-3257	61	769-470	34	793-4...	4	806-908	58
745-3258	61	769-471	34	793-5...	4	806-909	58
745-3259	61	769-472	34			806-910	58
745-3260	61					806-911	58
745-3262	61	769-501	40			806-912	58
		769-501/000-006	40				
		769-501/000-016	40	Series 794		Additional item nos.	
745-3801	60	769-502	40	794-4...	4	806- ... /000-006	58
745-3803	60	769-502/000-006	40	794-5...	4	806- ... /000-012	58
745-3804	60	769-502/000-016	40				
745-3807	60	769-503	40				
745-3808	60	769-503/000-006	40	Series 804		Series 807	
		769-503/000-016	40	804-102	57	807-0090/0101-0100	49
Additional item nos.		769-504	40	804-103	57		
745- ... /005-000	63	769-504/000-006	40	804-104	57		
745- ... /000-006	61	769-504/000-016	40	804-105	57		
745- ... /000-009	61	769-506	40	804-106	57	Series 831	
745- ... /000-016	61	769-506/000-006	40	804-107	57	831-137	82
745- ... /000-017	61	769-506/000-016	40	804-108	57		
		769-512	41	804-109	57	831-3102	83
Series 746		769-512/000-006	41	804-110	57	831-3102/037-000	83
746-2302	59	769-512/000-016	41	804-111	57	831-3103	83
746-2303	59	769-513	41	804-112	57	831-3103/037-000	83
746-2304	59	769-513/000-006	41	804-113	57	831-3104	83
746-2305	59	769-513/000-016	41	804-114	57	831-3104/037-000	83
746-2306	59	769-515	41	804-115	57	831-3105	83
746-2307	59	769-515/000-006	41	804-116	57	831-3105/037-000	83
746-2308	59	769-515/000-016	41			831-3106	83
746-2309	59			804-302	57	831-3106/037-000	83
746-2310	59			804-303	57	831-3107	83
746-2311	59	Series 773		804-304	57	831-3107/037-000	83
746-2312	59	773-173	43	804-305	57	831-3108	83
				804-306	57	831-3108/037-000	83
Additional item nos.		773-332	43	804-307	57		
746- ... /000-006	59			804-308	57	831-3202	82
746- ... /000-009	59	773-514	43	804-309	57	831-3202/007-000	82
746- ... /000-016	59			804-310	57	831-3203	82
746- ... /000-017	59			804-311	57	831-3203/007-000	82
				804-312	57	831-3204	82
				Additional item nos.		831-3204/007-000	82
Series 769		Series 777		804- ... /000-005	57	831-3205	82
769-101/000-006	38	777-303	11	804- ... /000-006	57	831-3205/007-000	82
769-102/000-006	38			804- ... /000-012	57	831-3206	82
769-103/000-006	38			804- ... /000-017	57	831-3206/007-000	82
769-103/000-038	38	Series 780				831-3207	82
769-103/000-039	38	780-452	34	Series 806		831-3207/007-000	82
769-104/000-006	38	780-453	34	806-102	58	831-3208	82
769-105/000-006	38	780-454	34	806-103	58	831-3208/007-000	82
769-105/000-038	38	780-455	34	806-104	58		
769-105/000-039	38	780-456	34	806-105	58	831-3602	81
769-106/000-006	38	780-457	34	806-106	58	831-3603	81
769-107/000-006	38	780-458	34	806-107	58	831-3604	81
769-108/000-006	38			806-108	58	831-3605	81
769-109/000-006	38			806-109	58	831-3606	81
769-110/000-006	38			806-110	58	831-3607	81
769-111/000-006	38	Series 790		806-111	58	831-3608	81
769-112/000-006	38	790-110	44	806-112	58		
769-113/000-006	38	790-112	44			831-3622	81
769-114/000-006	38	790-114	44	806-202	58	831-3623	81
769-115/000-006	38			806-203	58	831-3624	81
769-171/000-006	38			806-204	58	831-3625	81
769-176/000-006	38					831-3626	81
						831-3627	81
						831-3628	81

Item No.	Page	Item No.	Page	Item No.	Page	Item No.	Page
Series 2001		2002-549	4	2002-2951	18	2004-433	11
2001-511	4	2002-552	5	2002-2952	18	2004-434	11
2001-549	4	2002-553	5	2002-2954	18	2004-435	11
2001-552	5	2002-554	5	2002-2958	18	2004-436	11
2001-553	5	2002-555	5	2002-2959	18	2004-437	11
2001-554	5	2002-556	5	2002-2971	18	2004-438	11
2001-555	5	2002-557	5	2002-2972	18	2004-439	11
2001-556	5	2002-558	5	2002-2974	18	2004-440	11
2001-557	5	2002-559	5	2002-2991	18		
2001-558	5	2002-560	5	2002-2992	18	2004-511	4
2001-559	5					2004-541	4
2001-560	5	2002-1201	20	2002-3201	7	2004-549	4
		2002-1211/1000-0410	20	2002-3203	7	2004-552	5
2001-1201	19	2002-1211/1000-0411	20	2002-3204	7	2004-553	5
2001-1211/1000-0410	19	2002-1291	20	2002-3207	7	2004-554	5
2001-1211/1000-0411	19	2002-1292	20	2002-3208	7	2004-555	5
2001-1291	19			2002-3209	7		
2001-1292	19	2002-1301	20	2002-3211/1000-0410	24		
		2002-1311/1000-0410	20	2002-3211/1000-0411	24		
2001-1301	19	2002-1301/1000-0411	20	2002-3211/1000-0675	24	Series 2005	
2001-1311/1000-0410	19	2002-1321/1000-0413	20	2002-3211/1000-0676	24	2005-7641	11
2001-1311/1000-0411	19	2002-1321/1000-0434	20	2002-3212/1000-0673	25	2005-7642	11
2001-1321/1000-0413	19	2002-1391	20	2002-3212/1000-0674	25	2005-7645	11
2001-1321/1000-0434	19	2002-1392	20	2002-3221/1000-0413	25	2005-7646	11
2001-1391	19			2002-3221/1000-0434	25	2005-7649	11
2001-1392	19	2002-1401	20	2002-3217	7	2005-7692	11
		2002-1411/1000-0410	20	2002-3218	7		
2001-1401	19	2002-1411/1000-0411	20	2002-3227	7		
2001-1411/1000-0410	19	2002-1421/1000-0413	20	2002-3228	7		
2001-1411/1000-0411	19	2002-1421/1000-0434	20	2002-3231	7		
2001-1421/1000-0413	19	2002-1441	2	2002-3233	7		
2001-1421/1000-0434	19	2002-1491	2	2002-3234	7	Series 2006	
2001-1441	2	2002-1492	2	2002-3237	7	2006-0405/0011-000	26
				2002-3238	7	2006-7111	12
		2002-1601	16	2002-3239	7	2006-7114	12
		2002-1602	16	2002-3247	7	2006-7192	12
		2002-1604	16	2002-3248	7		
		2002-1671	16	2002-3257	7		
		2002-1672	16	2002-3258	7		
		2002-1674	16	2002-3291	7		
		2002-1691	16	2002-3292	7		
		2002-1692	16				
				2002-6301	3	Series 2009	
		2002-1801	17	2002-6302	3	2009-110	4
		2002-1802	17	2002-6304	3	2009-115	5
		2002-1804	17	2002-6307	3	2009-130	4
		2002-1871	17	2002-6391	3	2009-174	3
		2002-1872	17	2002-6392	3	2009-182	3
		2002-1874	17			2009-184	50
		2002-1891	17	2002-6401	3	2009-191	27
		2002-1892	17	2002-6402	3	2009-192	27
				2002-6404	3	2009-193	27
		2002-2201	6	2002-6407	3	2009-196	27
		2002-2202	6				
		2002-2203	6	2002-7111	12	2009-304	11
		2002-2204	6	2002-7114	12	2009-305	11
		2002-2207	6	2002-7192	12	2009-310	84
		2002-2208	6				
		2002-2209	6			2009-412	26
		2002-2211/1000-0410	22			2009-414	26
		2002-2211/1000-0411	22			2009-416	26
		2002-2213/1000-0487	23	Series 2003			
		2002-2213/1000-0488	23	2003-7641	10		
		2002-2214/1000-0489	23	2003-7642	10	Series 2010	
		2002-2214/1000-0490	23	2003-7645	10	2010-100	27
		2002-2214/1000-0491	22	2003-7646	10		
		2002-2214/1000-0492	22	2003-7649	10	2010-0405/0011-000	26
		2002-2217	6	2003-7692	10		
		2002-2227	6				
		2002-2221/1000-0413	23				
		2002-2221/1000-0434	23				
		2002-2231	6				
		2002-2232	6	Series 2004			
		2002-2233	6	2004-402	11		
		2002-2234	6	2004-403	11	Series 2016	
		2002-2237	6	2004-404	11	2016-100	27
		2002-2238	6	2004-405	11		
		2002-2239	6	2004-406	11	2016-0405/0011-000	26
		2002-2247	6	2004-407	11		
		2002-2257	6	2004-408	11	2016-1207	10
		2002-2291	6	2004-409	11		
		2002-2292	6	2004-410	11	2016-7111	12
				2004-0405/0011-000	26	2016-7114	12
						2016-7192	12
2002-511	4						
2002-541	4						

Item No.	Page	Item No.	Page	Item No.	Page	Item No.	Page

Notes

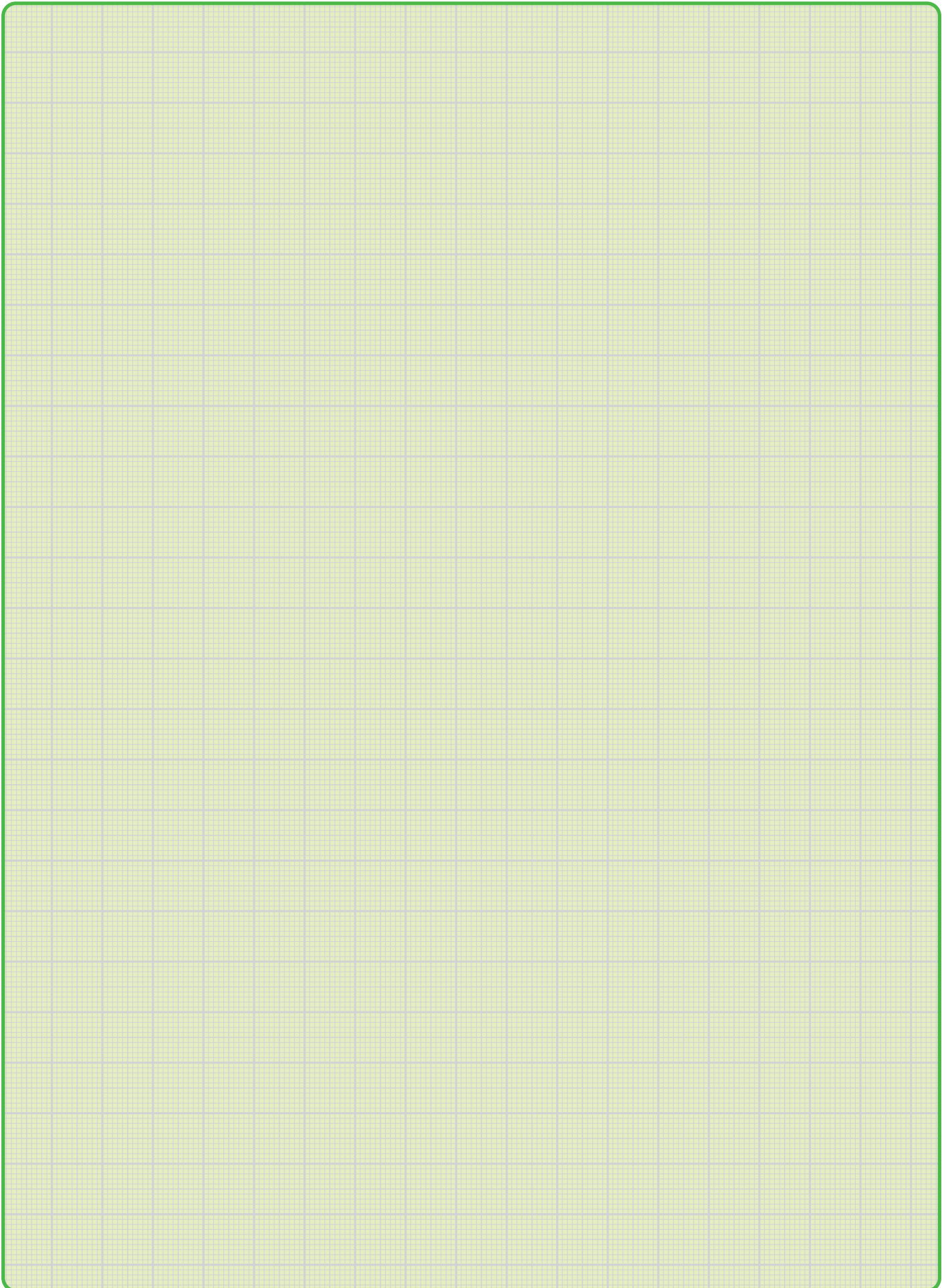

Notes

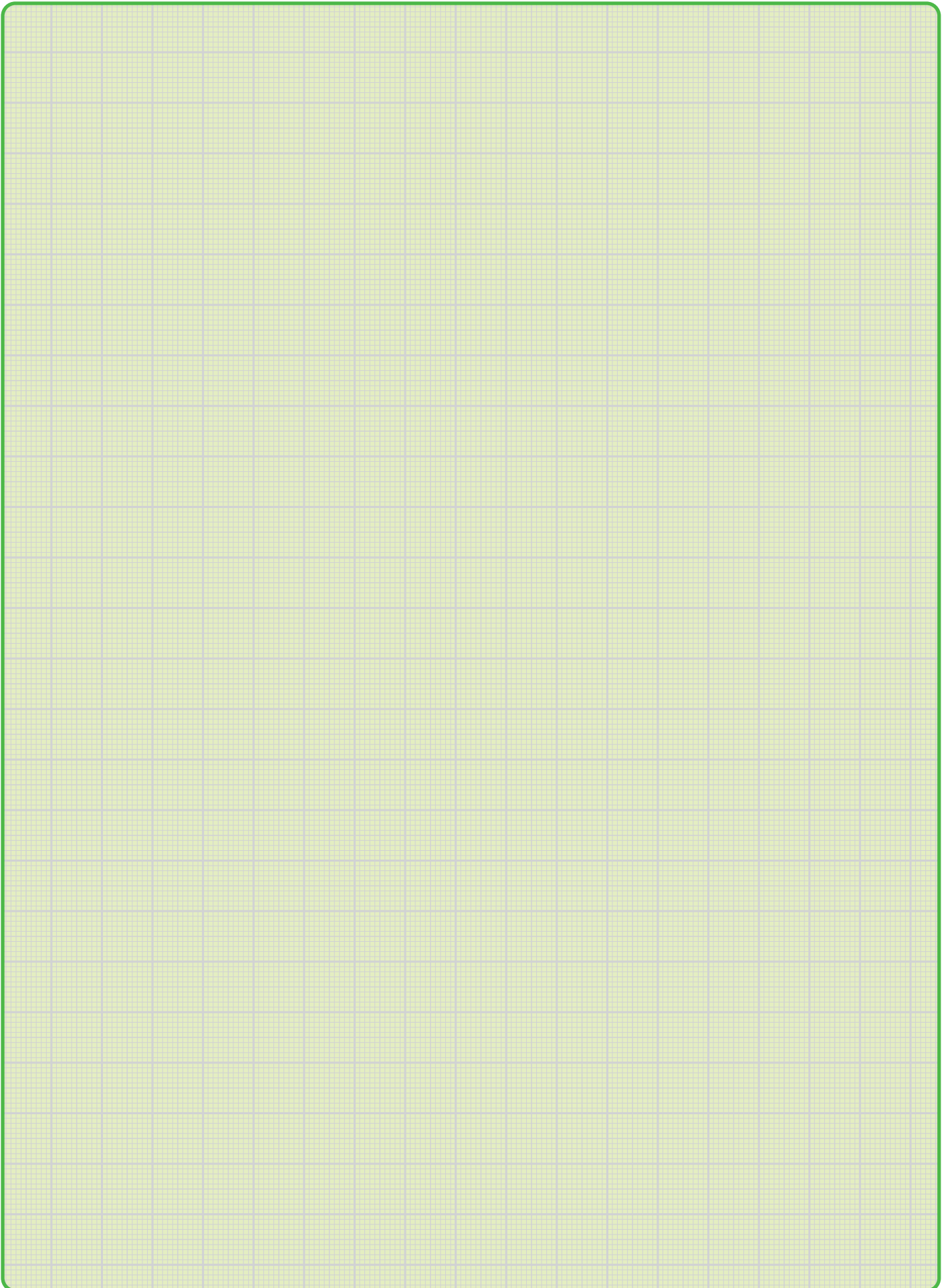

Notes

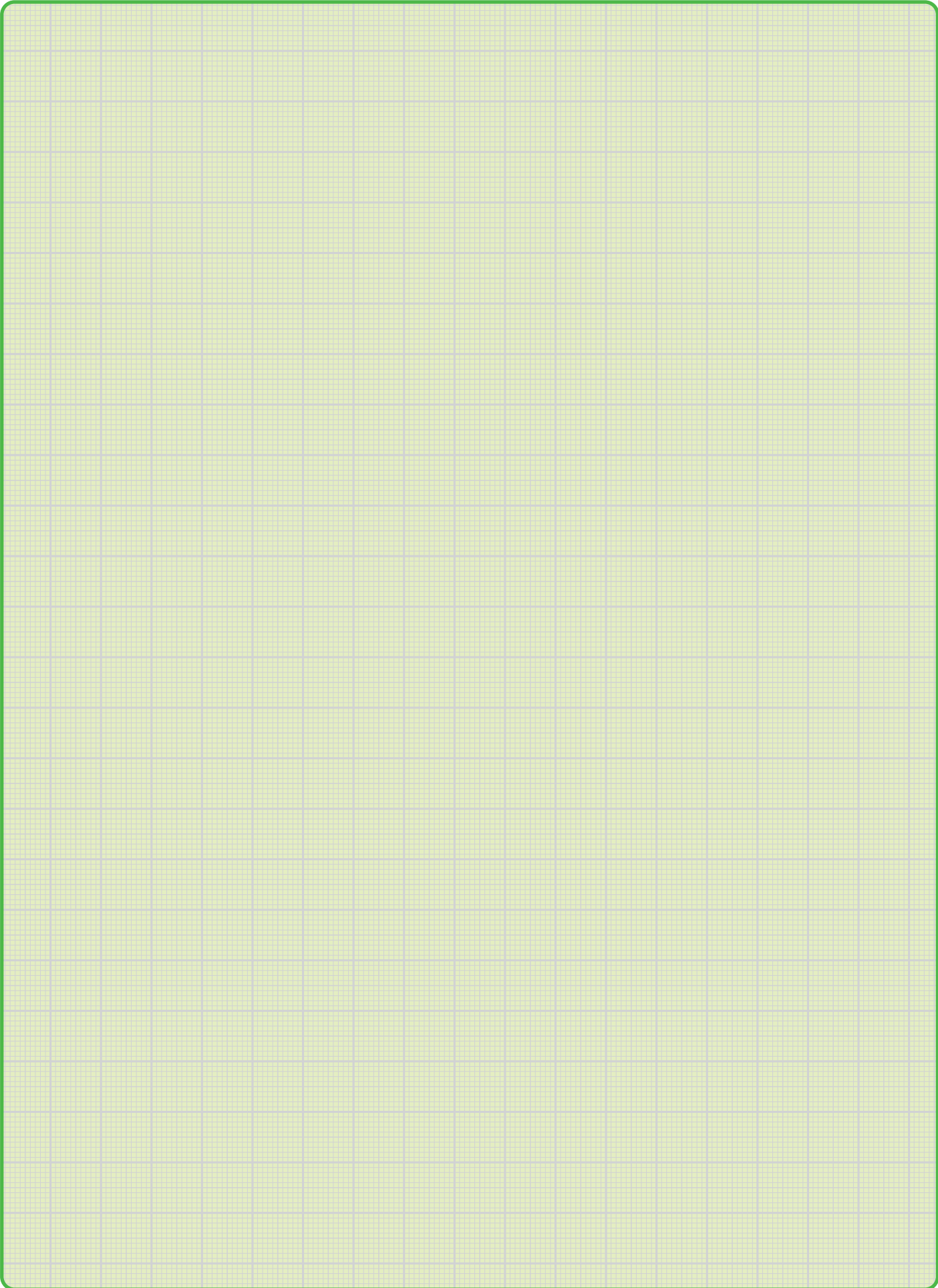

Notes

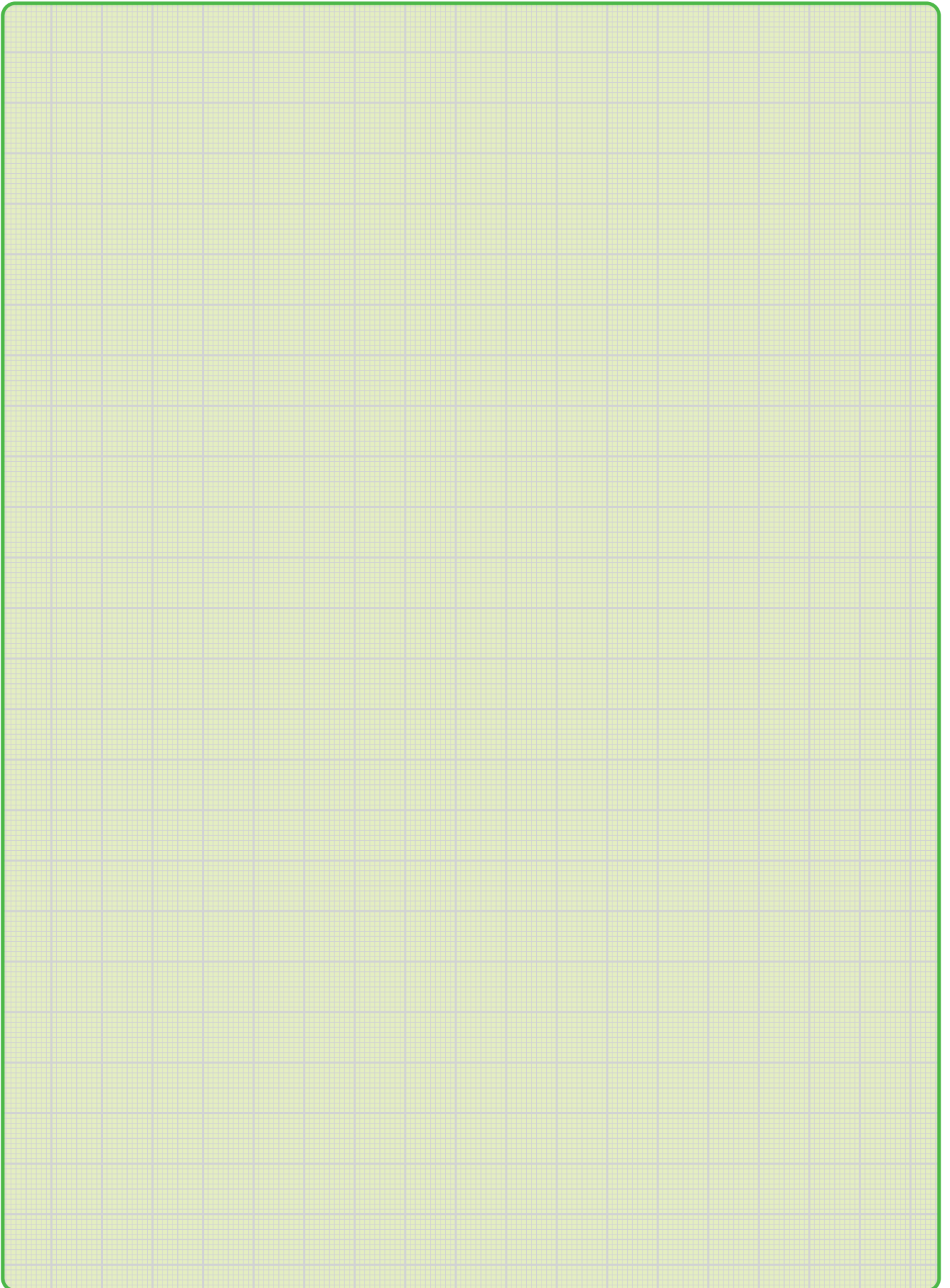

WAGO Worldwide

Argentina

Bruno Schillig S.A.
Arenales 4030, B1604CFD
Florida, PBA
Phone +54 11 4730 1100
Fax +54 11 4761 7244
robertor@schillig.com.ar

Australia

NHP ELECTRICAL ENGINEERING
PRODUCTS PTY LTD
43-67 River Street
Richmond, Victoria, 3121
P.O. Box 199
Phone +61 3 9429 2999
Fax +61 3 9429 1075
export@wago.com

Austria

WAGO Kontakttechnik Ges.m.b.H.
Laxenburger Straße 244
1230 Wien
Phone +43 1 6150780
Fax +43 1 6150775
info.at@wago.com

Belgium

WAGO Kontakttechnik
Excelsiorlaan 11
1930 Zaventem
Phone +32 2 7179090
Fax +32 2 7179099
info-be@wago.com

Bosnia and Herzegovina

please contact WAGO Bulgaria

SC_Technik doo
Kadić Mahala 47
Bosnia-Herzegovina
Phone +387 35 821815
Fax +387 35 821816
sc_technik@yahoo.de

Brasil

WAGO Eletroeletrônicos Ltda
Rua Américo Simões 1470
São Roque da Chave
Itupeva SP Brasil 13295-000
Phone +55 11 4591 0199
Fax +55 11 4591 0190
info.br@wago.com

Bulgaria

WAGO Kontakttechnik GmbH & Co. KG
Representative Office Sofia Bulgaria
Twardischki Prohod 21, ap.5
1404 Sofia
Phone +359 2 489 46 10
Fax +359 2 859 21 31
info-BG@wago.com

RIM Project Ltd.
Probuda - 12 A str., et. 7
Sofia
Bulgaria
Phone +359 2 9310666
Fax +359 2 9313839
office@rim-bg.com

Canada

WAGO CORPORATION
N120 W19129 Freistadt Road
Germantown, WI 53022
Phone +1 262 255 6222
Fax +1 262 255 3232
Toll-Free: 1-800 DIN Rail (346-7245)
info.us@wago.com

Chile

Desimat Chile
Av Puerto Vespuccio 9670
Pudahuel Santiago
Phone +56 2 7470152
Fax +56 2 7470153
ventaschile@desimat.cl

China

WAGO ELECTRONIC (TIANJIN) Co. LTD
No.5, Quan Hui Road
Wuqing Development Area
Tianjin 301700
Phone +86 22 59617688
Fax +86 22 59617668
info-cn@wago.com

- Companies and Representations -

Columbia

T.H.L. Ltda.
Cra. 49 B # 91-33
Bogotá
Phone +57 1 621 85 50
Fax +57 1 621 60 28
ventas-thl@thltda.com

Croatia

M.B.A. d.o.o. za trgovinu i zastupanje
Frana Supila 5
51211 Matulji HR
Phone +00385 51 275-736
Fax +00385 51 275-066
mba@ri.htnet.hr

Czech Republic

WAGO Elektro spol. sr. o.
Nad lesem 21
14700 Praha 4 - Hodkovicky
61400 Brno - Husovice
Phone +420 261 090 143
Fax +420 261 090 144
info.cz@wago.com

Denmark

WAGO Danmark
Filial of WAGO Kontakttechnik GmbH & Co. KG
Lejrvej 29
3500 Værløse
Phone +45 44 357777
Fax +45 44 357787
salg.dk@wago.com

Ecuador

INSETEC CIA. LTDA.
El Zurriago 177 y El Vengador
P.O. Box 17-16-016
Quito
Phone +593 2 2 26 91 48
Fax +593 2 2 46 18 33
g.castro@insetec.com.ec

Egypt

IBN Engineering Instrumentation & Control
71 a El Shaheed Ahmed Hamdi St.
King Faisal, Giza
Phone +20 2 7214350
Fax +20 2 7221709
sales@ibnengineering.com

Estland

Eltarko OÜ
Laki 14 - 502
10621 Tallinn
Phone +372 651 7731
Fax +372 651 7786
andres@eltarko.ee

Finland

WAGO Kontakttechnik GmbH & Co. KG
Filial i Finland
Vellamonkatu 30 B
00550 Helsinki
Phone +358 9 7744 060
Fax +358 9 7744 0660
export@wago.com

France

WAGO CONTACT S.A.
Paris Nord 2
83 Rue des Chardonnerets
B.P. 55065 - Tremblay en France
95947 - ROISSY CDG CEDEX
Phone +33 1 48172590
Fax +33 1 48632520
info-fr@wago.com

Germany

WAGO Kontakttechnik GmbH & Co. KG
Postfach 28 80 32385 Minden
Hansastraße 27
32423 Minden
Phone +49 571 887-0
Fax +49 571 887-169
info@wago.com

Great Britain

WAGO Limited
Triton Park, Swift Valley Industrial Estate
RUGBY
Warwickshire, CV21 1SG
Phone +44 1788 568008
Fax +44 1788 568050
uksales@wago.com

Greece

PANAGIOTIS SP. DIMOULAS - BIOMAT
Kritis Str. 26
10439 Athen
Phone +30 210 883 3337
Fax +30 210 883 4436
export@wago.com

Hong Kong

National Concord Eng., Ltd.
Unit A-B, 5/F.
Southeast Industrial Building
611-619 Castle Peak Road
Tsuen Wan, N.T.
Phone +852 24292611
Fax +852 24292164
sales@nce.com.hk

Hungary

WAGO Hungária KFT
Ipari Park, Gyár u. 2
2040 Budapest
Phone +36 23 502-170
Fax +36 23 502-166
info@wago.hu

Iceland

S. Gudjonsson ehf.
Audbrekku 9-11
202 Kopavagur
Phone +354 520-4500
Fax +354 520-4501
export@wago.com

India

WAGO & CONTROLS (INDIA) LTD.
C-27, Sector-58, Phase-III
Noida-201 301
Gautam Budh Nagar (U.P)
Phone +91 120 2 580409 10
Fax +91 120 2 580081
info@wagoindia.com

Indonesia

PT. Timur Agungmulia Kencana
Graha Mulxindo Lt. 2
Jl. Sultan Iskandar Muda No. 88 L
Jakarta Selatan 12240
Phone +62 21 722 8888
Fax +62 21 722 8565
tak_electric@cbn.net.id

Iran

Patsa Industry
No. 2 Bahar St.
South Shiraz Ave
P.O. Box.: 15875-1698
14369 Tehran
Phone +98 21 8726869
Fax +98 21 8719666
export@wago.com

Ireland

Drives & Controls
Unit F4, Riverview Business Park
Nangor Road
Dublin 12
Phone +353 1 4604474
Fax +353 1 4604507
wago@drivesandcontrols.ie

Israel

Comtel Israel Electronic Solutions Ltd.
Bet Hapaamon
20 Hataas Street
P.O.Box 66
44425 Kefar-Saba
Phone +972 9 76 77 240
Fax +972 9 76 77 243
sales@comtel.co.il

Italy

WAGO ELETTRONICA SRL
Via Vittoria, 5/b
40068 San Lazzaro di Savena (BO)
Phone +39 051 6272170
Fax +39 051 6272174
info-ita@wago.com

Japan

WAGO Co. of JAPAN Ltd.
Nittetsu ND-Tower Building 4F
Kameido 1-5-7
Koto-Ku
Tokyo 136-0071
Phone +81 3 5627 2050
Fax +81 3 5627 2055
info-jp@wago.com

Korea

Hankuk Sangsa Co. &
Mahani Electric Co. Ltd.
576-8, Bisan-2dong, Dongan-Ku
Anyang-City
Kyungki-Do., 431-821
Phone +82 31 4633300
Fax +82 31 4633398 9
export@wago.com

Kosovo

please contact WAGO Bulgaria

Kuwait

Kuwait Controls Company
Al Sour Street, Above Lufthansa Airline
Safat Kuwait 13062
Phone +965 822 522
Fax +965 243 3698

Latvia

INSTABALT LATVIA SIA
Vestienas iela 6
Riga, LV-1035
Phone +371 790 1188
Fax +371 790 1180
info@instabalt.lv

Lebanon

G.T.C.
Antonine Project - Block G
P.O.BOX 70-1096 Antelias
Lebanon
Phone +961 4 521 029
Fax +961 4 521 029
rgemayel@inco.com.lb

Lithuania

INSTABALT LIT UAB
Savanorių 187
Vilnius, 2053
Phone +370 52 322 295
Fax +370 52 322 247
info@instabalt.lt

Luxembourg

please contact WAGO Belgium

Macedonia

please contact WAGO Bulgaria

Malaysia

WAGO Representative Office Malaysia
No 806, Block A4, Leisure Commerce Square,
No 9, Jalan PJS 8/9, 46150 Petaling Jaya,
Selangor Darul Ehsan, Malaysia
Phone +60 3 7877 1776
Fax +60 3 7877 2776
kian.guan.tan@wago.com

Mexico

WAGO CORPORATION
N120 W19129 Freistadt Road
Germantown, WI 53022
Phone +52 55 26 44 69 16
Fax +52 55 26 44 69 15
Toll-Free: 001-800-309-5975
info.mx@wago.com

Netherlands

WAGO Nederland
van Leeuwenhoekstraat 20-1
3846 CB Harderwijk
Phone +31 341 439039
Fax +31 341 439030
info-nl@wago.com

New Zealand

NHP NZ
7 Lockhart Place
Mt Wellington
New Zealand
Phone +64 9 2761967
Fax +64 9 2761992
export@wago.com

Norway

WAGO Norge NUF
Jerikoveien 20
1067 Oslo
Phone +47 22 30 94 50
Fax +47 22 30 94 51
info.no@wago.com

Peru

Desimat Peru
Av. E. Salazar Barreto No. 280
Surco - Lima 33
Phone +51 1 2731892
Fax +51 1 2720054
export@wago.com

Philippines

WAGO Electronic Pte Ltd
10 Upper Aljunied Link, # 04-04
York International, Industrial Building
Singapore 367904
Phone +65 62866776
Fax +65 62842425
info.sing@wago.com

Poland

WAGO ELWAG sp. z o. o.
ul. Piękna 58 a
50-506 Wrocław
Phone +48 71 3604670 78
Fax +48 71 3604699
wago.elwag@wago.com

Portugal

MORGADO & CA. LDA - SEDE
Estrada Exterior da
Circunvalação 3558/3560
Apartado 1057
4435 Rio Tinto
Phone +351 22 9770600
Fax +351 22 9770699
export@wago.com

Romania

please contact WAGO Bulgaria

VDR & Servicii srl
Str. Valerii Braniște, nr. 60, ap.1, sector 3
Romania
Phone +40 21 3225074/76
Fax +40 21 3225075
office@componente-automatizari.ro

ETA Automatizari Industriale SRL

Str. Gh. Dima Nr. 1
Romania
Phone +40 256 294608
Fax +40 256 294609
automatizari@eta2u.ro

Russia

ООО ВАГО Контакт Рус
ул. Лесная, 43, офис 329
127055 Москва
Phone +7 499 9786670
Fax +7 499 9786690
info@wago.ru

Saudi Arabia

Al Quraishi Electrical Services of S. A.
P.O. Box 7386
Dammam-31462
Phone +966 3 85 725 37
Fax +966 3 85 725 41
export@wago.com

Serbia

please contact WAGO Bulgaria

Singapore

WAGO Electronic Pte Ltd
10 Upper Aljunied Link, # 04-04
York International, Industrial Building
Singapore 367904
Phone +65 62866776
Fax +65 62842425
info.sing@wago.com

Slovakia

WAGO Elektrik spol.s r. o
Odborárska 52
83102 Bratislava
Phone +421 2 44458301
Fax +421 2 44458301
export@wago.com

South Africa

Shorrock Automation (Pty) Ltd
Postnet Suite # 219
Private Bag X 8, Elardus Park
0047 PRETORIA
Phone +27 12 3454449
Fax +27 12 3455145
sales@shorrock.co.za

Spain

DICOMAT S.L.
Avda. de la Industria, 36
Apartado Correos, 1.178
28108-Alcobendas (Madrid)
Phone +34 91 6621362 (6 lines)
Fax +34 91 6610089
madrid@dicomat-asetyc.com

Sweden

WAGO Sverige
WAGO Kontaktechnik GmbH
Tyskland Filial
Box 639, 17527 Järfälla
Datavägen 9 A, 17543 Järfälla
Phone +46 858410680
Fax +46 858410699
info.se@wago.com

Switzerland

WAGO CONTACT SA
Rte. de l Industrie 19
Case Postale 168
1564 Domdidier
Phone +41/26 676 75 86 (Phone German)
Fax +41/26 676 75 88 (Phone Italian)
info.switzerland@wago.com

Syria

Zahabi Co.
8/5 Shouhadaa St., P.O. Box 8262
Aleppo
Phone +963 21 21 22 235 / 6
Fax +963 21 21 24 768
export@wago.com

Taiwan R.O.C.

WAGO Taiwan
8/F., No. 48, Jing-An Road
Chung-Ho City, 23556
Taipei Hsien. T a i w a n
Phone +886 2 2244 2569
Fax +886 2 2244 2658

Thailand

WAGO Representative Office Thailand
4th Floor, KS Building
213/6-8 Rachada-Phisek Road
Dingdaeng Bangkok 10320
Phone +66 2 6935611
Fax +66 2 6935612
pote.c@wago.com

Turkey

WAGO Elektronik Sanayi ve Ticaret Ltd. Şti.
Barbaros Mahallesi Mimar Sinan Caddesi No 169
34746 Yenısahra - Kadıköy İstanbul
Turkey
Phone +90 216 472 1133
Fax +90 216 472 9910
info.tr@wago.com

United Arab Emirates (UAE)

Binghalib Engineering Ent.
Trading Division
Al Khabeshi Area
P.O. Box 14743
Dubai
Phone +971 4 2674555
Fax +971 4 2674117
export@wago.com

USA

WAGO Corporation
N120 W19129 Freistadt Road
Germantown, WI 53022
Phone +1 262 255 6222
Fax +1 262 255 3232
Toll-Free: 1-800-DIN Rail (346-7245)
info.us@wago.com

Venezuela

PETROBORNAS, C.A.
Av. Principal UD 304-Zona Ind. Los Pinos
C.C. Los Pinos-Local E
8015-Puerto Ordaz-Edo, Bolivar
Phone +58 286 994 3406
Fax +58 286 994 5249
info@petrobornas.net

Vietnam

please contact WAGO Singapore



X-ON Electronics

Largest Supplier of Electrical and Electronic Components

Click to view similar products for [amphenol manufacturer](#):

Other Similar products are found below :

[MS27473P14B18S](#) [GTS02R20-15P-025-116](#) [GTC030-40-68SZ-025-RDS-LC](#) [ACC02E28-51S-003-B30-LC](#) [TV06RL-13-35AD](#) [TV06RL-13-98BD](#) [TV06RL-13-35SD-LC](#) [TV06RL-13-35SD](#) [TV06RL-13-98SD-LC](#) [TV06RL-13-98SD](#) [TVP00RW-23-53AD](#) [100-007-213-002-001](#) [TV06RW-25-90AE](#) [97-3108B16S-5PW-417](#) [PT06J20-24SW](#) [97-3108B16S-4PY-417](#) [97-3108B16S-4PX-417](#) [97-3108B16S-5PY-417](#) [97-3108B16S-4PW-417](#) [CS-DSDMDB37MF-025](#) [97-3108B16S-5PZ-417](#) [TV06RW-25-46AE](#) [TVS07RF-21-16AA](#) [TVS07RF-21-39BA](#) [CF-5A9013-04N](#) [CF-6A4615-06N](#) [GTC02R32-17S-025-RDS](#) [GTC02R32-17S-025-RDS-LC](#) [GTC02R32-17S-025-LC](#) [PT06SE-24-61P\(LC\)](#) [GTC06-22-13SW](#) [GTC06-22-13SY](#) [GTS06G-36-10S](#) [GTC06-22-13S-025-B30-LC](#) [GTC06-22-13SW-025-LC](#) [GTC06-22-13SX-025-B30](#) [GTC06-22-13SZ-025](#) [GTC06-22-13SZ-025-LC](#) [GTC06-22-13S-025-LC](#) [GTC06-22-13SW-025-B30](#) [GTC06-22-13SW-025-B30-LC](#) [GTC06-22-13SX-025-B30-LC](#) [GTC06-22-13SX-025-LC](#) [GTC06-22-13SY-025-B30](#) [GTC06-22-13SY-025-B30-LC](#) [GTC06-22-13SY-025-LC](#) [GTC06-22-13SZ-025-B30](#) [GTC06-22-13SZ-025-B30-LC](#) [GTC06-22-13SW-025](#) [GTC06-22-13SX-025](#)