

# Surface Mount Terminal Blocks with Push-Buttons

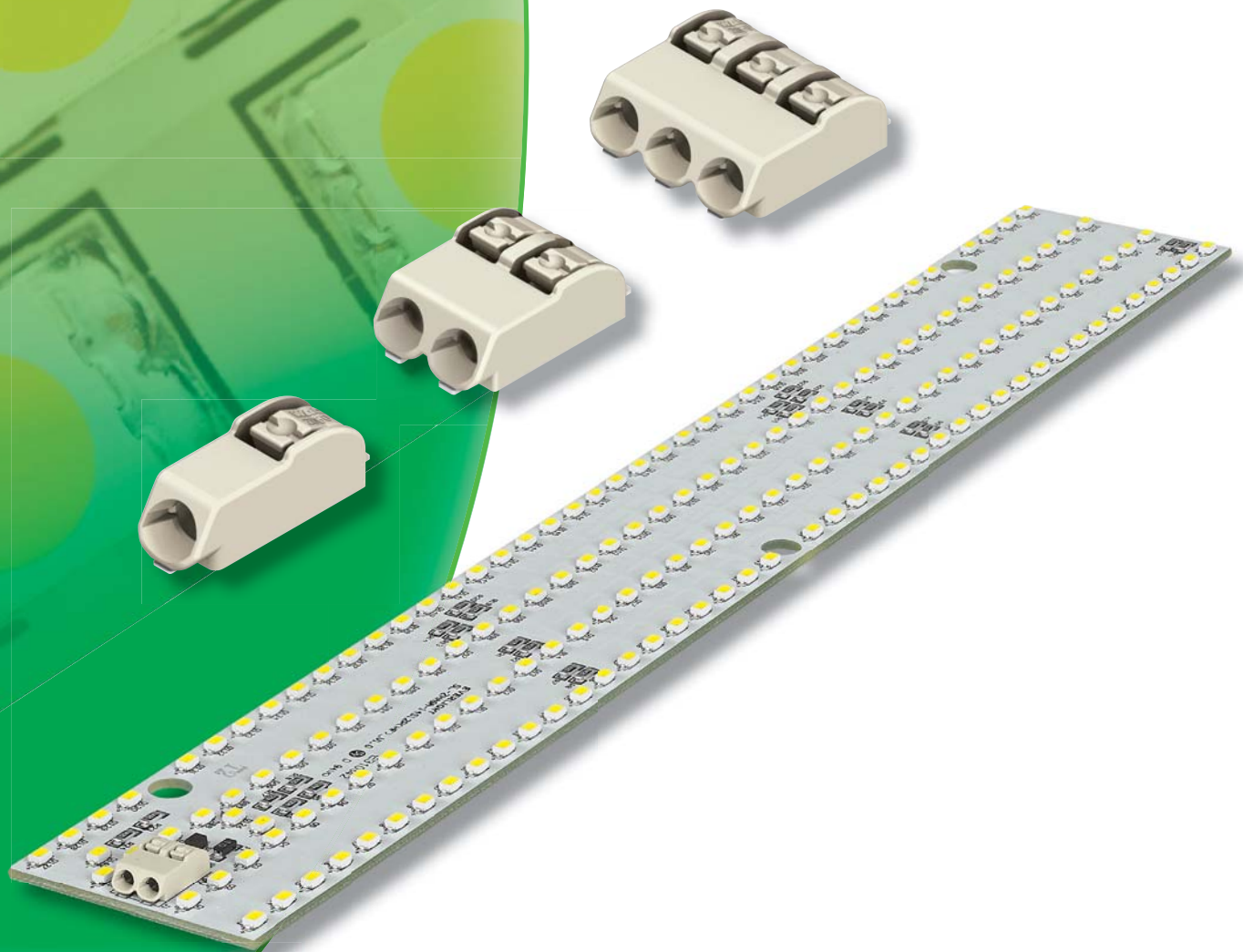

# Surface Mount Terminal Blocks with Push-Buttons

## Pin Spacing 4 mm, 8 mm

### 2060 Series



- Surface mount terminal blocks with CAGE CLAMP®S connection and push-buttons
- Direct push-in of solid conductors
- Push button for connection of stranded conductors, and for removal of all wire types
- A total height of only 4.5mm helps minimize shadowing in LED applications
- Packaged in tape-and-reel for automated SMT processes
- Large flat area for easy pick-n-place
- Wiring ports with balcony design – creates "lead-in" for ease of wiring, even at a slight angle

#### Technical data:

Pin Spacing	4 mm 0.157 in			8 mm 0.314 in		
	IEC/EN 60664-1			IEC/EN 60664-1		
Rating per	III	III	II	III	III	II
Overvoltage category	3	2	2	3	2	2
Pollution degree	63 V	160 V	320 V	63 V	160 V	320 V
Rated voltage	2.5 kV	2.5 kV	2.5 kV	2.5 kV	2.5 kV	2.5 kV
Rated surge voltage	9 A	9 A	9 A	9 A	9 A	9 A
Nominal current	UL/CSA			UL/CSA		
Approvals per	600 V			-		
Rated voltage, 1-pole	250 V			600 V		
Rated voltage for 2-poles and more	9 A			9 A		
Nominal current UL	6 A			6 A		
Nominal current CSA						

#### Conductor data:

Connection technology	CAGE CLAMP®S
Conductor size: solid	0.20 – 0.75 mm <sup>2</sup>
Conductor size: fine-stranded	0.20 – 0.75 mm <sup>2</sup>
AWG	24 – 18
Strip length	6 – 7 mm / 0.24 – 0.28 in
Conductor entry angle	0° to PCB

#### Material data:

Material group	I
Insulating material	Glass fiber-reinforced polyphthalamide (PPA-GF)
Flammability rating per UL 94	V0
Lower/Upper temperature limit	-60°C/+105°C*
Contact material	Copper alloy
Contact plating	Tin-plated

#### Application notes:

Suitable for lead-free, reflow-soldering profiles acc. to DIN EN 61760-1 and IEC 60068-2-58 up to max. 260°C peak temperature. Due to customer specific variables (e.g., component configuration and orientation, type of soldering machine, solder paste), it is recommended that trial runs are conducted to ensure product and process compatibility under actual manufacturing conditions.

Recommendation for stencil: Material thickness, 150 µm. Stencil layout identical to pad layout.

Depending on reflow soldering temperatures and times, color deviations may occur for light gray connectors. These deviations will have no impact on functionality.

\*For applications requiring upper temperature limit higher than 105°C, contact factory. Restrictions may apply.

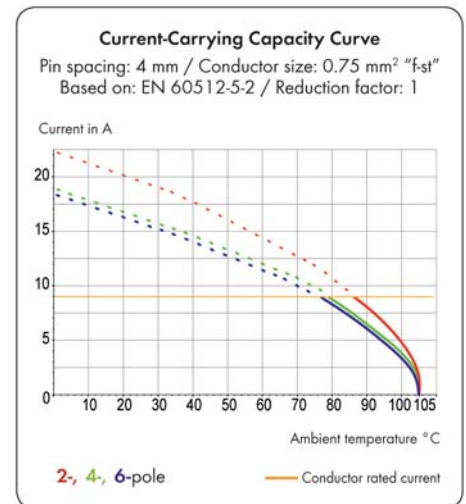

#### 2060 Series accessories:

Operating Tools	233-335
Shorting Bar	2000-402
Interconnecting Link	2060-90x

# Surface Mount Terminal Blocks with Push-Buttons 2060 Series

CAGE CLAMP®

Pin spacing 4 mm / 0.157 in			Pin spacing 8 mm / 0.314 in	
0.2 - 0.75 mm <sup>2</sup>	AWG 24 - 18		0.2 - 0.75 mm <sup>2</sup>	AWG 24 - 18
160 V/2.5 kV/2 9 A	1p	2 - 3p	630 V/6 kV/2 9 A	600 V/9 A
	600 V/9 A	250 V/9 A		600 V/6 A
	600 V/6 A	250 V/6 A		

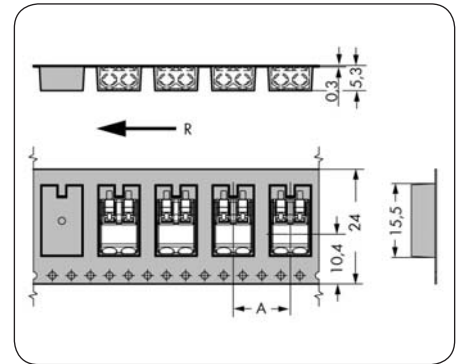
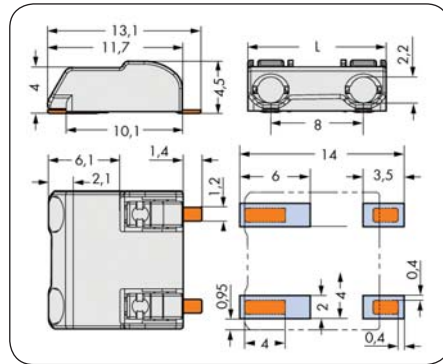
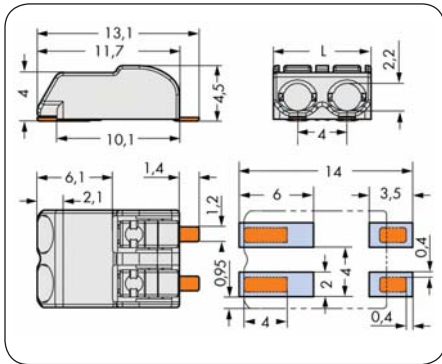

L = (pole no. x pin spacing) - 0.1 mm

R = Feed direction  
A = (pole no. x pin spacing) + 4 mm

Pole No.	Item No.	Pack Unit/ Pieces per Reel	Pole No.	Item No.	Pack Unit/ Pieces per Reel
Surface mount terminal blocks with push-buttons in tape-and-reel packaging			Surface mount terminal blocks with push-buttons in tape-and-reel packaging		
1	2060-401/998-404	○ 1500	2	2060-802/998-404	○ 1000
2	2060-402/998-404	○ 1000			
3	2060-403/998-404	○ 750			
1	2060-421/998-404	● 1500			
2	2060-422/998-404	● 1000			
3	2060-423/998-404	● 750			
Reel diameter: 330 mm			Reel diameter: 330 mm		



Inserting solid conductors via push-in termination.



Inserting/removing fine-stranded conductors by lightly pressing on push-button (e.g., using a 233-335 operating tool or a ball point pen).



2000-402 Shorting Bar - used to complete the circuit at the end of a string of linear LED modules, e.g., insert with WAGO logo facing upward, and at a slight angle so the bottom of the housing clears the bottom edge of the terminal block wire entry opening.

# Connecting Links for Surface Mount Terminal Blocks with Push-Buttons

## Pin Spacing 4 mm

### 2060 Series



- Connecting link simplifies LED circuit board assembly
- Easy push-in termination and disconnection without push-button actuation
- For board-to-board connections using 2060 series terminal blocks
- Eliminates manual wiring between boards or LED modules

#### Technical data:

Pin Spacing	4 mm 0.157 in				
Rating per	IEC/EN 60664-1				
Overvoltage category	III	III	II		
Pollution degree	3	2	2		
Rated voltage	63 V	160 V	320 V		
Rated surge voltage	2.5 kV	2.5 kV	2.5 kV		
Nominal current	9 A	9 A	9 A		
Approvals per	UL/cUL				
Rated voltage	250 V				
Nominal current UL	9 A				
Nominal current CSA	6 A				



#### Material data:

Material group	I
Insulating material	Polyamide 6.6 (PA 6.6)
Flammability rating per UL 94	V0
Lower/Upper temperature limit	-60°C/+105°C
Contact material	Copper alloy
Contact plating	Silver-plated

# Connecting Links for Surface Mount Terminal Blocks with Push-Buttons

## 2060 Series

CAGE CLAMP® S

<b>Pin spacing 4 mm / 0.157 in</b>	
160 V/2.5 kV/2 9 A	250 V/9 A 
	250 V/6 A 

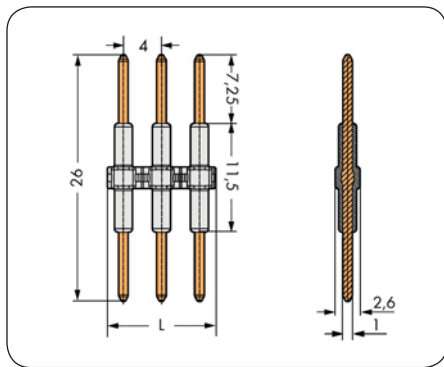

L = (pole no. x pin spacing) - 0.6 mm

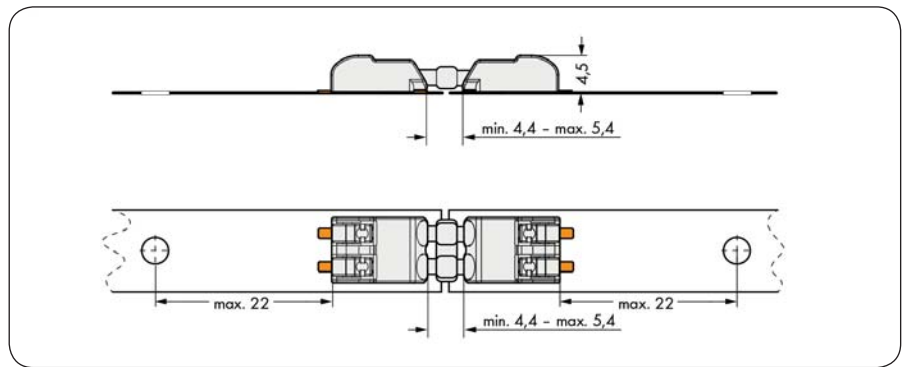

Pole No.	Item No.	Pack Unit
<b>Connecting link for surface mount terminal blocks with push-buttons</b>		
1	2060-901	
2	2060-902	
3	2060-903	



Inserting the connecting link into terminal block.

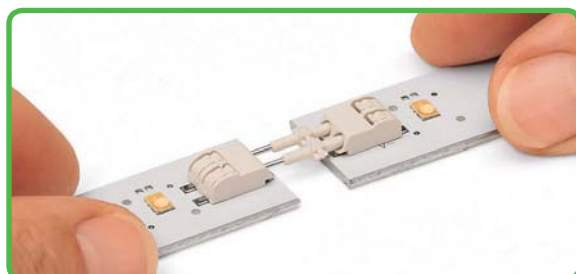

Assembly: Place PCB on a flat surface and insert links into terminal blocks on adjoining PCBs.  
Disassembly: Pull PCBs apart.  
(Maximum 10 connections/disconnections)

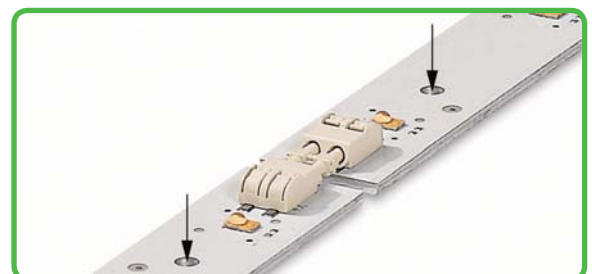

The PCBs must be secured (see figure above).



Surface Mount Terminal Blocks with Push-Buttons  
 Pin Spacing 6 mm  
 2061 Series

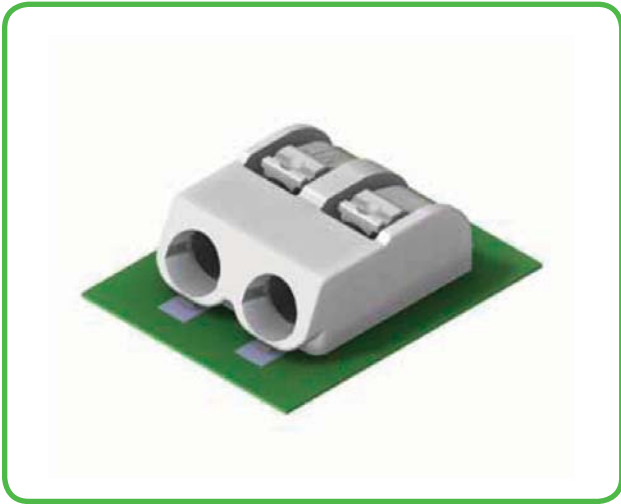

- Expanded wire range for power connection to LED modules with integrated drivers, or electronic devices for industrial use
- Surface mount terminal blocks with CAGE CLAMP®S connection and push-buttons
- A total height of only 5.6mm helps reduce shadowing in LED applications
- Push-in termination of solid conductors
- Available in tape-and-reel packaging for automated assembly

Technical data:

Pin Spacing	6 mm 0.24 in		
Rating per	IEC/EN 60664-1		
Overvoltage category	III	III	II
Pollution degree	3	2	2
Rated voltage	250 V	320 V	630 V
Rated surge voltage	4 kV	4 kV	4 kV
Nominal current	12 A	12 A	12 A
Approvals per	UL*		
Usegroup UL 1059	B	C	D
Rated voltage for 1-pole			
Rated voltage for 2-poles and more			
Nominal current UL			

Conductor data:

Connection technology	CAGE CLAMP®S
Conductor size: solid	0.5 - 1.5 mm <sup>2</sup>
Conductor size: fine-stranded	0.5 - 1.5 mm <sup>2</sup>
AWG	22 - 16
Strip length	6 - 8 mm / 0.24 - 0.31 in
Conductor entry angle	0° to PCB

Material data:

Material group	I
Insulating material	Glass fiber-reinforced polyphthalamide (PPA-GF)
Flammability rating per UL 94	V0
Lower/Upper temperature limit	-60°C/+105°C
Clamping spring material	Copper alloy
Contact plating	Tin-plated

2061 Series accessories:

Operating Tools	233-335
-----------------	---------

Application notes:

Suitable for lead-free, reflow-soldering profiles acc. to DIN EN 61760-1 and IEC 60068-2-58 up to max. 260°C peak temperature. Due to customer specific variables (e.g., component configuration and orientation, type of soldering machine, solder paste), it is recommended that trial runs are conducted to ensure product and process compatibility under actual manufacturing conditions.

Recommendation for stencil: Material thickness, 150 µm. Stencil layout identical to pad layout.

\*UL certification pending.

Surface Mount Terminal Blocks with Push-Buttons  
2061 Series

Pin spacing 6 mm / 0.24 in	
0.5 - 1.5 mm <sup>2</sup> 320 V/4 kV/2 12 A	AWG 22 - 16

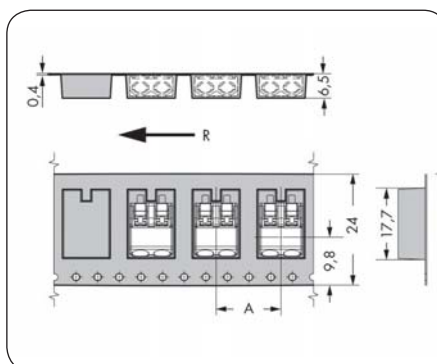
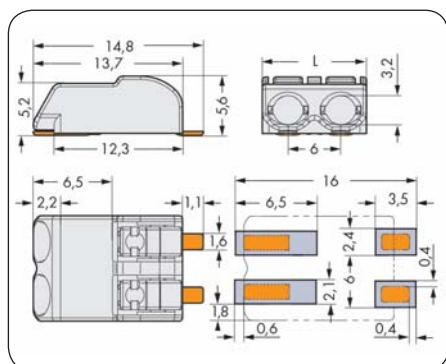

L = (pole no. x 6mm) - 0.3 mm

R = Feed direction  
A = (pole no. x 6mm) + 4mm

Pole No.	Item No.
Surface mount terminal blocks with push-buttons in tape-and-reel packaging	
1	2061-601/998-404
2	2061-602/998-404
3	2061-603/998-404
Reel diameter: 330 mm	



Inserting solid conductors via push-in termination.



Inserting/removing fine-stranded conductors by lightly pressing on push-button (e.g., using a 233-335 operating tool).

## WAGO Service Worldwide

### Germany

WAGO Kontakttechnik  
Minden  
Tel. ++49/571/887/0  
Fax ++49/571/887/169

### Austria

WAGO Kontakttechnik  
Wien  
Tel. ++43/1/615/07/80  
Fax ++43/1/615/07/75

### Belgium

WAGO Kontakttechnik  
Zaventem  
Tel. ++32/2/7/17/90/90  
Fax ++32/2/7/17/90/99

### China

WAGO ELECTRONIC Co. Ltd.  
Tianjin  
Tel ++86/22/59617688  
Fax ++86/22/59617668

### England

WAGO, Ltd.  
Rugby  
Tel. ++44/1788/568008  
Fax ++44/1788/568050

### France

WAGO CONTACT S.A.  
Paris  
Tel. ++33/148172590  
Fax ++33/148632520

### Italy

WAGO ELETTRONICA SRL  
Casalecchio di Reno (BO)  
Tel. ++39/051/6132112  
Fax ++39/051/6272174

### Japan

WAGO Co. of JAPAN Ltd.  
Tokyo  
Tel. ++81/3/5627/2050  
Fax ++81/3/5627/2055

### Poland

WAGO ELWAG sp. z o. o.  
Wroclaw  
Tel. ++48/71/3604670/78  
Fax ++48/71/3604699

### Singapore

WAGO Electronic Pte. Ltd.  
Singapore  
Tel. ++65/62866776  
Fax ++65/62842425

### Switzerland

WAGO CONTACT SA  
Domdidier  
Tel. ++41/26/676/75/86  
Fax ++65/26/676/75/01

### Mexico

WAGO Corporation  
Queretaro  
Tel. 001/800/309/5975  
+ 52/442/221/5946  
Fax + 52/442/221/5063

### Canada

WAGO Corporation  
Tel. 800/DIN Rail (346-7245)  
Fax 262/255-3232  
www.wago.ca

WAGO Corporation  
N120 W19129 Freistadt Road  
Germantown, Wisconsin 53022  
Telephone: 800 / DIN Rail (346-7245)  
Fax: 262 / 255-3232  
info.us@wago.com  
www.wago.us

**WAGO**<sup>®</sup>  
INNOVATIVE CONNECTIONS



## X-ON Electronics

Largest Supplier of Electrical and Electronic Components

*Click to view similar products for [wago manufacturer](#):*

Other Similar products are found below :

[750-460](#) [231-118/026-000](#) [231-303/026-000](#) [231-620/019-000](#) [257-403](#) [280-438](#) [280-831](#) [284-624](#) [210-111](#) [231-303/037-000](#) [231-446/001-000\\_NR](#) [232-216/026-000](#) [234-510](#) [264-726](#) [280-339](#) [0283-0671](#) [830-800/000-305](#) [750-512](#) [750-455](#) [51251782](#) [286-312](#) [713-1428/107-000](#) [731-138/048-000](#) [750-459](#) [750-517](#) [750-602](#) [793-3505](#) [826-172](#) [859-304](#) [280-335](#) [231-535/001-000](#) [2604-1105](#) [2604-1106](#) [2604-1504](#) [2606-1103/020-000](#) [2624-1103](#) [2626-3103/020-000](#) [821-104](#) [713-1107](#) [852-1411](#) [2106-1307](#) [2116-5307](#) [832-1205](#) [832-3604](#) [2009-110](#) [281-512/281-501](#) [286-336](#) [750-421](#) [750-838](#) [753-559](#)